

HARVARD UNIVERSITY.

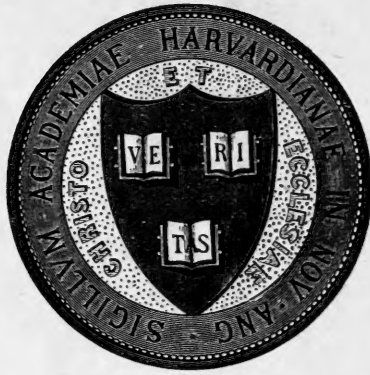

LIBRARY

OF THE

MUSEUM OF COMPARATIVE ZOÖLOGY

55,773

BEQUEST OF

WILLIAM BREWSTER

December 4, 1920.

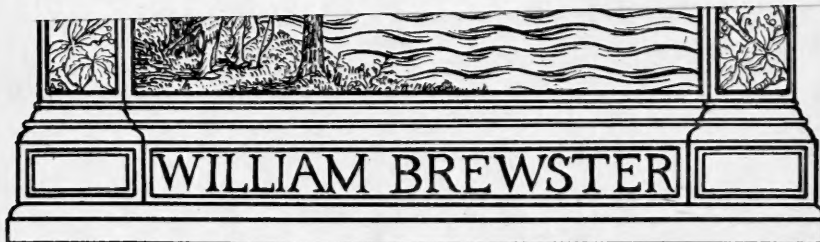

DEC 4 1920





RECREATION

A MONTHLY MAGAZINE DEVOTED TO EVERYTHING THE
NAME IMPLIES

VOLUME XX
JANUARY TO JUNE, 1904

G. O. SHIELDS (Coquina), Editor and Manager

NEW YORK
23 West 24th Street
1904
C.

13/11/19

YRABEJ
YFOJON SIMOJOM
CEAMBOOIBUJBO

COPYRIGHT, 1904, BY G. O. SHIELDS

INDEX TO VOLUME XX

	PAGE
"Voila! de Track".....	FRONTISPIECE
The Passing of Le Premier. Illustrated.....	CHARLES H. SAWYER 3
Juno, the Retriever.....	JAMES L. LANCASTER 7
Lines to the Hound. Poem.....	STACY E. BAKER 8
Ben's Russian Cousin. Illustrated.....	BARON PAUL TCHERKASSOV 9
Luck to the Hunter. Poem.....	MAUD M. HUEY 11
A New Star in the Art World. Illustrated.....	JOHN M. LEAHY 13
A Bear When a Buck Was Due. Illustrated.....	DR. C. N. BALLARD 15
Old Bill Gray's Story. Poem.....	JAMES B. ADAMS 16
Bounce, the Undertaker. Illustrated.....	MRS. LILLIE PLEAS 17
The Cowboy's Song. Poem.....	C. T. L. 18
One of Those Flowing Bowles. Illustrated.....	H. P. GILLETTE 19
By the Hardest.....	AMOS GRAYSON 21
Kit, the Tale of a Mule. Illustrated.....	FRANK S. ELLSWORTH 23
A Deer Accident.....	B. BOULDER 25
The 1903 Register. Poem.....	DR. J. S. KENNEDY 26
Antoine's Caribou.....	E. W. PARKER 27
Men of the Sun and Rain. Poem.....	R. B. NATTRASS 27
Mountain Badger. Illustrated.....	ALLAN BROOKS 28
Hiking in Rizal.....	CHAS. H. STONE 29
The New Army Rifle. Illustrated.....	31
Our and Somebody's Else Buck.....	FALCON 33
Recreation. Poem.....	NED NATE 35
Bud Moose Bugged.....	H. B. BROWN 36
The Owllet's Flight. Poem.....	S. H. M. 39
A Sharp Foreboding.....	C. H. FURLONG 40
A Day in the Rockies.....	BRUCE LEMMON 42
Adventure with a Coyote.....	HOWARD CARL 44
Imagine the Thrill of Jumping Over Stumps, Rocks and Other Obstacles on a Narrow Trail! FRONTISPIECE	
Hunting White Goats in the Selkirks.....	ELEANOR SCHAVOIR 85
Photographing in the Canadian Rockies. Illustrated.....	G. O. SHIELDS 89
The True Story of the Nez Perce War.....	H. B. NORTON 99
Fishing. Poem.....	EMMA G. CURTIS 101
A Pioneer's Adventure.....	A. A. BRIGGS 103
The Enchanters. Poem.....	GEORGE E. WINKLER 104
Down the Arbuckle River.....	F. W. PORTER 105
Antoine's Cat.....	E. W. PARKER 107
Take Us Afar. Poem.....	JEANNETTE CAMPBELL 108
A Pioneer Reminiscence.....	MISS M. L. SUTTON 109
Buffalo Hunting in Kansas.....	STUBB 111
The Haunted Mountain.....	MOSES THOMPSON, JR. 113
The Pawnee Uprising of 1859.....	HOWARD W. BELL 115
Hiawatha. Poem.....	JABOX 117
The Hudson Bay Company.....	S. A. PADDOCK 118
Veneered Human Nature.....	GRANT WALLACE 120
Sea Trout Galore.....	GOLD DUST 122
An Impson Valley Fox Hunt.....	R. J. LONG 123
A Master of Theory.....	G. A. MACK 125
The Other 2 Men Pushed on with 4 Dogs.....	FRONTISPIECE
A Tale of Alaskan Hardships.....	W. J. 171
Where the White Goats Get Their Salt. Illustrated.....	G. O. SHIELDS 175
The Sage Grouse.....	CHARLES S. MOODY 177
Bears and Things.....	FRANK MOSSMAN 179
An Eye for An Eye. Illustrated.....	MELEAGRO 181
The Modern Squirrel Hunter. Poem.....	JOHN L. WOODBURY 183
A Tale of the Woods.....	CHARLES T. MURRAY 184
A Florida Fishing Party.....	E. M. LEETE 187
Captain Joe Muffrau. Poem.....	H. W. BRADLEY 188
Baiting a Bear.....	WILLIAM J. LAMPTON 189
Early Days on the Yakima.....	J. E. NEWTON 191
How Sam Flynn Was Cured of Office Seeking.....	JENNIE P. BUFORD 193
The Trumpeter Swan. Illustrated.....	ALLAN BROOKS 194
How I Lost My Gun.....	OTTO VON STOCKHOUSEN 195
Signs of Spring. Poem.....	E. C. M. RICHARDS 196
The Dissolution of Abijah Dusenbury.....	DR. G. A. MACK 197
On a Russian River. Illustrated.....	BARON PAUL TCHERKASSOV 199
My Trip to Wood's Canyon.....	EDWARD CASHMAN 201
The Regeneration of Windy.....	CHARLES A. HARMON 205
Fishing After Dark.....	MAY MCHENRY 207
His Change of View. Poem.....	CANDICE A. BRAMBLE 208
A Pilfering Grizzly.....	FRANK R. GROVER 209
The Mustelle Family at Home.....	FRONTISPIECE
Some Adventures of Minnie Mustelle, the Mink. Illustrated.....	H. B. BROWN 255
The Praxis of Salmon Angling.....	E. J. MYERS 260
Red Breasted Merganser. Illustrated.....	ALLAN BROOKS 270
Wild Animals and Birds in the Northwest. Illustrated.....	G. O. SHIELDS 271
The Brown Towhee. Illustrated.....	DR. B. W. EVERMANN 277

	PAGE
Whip-Poor-Will. Poem.....	F. A. JOHNSON 279
Joe Bedore of St. Clair Flats. Poem.....	H. W. BBADLEY 281
In the Coast Range.....	D. E. WYNKOOP 282
How to Build a Mackinac Boat. Illustrated.....	FRED A. HUNT 285
The Troubles of 2 Tenderfeet.....	KLATTOWA 287
His Imaginary Buffalo Faced About and Raised Up, Fully 8 Feet High.....	FRONTISPIECE
A Race With a Grizzly.....	M. C. H. 331
Casting in Sluggish Waters.....	E. J. MYERS 333
How to Build a Log Canoe. Illustrated.....	G. O. SHIELDS 335
Rondeau. Poem.....	E. E. WEBSTER 337
How George Killed the Bear. Illustrated.....	W. S. BRITT 339
The Ozarks. Poem.....	L. C. ELERICK 340
A Visit to Banquet Mountains.....	JOHN W. BRYAN 341
The Capture of a Boss Trout.....	DON CAMERON 343
Song of the Angler. Poem.....	BENSON B. MOORE 344
Bushed.....	T. J. CUNNINGHAM 345
The Great Trout. Poem.....	HENRY CROCKER 349
The Hunter's Duel.....	STANLEY MAYHALL 352
Alpine Animals in Colorado.....	W. H. NELSON 355
A Coconina Squaw.....	ALICE R. CRAFE 357
Camping at Indian Lake.....	THOMAS A. BENNETT 358
A Hunt in the Big Hole.....	CLARENCE JAY 359
How to Use a Pocket Compass.....	W. L. MARBLE 361
My First Day's Work. Poem.....	ARTHUR S. PHELPS 362
An Evening Flight of Bats.....	FRONTISPIECE
Animal Life in a Cuban Cave.....	AUGUST BUSCK 397
The New Method of Fencing. Illustrated.....	F. SCHAVOIR, M.D. 401
Hard Eggs. Poem.....	GEO. A. WILLIAMS, M.D. 411
On Snubbing.....	E. J. MYERS 412
Among the Islands of Georgian Bay. Illustrated.....	MAY BRAGDON 413
I Go A-fishing. Poem.....	R. S. STRINGFELLOW 419
Pranks of Porcupines.....	G. O. SHIELDS 420
An Apostrophe to My Canoe. Poem.....	R. R. KIRK 422
On Top of California.....	D. M. LADD 423
Summer. Poem.....	WILLIAM R. BERRY 424
A Day on Lake Owen.....	C. C. HAKSINS 425
The Monarch of the Pool.....	F. H. ROCKWELL 450
From the Game Fileds. .45, 127, 210, 289, 363, 427	Forestry.....67, 151, 236, 312, 443
Fish and Fishing.....50, 133, 217, 293, 369, 432	Pure and Impure Foods..69, 154, 239, 314, 385, 446
Guns and Ammunition..54, 137, 221, 297, 373, 436	Editor's Corner.....73, 160, 244, 318, 388, 448
Natural History.....61, 143, 229, 303, 378, 439	Amateur Photography..80, 166, 250, 234, 392, 458
The League of American Sportsmen,	Publisher's Notes.....71, 157, 242, 316, 387
63, 147, 232, 307, 442	

3 1904
VOLUME 17
NUMBER 1

JANUARY, 1904

\$1.00 A YEAR
10c. A COPY

RECREATION

THE MILLER CASE; Study, Illustrated.

OFFICIAL ORGAN OF THE LEAGUE OF AMERICAN SPORTSMEN



AMATEUR PHOTO BY R. ENGELMANN.

THE SKATER.

Winner of 11th Prize in RECREATION'S 8th Annual Photo Competition.

PUBLISHED BY G. O. SHIELDS (COQUINA)
23 WEST 24TH ST., NEW YORK

The Passing of Le Premier;

A Thrilling Story of the Canadian Wilderness, by CHAS. H. SAWYER, with full page drawing by W. H. LAWRENCE

RECREATION

Copyright, December, 1903, by G. O. Shields

A Monthly Magazine Devoted to Everything the Name Implies

\$1.00 A YEAR.
10 CENTS A COPY.

G. O. SHIELDS (COQUINA),
Editor and Manager.

23 WEST 24TH STREET,
NEW YORK

CONTENTS OF THIS NUMBER

	PAGE.
"Voila! de Track".....	FRONTISPIECE
The Passing of Le Premier. Illustrated.....	CHARLES H. SAWYER 3
Juno, the Retriever.....	JAMES L. LANCASTER 7
Lines to the Hound. Poem.....	STACY E. BAKER 8
Ben's Russian Cousin. Illustrated.....	BARON PAUL TCHERKASSOV 9
Luck to the Hunter. Poem.....	MAUD M. HUEY 11
A New Star in the Art World. Illustrated.....	JOHN M. LEAHY 13
A Bear When a Buck Was Due. Illustrated.....	DR. C. N. BALLARD 15
Old Bill Gray's Story. Poem.....	JAMES B. ADAMS 16
Bounce, the Undertaker. Illustrated.....	MRS. LILLIE PLEAS 17
The Cowboy's Song. Poem.....	C. T. L. 18
One of Those Flowing Bowles. Illustrated.....	H. P. GILLETTE 19
By the Hardest.....	AMOS GRAYSON 21
Kit, the Tale of a Mule. Illustrated.....	FRANK S. ELLSWORTH 23
A Deer Accident.....	B. BOULDER 25
The 1903 Register. Poem.....	DR. J. S. KENNEDY 26
Antoine's Caribou.....	E. W. PARKER 27
Men of the Sun and Rain. Poem.....	R. B. NATTRASS 27
Mountain Badger. Illustrated.....	ALLAN BROOKS 28
Hiking in Rizal.....	CHAS. H. STONE 29
The New Army Rifle. Illustrated.....	31
Our and Somebody's Else Buck.....	FALCON 33
RECREATION. Poem.....	NED NATE 35
Bud Moose Bugged.....	H. B. BROWN 36
The Owlet's Flight. Poem.....	S. H. M. 39
A Sharp Foreboding.....	C. H. FURLONG 40
A Day in the Rockies.....	BRUCE LEMMON 42
Adventure with a Coyote.....	HOWARD CARL 44
From the Game Fields.....	45
Fish and Fishing.....	50
Guns and Ammunition.....	54
Natural History.....	61
The League of American Sportsmen.....	63
Forestry.....	67
Pure and Impure Foods.....	69
Publisher's Notes.....	71
Editor's Corner.....	73
Amateur Photography.....	80

Entered as Second-Class Matter at New York Post Office, Oct. 17, 1894.



TIDINESS

and COMFORT
for all men by using

WASHBURNE'S

Cuff Holders

Instantly Attached or Detached.

Sent Prepaid for 20 Cents.

Scarf Holder 10 Cents.

Key Ring and Chain 25 Cents.

They never come loose—a tiny lever with a bulldog grip.

Illustrated Catalogue of others on request.

AMERICAN RING CO., Dept. 44, Waterbury, Conn

Skin Diseases

If you suffer from Eczema,
Salt Rheum, Ringworm, Itch,
Acne, or other skin troubles,

Hydrozone

will cure you.

As these diseases are caused by parasites, killing them without causing injury to the healthy tissue cures the trouble.

It has cured many cases pronounced incurable and is absolutely safe.

Hydrozone is a scientific Germicide. Used and endorsed by leading physicians. It is absolutely harmless yet a most powerful healing agent.

Trial bottle at your druggist or by mail on receipt of 25 cents. None genuine without my signature on label.

Prof. Charles Harchand

F-59 Prince St., New York.

Free—Valuable Booklet on How to Treat Diseases.

Camping Out

. Camping may be pleasant, or disagreeable or dangerous. The equipment has much to do with it. Expense may be large and results unsatisfactory, or small with good results. The "KNOW-HOW"—what to take, what to leave—has most to do in insuring the comfort, pleasure and safety of an outing expedition, be it to explore untraveled mountains, or to find the north pole, or just to spend a month in the woods.

Our business is to "KNOW-HOW." Our success leads us to believe that we have learned our business.

We manufacture and sell everything for outfitting camping parties. Let us send our Catalogue R, or better still, call on us, if you contemplate "smelling burning wood" before an open tent in the shadow of the woods.

ABERCROMBIE & FITCH

314-316 Broadway, New York



"A large observation parlor, handsomely furnished."

California

The Observation Parlor on **The California Limited** is a delightful place in which to read the latest story, write letters home, or view the passing landscape. A library of books describing Western life; current magazines, too, and daily papers. Electric fans and electric lights; the chairs have that restful look. Ladies will enjoy these travel comforts.

The California Limited runs daily between Chicago, Los Angeles, San Diego and San Francisco. Less than three days to southern California. See **Grand Canyon of Arizona** en route—a mile deep, miles wide and rainbow-tinted.

Our illustrated booklets, mailed free, will help you rightly plan a California tour. Address General Passenger Office, Atchison, Topeka & Santa Fe Railway, Chicago.



ALL THE WAY

The SOUTHERN'S Palm Limited

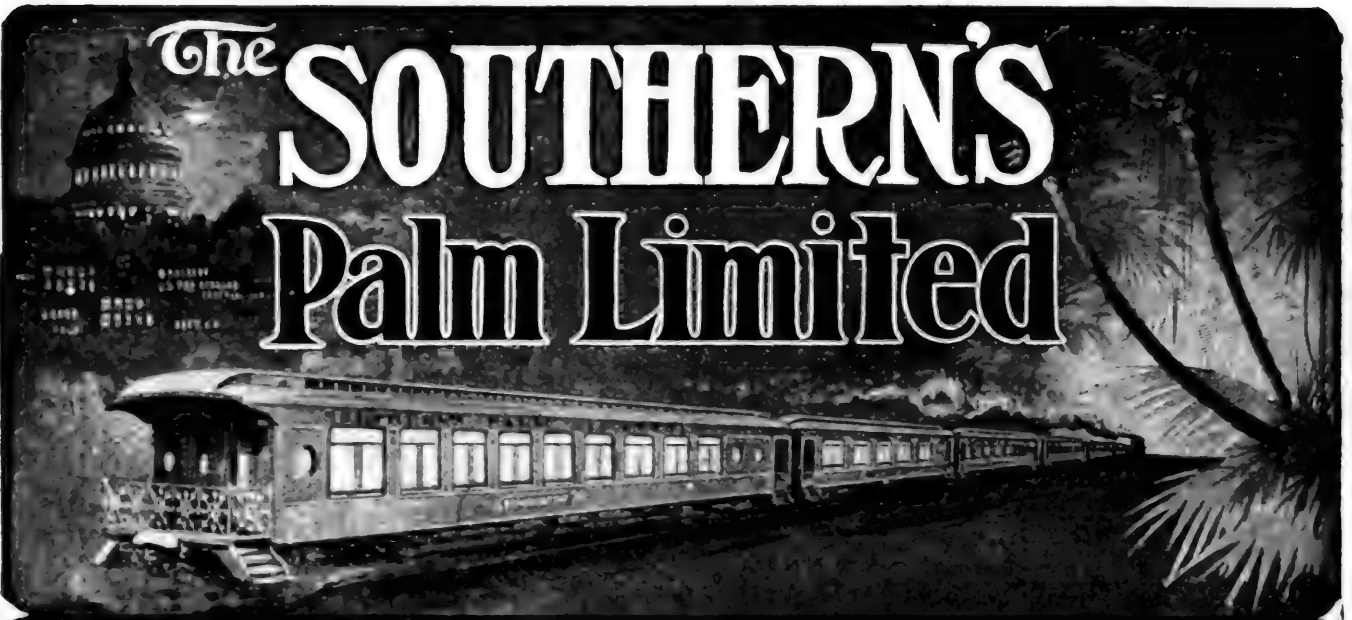

A NEW YEAR'S ANNOUNCEMENT!

January 11,
1904

Is the date of the Inauguration of "The Southern's Palm Limited" Solid Train **New York and St. Augustine**

Pullman Compartment and Drawing and State-room Sleeping Cars: Dining, Club, Library and Observation Cars. Also carrying Pullman Drawing-room and State-room Sleeping Cars New York to Aiken and Augusta.

(PENNSYLVANIA RAILROAD, NEW YORK TO WASHINGTON,
SOUTHERN RAILWAY, WASHINGTON TO JACKSONVILLE, FLA.
(FLORIDA EAST COAST RAILWAY, JACKSONVILLE TO ST. AUGUSTINE.

Leave New York Daily except Sunday, 12:40 Noon

Two other fast trains daily between the East and Florida, via Southern Railway.

New York Offices, 271 and 1185 Broadway.
ALEX. S. THWEATT, Eastern Passenger Agent.

W. A. TURK, Passenger Traffic Manager.
S. H. HARDWICK, General Passenger Agent.

DELIGHTFUL WATER TRIPS
via PALATIAL STEAMSHIPS of the

CLYDE LINE

THE ONLY DIRECT ALL
WATER ROUTE FROM
BOSTON AND NEW YORK
TO CHARLESTON S.C.
AND JACKSONVILLE
FLORIDA
WITHOUT CHANGE

THEO. G. EGER, G.M.
WM. P. CLYDE AND CO.,
GENERAL AGENTS
19 STATE ST. N.Y.



JAMAICA



JAMAICA, the most beautiful of the Caribbean Islands, is but five days from Boston and four from Philadelphia. Its winter climate is delightfully mild and agreeable. The vegetation is of rare luxuriance and gorgeous coloring. The scenery among the Blue Mountains is grand in the extreme. The hotels are excellent, the roads perfection, and the sea bathing in winter a luxury unknown elsewhere. **Can you imagine a more delightful spot for a winter sojourn?**

The United Fruit Company's

Steel Twin-Screw U. S. Mail Steamships

ADMIRAL DEWEY **ADMIRAL SCHLEY**
ADMIRAL SAMPSON **ADMIRAL FARRAGUT**

make weekly sailings between Boston, Philadelphia and Jamaica, affording a pleasant coastwise passage through tropic seas and genial temperatures. **FARE**, including meals and stateroom accommodations, \$40; round trip, \$75.

Send for illustrated booklet fully describing Jamaica, its scenery, people and interesting inland tours. Free on request.

For information and booklets address

DIVISION PASSENGER AGENT, UNITED FRUIT COMPANY

Long Wharf, BOSTON, MASS.

Pier 5, North Wharves, PHILADELPHIA, PA.

RAYMOND WHITCOMB CO., } Tourist
 THOMAS COOK & SON, } Agents
 and Leading Ticket Offices in all Large Cities.

"FOR 36 YEARS A STANDARD PIANO."

THE WING PIANO

YOU NEED THIS BOOK IF YOU INTEND TO BUY A PIANO. A book—not a catalogue—that gives you all the information possessed by experts. It makes the selection of a piano easy. If read carefully, it will make you a judge of tone, action, workmanship and finish; will tell you how to know good from bad. It describes the materials used; gives pictures of all the different parts, and tells how they should be made and put together. It is the only book of its kind ever published. It contains 116 large pages and is named **The Book of Complete Information about Pianos**. We send it free to anyone wishing to buy a piano. Write for it.

SAVE FROM \$100 TO \$200 We make the WING PIANO and sell it ourselves. It goes direct from our factory to your home. We do not employ any agents or salesmen. When you buy the WING PIANO you pay the actual cost of construction and our small wholesale profit. This profit is small because we sell thousands of pianos yearly. Most retail stores sell no more than twelve to twenty pianos yearly, and must charge from \$100 to \$200 profit on each. They can't help it.

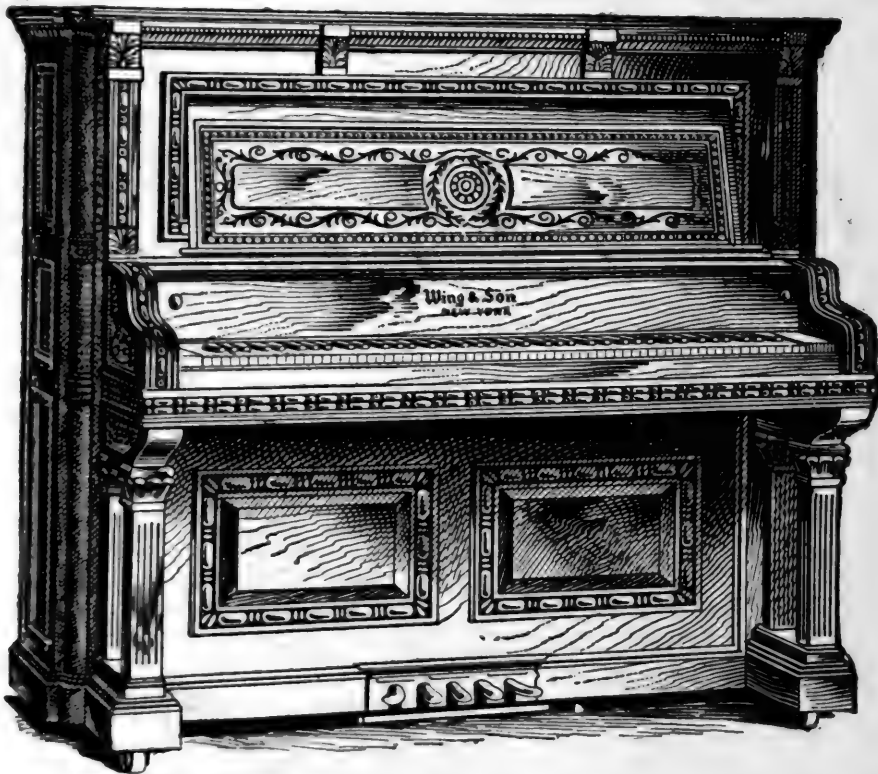

A Wing style—45 other styles to select from.

SENT ON TRIAL WE PAY FREIGHT. NO MONEY IN ADVANCE. We will send any WING PIANO to any part of the United States on trial. We pay freight in advance, and do not ask for any advance payment or deposit. If the piano is not satisfactory after twenty days' trial in your home, we take it back entirely at our expense. You pay us nothing unless you keep the piano. There is absolutely no risk or expense to you.

Old instruments taken in exchange. **EASY MONTHLY PAYMENTS.**

INSTRUMENTAL ATTACHMENT A special feature of the Wing Piano; it imitates perfectly the tones of the mandolin, guitar, harp, zither and banjo.

IN 34 YEARS, 33,000 PIANOS We refer to over 33,000 satisfied purchasers in every part of the United States. WING PIANOS are guaranteed for twelve years against any defect in tone, action, workmanship or material.

WING ORGANS Are just as carefully made as Wing Pianos. They have a sweet, powerful, lasting tone, easy action, very handsome appearance, need no tuning. Wing Organs are sold direct from the factory, sent on trial; are sold on easy monthly payments. For catalogue and prices write to

WING & SON, 350 to 356 West 13th St.,
NEW YORK.

1838 —36th Year—1904.

PINEHURST NORTH CAROLINA

(FOUNDED BY JAMES W. TUFTS)

*The HEALTHIEST and MOST
PERFECT RESORT in the SOUTH*

**Four Splendid
Hotels
Fifty Cottages**

**Two Excellent
Golf Courses**

PINEHURST is in the center of the sandy **LONG-LEAF PINE REGION** and enjoys a climate which offers a happy medium between the enervating qualities of the extreme South and the rigorous winter of the North.

THE HOTELS OF PINEHURST are all under one management and vary in rates from \$12.00 per week up. Cottages rented by the season.

THE GOLF COURSES are, by common accord, the best in the South, the annual North and South Championship Tournament being held at Pinehurst every year. Golf, shooting and tennis tournaments weekly.

25,000-ACRE SHOOTING PRESERVE. Fine livery, equipped with saddle horses, horseback riding being one of the features of Pinehurst.

PREPARATORY SCHOOL under direction of Prof. Aldice G. Warren.

PINEHURST is a private estate about ten miles square, ranking among the leading properties in the South in size and attractiveness. It has an altitude of about 1,000 feet above sea level. Among its many natural charms is the large percentage of bright, sunny days and its freedom from damp, penetrating winds.

PINEHURST is the only resort in America from which **consumptives are absolutely excluded.**

Through Pullman service. One night out from New York, Boston and Cincinnati, via Seaboard Air Line or Southern Railway.

Send for beautiful pamphlet, "Pinehurst," or "The Game at Pinehurst," or both.

Address

**PINEHURST
GENERAL
OFFICE**

*Pinehurst,
N. C.*

**LEONARD
TUFTS**

Owner

Boston, Mass.



YOUR MONEY BACK IF YOU ARE NOT SATISFIED.

DO YOU SUPPOSE that a company with a capital of \$500,000.00 paid in full, and the proud reputation of 37 years of continuous success, would make such an offer and not carry it out to the letter?

DO YOU SUPPOSE we would injure our standing with the public and our chance, of still greater success by failing to fulfil our offer?

DO YOU SUPPOSE we would make such an offer if we did not have the utmost confidence in the satisfying quality of our goods?

WE KNOW we can please you and save you money, for HAYNER WHISKEY goes direct from our own distillery to you, with all its original strength, richness and flavor, carries a UNITED STATES REGISTERED DISTILLER'S GUARANTEE of PURITY and AGE and saves you the big profits of the dealers. That's why it's best for medicinal purposes and preferred for other uses. That's why we are regularly supplying half a million satisfied customers. That's why YOU should try it. Your money back if you're not satisfied.

HAYNER WHISKEY

4 FULL QUARTS \$3.20

EXPRESS CHARGES PAID BY US.

We will send you **FOUR FULL QUARTS** of HAYNER SEVEN-YEAR-OLD RYE for \$3.20, and we will pay the express charges. When you receive the whiskey, try it and then if you don't find it all right and as good as you ever drank or can buy from anybody else at any price, you may send it back at our expense and your \$3.20 will be returned to you by next mail. How could an offer be fairer? We stand all the expense, if the goods do not please you. Won't you let send you a trial order? We ship in a plain sealed case; no marks or brands to even suggest contents.

Orders for Ariz., Cal., Col., Idaho, Mont., Nev., N. Mex., Ore., Utah, Wash., or Wyo., must be on the basis of 4 Quarts for \$4.00 by Express Prepaid or 20 Quarts for \$16.00 by Freight Prepaid.

ESTABLISHED
1866.

THE HAYNER DISTILLING COMPANY,

DISTILLERY,
TROY, OHIO.

DAYTON, OHIO.

ST. LOUIS, MO.

ST. PAUL, MINN.

ATLANTA, GA.



THE UNIVERSITY OF CHICAGO LIBRARY

100 EAST SOUTH EAST AVENUE CHICAGO ILLINOIS 60607

TEL: 773-936-3700 FAX: 773-936-3701

WWW.CHICAGO.LIBRARY.EDU

CHICAGO LIBRARY

CHICAGO LIBRARY

CHICAGO LIBRARY

CHICAGO LIBRARY

CHICAGO LIBRARY

CHICAGO LIBRARY

CHICAGO LIBRARY

was measured off, and it did snow before night; a gentle, sifting fall that made good tracking. It ceased snowing after sundown, and camp was made. Next morning all impedimenta were stowed in a hastily constructed *cache*, and progress was resumed in light marching order. The log of the second day may be written with one word; tramp. It was dryly monotonous. Tired? That Indian, Gros Jean, could keep up a steady push for 2 days beyond forever, and then some. Through thickets, over rocks and adverse tangles of logs, tearing through heart-breaking masses of jagged dead limbs and biting briars in the brule; up precipitous boulders, clinging to roots and jutting crags I toiled, until bailed out of both ambition and wind. No man ever got a moose who did not earn him.

How far did we go? Gros Jean said 15 miles. I should guess something less than 500. What does an Indian, whose tendons are steel ribbons, and who pumps wind with gutta percha bellows, know of miles? He measures distance by time, anyway. So, when old Sol was half way down the home stretch, that is, about 3 *post meridian*, we struck the fresh trail of 8 moose, the tracks showing one giant.

"Regard you, *le premier!*" said Gros Jean. "Ah'll lak for see de horn of de an-mal dat mak dat beeg fit."

Moose tracks have been seen that would compare favorably with a New England pancake, but these looked bigger than a full moon through a September haze.

"*Arrete donc,*" said the Indian. We stopped, and there, under the snow-laden branches of a giant fir, browsed a cow moose, broadside on, not 30 yards away. We stood. The cow stood. Did I shoot? "I gass not, yes, I gass not," as my Franco-Indian would say. There were no horns on that head, and we were not out for meat. Besides, my permit said only one more moose. She slowly made off, and, not long after, the spoor of

the "premier" separated from the others, trailing through a ravine. We followed in a circling course a while, when the guide stopped, and, pointing at the dipping sun, "De moose will soon mak' lie down for de sleep," he said. "Soon com' dark. What you goin' do about? Camp in snow wit'out blanket? No? *Bon!* We go back. She's only 6 mile straight. To-morrow on de morn we tak' h'up dis-a-track an' fin' bull."

That back pedal trip to the base of supplies was nerve wrenching. The advance and retrograde movements of that day reminded me of a bit of ancient literature anent the King of France, who, on an occasion, marched up a certain hill to do dire things, only to about face on the summit and march down again. Supperless I tumbled into blankets under a rude brush shack and slept the dreamless sleep of overtaxed muscles, when a guttural voice and heavy hand shocked me into conscious being.

"Mos' come day; we go for de moose," said the voice.

"D——n the moose!"

But only for a moment did tired nature revolt. Hope and ambition, twin spurs to all great deeds, returned with a copious draught of skitty-waugh-boo (Injun for rum), a smart rubbing of the face with snow, and a hastily prepared snack. It was as murky as a smoke house, and I would have made for the North pole or any unmapped locality but for the guide. Following him automatically I lurched along until, just as the dawn with faint pink splashes began to blush in the East, we came on the hoof tracks at the point where the premier had separated from the rest of the herd the previous day. The halfbreed, who had not fired a linguistic shot for nearly 3 hours, then delivered himself:

"Now we leave de moos' mark. We go dis-a-way," waving his hand in a different direction. "We shall fin' heem or de track jus' all de sam', but we save seex t'ree mile, mebbe."

This is the proper time and place to kowtow to the woodcraft, or moosecraft, of the humble ranger and guide. How did he know that, by leaving the broad trail and striking off into the untracked snow, he would again meet either the clearly marked course or the animal itself, and thus save a long, stern chase? His own answer is best. It was his "bizi-ness." A man brought up with bear, deer, moose and the like, keeps tab on their habits and doings. While resting a moment on a stump, pumping oxygen for that last final dash, between gutturals and shattered *habitant* talk, Gros Jean said things from which the following deductions were made:

A moose often travels all day in a more or less devious course, but as night draws on, it circles around until it comes back near its old track, at which point it lies down for its night's rest. In other words, it makes a sort of loop at the end of this line, to finish its day's journey. It is thus in a position, while resting, to see, hear or smell any person or animal following its spoor, and at the slightest hint of danger it is off. The Indian, calculating the time of day, knew about when the beast would begin to loop; but he followed the turn in the course far enough to estimate the size of the loop made by the bull, judging the whole circle by the arc traveled, so that, from the point where we stood, he could approximately calculate the direction and distance to be pursued in a straight line before striking either the track of the moose or its actual resting place. Nature taught, and unskilled in mathematical lore, for he did not know a segment from a squash, and never heard of geometric arcs or subtending chords, yet following events proved the guide's roughly formulated hypothesis to have been correct.

Cautiously we made our progress in the untrodden snow. The ranger advanced noiselessly, with neither the snapping of a dead twig nor the

swishing of a limb. Imitating him, I also moved with caution, making noise enough, it seemed to one with nerves as tense as fiddle strings, to arouse the 7 sleepers had they been in the berth of the beast we were after.

"*Gardez vous,*" at length muttered the savage, lapsing into Kanuck lingo. "*Voila! De track.*"

It was true. We had hit the trail.

"Walk on de holes mak' by de bull fit so de snow not mak' crack an' scare de game. She mus' be ver' close, mebbe!"

For 300 or more yards the advance was made slowly, cautiously, painfully. Suddenly Gros Jean clutched my arm.

"Le premier!" he whispered, stabbing the atmosphere in front with grimy forefinger.

I looked. On the crest of a ridge, at least 400 yards away, lay the moose. Slowly lifting his mighty head, as if conscious that his habitat had been invaded by desecrating aliens, although the wind was coming from him, he sniffed the air with whistling nostrils as he ponderously rose to his feet. Ye gods, what a shape! And antlers! They looked like the spread of a full rigged ship.

I choked off a nervous gasp and took sight.

"Wait! Mak' near yet," breathed the guide.

We closed the gap perhaps 150 yards, still stepping in the hoof marks and crouching behind low, bushy cedars. The monarch swung his mammoth head in our direction, and leaned as though to lurch forward.

"Now," whispered Gros Jean. "Goin' ronne, mebbe."

The crisis had come. All hardship, waiting and toil had led up to this crucial moment. I fired as steadily as I could, aiming behind the left shoulder. Thunder! I missed. I had not properly calculated the range. Quick as a lightning stroke the big ears flashed forward, the prehensile

muzzle violently twitched, and the great creature, instinct with wild, brute curiosity and terror, looked like some huge, misshapen monster left over from a prehistoric era. The pause was fatal. I knew I could not afford to wait. Whang! spoke the rifle again, with not 2 seconds' interval between the reports. This time the moose made a wild leap into the air, and vanished down the rocks.

"Bon!" shouted Gros Jean, "Ah'll gas you hit heem!"

At last Gros Jean was excited. The emotional French strain in him for the time being dominated the stoicism of the savage. He leaped forward, I following, an excited second. Taking a header over a stump, I was busy a moment, when I heard a war whoop, and,

"Dis-a-way, M'sieu!"

Then I saw my prize. He sat on his haunches, a ragged hole, from which pulsed the life blood, ripped in his side. His long, sinewy forelegs were spread wide apart, supporting the massive shoulders and ugly, antlered head, which hung pendulously low. With expiring strength he floundered to his feet, only to fall again. He groaned in mortal agony, and, perhaps, who knows? with the shame of being conquered. Then the madness of death came on him; its glazing film dimmed the glory of his

fiery eyes. The forest homestead, its green trees, its cliffs, its deep ravines and mossy glades, were fading, fading. The heavy nostrils, flecked with bloody foam, quivered in a last spasm of pain, and he fell. His rule throughout that vast primeval domain was ended, for the lordly beast was dead.

How big was he? Oh, that's a guess; but Gros Jean, who is a good Yankee in some things, puts the weight at 1,200. The horns, however, measure exactly 63 inches from tip to tip and carry 33 points. The web is 16½ inches wide. In the ordinarily large bull the palmated breadth is about 8 inches. Am I right, Gros Jean?

"Au-haugh. Dat moose her so beeg lak you did say. Lucky t'ing we did raf' her down de Maganasipi rivière to dis place, so de camp do see heem; but some oder bod-dee, perhap, not beleve you did git soche beeg feller."

"Perhaps not," was the answer. "But as you once pointedly remarked, my friend, 'n-importe.' That makes little weight with one whose soul is conscious of rectitude. Skepticism is the homage which envy pays to success. That majestic shape hangs on yonder tree to refute the baseless charge of skeptics that its magnificent proportions were conjured up in imagination. *N'est ce pas, Gros Jean?*"

"Au-haugh," said the guide.



AMATEUR PHOTO BY C. C. SPEIGHT

NIGHT HAWK.

One of the 20th Prize Winners in RECREATION'S 7th Annual Photo Competition.

JUNO, THE RETRIEVER.

JAMES L. LANCASTER.

Before leaving here last November for my usual Autumn visit to my plantations in Virginia, I had given orders to my manager to put Juno, my 3 year old retriever, in the hands of her trainer, so she might have some field work before I should arrive. Recollecting her past history I expected great things of her.

The morning after my arrival the trainer and I mounted our horses, taking with us on another horse a boy to carry extra shells and luncheon, and any game we might be fortunate enough to kill.

I found quail abundant, more so than for several years past. Juno was perfectly aware of the duty expected of her and anxious to perform it. She ranged well in front of the horses, moving rapidly and covering the ground thoroughly. I soon ascertained that she is careful and staunch, and is a first class retriever. She never failed to find and fetch the dead bird promptly, and it was useless to insist on "dead bird," for if she did not get it and bring it in at once there was no dead bird to be brought.

During the first day's hunt, and a little before noon, a covey of quails flushed wild and flew into a sedge field containing a few scattered pine trees. It was a good place to shoot single birds, as they lie close in the sedge, and the pines interfere but little. We followed, and after good work by Juno and fair success on our part, she pointed again. That time the bird flew to the left and was shot by the trainer.

At the word the dog bounded forward, picked up the bird and was returning when, with the quail in her mouth, she once more came suddenly to a stand. She held the point steadily while we gazed at her in admiration. Then, feeling that it was not fair to the dog to hold her longer on point, we closed in, and I kicked the bird out of the sedge.

Both of us fired and the bird fell, seeing which Juno bounded forward and, still holding the first bird in her mouth, made desperate efforts to pick up the second. Failing in that, she left it where it lay, brought in the bird she already had, then went back and fetched the other. A few minutes later, when at lunch, we gladly shared the best we had with Juno.

I have been in the field almost every fall for the past 20 years, but until then had only once seen a dog stand a live bird while holding a dead one in his mouth. That was when I was a boy. I afterward described the scene to an old man who did

not know much about dogs, especially pointers. He listened, smiled, and then said:

"I have always heard that if you want to make a first class liar of a boy you have only to give him a gun and a p'inter."

For a long time afterward I was shy of telling about that incident.

I do not now think it worth while to explain this statement to sportsmen; but as some people, not sportsmen, who read your magazine, might be inclined to agree with the old man, I add this explanation:

The pointer's nose is trained to the scent of the live bird. This the bird will lose, in cold weather, in a few seconds after death; so the dead bird in the dog's mouth does not prevent him from smelling the live one. It may confuse the scent somewhat and render it less emphatic, but does not make it indistinguishable, especially at close range.

A dog with the best of noses often has difficulty in finding a dead bird. He will run over it again and again, finding it only by the closest search and then frequently by sight.

There are certain disadvantages in allowing a dog to flush birds, which overbalance any advantage gained by permitting him to do so. A dog that is allowed to flush can never be a good retriever. In the act of flushing birds, the dog's attention is engrossed with that alone, and he loses sight of or fails to notice the falling bird. This often means a long search for dog and hunter, in order to find the bird; while if the hunter flushes, the dog soon learns to watch for the bird, and has little or no trouble in finding it. The dog should see the bird when hit and while falling, if he is to do his best work as a retriever.

I saw Juno on one occasion bringing in a dead bird when another bird got up and was killed. She saw this bird fall, and instantly dropping the bird she had in her mouth, knowing, I believe, that she could easily find it again, rushed off to get the bird she had marked down. When she had brought that one in, she went back and promptly fetched the other.

A good retriever usually marks the falling bird, knowing that if the eye be taken off the spot there may be much trouble in finding it. Good sight, added to keen scent, makes a good retriever.

I would count a retriever of little value if I had to spot the falling bird and then show the dog where it fell, only to see him pick it up and bring it to me. The value

of a retriever lies in its ability to do all this without assistance, and therein Juno excels.

The dog should stand to a flush and not break to shot; neither should he go for-

ward until told to do so. But no "down charge!" while you flush the birds. Your dog must stand and watch them as they rise, so that he may find and retrieve the dead bird promptly.



AMATEUR PHOTO BY WM. R. MAGEE.

DUKE, POINTING.

Winner of 33d Prize in RECREATION'S 7th Annual Photo Competition.

LINES TO THE HOUND.

STACY E. BAKER.

Sad eyed, he sits and dreams of days gone by,

And wonders if he's lost that subtle knack,
That made him in his youthful master's eye

The pride and praised of all that famous pack.

The hounds! The hounds! Mad with the race!

And hunter, too, on fleet foot horse!
The chase! The chase! All join the chase!
The fleeting red fox names the course.

Don's hunting days, alack, have long since passed;

He of the pack is left alone. 'Tis morn,
He stretches stiffened limbs, his breath comes fast;

He trembles as he hears the hunter's horn.

The death! The death! With live blood flush,

Survivals of this reckless chase!
The brush! The brush! Who gets the brush!

Who, who, but she who set the pace.

BEN'S RUSSIAN COUSIN.

BARON PAUL TCHERKASSOV.

Photo by the Author.

Herewith I send you a photograph of Forester Yakhimóvitch and his bear cub, as a pendant to Ben's likenesses, adorning the July issue of RECREATION. Yakhimóvitch's cub rejoiced in the name of Mishka, Mikey, as male bears generally are styled, the female ones being usually called Máshka, Molly. Mishka is represented begging for sugar, for which he had a weakness. He had the run of the house and of all the premises in Bobróvka, District of Altaï, Western Siberia. It was rare fun to see him, during meals, rear up on his hind legs and beg for something to eat, emphasizing his begging attitudes with a droll kind of mumbling, his little, yellowish eyes glistening like sparks. What his subsequent fate may have been, I do not know, but am afraid it has been sad, like that of almost all bear cubs kept in captivity, of which I have heard, or which have come under my personal observation.

Some 6 or 7 years ago a country neighbor presented a bear cub to my children in my absence. I should have declined the present, on the strength of my unsatisfactory experience with cubs of wild beasts kept as pets; but as my family spend the summer and autumn on our estate in the Province of Yaroslav, while my sojourn rarely exceeds one month, I did not know anything about this addition to the family circle until I went for my holiday.

One evening in July I reached home, after a drive of 45 or 50 miles over most disgusting roads, thoroughly broken up, having had to make the journey in a rough and primitive vehicle, besides being in poor health. It is only fair to say that things have greatly improved since then; 12 or 13 miles to the nearest railway station, roads fair and health ditto. Not feeling up to much after my journey, I took my evening meal with the family, and went to bed early, enjoying the prospect of a good night's rest. In this I was, however, disappointed. My sleep is always light, especially the first few nights after a radical change of surroundings. Soon after dawn, that is, about 4 a. m., it was broken by a short, bleating sound near the house. I sat up in bed, annoyed by this disturbance and unable to account for it, as I knew there were no sheep on the estate. From that time on I got no rest, those confounded bleatings making sleep impossible and ceasing only toward 7 a. m. When my wife awoke and inquired how I had slept, I unfolded my tale of woe.

"Oh, it must have been Mishka, calling for food!" she said.

"Who is Mishka?" I asked.

"Such a dear little bear cub! Mr. A. presented him to the children."

I am fond of animals and of infants of all kinds in particular, but I mentally consigned Mishka to a certain warm place, and Mr. A. too.

However, I made Mishka's acquaintance, and we soon became good friends. He was a "nat-rally kangaroo cuss," like Artemus Ward's kangaroo, and we got no end of fun out of him. It was not always unal-



THE FORESTER AND MISHKA.

loyed fun, though. Once he managed to pull his collar over his ears, and go on a reconnoitring tour. He got into the room of one of the maid servants, opened her chest of drawers, pulled out all her dresses and spread them out on the floor. Then some jars of preserves attracted his attention. He cleared them in a short time, getting the whole of his muzzle sticky, as well as his paws. He started cleaning them on the unfortunate dresses spread out on the floor, and there is no saying where his mischief would have ended, if the girl

had not come in at that moment. There was a scrimmage, howls, tears, swears, etc.

Another time, Mishka broke loose with his chain, under laughable circumstances. One of the carriage horses had escaped from the stables, and was cantering along the road, quite forgetful of Mishka's whereabouts. Mishka was enjoying his afternoon nap, from which the sound of the horse's hoofs roused him rather suddenly. He reared up and emitted the peculiar hissing, or spitting, sound, which bears, at least young ones, utter when scared. The horse was at that moment emerging from behind a bush in the bend of the road. The sound of Mishka's hissing, and the sight of his chubby body standing erect with outstretched paws, was too much for the horse. It gave a terrified snort and started back for the stables as if it were chased by a pack of wolves. Mishka's digestive apparatus could not stand the shock. We call this kind of sudden indigestion "a bear's fit" or "a bear's attack." Neither could the peg to which the end of the chain was fastened stand the sudden wrench Mishka gave it, and off went the whole show like a streak of lightning. Up the trunk of a tall willow Mishka tore along, leaving unpleasant tracks behind, till he reached the upper fork of the tree, where he took a rest and tried to compose himself. The whole affair had taken place under my eyes, and it was so utterly and irresistibly funny that I nearly burst my sides laughing. My wife hearing me roar with laughter, came out, and together we tried to persuade Mishka to come down. After considerable coaxing, he began his descent; but that proved by far the more difficult part of the performance. He had not descended more than a few yards, when the end ring of the chain caught in a fork. Mishka was annoyed at this, and began to pull for all he was worth, with the result that he lost his footing and swung out into space, some 75 or 80 feet above the ground! Luckily, he managed to grasp a small bough which gave him a temporary support, but it was evident this would not last long. It began giving way under his weight, almost as soon as he got hold of it. You can imagine we did not enjoy the situation! Fortunately the boy who looked after Mishka happened to come along just then. He manfully ascended the tree, dodging Mishka's tracks, and rescued him from death.

Some days after this incident, this same boy John, noticing that Mishka enjoyed sucking his fingers, hit on the brilliant idea of giving him the tip of his tongue to suck. At first it tickled John, then it began to hurt. He tried to rescue his tongue, but

Mishka did not approve of it, and a scrimmage ensued, in which John was sorely handicapped. He set up a howl that brought us all to the scene of action, where we found Mishka firmly fixed to John's tongue. It took some manœuvring to separate them, and poor John had a sore time of it for 2 or 3 days. His tongue was swollen to such an extent that he was unable to stow it away comfortably in its proper place!

In October, when my family were about to return to town, Mishka was sent back to Mr. A. He spent the winter there quietly, but in the spring he began his tricks. Being allowed to roam about the premises, he began to appropriate articles of food which were not intended for him. One day the housekeeper caught him in the act of diving under the table with a choice melon to which he had helped himself while there was no one in the dining room. The result was a sound whipping for Mishka.

Some days later, the housekeeper was walking in the orchard, when a big apple hit her hard on the right eye. The language she used was, I am told, forcible, flowery and to the point, when she discovered Mishka sitting in a large apple tree, from which he had hurled the apple at her, with a wicked grin on his ursine mug.

After that performance, followed by several others of a similar character, it was deemed best to lock Mishka up, and a roomy compartment was allotted him in the stables. At first there was some uneasiness among the horses, but they soon became accustomed to their new companion, and all went well for a while. Then something went wrong with the horses. They would suddenly start kicking, and plunging, and snorting, several times a day, as if something had scared them; but when the stable boy went to see what was the matter he never found anything suspicious. Mishka was in bed, looking so sweetly innocent that it would have been a shame to suspect him of having caused the commotion. One day, however, the groom noticed that the tails of some of the horses were looking thin. He suspected Mishka, and eventually caught him in the act of pulling the hairs out of the horses' tails!

After this discovery Mishka was kept chained, and his temper grew rapidly worse, until finally he had to be killed before he attained the age of 3 years.

I am afraid that such is the fate of fully 75 per cent of the bear cubs kept by private parties, and that is why I always energetically protest against any attempts to make pets of them. Ben, Baby Sylvester, our Mishka, are a small percentage only of the number of cubs that have been petted and

cared for through a more or less prolonged period, but have had to be disposed of or killed in the end.

I am not sure, now, whether it was not a performance of our lamented Mishka, while living at Mr. A's, to teach turkeys swimming; and when the stupid things

would not learn to swim, and scrambled out of the water on to the bank, clamoring their "Bother-other-otheration," to twist their necks for them, and to lay them out on the bank with a view to artistic effect. If not his doing, it was the trick of a cub I have been told about.

LUCK TO THE HUNTER.

MAUDE M. HUEY.

A glorious morning, glittering jewels
On blade and vine,
Frost-drawn scents from spruce and cedar
Hemlock and pine.
Wind of the hillsides fanning to fullness
The hunter's breath;
Snow enough to further his purpose
Soft on the heath.
Sapphire skies, and a sun of splendor
Over the wood.
Morn of wonder! Ah! but the all wise
God is good.

Hark! A sound in the dead twigs yonder,
A timid stir.
Luck to the hunter! See! In the bushes
A bunch of fur.
A hare! Ah! Steady! The hounds are
after!
Be ready to fire!

Wildly plunging, their red jaws dripping
With their desire.
Will they find him? Crouching close to a
boulder
With beating heart?
A quivering thing with wild eyes bulging
And ears apart.

Yes! They are close! Ah! Now make
ready!
Away! Away!
Following, following; faster, faster,
A streak of gray.
Do they have him? No. A moment only,
A flash, a sound,
And a helpless form lies bleeding, quiv-
ering,
Flat on the ground.
Eyes all glazed with the pain of dying
Turned on the wood.
Luck to the hunter! Ah! but the all wise
God is good.



AMATEUR PHOTO BY C. B. CHAPIN

MISS MARY CONANT, ON LADY LOU; RECREATION AND SPORT FOLLOWING.



AN UNEXPECTED MEETING.



INDIANS OF THE NORTHWEST COAST.

A NEW STAR IN THE ART WORLD.

JOHN M. LEAHY.

Under separate cover I have sent you 4 of my original drawings, which are the greatest pieces of art that have ever been produced. One glance at these masterpieces and you will forget that there are such men as Frederic Remington and Dana Gibson.

First turn to "A Young Klondyker." This drawing represents Kit Carson, the famous scout and miner, when a boy. Notice the artistic touch to this picture. Also how firmly Kit has braced himself and how in-



A YOUNG KLONDYKER.

dustriously he is trying to dig himself out. When this drawing appears in RECREATION subscriptions will come in by the carload.

Next comes "Hostiles." This drawing represents Daniel Boone, General Crook's famous scout, running across 2 Apaches. How Boone followed and scalped them is well known to every reader of frontier history. Notice the artistic curve in the horse's tail.

Next comes "Indians of the Northwest Coast." This drawing shows 2 Comanches, or Delawares, I do not know which, in their war canoe. Something has evidently attracted their notice; but again I am at a loss, for I can not tell why they are looking in the direction in which their eyes are turned.

We will now take leave of the 2 Delawares or Comanches, and pass on to "An Unexpected Meeting." This drawing represents Israel Putnam's meeting with the advance guard of the British Hussars before he plunged down the declivity at Horseneck. The strongest point in this drawing is the thrilling manner in which

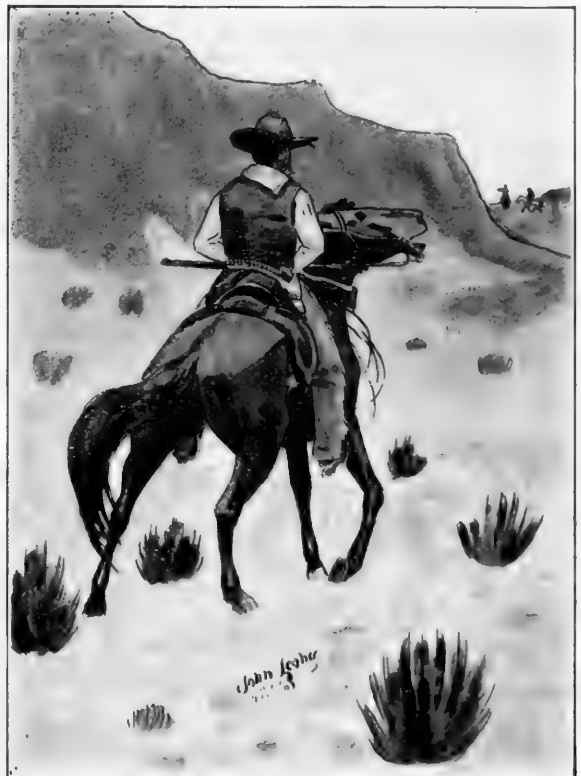

HOSTILES.

Mr. Putnam fingers his shooting iron. You can see by this that he is going to do something desperate right away.

Patient: I am afraid I haven't money enough to take this treatment, doctor.

Doctor (stiffly): Very well, sir. But if you get well without it, don't blame me.—Life.



THE ANIMAL FINALLY BURST FROM THE THICKET ALMOST ON TOP OF ME.

A BEAR WHEN A BUCK WAS DUE.

DR. C. N. BALLARD.

Last year I spent my vacation with 3 companions in the pineries of Northern Michigan. We lodged with 2 woodsmen, a father and son, who, with their wives, occupied a log cabin in a deserted lumber camp. The first part of our stay was spent in hunting grouse, which were abundant, and in catching pickerel, black bass and trout. Our bill of fare was ample and varied, and often included venison. We had fine weather, with just enough snow and rain to keep the fallen leaves moist.

The elder of our hosts devoted much time to trapping. For several days after our arrival he piloted me each morning to a place where he had a bear trap set. As he did not succeed in taking anything larger than a porcupine I finally lost interest in these morning trips, and amused myself in other ways. That there were, or had been, bears in the region was proven by a number of hides that hung about the cabin, but, as I have intimated, I lost hope of meeting Bruin in the flesh.

The end of my vacation drew near, and as I was going out before the others, a big hunt was planned for my especial benefit. It was to be a record breaker in every respect. On the eventful morning came a light fall of snow, just enough for easy tracking.

With a good lunch in our pockets 4 of us started for an all-day hunt. Just as we entered the woods up jumped a short horned buck. It was all too sudden, and in our unreadiness we shot over, under and all around him. He did not leave us even a lock of his hair.

Then we separated to drive the woods. We saw several deer and fired a number of shots without bagging any meat. After we had beaten up several miles of thick brush 2 of my companions became disgusted and took the back track, leaving the old guide and me to continue. We went on, keeping several hundred yards apart. I soon found a deer track and followed it until I was tired. Coming to a tangle of logs I sat down to rest. When I started to climb over the pile of timber a big buck jumped up not 40 feet from me. The surprise and my fatigue were too much for me, and in the act of lifting my rifle I lost my balance and fell from the log on which I was standing. When I did

get a shot it was at over 200 yards, with the buck going like the wind. He disappeared, carrying his flag high, and I knew it was not worth while to follow.

By that time I had lost my bearings completely and the guide had to give me the line of our further march by compass. I was resolved to get game of some kind, and pushed ahead, though the hills seemed steeper and the tangle thicker than ever. Soon I came to a dense growth of willows in a bit of swampy ground. I climbed a pile of logs and stood leaning against a bush that seemed willing to help support a tired hunter. It was not long until I heard a crackling in the brush, faint and distant at first, but coming nearer.

I crouched near the logs, expecting every minute to see the horns of a great buck. So sure was I of what was coming that I began speculating as to how I was to smuggle those horns to my home outside the State. The animal finally burst from the thicket almost on top of me, and I saw—not the expected horns, but 4 big black feet supporting a great black convexly curved body. A bear, and a monster, too! It was my first experience with *Ursus*, and he looked a different proposition from anything I had solved. I had been told that a wounded bear was not a desirable play-fellow and the tangle around me was no place in which to attempt to cut down the running record. I concluded, however, that the chance was too good to lose. The bear lifted his head as if scenting me, and I put a soft nosed 30-30 bullet just 2 inches behind the base of his ear.

I had heard that a badly wounded bear would at once roll on his back, with his feet up. It proved true in this case at least. Over he went, pawing the air wildly. A moment in that position; then, with a struggle and a growl, he regained his feet and made off. I fired once more, the bullet taking effect in his back. Nevertheless he went off at breakneck speed.

When the guide came up we trailed the bear. It was an easy matter, though at first there was no sign of blood. Farther along we found some, and later, great clots of it. An eighth of a mile from where he was shot we came to the dead body of my first bear.

In the spring the liar's fancy lightly
turns to thoughts of fish.—The Pilot.

OLD BILL GRAY'S STORY.

JAMES B. ADAMS.

The camp fire blazed with a merry light,
Like a gleaming gem in the breast of night,
And the group of hunters who sat around
Caused the hills and valleys to oft resound
With peals of laughter, as yarn and song
Fell glibly off from each wagging tongue.
Far up the gulch from its rocky lair
The mountain lion, with restless air,
Gazed down on the scene so weirdly
strange;

And far above in the rugged range
A night owl hooted in weird surprise
As the gleam of the fire met its owlish
eyes;

While a panther crouched in astonished
way,

All undecided to run or stay.

'Twas a picture familiar to Western eyes,
Yet strange would have seemed under
Eastern skies.

"Speakin' o' grizzlies," said old Bill Gray,

As gray of hair as he was of name,
"Speakin' o' grizzlies, I want to say
That I reckon I'd ort to know that same.

An' speakin' o' tenderfeet, I've heerd
It said they will never hold their ground,
But'll act as if summit slightly skeered

At a hint that a grizzly's nosin' 'round.
But I once was taught at a Eastern school
Thar's allus exceptions to every rule.

Mortimer King was the name 'at he

Had struck right acrost a little card,

An' when he handed the same to me

I looked at the Easterner purty hard.

A little bit of a runty chap,

With glasses sot on his squinty eyes,

An' wearin' a sort of a striped cap,

An' britches that fit him around the
thighs

Like the skin of a sassage; an' socks, I
sw'ar,

The same as I've heerd that wimmen folks
w'ar.

He war' puffin' away at a cigaroot,

An' when he said 'at he'd like to stay
With me till he'd run on a chance to shoot
A grizzly, my laughin' string give way
An' I squealed till I split my sides; but he
Never weakened a little, nor cracked a
smile,

But said he reckoned 'at I mout see

Him hold his own with the animile.

So I tuk him into my cabin, jes'

'Cause the cuss 'd amuse me, more or less.

'Twas fun fur to hear the little cuss

A leakin' language 'bout what he'd do

Ef he tuk a hand in a grizzly muss.

Why, boys, from a hunter's point o' view

'Twas too ridiculous fur belief.

But I let him talk to his heart's content,

A sort o' feelin' he'd come to grief

An' hit the trail to the rear, hell-bent

The fust time we sighted a grizzly b'ar

A trampin' around in the hills up th'ar.

To shorten my story, we started out

Nex' day, a nosin' around fur game,

An' Mortimer King jes' a blowin' 'bout

How keen he war fur to find the same.

We hadn't tramped it a mile afore

We hit a trail that w'ar mighty fresh;

It follered the gulch a ways, then bore

To a thicket o' manzanita bresh,

An' that feller's eyes begun to dance

When I tol' him that now was his golden
chance.

Afore I knowed it that little cuss

Duv into the bushes jes' like a dart,

An' in half a second I heerd a fuss

That made me chilly around the heart.

That ol' Winchester o' his give tongue

To some lively barks in a spiteful way,

An' the howls o' the wounded grizzly brung

My heart in my throat like 'twas th'ar to
stay.

By Godfrey, pardners, I jes' tuk root

To the ground; couldn't move either hand
or foot!

When I got my senses I hurried in

Expectin' to find but a chawed up dude,

Fur all had become as quiet as sin,

An' I 'maged the b'ar was enjoyin' his
food.

But th'ar stood Mortimer, punchin' at

A monster b'ar with his girlish foot,

His eyes never givin' a skeery bat

As he puffed away at a cigaroot;

An' I jes' collapsed when I heerd him say,

"How much will the bloody critter weigh?"

BOUNCE, THE UNDERTAKER.

. MRS. LILLIE PLEAS.

Having just returned home after a few days' absence, I was awakened from a restful nap by sounds which had hitherto been foreign to our homestead. On going to a back window I beheld the cause of the unusual disturbance. A bull pup, young and fat, sat at the foot of the back steps, howling for admission to the house. The comical appearance of his round body, benched legs and angular head struck me so forcibly that I laughed aloud. At this he turned on me a face seemingly full of solemn reproof, then in strident but resolute tones he gave the rebel yell, and charged the steps. Becoming interested, I lingered to



A BROAD GAUGE PUP.

watch the result of his designs on the back door.

He took the first step with little difficulty, but at the second he missed his footing and fell back to his first position. Without a minute's delay he collected his forces and charged again, taking several steps with a grand rush. An attempt to finish the ascent brought fresh disaster, for he made a false move, his pothooks failed him and he fell to earth again. After several vain attempts he sat down at the foot of the steps to *reconnoitre*. He gained fresh courage as he viewed the scene of his repulse, and soon went to work again with more deliberation. At last he reached the top step, but there a new difficulty con-

fronted him. The door was closed. There was no landing, and the footpiece was too narrow to accommodate even a small bull pup. Nothing daunted, he lunged at the closed door, but, alas, it yielded not. He fell back, and his little round body seemed fairly to bounce on the steps as he descended, without a whimper, to sprawl at the bottom, defeated on the very threshold of victory.

This incident gave him a name, for he was thenceforth known as Bounce.

Finally I let him in, and installed him as a member of the household, where he proceeded to make himself thoroughly at home.

As he gained in size he became even less comely to look on. He acquired better control of his legs, and could mount the back steps successfully, but he lost his plumpness, and became in appearance what a sculptor would call "blocked out." His lips looked as if the drawstrings had been broken, for they hung loose in several places, and his glistening teeth seemed to belie the friendly but almost imperceptible wag of his thumblike tail.

The desire for occupation and diversion common to all puppies found peculiar expression with Bounce. He formed the habit of gathering rubbish, or even useful articles from the house, and burying them in a corner of the back yard. Rags, bones, broken crockery, etc., all went to Bounce's burying ground, and sometimes good shoes and hats had to be rescued from an untimely interment. His movements were always deliberate, and on these occasions he assumed an extra dignity. His face, serious at all times, would then wear a most solemn expression, so that he soon became known among us as Bounce, the Undertaker.

On one occasion, while seeking material for a funeral, he chanced on a small wooden hoop. He had passed many an hour playing with this same hoop, and had seemingly become as much attached to it as any child to a toy. It had once caused him keen delight by accidentally rolling down a small incline, and he tried for half an hour to induce it to roll again. It had a mysterious way of entangling itself with his feet when he was at play with it, and sometimes it would rise up and smite him sharply in the short ribs; but now Bounce was wearing his "Here to-day and gone to-morrow" expression, and the hoop was doomed. He bore it with becoming dignity to a soft spot near the currant bush, and dug a hole. Then a difficulty was

met, for when one side of the hoop was pressed into the grave, the other side rose up in a most unexpected manner and balked the ceremonies. After several fruitless attempts to entomb the hoop, the dog sat down to ponder the situation. It was his first problem in engineering. He was no mathematician, but he showed that he was up to his work by placing the hoop on level ground and drawing the loose earth over it until it was entirely covered by a circular mound. Then he walked slowly away, looking very much like a bereaved relative.

A family of brindle kittens shared the hospitality of the woodshed with this enterprising pup. They were of the mewing, watery eyed age, uncertain of gait, and much attached to their place of birth. Bounce had repeatedly tried to coax these small creatures into sportiveness, but they remained unresponsive, so one day he decided they cumbered the earth to no purpose. He took one of them up by the skin of its neck and proceeded solemnly, I had almost said tearfully, to his private graveyard. Digging a suitable hole, he placed the passive kitten therein and settling it carefully with a poke of his nose, he drew in the soil and packed it firmly. Satisfied with the progress made, he again visited the woodshed, but on returning with his second victim, he found, much to his chagrin, that corpse number one had revived, and was even then scampering away as fast as its wobbly legs could take it. He dropped the second to fetch the first, and the second fled also. They played that on him but once, however, for he soon got them both in his mouth and took them again to the grave. There he dropped one and held it safe by putting one foot on the slack of its skin, while he cleared and enlarged the grave with another foot. This done, he covered the kittens, rammed them

down with his muzzle, and I think perhaps would have sat on the grave to hold them securely until such time as they might consent to remain quiet, had they not been rescued by a member of the household who felt obliged to go on record as opposed to the burial of live cats.

When Bounce matured he was, generally speaking, an amiable watch dog. He would not suffer a tramp in sight, however, and would bristle and work the drawstrings of his lips until there were enough great, white teeth in evidence to discourage the boldest Willie. Among his own kind he soon became known as a good dog to be let alone. It could scarcely be said that he ever took part in a dog fight. He always allowed his opponent to make the first dash, and he never failed to get a good throat hold. There was no fighting to speak of after that.

One day Bounce went to a field remote from the house, with a hired man who was to leave the place the next day. The man returned without the dog and went away the next morning. It was not until then that the dog was missed, and he was not seen again until the second day. When he came he was fed at once, and as soon as he had finished his food he again disappeared. Late in the evening of the third day, after he had gone to the field with the hired man he again appeared, dragging with his teeth an old coat which the man had left on a stump. Faithful Bounce had guarded the coat 3 days, and getting tired of his lonely job, had decided to remove it to a place of safety, crossing several fences on the way. The coat was given him for a bed, and served to keep him warm that winter.

Bounce has put off his puppyish tricks, has retired from the funeral directorship, and is now a dignified, faithful and useful guardian of the house and its inmates.

THE COWBOY'S SONG.

C. T. L.

Oh! for the life that's free from care!
Oh! for the land where men are men!
To breathe once more that fresh free air,
Down by the forks of the Dry Cheyenne.

To feel the bronco bound to the spur,
To feel the stout rope tighten, when
Your horse lies back to the steer's mad
plunge,
Down by the forks of the Dry Cheyenne.

To others the faded life of town,
For me a horse and a gun, and then
The swelling plains and the pine-bound
hills,
Down by the forks of the Dry Cheyenne.

To hear the click of the countless hoofs,
To hear those rattling horns again
As the herd stampedes some wild, dark
night,
Down by the forks of the Dry Cheyenne.

To see the grim, grey wolf at dawn,
Sneak through the hills to his rocky den,
To start the buck from his leafy bed,
Down by the forks of the Dry Cheyenne.

ONE OF THOSE FLOWING BOWLES.

H. P. GILLETTE.

I have long been an interested reader of your excellent magazine. Seldom have I experienced more genuine pleasure, however, than in reading Mr. J. H. Bowles' contribution, "The Tye Salmon in Puget Sound," which appeared in RECREATION. Coming as this does from my old home, it brings back the scenes, not to mention the smells, of my childhood. The Siwash pen picture of old Jack and his squaw are to me like the old oaken bucket that hung in the well. I see them, and forthwith come visions of the oozy tide flats, and the calm-digging Siwashes. I hear again the Siwash jargon with its whistling notes like the squirting of those bivalves on the tide flats; but of those I did not start to write. My thoughts center rather on the wonderful changes that have come to pass in the few fleeting months since last I rubbed noses in long sad farewell with my good old friend, Siwash Jack. I rejoice to hear that he still lives, and wonder whether he smells of clams as of yore, and—but I am again growing reminiscent.

Old Jack is still there, but what a change has come, not only over the face of nature, but over her handiwork as well! I see, by Mr. Bowles' pen picture, the bald headed eagle has at last migrated to Puget sound. When I was there this monarch of the sky still made his eyrie far up among the grand crags of the Rocky mountains, where roll the thunders and hear no sound save their own crashing. Now all is changed. The bald eagle has come to Puget sound to battle for life with the crow. Yet strange as to me this all seems, 'tis stranger still to read that Mr. Bowles "finally became absorbed in watching the onslaught of a flock of crows on a pair of bald eagles, whose nest was in one of the giant firs."

Wonder not at his absorption! As for me, I marvel; but rather that Mr. Bowles, the first human being who ever saw a bald eagle's nest in a tree, that he, though he had gone to fish, did not remain to pray.

These be strange days; and Mr. Bowles pauses not to write of commonplaces, when stranger things remain to be chronicled. Dragging his eyes from the eagle's rocky eyrie in the "giant fir," he finds that a tye with a stomach like a reel has swallowed everything but his rod. There follows a battle royal between the reels of the tye and of Bowles, until the latter wins.

A moment later Bowles is again thrash-



A BATTLE FOR LIFE.

ing water into foam with a silver salmon; and hardly has he gaffed his prey than he finds himself struggling with a mammoth rock cod. So he goes from fish to fish, never sighing, like Alexander of old, for more worlds to conquer.

I protest against the brevity of Bowles. When a scientist makes a discovery he owes it to himself and to the world to give in full the story of his struggles. Bowles is altogether too loose in his statements. Brevity may be the soul of wit, but Bowles is not giving us wit; he is describing things that no human eyes but his have ever seen; a bald eagle on Puget sound, an eagle's nest in a fir tree, a silver salmon in an eddy, a tye, or steelhead, salmon there also, and the time, February, 1902!

Why February? Answer, the bald eagle nests only then. Why 1902? I was there myself in 1901, and before then with old Siwash Jack; and February, 1903, has not yet come.* Thus, like Sherlock Holmes, I find the exact date which Bowles neglects to name. I might e'en get down to the very day of the month, but what boots it? I pass on to other wonders chronicled by this worthy literary descendant of Dar-

* This story came to me in 1902, but has been held over till now because of the quantity of matter in hand when this came. Editor.

win. Again I quote: "For half an hour we rowed slowly along; watching the kingfishers retiring for the night to their holes in the cliffs."

Gone, gone, are the scenes of my childhood! Cliffs now tower where once the pine-clad slopes upreared their crests to the sky! And kingfishers—thieves always—have stolen the bank swallows' nests, and rear their young in holes!

Ah! Bowles, thou makest me sigh. No more may I go back to my clammy tide flats and rest my eyes on the verdured hills; hold forth my arms and cry, "Home

am I come, and ye do smile a welcome sweet to me." Ah, no! 'Tis all gone. The cruel, relentless hand of time hath hewn those rolling hills into cliffs, where the kingfisher burrows like the mole, and the eagle, tired of his craggy home, sleeps in the swaying top of the giant fir! The tye, which once ran in the ides of March, and the silver salmon, which came only in July, now breathe the same water, and together, like children in the song, "holler down the same rain barrel!" But why repine, the world still moves! And Bowles? Who can doubt it? He hath spoken.



ENEMIES AT PEACE.

AMATEUR PHOTO BY FRANK E. PONTING

I enclose a photograph of 2 ferrets and 2 common house rats occupying the same cage and living happily together. Of course, the cage shown in the photograph is not their permanent home. They were placed

there to be photographed. They were brought up together from young and feed from the same troughs.

Frank E. Ponting,
Malmesbury, England.

"Jack, dear," she sighed, "Jack, when you are gone I shall pine away."

"Don't," he answered, adding, with an uneasy laugh, "don't pine away; spruce up."—Princeton Tiger.

BY THE HARDEST.

AMOS GRAYSON.

I've forgotten the make of gun and can't recollect the brand of powder.

Jim came and disturbed me at a time when no civilized man should disturb a civilized fellow man. It was so early that it must have been the day before. He shook me awake and said:

"Squirrels ripe. Hustle out."

Squirrels were ripe and some fell to the ground. We picked them up and bagged them.

I would not undertake to say how far we walked that morning, for I am afraid of a treacherous memory; but we made the rounds. There was the tall shell-bark over on the ridge; then the clump, back up in Wind hollow. Over on the Molohorn place were more hunting grounds.

Then we went to the big forked hickory at the foot of Dug hill.

We had no dog. As we stole within range there was a flash of rusty red up in the branches.

"Gee whittaker," said I, "a fox! Didn't know foxes climbed trees. Can't be a squirrel?"

"It's both," said Jim, "and what we've got to do is to get him."

We didn't get him. Several times we saw him, or thought so.

The peppering we gave the spot where he seemed to show preserved no meat. I can't say that the hunt was conducted on strict sportsmanlike principles. I was new to the game and had a new double barreled, breech loader out for the first time. Jim was a good hunter of the backwoods type, 6 feet 2, but would have killed that squirrel with a fence rail if he could.

I think we wore a runaway around that tree. I had to lift my neck straight when I quit looking for the squirrel.

"Let's both start away," said Jim. "I'll go on to where there's another tree. You sneak back and hide in the brush and maybe we'll fool him."

The squirrel was no fool and he knew it. In half or three-quarters of an hour Jim came back. Maybe I was reading, or meditating, or asleep. Jim says I was asleep, but I deny it. Anyway the old fox was safe.

"Let's lambast him," said Jim. "We're going home, anyway."

We shot into every clump of leaves. I'm afraid we got rattled. We threw rocks.

"Let's scare him to death, anyway," said Jim.

He didn't scare worth an empty shell. I'm also afraid the squirrel was worth several dollars before we let up on the bombardment.

"Let the gol darned critter go," said Jim. "I'm getting hungry."

I remember he said that after all his ammunition was gone.

I claim the merit of prudential restraint of the destructive instinct inherent in every son of Adam. I started for home with one shell left. I claim that merit, and be it noticed, 'tis all I do claim in this matter.

What prompted me to stop when we had walked some distance, and request Jim to notice if my gun would carry back as far as the tree, I can't say. Certainly all thought of slaughter had left my mind.

"Jim," said I, "watch the Big Fork and see if this gun can reach from here. I'll aim at that clump of leaves half way up. See if any of the leaves are hit."

With that I cracked down on—my thumb. I shall not attempt to explain that, but 'tis so. I can show the scar in proof. I forget now what Jim said, but I always maintained that I had the most right to the say so at that time. I thought the gun burst when I tried again, for Jim let out a yell that scared me. As the smoke cleared I could see Jim going toward the tree. There was a 10-rail fence between it and us, also a brier patch behind the fence. Jim, you remember, was 6 feet 2. He was disappearing in the brier patch when I first saw him. He was whooping and I thought the briers were hurting. I think he jumped over that fence and never touched it. I know he touched the briers. I couldn't understand this caper till my eye caught something rusty red dropping, rolling, clinging, dropping, rolling, slipping from fork to branch, from branch to leaf. It was the squirrel!

The recollection of what followed is vague. It was some time before I got the courage to visit that neighborhood again. You see the people there are religious, and we must have disturbed them. I forgot to state the day was Sunday.

I have not tried too hard to analyze the whole matter, but we must have exulted aloud and with motions.

There was one pellet through the heart of the squirrel. The distance was 60 yards to the foot of the tree. That was my first hunt. I have since been reading RECREATION, and I don't shoot squirrels now.



KIT RAISED THE WHIP HIGH IN THE AIR.

KIT, THE TALE OF A MULE.

FRANK S. ELLSWORTH.

Without a doubt she was the worst mule I ever saw. Of course, Jack, having passed so long years in harness, was full of sense; but Kit, his worser half, was younger and more ambitious in her mulish way. A lady mule can not be ambitious and retain the respect of her betters. The couple was childless, and, as is sometimes the case with childless couples, they quarreled. Kit was unquestionably the corporal of their *rancho*. When Jack would ask



A MURDEROUS GLEAM IN HER EYE.

permission to go to lodge, or to go out with the boys, Kit would curse like a pirate, kick him a time or 2 in the ribs, and effectually prevent his going out that night or for several nights thereafter.

Living for months in close proximity to Kit and Jack, I learned a great deal about both of them. A natural taste for languages enabled me to master the rudiments of mule grammar and language, thus getting an insight into mule thoughts and character denied my less fortunate companions. Later researches have convinced me that the mule language is a derivative of that of the asses, with a considerable admixture of words from the horse tongue. The mules have brought a few words in pristine purity from their original home beyond the Caspian, whence they emigrated

with that branch of the Aryans which entered Europe near where Constantinople now stands. The most ancient word of the pure mule tongue which now occurs to me is "Yaw-he-haw," meaning "oats;" conclusively proving that the Indo-Aryan tribes were farmers and raised the grain mentioned. However, it is not of mule philology and history that I wish to speak at this time. Rather of certain unladylike traits which Kit exhibited when on the desert, many leagues from home.

I was not with Kit and Jack during the day, and I heard little of their conversation when they were at work; but when lying on my cot in the evening I have often overheard their complaints, little caresses, and schemes. Together, but at her instigation, they had several times taken jaunts during the night, with no intention of returning in the morning, until Dick, the teamster, almost as a last resort, had hobbled them.

Late one afternoon we camped on the bank of El Chicon, a large water hole Southwest of Uvalde. That night, as the mules were being fed, I heard Kit remark:

"You divide the corn to-night, Jack dear, and don't forget I want to see you a few minutes after the moon sets."

About 3 hours later, as the teamster, topographer and rodmen were playing their everlasting euchre, Kit, who was standing near my cot, was whispering to her better half.

"Jack," she said, in an earnest tone, "I was frightfully abused by that teamster to-day, and I feel terribly cut up about it. Feel those long ridges just in front of my left hip."

He felt of them, and asked, "Well, what are you going to do about it?"

"What am I going to do about it? You heartless brute! I shall leave this place to-night and you must go with me. I heard the chief, that fellow with the black beard, tell Dick to-day that in less than a week we will be on rough roads again. If you think I intend to get my back and collar-bones all spotted with sores again, you are a mistaken mule!"

"But, Kit," Jack interrupted, "we were all through Burnet, Llano, and Mason counties last year, on the roughest roads either of us ever saw, and we both recovered."

"There you go! Always satisfied! Never trying to push ahead unless Dick is after you with that blacksnake whip! I don't believe you would leave a sure ear of corn for the possible chance of everlasting free-

dom. Now look you, Jack, do you remember the shade, and sweet grass, and cool water at Olmos creek? To-night I shall strike out for that place, and if you have any mulehood about you, you will go with me. There we will be free, no work and all play for the rest of our lives."

"But, Kitty, what will they think of us?"

"What will they think of us?" she repeated slowly, and with that delicate scorn of which the mule is master. "What will who think of us? If you mean this gang of toughs that Dick is with, what do we care what they think of us? Should we stay here, and have our lives beaten out of us when the freedom of the prairies is before us?"

Jack was thoughtful, and as she stopped, he said, meekly,

"Lead on, dear, I will follow you."

Three days later, after a fearful waste of profanity, 2 wobegone but hopeful looking mules were found 20 miles from camp, standing behind a mesquite bush in silent meditation. They had lost their way. As Dick, on horseback, galloped into sight around the bush Kit gave a scream.

"Good Lord! Jump, Jack, jump!"

Whack! Whack! Whack! fell that terrible whip on her long sides until she cried for mercy.

"Oh, Jack! Jack! Help me! Kick the brute! Kick him! Kick him!" But the blacksnake fell on her without pity.

Kit was pigeon-toed in her left hind foot, and, as in the case of the crosseyed man, one could never tell where she would strike. As Dick dismounted on arriving at camp the whip slipped from his hand to the ground, not 2 feet from Kit's left hind foot. In a second she had planned a fearful revenge, and there was a murderous gleam in her eye as she estimated the distance from her hoof to the whip. As Dick lifted it from the ground, with a curse on her lips, Kit sent her left hind foot out like a catapult, and raised that whip high in the air. For an instant it hung above our heads, then fell into the watery depths of El Chicon, and was felt by Kit no more.

Whatever else Kit might say about us she could not say we were ungrateful. Of course Dick occasionally applied the blacksnake, but even a saint would have done that, and Dick was no saint. No, we had been good to Kit, and her rash act of eloping with Jack, if even a mule lady can elope with her own husband, followed by that of practically stealing our whip, ruined her reputation beyond repair.

Never again did we pitch a camp, after her foolish, mulish escapade, that we did not fasten a rope about her neck and tie her securely to a tree, while the hobbles were removed from Jack's legs forever. Kit afterward told Jack that in providing him with a few days' freedom and ridding him of the whip, she had brought on herself a cruel persecution.

\$15,000 REWARD!

This foreign lady suddenly appeared in Devon, Pa., near the Cathcart Home. She spoke only Spanish and Hawaiian, though she seemed to be from the North, to prefer



A BOSTON GIRL?

the coldest outdoor weather, and to be singularly independent of the comforts of friends in the Academy of Fine Arts. She was lonely, as she was far from her "ain countrie," and had no living relatives, and, I am sorry to say, she was badly frozen, as she refused to come in out of the cold. She "would soon go to a warmer climate."

One night she vanished as suddenly as she had come. The Arabs never folded their tents and stole away more silently, modern civilization.

She was Eastward bound, probably for the Hub, where there are kindred spirits, some of Carlyle's "Snow and rose bloom maidens," and where she had some old I fear there has been some tragedy, but hope for the best.

Fifteen hundred dollars reward will be paid to anyone who will return her to me. I feel a natural interest in her as I discovered her onē cold, starlight night, alone in the woods near, and brought her out, hoping to save her for future usefulness; but with the first breath of spring she fled.

Thos. L. Gulick, Devon, Pa.

A DEER ACCIDENT.

B. BOULDER.

No country of an equal area, easily accessible to Arizona sportsmen, fulfills so well as Loconino county the conditions necessary for mule deer hunting. The deer are there by the dozen, and mighty wild. So much the better, when one wishes real sport. One cold morning I started out from a little town in that county to take a deer hunt up in the mountains. The snow lay about 3 feet deep everywhere and there was a cold wind blowing from the North. We made camp 40 miles back in the mountains in a canyon.

The morning after arriving we started for the highest mountain in the immediate vicinity. Reaching the foot of the mountain, we saw plenty of deer tracks, and formed our plan for the day's hunt by them. My chum, Sam, was to go in a Westerly direction, and when half way around, start for the top, while I was to go around the other side, and when half way was to sit down and wait for Sam to come over the top and meet me. Sam was armed with a 40-60 Marlin repeater, while I had a 12-gauge Winchester shot gun with buckshot. I used the latter from necessity, not choice.

Reaching my destination, I heard Sam shoot 4 times in quick succession, and I knew he had found deer. In another second I saw something go behind a pile of brush at the top of the hill, but could not make out what it was. I started toward the object, when Sam shot again, and a big buck lurched forward and fell, to rise no more. Three more came tearing down the hill, 50 feet at a jump, straight toward me. I raised on one knee, covered the big bunch of horns in the lead, pulled the trigger with a quick aim, and another buck jumped his last. Another buck, bigger than any I had seen that year, succeeded in jumping behind a pile of brush and thus escaped me, although I shot twice.

About that time Sam came in view at the top of the hill, and was surprised to learn that his deer lay within 30 feet of where he stood, for he thought he had missed, as the deer made one jump after he fired, and then was over the hill, out of his sight. I told him I had another deer wounded and wished to give chase, and asked him to lend me his rifle, which he willingly did.

Then I started to trail my deer. Of course, I knew better than to follow his track altogether, so I worked around in the canyons awhile and came out on a bit of hill ground which he had crossed. I had found no blood, but I would not give up. I worked till afternoon, and was just

ready to call it a bad job, when I saw through a gap in the pines my deer, standing still, entirely unaware of my presence. I crawled within 90 yards, and sent a 40-60 on its way for the buck's shoulder. He went down, but quick as lightning he was on his feet again. I was ready for him, and to make sure, I raised the rifle to my face, took careful aim, and pressed the trigger. Then there was a deafening report, like a charge of dynamite. For a few minutes I was paralyzed. My right hand hung limp at my side, and felt as if it was over a hot blaze. I quickly raised it to see what could be the cause of this, and, to my horror, my hand was nothing but a lot of mangled flesh and bone, and was bleeding frightfully. I did not lose my presence of mind, but took a white silk handkerchief from my pocket and quickly bound it around my wrist to stop the flow of blood. I thought of Sam, but I knew he could do nothing for me, so I started for camp, which was over 4 miles away. I will not attempt to describe my suffering as I traveled that 4 miles, down deep canyons, over hills, through brush and deep snow. At last I came in sight of camp. I do not know when a camp looked better; it seemed to me the only place in the world. I was weak, black clouds passed before my eyes, my mind left me.

After a time I could see Sam bending over me, trying to force some brandy between my teeth. At last I was able to sit up and talk to him. He had heard me shoot, had gone to where I crossed a ravine, had seen the blood on the snow, mistrusted that something was wrong, and had followed my trail to camp.

We made up our minds to leave. I shall never forget that night's ride, but never was a team driven over that 40 miles in less time. We made it in 9 hours, and it was over as rough a road as any one would care to travel.

After a week, against the orders of the doctor, I again pulled out with Sam for the scene of the accident. When we arrived there, I could see the cause of the rifle's exploding. It occurred in the magazine. It was caused by the spring in the tube, the cap in the end of one of the shells, and a bullet in the one directly behind the former. Anyone well acquainted with the Marlin magazine rifle can understand. It was mere luck that I did not have my head blown off.

The deer we had killed the week before were in good shape, being well frozen.

There were 2, but not enough for us. We were entitled to 4 by law, it was our last chance, and we wished to use it. My hand was by no means well. I still carried it in a sling. When I wished to use my rifle I slipped my hand out, laid the barrel across my elbow and could shoot fairly well. Sam and I separated, intending to bring our game to camp before dark and in time to fix up the horses so we could start back to town in the morning. I had been gone from Sam about half an hour when I heard him shoot. He beat me again, but the same thing happened. He was driving the deer to me for I had not walked over 300 yards when I was aware that 2 deer were coming down a hill directly in front of me. When I first saw them they were too far away to shoot, so I waited and they came on.

When they were within 100 yards of me they suddenly turned to the right. Now or never! I twisted a 30-30 soft nose through a good rifle barrel, and headed it for the same old place. The deer stepped out of the way and the bullet smashed against a big rock. He turned around and I dropped another bullet in front of him. Then he wheeled and came straight for me. I think he was guessing hard. He came to a clump of brush and stopped within 50 yards. I made him a present of another 30-40, and he received it in the heart, dropping where he was. I went to him and found I had hit him through the shoulder. There was an old wound also, so I turned him over and found, to my own satisfaction, that he and I had met before.

THE 1903 REGISTER.

DR. J. S. KENNEDY.

A register was sent from Washington to me,
 It opened at the old Fifth Horse in a familiar way,
 But were it not for a few things that woke a tender chord,
 I should have sworn that roster false and proved it with my sword.
 Those few remained, but higher up I noticed them to be
 Than when we last saw Skimezin in his rude rancheree.
 They're higher up than in the days when Superstition Mount,
 And Slim Buttes by the subs were held as scraps on which to count.
 As I viewed this register, outgrown in shape and size,
 A kind of hazy atmosphere seemed settling 'fore my eyes;
 I was again upon the plains beside the treacherous Platte,
 And scouting on the Yellowstone led by the Little Bat.
 It seemed as if I jogged along, the way we used to go,
 Across the bad lands guided by Bill Cody and Old Joe.
 And o'er the Arizona trails through canyons deep and grand,
 With noseless Cooley leading on the Aravapai band.
 With thoughts like these what wonder I should turn

To this new register, surprised and with no small concern.
 Or that I should exclaim aloud as if the walls had ears
 And tongue to free my mind of doubts and hopes and fears.
 "Where's Emory, Duncan, Hart, and Crit?
 Where's Jaky Gordon? Where?
 Where's Billy Royal? Do you dare to say they are not there?
 Where's Mason, Burns and Gassy Brown?
 Where's Sinbad, Prince and Payne?
 Where's Charlie Rockwell, Rodgers, all brave knights without a stain?
 Where's Almy of San Carlos fame?
 Where's Bobby London, say?
 You know t'was Bob that Charlie King gave to the world in Ray. I——"
 But here a voice both shrill and strong broke in and sternly said:
 "Go mix yourself a toddy, Tubbs, those fellows are all dead."
 A sadness fell upon me, then, I felt aggrieved, oppressed,
 And to the wraith that spoke to me I thus myself addressed:
 "T'is many moons since I have drained the bracing, stirring cup,
 But come, my man, bring forth your grog and fill the beaker up;
 It must be that I'm getting old and ebbing with the tide,
 How? Here's to it! I'll strike their camp beyond the Big Divide."

ANTOINE'S CARIBOU.

E. W. PARKER.

Mos' de beeg bug got de craze for catch a deer. T'ree, 4, 5, mebbe, go on Megantic 2, t'ree week an' have bully tam shoot de pheasant and de duck an' hunt de caribou.

Ah'm lak dat mahse'f, an' w'en Ah got finis' dig mah petteetto Ah'm decide in mah min' dat Ah'll go tak' some caribou for mah fambly, 'nough lass all winter. So Ah gon over cross 'bout 4 acres w'ere 2 feller Ah know, Jo Garceau an' Pete Gonneau, was mak' slash. Ah ax heem come wit me lass week an' hunt caribou. Pete ax me,

"W'ere you gon', Antoine?"

Ah say we gon on Brompton lak, or Lak' Scratch-roun'-to-meet-us. Jo say Brompton bes' plas an' he go in for dat wit' all hees heart an' hees new gaun, too; so we 'gree for dat an' Ah gon rat home for feex mah gaun.

Mah fadder give me dat gaun mos' 30 year ago, an' hees fadder give it to heem more as 40 year 'fore dat; mah gre't gran'-fadder tak' heem from Capen Bung w'en he fight de Injuns below Quebec on Montmorenci. Bah gosh, Ah'll smash de target evertam wit' dat gaun, he's bes' Ah never see.

Nex' mornin' Ah'm got up hearly for ron down an' buy hammunition an' gon to butcher's for piece meat las' mah fambly w'ile Ah'm huntin'. Ah see dere 2, t'ree pooty leetle deer wat come down Megantic for sell it. One have awful pooty tail, an' Ah'm tol' de butcher will he give me dat tail; Ah want heem for mah leetle gran'son. He mak' remark he ant see w'at mah gran'-chil' mak' wid a tail. Ah tol' heem Ah go ver' of'en see dat leetle feller an' we have bully tam play de sojer, an' Ah'll pin de tail on hees cap an' mak' heem feel beeg.

So Ah'm gon home an' load mah fusee. He tak' t'ree finger paouder an' han'ful buck shot an' he's ready for bus'ness. He mak' some hexecution w'en he's gon off, hem?

We jomp on woggin an' 'way we gon to

Brompton. We mak' joke an' have good tam, an' bimeby Jo ax me:

"Antoine, w'ere you gat dat ole gaun?"

Ah'm tol' heem de whole historee, an' he offe bet hees dog Ah ant able hit de lak'. He show me hees rafle an' brag gre't deal. He say it repeataire an' shoot 15 tam an' load heem o'ny fust tam.

We 'rive on de lak' and Jo tie tree on hees ole hoss, an' we plunge in de fores', heverybody for heemse'f go hunt w'are he min' to.

Ah'm put on mah mogasin an' go ver' slow. Pooty soon de fores' all close in an' Ah ant see Jo an' Pete. Bimeby Ah 'rive on one slash an' Ah peek t'rough de bush. Rat dere, not 4 rod 'way, stan' my caribou! He look lak he 8 foot high an' on'y want for heat me. I turn roun' an' lay mah gaun on log an' look for steek to hit heem. Bah gosh, Ah'm 'fraid he bite me. De col' cheel ron up mah back an' Ah tak' mah cap an' t'rough at heem an' yell lak' a dev'? Mah soul! he jomp more as 40 foot; jomp, jomp, an' hees gon'!

W'en Ah compose mahse'f de firs' t'ing Ah'll see is mah gaun an' Ah say,

"Antoine, you condemn ole fool, you ant know not'in'." Ah grab de gaun an' tak' good aim at de bush w'ere de caribou ron t'rough. Ah let heem go an', sacree cochon, how he roar!

Pooty soon Jo an' Pete come ron on de slash an' ax me, "W'at you kill, Antoine, w'at you kill?"

"Ah'm shoot beeg caribou," Ah say. "Ron, ron, los' no tam an' we'll gat heem."

Dey laugh an' ax w'ich way he's gon'. Ah show de trail, sure 'nough, an' Ah tak out de leetle deer's tail ver' sly and mak' b'lieve Ah'll foun' it. "Here's hees tail," Ah say. "Ron, Jo; ron Pete, you'll catch heem 'fore he's gon' 2 acre."

Dat las Ah'm see of Jo an' Pete, an' de caribou, too.

MEN OF THE SUN AND RAIN.

R. B. NATTRASS.

Men of the sun and rain for me,
Men with the cheeks of tan,
Who love all good things ardently
But most, an honest man;
Whose grip of comradeship is strong,
Whose simple words are true,
Men, if a multitude were wrong,
Would battle for the few!
Such are the men for me indeed,

Men of the fresh turned soil,
Whose rough hands preach the noblest
creed,
The creed of manly toil.
They may be poor, as riches stand,
Their manners crude and plain,
But they're the kings of any land;
Men of the sun and rain.

MOUNTAIN BADGER.

ALLAN BROOKS.

This badger was originally described from Fort Crook, Shasta county, California, but it also occurs through the mountains of the interior as far North as Southern British

but unlike them, the badgers do not ascend the mountains to timber line. Their food consists of these squirrels and many other small mammals, as well as insects, fruit,



MOUNTAIN BADGER. *TAXIDEA AMERICANA NEGLECTA* (MEARNS).

Columbia. The Nanagan district is the only locality where I have met it but it is probably found locally throughout the semi-arid portions of Southern British Columbia. Nowhere have I found it numerous; one or 2 pairs being found at a time in wide stretches of country. A stray one occasionally turns up in unlooked for localities. Generally speaking they are found wherever there are colonies of ground squirrels,

roots, etc. I do not know the period of badger hibernations and was surprised to find them traveling about last winter, through deep snow, from burrow to burrow, often $\frac{1}{4}$ of a mile apart. This was in December and the weather had been uniformly cold. In a trap these badgers fight well; more so than any other animal except perhaps an otter. The weight of an adult badger is about 18 pounds.

A. Fusser—What would you do if I should kiss you?

Mary McLane—I should scream for help.

A. Fusser—Why? Don't you think I could do it alone?—Pawtucket Gazette.

HIKING IN RIZAL.

CHAS. H. STONE.

I recently took a trip into the province of Rizal, and although I did not shoot any game I saw plenty of evidence that it was there in abundance.

I took the boat from Manila up the Pasig river into the Laguna de Bay, a lake 70 miles long and 35 wide, and about 10 miles from Manila. I had the good fortune to meet a friend on the boat who lives at Tonay, and who insisted on my accompanying him home.

While going along the shores of the Laguna de Bay we saw numerous snipe and large white cranes. The latter are sometimes called caraboa cranes, on account of their often being seen in company with the caraboa, or water buffalo. The natives never molest these birds, though their eggs are gathered and sold in the markets as duck eggs, which they resemble, but are somewhat stronger in taste. We also saw thousands of ducks, which are little hunted as yet, the natives having no guns, while few shot guns are owned in the islands by Americans and Europeans.

After reaching Tonay we endeavored to secure the services of several natives as packers for our provisions and camp outfit, and after considerable trouble we managed to hire 5. Generally we have no trouble in securing natives, but as the fiesta of the pueblo (holiday of the town) would commence in about 5 days, they did not want to risk the chance of missing it. The only way we managed to get them was by promising we would be back the day before the fiesta.

This particular town celebrates 217 fiestas in a year, besides Sundays. The civil government has enacted laws regulating holidays, and most of the fiestas formerly observed have been discontinued in Manila; but in the provinces the old order still continues. Each town is controlled by a presidente, corresponding to a mayor in the United States, and as they live an easy life and draw a good salary, they do not interfere with the pleasures of the people; and unless these mayors harbor *ladrones* the government does not interfere with them.

We started on foot the next morning, each native carrying about 150 pounds, divided in 2 packs, which were slung one at each end of a short pole. They carry these loads without apparent effort, taking a kind of dog trot and keeping it up half a day at a time. We made 10 miles in 3 hours, going over a range of foothills about 500 feet high, and finally arrived at our destination in a deep valley at the foot of the main range of mountains.

On the way we flushed many quails and a wild chicken. The quails are no larger than robins, while the chickens are a little larger than bantams. The chicken we saw was a male, and as he flew across the trail he presented a most beautiful appearance, with his red plumage and long tail. The hens are dull brown and smaller than the males. Every night and morning after we got in camp we heard these wild roosters crowing, and it seemed as if there must be a farm house not far away.

In our trips in the mountains we saw many tracks of deer and wild hogs, and even saw roiled water that they had passed through only a few minutes before, but did not catch a glimpse of any of the animals. They are trailed with dogs, and where Americans or Europeans are hunting, are shot as they come out into the open; but as the natives have no guns, they either spear their game or drive it into nets.

We saw several deer traps that the natives had set, and had to keep close watch that we did not get into them. They were generally on a trail between 2 close setting trees where a 2 inch sapling could be bent down for a spring. A stick lying across the path serves as a trigger, releasing the sapling, which drives a sharp stick through the deer's body.

Wildcats are numerous in the woods along the streams, but are seldom seen. Along the streams is found an animal closely resembling the alligator, except that it has a small head. Its diet is principally fish, though it is not averse to fruit, climbing good sized trees to get it. It frequently attains a length of 10 feet, with a breadth of 12 inches across the back.* The streams contain some good fishes, but not an extensive variety. I saw numerous gars swimming near the top of the water, but they are not good to eat.

Troops of monkeys are frequently seen, but they have been shot at so often that they soon make themselves scarce at sight of a man. Snakes are sometimes seen, though in our 5 days' tramp we saw but one, and that was only a foot long. Boa constrictors are found in these islands, and sometimes measure more than 20 feet in length.

About a year ago, as one of our ware-

*This animal is undoubtedly a big monitor lizard, similar to the kabra goya of Ceylon. It belongs to the genus *Varanus*, lives mostly on the ground, feeds on eggs, small mammals, birds and flesh of all kinds that it can catch and swallow. Ten feet is a great length for these creatures, but a particularly large and long tailed animal might attain it. This animal is active and strong and fierce in disposition.—W. T. H.

houses here in Manila was opened, a boa 14 feet long crawled from under the stairs near the door and was killed by the Chinos and Filipinos working in the warehouse. Its only desire seemed to be to escape, and it did not show fight. It must have crawled through a rear window from the canal that runs a few feet back of the warehouse.

While in the mountains we often heard the cry of a large bird similar to the buzzard of our Western plains. Its discordant

notes can be heard more than a mile. Crows can be seen at all times of the day.

In my travels in the islands I have never seen any members of the squirrel or rabbit family. I should like to see squirrels introduced here; they would never become the pest that the rabbit has proved in countries foreign to it.

The English sparrow is here, but does not multiply as in the States, and its presence is more pleasant than otherwise, as there is a dearth of birds in the islands.

WHO LOST IT?

Herewith I enclose photo of a freak of nature, known as the Devil's Chimney, which it well suggests. While going through the farming district of Green county, Wisconsin, a few miles north of New Glarus, one of the company sighted something in the distance towering above the treetops, and after driving almost a full

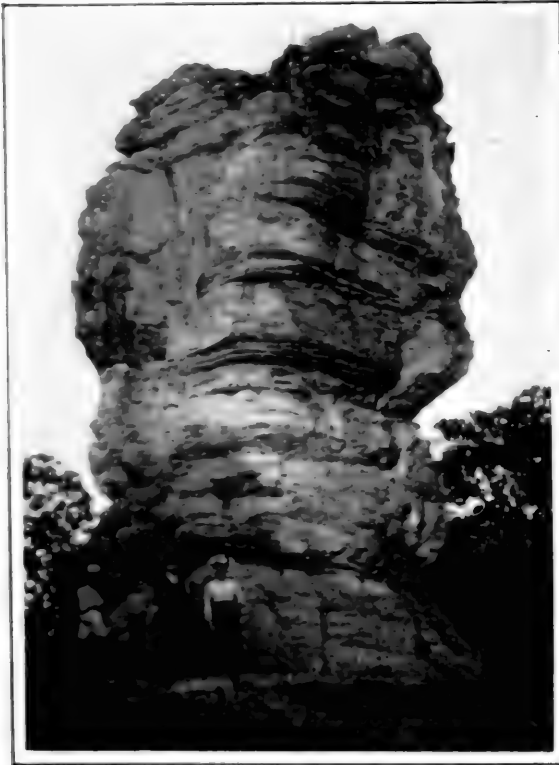

AMATEUR PHOTO BY WALTER WOHLWEND.

THE DEVIL'S CHIMNEY, GREEN COUNTY, WIS.

hour we came face to face with the object, as shown in the photograph. It proved to be a pile of solid rock reaching the height of about 45 feet. It is the only rock of any size for miles around.

Have been reading RECREATION for the last 2 years, and would not be without it. I enjoy your slashings of the game hogs. Give it to 'em!

Walter Wohlwend, Brackenridge, Pa.

A VALIANT WOODCHUCK.

A few days ago my wife and I, with a friend, took a stroll through the woods near here. My wife is a Kodak enthusiast. One of my friends took his Llewellyn with him, and my wife, who had been on the lookout for desirable views, suddenly discovered the dog engaged in a combat with a half grown woodchuck. The sight was



PREPARING FOR A RUSH.

worth seeing. The little chuck was the scrappiest thing of its size I ever saw. There were a number of mixups but the little fellow came out unscathed every time. My wife caught him as he was preparing for one of his rushes at the dog and I thought you might deem the picture worth a place in RECREATION. Out of regard for the valor of the little chuck, we called the dog off and left Chuckie master of the situation.

S. M. Keenan, Eloise, Mich.

She—The milliner told me she had been down to the dentist's to have a nerve killed.

He—Well, from the prices she asks for hats I should say the dentist must have killed the wrong one.—Stray Stories.

Invitation is the sincerest flattery.

THE NEW ARMY RIFLE.

In response to many requests I take pleasure in presenting herewith a picture of the new 30 caliber army rifle, known as the New Springfield. For comparison, I also show a cut of the Krag-Jorgensen, which has been in use in the army several years, and which has now been discarded. The new rifle embodies the best features of the old one and of the Mauser, and has been given exhaustive tests under such conditions as are likely to be met in active service. Most army officers, as well as expert riflemen in the ranks, who have used this new arm, are enthusiastic in its praise; but, of course, its real value can not be known until it shall be subjected to actual hard service in the field and in battle.

distant the bullet rises 20.67 feet; whereas the bullet of the Krag rises 25.8 feet. In shooting at a target 300 yards away, with the old smooth bore musket, used in our army before the Civil War, the bullet rose 129 feet at its turning point, which was 175 yards from the muzzle.

The New Springfield has a killing range of 5 miles, though, of course, it is impossible to see a man at that distance with the naked eye. The rifle is sighted for 3,000 yards, and is capable of dropping a bullet into a line of troops or a camp with deadly efficiency, at that range. At 55 feet the New Springfield has penetrated 54 inches of pine boards, and 6 inches of pine boards at 1,500 yards. The new rifle is claimed to



Upper Rifle—THE NEW SPRINGFIELD.
Lower Rifle—THE KRAG-JORGENSEN.

The New Springfield is of the class known as the clip-loading magazine gun, and is provided with a cut-off which enables the soldier to use it as a single loader, with the contents of the magazine (5 cartridges) held in reserve.

The new rifle weighs $9\frac{3}{4}$ pounds, which is about one pound less than the Krag. The barrel of the new gun is 24 inches long, while that of the old is 32 inches. The entire length of the new rifle is 43 inches as against 49 inches for the Krag. The bullets of both rifles are of the same weight, 220 grains. The powder charge for the New Springfield is 43 grains, whereas the Krag used 37 grains. This increase of powder charge gives the New Springfield a muzzle velocity of 2,300 feet a second, which is 300 feet greater than that of the Krag. The new rifle has a flatter trajectory than the old. In shooting at a target 1,000 yards

give practically no recoil when fired, and this, of course, adds greatly to its possible accuracy at all ranges. The barrel of the new rifle is entirely encased in wood, which gives it a somewhat clumsy appearance, but it has been determined by a long series of tests in actual service that this plan of construction is necessary in order to give the arm the highest possible degree of durability.

With the new gun, experts have fired as high as 15 shots singly and 5 shots from the magazine, in $15\frac{3}{4}$ seconds.

It will require 60,000 of the new rifles to equip the army and navy, and the Springfield armory is capable of turning them out at the rate of 250 a day. It is the intention to arm the militia of the various States with the new rifle, as soon as both branches of the regular service shall have been thus equipped.

How's your wife, Blinks?
Her head troubles her a good deal.
Neuralgia?
No; she wants a new hat.—Selected.

THE CHAMPION OF PUGET SOUND.

A. D. Austin, of Everett, Wash., writes a letter to Opportunity, a paper published in St. Paul, Minn., telling about the fishing trip which he and George Bakeman made to

picture shows something over 75 fish. Austin says, "George Bakeman is the champion trout catcher of Puget Sound and I venture to say he has few equals in the world."



A 6-HOUR CATCH OF TROUT IN PANTHER LAKE, WASHINGTON, BY GEORGE BAKEMAN AND A. D. AUSTIN.

Panther lake, Wash., last summer. He sends a photograph of their string of fish, which is reproduced here, and which he says measured 8 feet long. He also says the fish average 12 inches in length, and the

I move to strike out the word "catcher" in the above sentence and substitute the word "hog."

Bakeman's number in the fish hog book is 919 and Austin's is 920.—EDITOR.

GILBERT'S OTHER FAD.

My gentle hours of a lifetime have been given to the breeding of white fantail pigeons. I began with them in 1855, and have reared them to a point as near perfection as man can get them. In my opinion there is no handsomer bird. They are always in motion, and have a fascinating, coquettish style. They can be kept just like chickens in any kind of a coop that will keep rats and cats away. My pigeons are far more tame than chickens, for they fly all over me and my wife, and if we sit down a moment we are completely festooned with the little dancing beauties.

The bird of which I send you a photo is as handsome a little fellow as I ever raised. He has not yet been named, and I think "Coquina" would be about right. He is a revelation to those who have seen only the

ordinary scrub fantails, of which there are so many in all cities.

F. M. Gilbert, Evansville, Ind.



WHO'S IT?

OUR AND SOMEBODY'S ELSE BUCK.

FALCON.

Probably there are but few hunters in Pennsylvania who have not heard of the beautiful Diamond valley, in Huntingdon county, famed for its many deer. Sportsmen from afar visit the valley every year and few return empty handed. Of course deer are not so plentiful as in former years, but there are still enough to afford good sport. In that valley, several years ago, David L., who has been my hunting companion for many years, and I, enjoyed our first deer hunt.

An invitation had been extended to us by relatives living at the head of the valley to stay with them during the hunting season, and we were assured game was unusually plentiful that year. We took our departure by train early one morning in December. Reaching Petersburg we got off and started to walk to our destination, 10 miles away, over a rough road covered with 6 inches of snow. Encumbered by the weight of our guns and satchels. It was dinner time before we came to the quaint, old farm house for which we were bound. Dinner over, we decided to go down the valley a short distance to shoot grouse. We tramped through the brush 2 hours and bagged 8 birds; and were on the point of returning to the house when 2 hunters came along dragging a large buck over the snow. The sight so transported us that we could not wait until the next day to go deer hunting; so having taken our birds to the house, we started out alone, in a strange country, in quest of deer.

We had never hunted deer, but had read of the different methods employed, and decided to try still hunting. After wandering about the valley some time we heard the sound of a bell along the foot of the mountain. Knowing that a party of hunters near were belling for deer, we decided to keep moving along opposite the party, on the chance of their driving a deer toward us. We had double barreled, muzzle loading shot guns, into which we had dropped a number of buckshot over the bird shot. That was a great mistake, as we afterward found. We were both partial to muzzle loaders at that time.

We moved along until the sound of the bell became fainter, and finally died away, and it was apparent that the party had crossed the mountain. We were standing on an old logging road not far from the mountain, in a rather open tract, when I caught sight of something moving in the bushes about 300 yards distant, and called Dave's attention to it. Suddenly an im-

mense buck emerged from the brush into the open timber, moving in a line parallel to us. We had given up all hope of getting a shot at him when he turned and came toward us. We crouched behind a small thorn bush and with guns cocked, anxiously awaited his coming. The animal moved forward in a leisurely way, ever and anon cropping the leaves in his path. We remained rooted to the spot, spellbound with admiration, but strange to say were not seized with buck ague. When the buck had advanced to within 30 yards of us he suddenly threw his head high in the air with a loud snort. We were to windward of him, but nevertheless he scented us. Dave whispered, "Now!" We quickly brought our guns to our shoulders, took careful aim and fired. The monarch of the forest sprang high in air and fell, but regained his feet in an instant and rushed madly past us, taking immense leaps. I wheeled and gave him the other barrel broadside, just as he disappeared into a small ravine. Dave was behind me and could not get another shot.

Here we made the mistake of our lives by instantly starting in pursuit of the wounded animal. He had lain down after traveling a short distance, and had we waited a while before starting on the trail, he would have been so stiffened as to be unable to rise, and we could have made short work of him. His foot marks were covered with blood, and the irregular manner in which they were made showed that he was moving with an uncertain, staggering gait, badly wounded. The trail led down the ravine and along the foot of the mountain, through almost impenetrable thickets; then turned sharply to the left up the mountain side. Slowly we followed, now and then losing the track in the thick brush. Suddenly there was a crashing noise a short distance ahead. We rushed forward with all possible speed, and soon arrived at the place where the buck had fallen in the snow; but hearing us coming, he had risen and started on again. We examined the place where he fell and found the snow covered with clotted blood. Expecting to find him at any moment, we moved quickly up the mountain, and after a laborious struggle arrived at the top. There we lost the trail. We tried in vain to find it, and as it was getting late and we were in a strange country, we concluded to give it up; so began to retrace our steps down the mountain.

Night soon overtook us, and not being

able to see the outline of the mountain, we became confused and could not tell which way to go. It was useless to think of camping on the mountain for the night; fire wood could not be procured as the ground was covered with snow, and the weather was bitterly cold. We moved aimlessly about in the darkness to infuse warmth into our benumbed bodies. However, being seasoned hunters and warmly clad, we did not suffer; although, as we afterward learned, the thermometer fell to zero that night. At length the moon came up from behind the mountain and the landscape was flooded with light. Dave uttered an exclamation of joy and pointed to an immense pine tree that stood alone in an open space and that we had taken particular notice of early in the afternoon on account of its great size. Knowing the farm was not far distant, we pushed rapidly on, but had taken only a few steps when a low, snarling sound greeted our ears. Stopping suddenly, we saw 2 glowing eyes shining like balls of fire out of a clump of bushes. We immediately raised our guns and fired. With a savage growl a catamount sprang out of the brush, rolled over and expired almost instantly. We started for home again, taking turns in carrying the big cat. We reached the house at last, and the family were greatly surprised to see the catamount. They had been much alarmed over our absence, and 2 of the boys were on the point of starting in search of us when we arrived.

After dinner we related the details of our deer hunt. The boys were not hunters, but there was a neighbor at the house that evening who was considered one of the best deer hunters in that country. He said that no doubt the buck was lying dead on the mountain, and he would be glad to go with us in search of him in the morning. We arose early and started at daybreak; going directly to the spot where the buck had been wounded. Our new friend, Bill Smith, took the lead and we started on the trail of the wounded deer, which was partially filled with snow that had fallen during the night. When the place was reached where the deer had bled so freely, Bill exclaimed, "That's a dead buck and no mistake." We pressed on, but it was slow work to follow the track, which led through the thickest cover on the mountain and was continually crossed by other trails. We were moving along the top of the mountain through a dense growth of laurel, briars, berry bushes and young cedars. One not acquainted with the habits of deer would say they could not go through such a place, yet our immense buck, with his magnificent antlers went through, apparently with the greatest ease. A buck when penetrating thick places, lowers his head and throws his horns as far back as possible. Thus the points of the prongs do not become

entangled in the brush, but slip through easily. We soon came to a place where a herd of deer had spent the night. It was impossible to follow our buck farther, as the snow was covered with tracks which led in all directions. After an hour's vain search, we gave it up in despair. We had described the buck to Bill, who told us the animal was an old timer, known far and near for his immense size. He had been wounded several times, but was so wary that few hunters were ever fortunate enough to get a shot at him.

It was yet early in the day, and Bill proposed go to a camp of deer hunters farther up the valley and spend a day or 2 hunting with them. When we arrived at the camp we found the men ready to start for the day's hunt. They were all friends of Bill and gave us a hearty welcome, with an invitation to stay as long as we wished. It was a model camp. The cabin was built of heavy logs with a door in front, a small window at one side and a huge stone chimney at the other. The bunks were built along one side, one above the other, and were covered with spruce, a foot in thickness, to serve as mattresses. In the middle of the room stood a long, low table with benches on either side. All the cooking utensils were neatly arranged above the fire place, and in one corner of the room was a rack which contained the guns. A small door opened from the back part of the cabin into the larder, which was a small shed made of logs, through one end of which bubbled a stream of clear, crystal, spring water. In front of the cabin hung a full grown buck and a doe, also 2 wild turkeys; the result of the previous day's hunt.

We went out with the hunters and soon struck a trail along the bottom of the mountain. The bellman, who carried a cow bell fastened by a strap thrown over his shoulder, gave us 20 minutes to reach the nearest crossing. We clambered up the mountain, reached the crossing, and took our position. Soon the faint tinkling of the bell was heard far down the mountain. Deer are curious, and the ringing of the bell sometimes causes them to stand still until the bellman gets close enough for a shot; but they generally trot slowly along ahead of the bellman. I had taken my station about the middle of the crossing and Dave was 50 yards to the right of me. The bell sounded louder and louder, and I knew the game was not far distant. Suddenly there was a sound of wings, and I turned to see a large gobbler alight on a pine within easy range. What a temptation to fire! But, if I should, all our chances for deer would be destroyed, and I would be disgraced in the eyes of the other hunters; so I waved my hand and scared the tempter away.

Scarcely had I done so when there was a slight, crackling noise directly ahead, and I saw a buck and a doe. They were standing in a laurel thicket with only their heads visible and were out of range. As the bellman came nearer they suddenly disappeared. I caught sight of a small patch of gray to my left, but did not fire as the distance was too great and the man below me would get a much better shot. In a few seconds I heard the crack of his rifle. We all gathered, and saw the man who had fired cutting the throat of the buck. On the way down the mountain we jumped a spike buck, which soon disappeared in the brush after having been fired at several times. We had reached the valley and were moving rapidly on toward the camp, when one of the party saw something moving in the brush. We could not see what it was, but followed its movements by the shaking of the bushes. We were soon rewarded by seeing the head of our spike buck appear above the underbrush. He was so far away as to seem out of range. All of the men carried shot guns, but one, who had a 44 rifle. So much of the shooting is done at close range in that sec-

tion, that most deer hunters use shot guns. The man with the rifle raised the sight to 200 yards and pulled the trigger. Instantly the head of the buck disappeared and we knew he had been hit. On reaching the spot we found him dead. We took the two bucks into camp and were soon seated at supper.

That night it rained and the snow became covered with a thick crust, so we could do no more still hunting. We returned to the farm house, remained there several days, shooting small game, and then went home carrying large strings of rabbits, a grouse, and squirrels; but greatly disappointed at not getting our big buck. A few weeks later we received a letter saying our buck had been found dead on the mountain in a dense laurel thicket; so we had the satisfaction of knowing that on our first deer hunt we had killed the famous old buck that had baffled so many hunters. The man who found the buck has the magnificent antlers hung up in his house, and when he shows them to visitors, he tells them how 2 strangers killed the noble old animal that bore them so proudly for many years.

A NATURAL HISTORY SPECIMEN.

One day Bill Nye happened on the sign of the late Major Pond, the lecturer manager, in a window of a New York hotel. He said to a friend who accompanied him: "Here's the man who incites the lecturers. Let's go in and see if we can't induce him to lead a better life."

Entering, Nye removed his hat, ran his hand over the hairless expanse of his head, and, after staring about for a moment, said,

"This is Major Pond, I believe."

"Yes, sir. What can I do for you?" answered the major.

"I want to get a job on the platform," returned Nye.

"Ah—yes," said the major, slowly. "Have you had experience?"

"Well, I've been before the public for a couple of years."

"Yes. May I ask in what capacity?"

"I've been with Barnum. Sat concealed in the bottom of a cabinet and exhibited my head as the largest ostrich egg in captivity."—Argonaut.

RECREATION.

NED NATE.

Some men will toil throughout their lives,
From rise to set of sun,
And take a lay-off only when
Their work on earth is done.

Some work 11 months a year,
From youth till past their prime,
And take their recreation in
The good old summer time.

Some men take Christmas for their rest,
Some take St. Patrick's day,
While some who rest on Sundays
Think theirs the better way.

But I, for one, delight in fun,
I play whene'er I can,
And take my RECREATION on
The monthly instalment plan.

Political Orator: All men are born equal.

Voice in Audience: Then why is it some men get more for their vote than others?—Life.

BUD MOOSE BOGGED.

H. B. BROWN.

When years of maturity have been reached, it is, at times, but natural to hark back to the bygone days and recall some of the events which have made up the sum total of life. Victories we have won serve to cheer by their recalling; at this distance the absurd situations in which on occasion we have been placed become amusing; the regrets which but naturally arise from neglected opportunities have been so tempered by time that their keen edge is lost, and personal reminiscence proves a most satisfactory employment with which to pass cheerfully an otherwise lonely hour.

Thus, here am I, Bud Moose, full of vigor and strength, keen of eye and ear, wonderfully acute of scent, swift and tireless of foot, lying like some unweaned weakling, safely hidden in a dense thicket, and passing the early afternoon with thought of the days when I was young.

I first saw the light of day in Kibby township, up in Franklin county, Maine, and although at times I have wandered far from my native place, never have I found such luxuriant feeding grounds, such tempting pools nor delightful haunts as those of Kibby, and it has always been with the greatest pleasure that I have returned to the old scenes. Of my babyhood my remembrances are not distinct. I have a hazy recollection of being alone what seemed to me much of the time, and of lying in a shady place where nothing came to molest me but a few flies and mosquitoes. On those occasions I suffered more or less from the cold and can clearly recall how nice it was when my mother was with me to snuggle up to her, and get the grateful warmth from her huge body. She spent much time when we were together in dressing my baby coat of hair with her strong, rough tongue. Even to this day I remember with pleasure how warm and comfortable it made my skin feel, and how it imparted new vitality and energy to my whole body.

It was fearfully lonesome when she was away, and the various noises which reached my ears, even then acute to the slightest sound, caused me to tremble with apprehension, though I knew not what made the sounds nor that they portended any harm to me. By nature I was suspicious and wary, and the passing years have added to this trait rather than detracted from it. Once some heavy animal came so near my hiding place that I could plainly hear its soft footsteps, the gentle swish of bushes and low hanging branches as

it passed along, and an occasional sniff as it inhaled the air for a clew to whatever it was hunting. I was in a panic with fear, but fortunately kept motionless, and made no outcry, much as I wanted to summon my mother, were she in the vicinity. The animal passed without discovering me, but I did not move a muscle until Mother came to me, which she did soon afterward, although the wait seemed almost interminable.

My opinion is that all moose youngsters have considerable trouble in getting control of their legs. Such, at least, was my experience. They were together too long to be in proper proportion to my short, light body, and when I stood I felt at a great height above the ground. My joints, though bulging and overgrown, were weak and had an uncontrollable tendency to wobble just when I most desired them to be steady. When trying to stand still it was necessary to keep my feet well apart, and when I moved, my progress was a succession of staggers and totterings. By continued practice, however, I made great improvement and when I began to accompany Mother to the ponds and bogs where we went to escape the flies and in search of the succulent leaves and roots of the water lily, I discovered that were my legs any shorter it would have barred me entirely from this delightful recreation. As it was, I was cautioned not to venture too far. By watching how the others conducted themselves and by guiding myself accordingly I progressed well and was exceedingly proud of my advancement.

Before I was able to accompany her on these daily, delightful rambles, Mother had beguiled many an hour with extended descriptions of my father, of his strength and prowess and of his skill and adroitness. All this I was easily able to believe when I first saw him towering high at my mother's side, and subsequent events proved that she in no degree had overestimated his courage and daring when occasion arose to put them to the test.

One story she related of him always held me spellbound with interest, and I marveled much that one naturally so shy and retreating could show the bravery he then displayed. It appeared that some years before I was born, Father had made a summer trip down into the Spencer stream country and his adventure took place on the bank of that river one moonless, cloudy night, when not a breath of air was stirring. He had been at Fish pond wallowing

after lily pads and roots, and had started for Long Pond bog, to gain which he had to cross Spencer stream. He had just reached the river at a point where the edge of the bank, owing to a long drouth and the resulting lowness of the stream was shoulder high above the water, and was about to plunge in when a slight noise like a piece of wood rapping or scraping against another was heard directly in front of him. The darkness was so intense that he could distinguish nothing, but, true to his usual habits, he refrained from moving until sure his ears had not deceived him. He was standing on the alert when suddenly a dazzling light appeared and was flashed directly into his eyes.

For one instant he stood petrified with amazement; then calling to life his momentarily paralyzed muscles, but with no thought of fleeing from the uncanny light, he made a mighty bound directly toward the gleaming eye. As he jumped he noticed that the light suddenly swerved to one side, and he heard a loud exclamation from the darkness just beyond it. He recognized the voice as that of a man and instantly concluded that the flashing light was one of the many peculiar appliances in man's endless warfare against the other animals. Father struck the water with a loud splash and went in all over with one foot through the bottom of the frail craft in which the men, of whom there proved to have been more than one, had been stealthily paddling down the stream. With a few energetic plunges and kicks he freed himself from the encumbrance on his leg, and lost no time in gaining the other shore. There he paused an instant and listened to the unlucky men who were struggling and shouting to one another in the water, and who were still talking excitedly about their catastrophe when he passed out of hearing. He could remember of striking none of them when he made his mad leap and thinks they escaped with nothing worse than a bad scare.

It has been told to me in later years that some animals suddenly situated facing a strong light as Father was, will stand as if turned to stone and allow those in the boat or canoe to approach within a few yards, but it is safe to say that particular party never again tried to charm a bull moose with nothing more powerful than a bright light. It took courage to make that leap toward the unknown glare, but I am confident that under similar circumstances I should do as my father did, provided, of course, my nerve should prove equal to the occasion.

After joining my father we staid together some time and the season passed for me most delightfully. Of course nearly everything was new and strange, and it is diffi-

cult to conceive the pleasure I derived daily from the many wonderful discoveries I made and the pride I took in each new achievement. Father, notwithstanding his great strength and power, was most considerate toward Mother and me; and with the sense of safety we experienced when he was near we were a most happy family. How well this confidence in his ability was placed an incident well illustrates.

The principal inlet to Horseshoe pond is a stream of considerable size, and for some distance back from the pond proper the water is still and contains some excellent summer feeding places. Mother was at a bunch of lilies in the stream and close to the main shore, while I was in the water at the same side, but nearer the pond. Father had crossed over and was on the strip of land which made down between the pond and the inlet, still nearer the pond than I was. Not being particularly hungry I was simply passing the time in the cooling water with an occasional nibble at some tempting morsel when I noticed what I took to be a log floating slowly toward me. In a few minutes I was attracted again by it and was surprised that with no appreciable breeze stirring and with no current to aid it, the log had lessened the distance between us by half. Mother appeared to have seen nothing to cause apprehension, and, not wishing to give a false alarm, I persuaded myself that I had probably been mistaken in regard to the log's approach and turned my back on it to get it from my mind. Suddenly a sharp, low "hist" reached my ear, and I whirled to find my log right at hand. It was hollowed out and in it were 3 humps which seemed alive, although perfectly motionless. What they were or what their object was in thus approaching me I then had no idea, and as Mother continued her feeding I was at a loss what to do. How relieved I was when I saw my father stalk majestically from the bushes on the bank between the log and the pond. Here was a protector before whom not many could stand. Slowly and noiselessly the log retreated until past my father, when it quickly turned, the beings in it developed more active motions and it glided rapidly out into the pond with Father's huge hulk advancing slowly, but menacingly, along the shore after it. We went back hurriedly into the thicket, and there I was told that the beings were men and what I mistook for a log was a contrivance in which they travel on the water. We concluded that they had been fishing and having seen me had approached until Father's arrival, and his pugnacious attitude had frightened them away. What their object was we were left to conjecture. During the few

days we remained there, we saw them several times, but Father's tactics never failed to cause them to retreat whenever he concluded they were approaching too near. Each day he became more convinced of their cowardice and, in turn, became bolder, until finally the sight or sound of the approaching canoe would cause him to bellow ferociously and prepare to charge should they have the temerity to draw near.

As I continued to gain in strength and ability, so did I begin to feel more independent, to chafe at the restraint put upon me while with my parents, and to long to venture away by myself. In my foolish vanity I believed that I was perfectly able to take care of myself. These feelings became more prominent day by day, until finally an opportunity came to steal away from the family undetected, of which I quickly availed myself. The locality in which we were when I made my break for independence was one little visited by men and through which many moose range during the summer. There were game trails running in all directions, which to a stranger in the country were of great value in getting around by the easiest and most secluded ways. For a few days everything went well. Browse of various kinds was plentiful, and the country was well watered with numerous sparkling little brooks. However, the flies came to me by day in swarms, and I kept looking for a place where I could plunge in and rid myself of them.

The general direction of my travels had been toward the South, and one day I came out on a bog, barren except for a stunted growth of low bushes. On the far side of the bog was a large body of water, and toward it I at once made my way. It proved an extensive pond, although at the shore nearest me the water was very shallow. By wading out, however, I felt assured I could get the depth I desired, and as the pond seemed deserted of all life dangerous to my kind I quickly resolved that here would I take the plunge for which I had been longing. On entering the water I was surprised at the instability of the bottom underneath. This was different from any mud in which I had before waded and, although it let my legs down deep, notwithstanding my feet were expanded to their full width, yet it seemed to cling, and it was with great difficulty that I could make headway. I managed to get out until the mud and water were well up toward my body, when I waited to gain wind and strength for another advance. I had been slowly settling lower into the thick ooze while standing still, and on attempting to continue out I was horrified to discover that I could lift neither foot free from the tenacious mud. How I struggled and strove to liberate my feet from the fettering bottom,

what lunges and plunges I made, and what despair settled on me when, out of breath and thoroughly exhausted, I was forced to admit that it was impossible for me unaided to get in deep enough to swim or to regain the solid shore behind. What a fool I had been to leave the protection and care of my fond parents, and how miserably should I perish did not they or someone come to my assistance. I gave a plaintive call, but no answering sound came to my anxious ears over the forsaken bog. Again and again I called with like result; again and again I struggled frantically for freedom, but my strength was going fast and each effort was more futile than the preceding.

The sun was getting low toward the Western horizon when I was filled with consternation to observe a boat approaching. In it were men and they drew near swiftly, as if they had noticed my plight and were determined to take advantage of it. From babyhood I had been continually taught to avoid man. He, alone, kills for the mere lust of killing. With no young at home in want of food, with his own larder well supplied, and with no necessity for hunting, he often goes forth seeking that which he may slay. It was said there were exceptions among them; that some had instincts and feelings as elevated as those common among ourselves, but that the indictment was true against so many that the only safe course was to shun all, it being impossible to determine until too late in whom the murderous traits were predominant.

With these teachings recurring to me you can imagine with what feelings I saw the men in the boat come up to me. Whew! How they did smell of smoke and what a shiver of fear the odor caused me! They, however, made no move to do me any immediate harm, but after examining me carefully from all sides, took their departure. My relief at seeing them go was but short lived, as they returned soon afterward, and with them came many more in other boats. They had brought ropes which they tied, some around my neck, others about my body. At a signal the cords were tightened and I was pulled toward deeper water. My tongue lolled from my mouth, and my head was on the point of being separated from my neck, when the mud gave way from my leg and I surged forward. I endeavored to regain my feet, but the boats kept advancing and I was pulled along, ignominiously struggling, until deep water was reached. Then I was permitted to swim, but the restraining ropes allowed of no course except to follow the boats. I struck out for shore repeatedly, but immediately the neck ropes tightened, under went my head, and to save myself from drowning I was forced to turn toward my

captors. I soon gave up these attempts and followed whither the boats led. I was extremely weak from my past exertions and it was only after an effort most painful on my part that I was eventually towed alive to land.

On shore my captors, holding the ropes at a distance on either side of me, conducted me to a small hamlet situated at the outlet of the pond. The entire populace of the place turned out to view me, and the remarks they made concerning my figure and appearance were far from complimentary. After they had all looked their fill and discussed me to a disgusting length, I was tied up in a building where there were some other animals imprisoned. These creatures had feet something like mine, but had round horns growing from their heads, and seemed perfectly contented to be where they were. Some dried grass was given me to eat, such as the other animals there had, but I was too exhausted and too nervous over what the future held in store for me, to think of eating, even had they provided forage with which I was familiar.

The next day I was again paraded on the only street of the settlement and my disposal appeared a topic much discussed. In the crowd of garrulous men, women and children, there was one woman with a little black box under her arm. She made the

crowd stand away from me and aimed it at me repeatedly. I could hear a little click, but what nonsense it was or what she thought she was doing was beyond my comprehension.

I was a prisoner among them many days and learned much concerning their ways which the longest life will never efface. They seemed solicitous that I should eat, and brought all kinds of impossible things to tempt my appetite. I did manage to consume enough to sustain life, but how I longed for the fare to which I had been accustomed. One day I was led out and learned that the game commissioners, to whom my captors had written, had decided that I should be set at liberty. I was taken to the shore of the pond near where we had landed that eventful day, the hateful ropes were removed from my neck, one of the men gave me a parting switch with a withe, and I ambled joyfully away.

At first I could with difficulty realize what a happy outcome my escapade had had, but soon I comprehended that I was free. Free to hunt for my parents and endeavor, by my future conduct, to atone for my past misdemeanors. Free to breathe the clean, untainted air of the forest. Free to live as it was intended I should. A weak, half starved, most forlorn little wretch, but free!

THE OWLET'S FLIGHT.

S. H. M.

An owlet sat in a towering pine
And wisely gazed around;
The night lay darkly on the wood,
Earth slept without a sound.

"The moon and I alone are out,"
He said, and heaved a sigh.
His gaze intent was fixed upon
The crescent hung on high.

"I wonder," and his eyes grew big,
"If it really is green cheese,
Or if it is a world like this
With leafy trees like these."

"I plainly see the man up there,
He's looking straight at me.
He's all alone like me to-night;
Where can the maiden be?"

"When last the moon was big and round
She sat with tresses fair,
And smiled upon the world beneath;
How did she get up there?"

"Too wit! too whoo!" in breathless voice
The little owlet screamed
As he lighted on fair Luna's horn.
Fair Luna only beamed.

"Who, who are you?" the owlet asked;
"Where is the maiden fair
Who often waves her golden locks
Till they shimmer in the air?"

"Where go you when at early dawn
You sink behind the West?
I sleep within a hollow tree;
Where do you take your rest?"

"Some nights you hide your beaming face
And then I look and call.
Oh, those indeed are gloomy nights,
The darkness is like a pall."

In vain the owlet questions asked,
The moon made no reply;
Day dawned and the owlet fell asleep
With the moon in the morning sky.

A SHARP FOREBODING.

C. H. FURLONG.

Alarming depletion in their ranks had prompted the wise and cunning old leaders of the various animal species to gather under the protecting branches of the big forest trees. The time was come to make a resumé of Man's doings for the season. Sons and daughters had been slain, brothers, sisters and other relatives had fallen victims to the trapper, the city sportsman and the idle country boy. Appalling slaughter was reported among the feathered tribes. New tracks had been beaten by Man's foot in the great forest realms; he had penetrated into what were hitherto considered safe and inaccessible retreats.

"Only yesterday my eldest son, a fine, promising lad, with muscles as firm as steel and supple as the willow branch, was laid low in death as he was peacefully browsing. He died before I could catch his last plaintive groan," mournfully remarked Monarch Moose to the assembled cohorts.

"Last week one of those little pellets used by Man to exterminate us crashed through my mother's brain, and with rage and sorrow struggling for the mastery in my breast, I was compelled to flee, lest I, too, fall at the next bark," was the sad comment of a grizzly cub.

"None of my family is left at all," cried Father Rabbit; "fine shot has carried them all off, in some instances 2 and 3 at a time being killed."

"I've given Man a run for his money," proudly proclaimed Furtive Fox, "but with all my cunning and wily tricks, and I think everyone here will admit I've turned a few pretty ones in my day, I couldn't save my wife's life this season. I saw her pelt, I believe that is what Man calls our coats, hanging from a hunter's cabin door a few nights ago. I couldn't repress my emotions, and would have wept my fill but for the growl of a prowling hound reaching my ears."

"Your sorrow is a hard one to bear," said the bereaved Monarch in a condoling tone. "It's dead tough, as I heard a hunter say in throwing away a piece of venison the other day."

"Your Honor always had a pleasant way of interspersing a bit of humor to relieve the lugubrious," jollied the fox.

"He's going to ask for something," snapped Caustic Catamount.

"You mistake me, brother," suavely replied the fox in an effort to be conciliatory, "for you know one of my greatest faults is an overappreciation of the humorous. Remember how I laughed when we found that fat old rabbit in the trap? He looked so much like an apoplectic shoat I had pinched

the night before that the comparison overcame my sense of propriety."

"Never fine at any time," retorted Catamount.

"I can see where Mr. Fox gets his if this repartee keeps up," cautiously whispered Prickly Porcupine in Red Squirrel's ear.

"Now you 2 have had enough of this," admonished the Monarch as he assumed a more stately and dignified air, preliminary to taking up the order of business.

"It is the sole purpose of this gathering," he resumed, "to inquire into and seek a satisfactory explanation of the terrible depletions in our ranks within the past few years. Grizzly has the floor. After that the first one who attracts my attention will be honored with permission to harangue. Father Fox is limited to 5 minutes, for he is too garrulous and fond of his wit. Grizzly will now address us in his characteristically forcible and pointed style."

With swaying motion of his bullet-scarred head, and centering his penetrating eyes from time to time on each member of the assemblage, Grizzly began:

"This question of the extermination of my own and the families of my brethren has been occupying my thoughts for——"

"Your humble pardon, Monarch, but if Grizzly will take a pointer," rudely interrupted Fox, "I beg to suggest that——"

"Down with him!" cried the assemblage in thundering chorus.

Grizzly bent over and gave Father Fox a belt in the snout. Father Fox attempted to apologize, but even that privilege was denied him, so indignant were all at his breaking into Grizzly's well worded introduction. He nursed a swollen jaw during the rest of Grizzly's address, while Catamount twitted him in a cautious but none the less tantalizing undertone.

"As I said before this uncalled for interruption, much of my time has been given to a consideration of the means which have brought about such a heart-rending slaughter in our midst, and by the bristly tail of my grandfather I think I've solved the problem."

"If so, it will be a worthy testimonial to your already envied acumen," commented the Monarch with a faint touch of deference toward the formidable roamer of forest and mountain.

Grizzly bowed his head in grave acknowledgment of the Monarch's agreeable compliment and became just a bit chesty.

"The Old Un's a peach at slinging the salve, isn't he?" remarked Porcupine to Squirrel.

"And the solution is?" chimed in Wo., Catamount and Badger all together.

"That smokeless powder is the cause of our undoing," growled Grizzly, with a dramatic swing of his left paw that threatened disastrous contact with Doe's shapely head.

"Smokeless powder? What the d——"

"One bushel of the choicest leaves you can gather in your jurisdiction is the fine imposed on you for profanity uttered in our presence," pronounced the Monarch, his angry eyes darting reproach at the impulsive offender.

"I can see my youngsters wearing out their fall allowance of clothing to satisfy that stunt," chuckled Imperturbable Porcupine.

"Yes, and I can see portions of your carcass in the process of digestion in Wolf's stomach if the fine isn't forthcoming," was the comforting retort of Squirrel.

"It's smokeless powder and nothing else," resumed Grizzly, when the surprise which his discovery caused had subsided sufficiently to allow the assemblage to listen with its wonted unanimity of attention.

"To convince you all that I'm right in my deductions, I will review the evolution of the sporting arm, which I have learned is the name of the weapon used by Man in gratifying his thirst for blood. I will make it as brief as possible."

"If you spoke until Doomsday our interest would remain at fever heat," said the Fox, seeing a diplomatic opening by which to regain favor in Grizzly's eye.

"Mr. Slick is throwing a bunch of con again. We ought to appoint him minister plenipotentiary to negotiate terms of peace with Man," was Porcupine's envious comment.

"To continue," said Grizzly, "I wish to explain that much I am going to tell you was handed down by my ancestors, my great uncle in particular. He was a mighty scientist, having an investigating turn of mind from his early youth. His relatives, farther back than I can call to mind, had some great experiences with the French *couriers des bois* and the trappers of the Hudson Bay company. They were relentless men, strong of limb, steady of aim and devilishly accurate with their damned long barreled guns. Those guns were muzzle loaders; that is, the powder was poured from a flask into the muzzle of the gun. Black powder was used exclusively in those days and even up to quite recent times. It was of a much coarser quality and not so sure of fire as it is to-day. A pinch of

powder was placed in a pan at one side of the lock, connecting with a tube entering the barrel at the breach at a point where the powder lay. The gun's hammer contained a flint, which, striking a piece of steel connected with the powder pan, emitted sparks and ignited the powder. Then the bullet flew out, but not with half the force or range of later day black powder guns.

"Later came the percussion cap gun. Then the pin-fire weapon, which used a cartridge similar to those which to-day end the lives of our brethren. These old time smooth bore guns were sufficiently effective to kill our largest and most formidable people. Just think, though, what a cinch our ancestors had compared to what we have to cope with. It took more than a minute to reload one of those old guns. In that time one of our forefathers could give a trapper the merry ha ha and even contemplate a flank movement destructive alike of the pursuer's mental equilibrium and bodily solidity. Even if wounded, our forefathers had time to make themselves scarce, unless they desired to mix things.

"But powder and ball were new to our ancestors," continued Grizzly, "and it took time for them to get next. After many years the rim fire breach loader came out. Then the slaughter increased. Not satisfied with this, inventive Man (those 2 legged beasts must be very devils with their brains) brought out a repeating rifle, using various cartridges of all shapes and sizes. Up to a few years ago nothing new was doing in the gun line. All of a sudden some crank stumbled on the smokeless game to make more convenient and certain our slaughter.

"My brethren, I fear we are undone. There is no escape for us. This new discovery gives increased range, makes no smoke, scarcely any noise, and steel jacketed bullets with a portion of the lead exposed are used. They smash like a boulder hurled from the mountain top. Now having told you all this, who present can foresee the future?"

"I can," yelled out Porcupine.

"What is it?" gravely asked the Monarch.

"It's all to the mustard for us," replied the assembly's joyous spirit.

This bit of levity so enraged the others that a riot ensued. Half an hour after Wolf came around and cleaned up the remains.

"If all the meetings break up this way it'll be a good thing for me, now that food is somewhat scarce," he said to himself.

Willie—Pa, if a warship is called "she" why isn't it a woman-of-war?

Father—It's your bed time, Willie.—Boston Post.

A DAY IN THE ROCKIES.

BRUCE LEMMON.

According to previous arrangement, the Doctor and I arose at 4. We put on our oldest clothes and our heaviest shoes; and went to town for breakfast. The Doctor carried his long range .30-30, with its magazine full; I carried a .25, with magazine and a pocket full of cartridges. I also carried a field glass. At the restaurant we found our third partner, Ed B., a miner. After breakfast we possessed ourselves of 3 horses, mounted them, and in high spirits left town at 5.20 a. m.

Our destination was the summit of Mount Shaveno; our purpose was the pleasure that lies in mountain climbing. Mount Shaveno lies in the Sangre de Christi range, some 10 miles West of Salida, Colorado and is more than 100 feet higher than Pike's Peak. It is not to be compared with Pike's Peak for climbing purposes. Pike's Peak has an established route to its summit, a good road all the way, and, moreover, is not excessively steep. Mount Shaveno is a wilderness on every side, has no road whatever, is very steep, and has, to cap it, 2 nearly perpendicular miles of loose granite boulders.

At the foothills we struck abruptly off from the road and entered the timber by a cow trail. We followed some distance up a creek, made the horses jump a fence, crossed the creek, entered farther into the pine and cedar brush, climbed a long, low, grassy ridge, galloped its length and came down again into the dry bed of another creek that we followed up some 2 miles and again rode out on a brushy ridge. Always our faces were toward the great, massive mountain towering above us, notwithstanding a great deal of zigzagging and cross windings.

As we traveled lengthwise of the ridge, Ed first, the Doctor second and I in the rear, the Doctor said excitedly:

"Stop! Get down quick!" Following his eyes I saw, on the crest of the next ridge to our left, 200 yards away, a deer, facing us, watching us. The Doctor dropped on one knee, raised his peep sights, and fired. The deer jumped and disappeared beyond the ridge. We gave chase, found abundant blood where he had stood, and carefully scrutinized the gulch below. Again we saw him, but he was at once gone. He was walking slowly. I saw him again, but had no time to shoot. Ed and I started off on his trail, like 2 dogs, while the Doctor watched. We trailed that deer 2 miles across ridges, through gulches, and he, as we saw from his trail, was bleeding and

moving slowly all the way. Once we scared a gray fox. After the 2 miles we gave up the chase and went back to the horses. Two hours lost, and nothing to show for it.

We picked our way on up to timber line, drank long and deep from a clear, icy brook at our side and pushed on up. To the right of Shaveno is another peak, and between the 2 is a low saddle, or ridge, at the head of a gulch which divides the 2 mountains from summit to base and which we had been following. We crossed a transverse ridge, and beheld one of the most beautiful scenes I ever saw. Directly in front of us was a deep, clear lake, 600 yards long, and about 200 wide, perfectly walled in on 3 sides. Mount Shaveno's precipitous side rises abruptly from the water on the left; her sister mountain leaves 100 yards of lake shore on the right, then rises as sharply; while straight ahead is another precipice of jagged crags and numerous miniature peaks, surmounted by rounded buttes. The small basin about the lake is covered with flowers, a sort of dandelion with rich purple leaves, and others, about 6 inches high, resembling sunflowers. There was but one way out of the basin for us. The buttes at the upper end of the lake were between us and the saddle, therefore we had to scale them. It was the most difficult piece of climbing I have ever done. The angle is 80 or 85 degrees; the footholds are scarce and small. We rested half a dozen times on our way up and ate snow from a drift at our side. At one o'clock we reached the crest of the saddle and were at least 12,000 feet high. We could barely see Salida, far down the valley. On the other side is another valley, small and completely shut in by high mountains. To the West beyond this small basin, as far as the eye can reach, rise the summits of innumerable peaks. We found a spring of icy water and by it ate our sandwiches, sheltering ourselves on the sunny side of a large boulder, for a cold gale was blowing.

Shaveno still loomed above us. The saddle runs North and South, at its Southern end intersecting another small ridge; and at the Eastern extremity of this smaller one is the highest peak of Shaveno, whither we were bound. We climbed up, not over rocks only, but granite boulders, 20 feet through. As we looked back we saw 5 ground hogs playing in the basin below us. We also saw several fresh sheep tracks and some wool on the sharp corner of a rock.

Finally we reached the smaller ridge, and struck off to our left, toward the highest point of Shaveno. We staid within touch of each other to lessen the danger of rock slides. Several times I grew dizzy an effect of the rare air, but I said nothing of it until the Doctor admitted that he, too, was dizzy. It was cold, and the wind was blowing a hurricane. We sat down on a sheltered rock to rest, and at that instant Ed said in a tremulous voice, "Hush! Lie low!" and pointed out to us a mountain sheep, the first any of us had ever seen. It was a beautiful sight. The sheep was about 600 yards away, on a large boulder, and directly between us and the sky. We saw merely his clear silhouette. We watched the magnificent animal as he turned and walked directly toward us. His head was held high in the air, and he picked his way over the rocks with wonderful nicety, never slipping, never misstepping. He traveled considerably faster than a man could have walked over the boulders. When about 200 yards from us he turned, walked across the crest of the mountain, and disappeared. That sheep probably does not know to this day how nearly he came to walking right into the 3 human beings who were visiting him at his home on old Shaveno.

We climbed on toward the summit which was then **not** far away. At one time a flock of large, beautiful birds flew almost over our heads. They were about half as large again as full grown pigeons, were white marked with black, their wings were long and made a whirring noise, and as they flew they uttered unmusical squawks. There were at least 20 of them. They told me afterward that these were the rare ptarmigan.

A few minutes more and we reached the summit. The view was superb, indescribable! The most prosaic nature would have been thrilled and awed. On 3 sides of us were mountains, as far into the blue distance as we could see. To our East lay the Salida valley, 15 miles long, and at its farther end a red speck, Salida. West of Shaveno, far below us, was a small, circular, marshy basin. With a good jump we could have bounded down the mountain side nearly to it, some 2 miles.

It was so fearfully cold that we began the descent at once, without writing any poetry on the summit. In going down, we ignored all saddles and gentle slopes, and took directly down for the horses. We had

2 miles, without a break, of loose granite to climb down, and the average slant must have been at least 45 degrees. We soon became widely separated, and before I was half down, no living thing, save a soaring eagle was in my sight. On all that mountain side, alone, I felt minute. I often paused to look and wonder and try to appreciate. By using hands and feet I made good time. I soon heard a brook running under the rocks beneath me, and following the sound of it, I saw it emerge. On one of its banks there was a border of about 300 feet of grass. I clambered down to this green streak, feet and hands as brakes. Whenever I grew tired and thirsty, I lay on the rocks and drank from the icy brook. After awhile the brook again sank, and forced me to take to the rocks. When nearly down I came suddenly to a jumping-off place. I crept up and looked over, and, lo! I was on the ledge overhanging the beautiful, deep, clear lake we had discovered in the morning. I was afraid the ledge might break, so I did not linger. I climbed around the upper end of the lake, descended a short distance, and was down out of the rocks.

I followed the basin on down and found Ed, just arrived. He was bathing a skinned arm and side, but was thankful he was able to do the bathing. In coming down he had loosened a rock above him. It was about the size of a foundation stone, and it loosened several others. Ed saw them coming straight at him. He jumped, and landed, he said, about 30 feet farther down. In catching himself he sprained his wrist and bruised his side.

We walked on down to the horses, about half a mile away, and saddled them. The Doctor then appeared, and we took to the trail down through the timber. Once my broncho became somewhat excited because the dog ran between his legs. He began to buck with great vigor, to run down hill, and to scrape against all convenient pine trees. The other men laughed heartily, but from where I was I could not see the joke. When we reached the trail of the wounded deer we stopped and followed it. The Doctor found it, dead, on a ridge not 100 yards away, whither it must have returned during the day. Its meat was unfit for use, hence, regretfully, we left it.

Our ride to town was otherwise uneventful. We reached home at 10.30 p. m. Tired?

Stranger—Why do you let that child cry so. He's howling all the time.

Bridget—Shure, sir, it's the only way I kin kape him still.—Exchange.

ADVENTURE WITH A COYOTE.

HOWARD CARL.

I had known John from boyhood, had gone to school with him, and had hunted with him many times. He was a good shot, but sometimes missed, as do some other good shots.

He finally emigrated to California. One might have supposed from the record he had on rabbits that he would have had no trouble shooting coyotes. Just how much trouble he had, I learned a few years later when I visited him. His wife told me the following story:

"The coyotes had been bothering us greatly, scaring and catching our chickens, and we would hear them howling around nearly every night. John got in the habit of looking out of the window the first thing on rising to see if there were any of the animals in the neighborhood.

"One morning he looked out just in time to see one trot along the back fence and disappear behind the barn. Without stopping for ceremony, or clothes either, John rushed out the back door, grabbed his rifle, which was in the tank house near, and hurried to the barn, expecting to get a shot as the coyote came around the corner. However, it had been too quick for him and was trotting along the foot of the hill about 100 yards away. John threw the rifle to his shoulder and tried to take aim. The coyote stopped before John could fire and then started on again. This happened twice. Finally John rested the rifle over the top of a post and just as the coyote was going by his line of sight, pulled the trigger.

"He hit him, but so far back that the poor animal sat down and began to howl. John turned his attention to another coyote which he had just seen making for the hills. He hurriedly turned up his Lyman sight to the 200 mark, but the coyote was so unsportsmanlike as to get behind a tree and make off with that completely covering his retreat.

"John then started down to finish the brute he had wounded, intending to shoot it in the head. He got within 50 yards when the animal jumped up and ran. John

fired, saw the dirt fly on the opposite side of the coyote and, as it dropped at the report, thought the bullet had gone clear through the mark. He walked a little closer, took aim at the coyote's head and fired. Again the beast jumped and ran. A third time John fired and a third time the coyote fell. Determined to make a sure thing of it, John took aim at its head, intending to blow its brains out. He could not hold steady, but fired as the end sight in its movements wobbled by the coyote's head. Up jumped the beast once more, and click went the hammer. The magazine was empty.

"John came running back to the house, and as he was barefooted and was running through stubble, he touched the ground as lightly as possible; one would have thought him a ballet dancer; an inference borne out by the fantastic flutter of his nightgown about his legs. When he got to the house I gave him his slippers. He hurriedly grabbed his remaining cartridges and ran back. The coyote had obligingly waited for him, but when John drew near it started off. John fired and down it dropped; he fired once more and the coyote again made off. John had thought he could shoot a little, but as he ran back to the house the second time, he had about lost confidence in himself.

"He hurriedly seized his loading tools, loaded 2 cartridges and started back, determined to end the massacre. When he got close to the coyote it wobbled to its feet, John stopped and, aiming low behind the shoulder, fired and dropped the brute to stay.

"John didn't feel much elated but, nevertheless, he examined his prize. Besides the first and the last 2 hits, he found 2 bullet holes through one ear, 3 through the other and 2 long lines across the top of the animal's head.

"A few hours later, on picking up his rifle he noticed that the Lyman sight was elevated for 200 yards. When he goes hunting now he always hears a familiar voice saying, 'Don't forget to elevate your sights, John.'"

Ascum—If "brethren" is a synonym for "brothers," why not "sistern" for "sisters?"

Henpeck—Nonsense. I've often heard of a cistern that would dry up occasionally.—Catholic Standard.

FROM THE GAME FIELDS.

The man who quits when he gets enough, with plenty of game still in sight, is a real sportsman.

GROUSE SNARERS CAUGHT.

A. C. Ferguson and Stephen Horton, of West Sandlake, New York, went after some grouse snarers in October last and caught them. The detectives found several brush fences which the snarers had built and in which they had concealed numerous wire snares set with springs. Ferguson and Horton camped by one of these fences over night and just at daylight they caught Henry Wagner, of Alps, N. Y., in the act of taking a ruffed grouse from one of the snares. He had in his possession another grouse and a rabbit which he had taken from other snares. He was waltzed into the justice's office and fined \$88.95, which he paid. It doubtless took the proceeds of many weary days of trapping to clear the justice's docket, and it is hoped Henry may find some more profitable occupation. Meantime his name goes down in the game hog book as number 921.

Frank Cipperly and Charles Acknour cooperated with Ferguson and Horton in running this grouse snarer to cover. In reporting the case to me Mr. Ferguson says:

Wagner had about 5 miles of grouse fence. There were 2 more birds in his fence when we caught him, but as he came from the direction opposite that which we expected he had not been to the other birds, so saved himself a few dollars. You cannot hit these fellows too hard. I can go on Sandlake mountains and in one day collect 5 pounds of snare wire, no one wire more than 15 inches long. Our club, of 200 members, is trying to drive these snarers out of business, and we will eventually succeed if we have to pay the expenses out of our own pockets. We have to give them full doses or it does not count. Last Saturday I was on the farm of a woman whom we arrested and fined \$44 last fall, and she now has 4 to 5 miles of fence on her place. She says she is considerably ahead of the game, at that. I am in hope of landing her soon. They are all as sly as foxes and as cunning as coons. We have to study their respective habits before we can catch them in the act. For instance, some look at their snares about midnight, others at 4 o'clock a. m., while others go just at twilight. Then, again, others will let birds lie on cool ground a week, until they go to market, as they run no risk of our finding birds at their houses provided a search is made. They also show their cunning in carrying birds to market. I have known birds carried under a load of charcoal; in false seats; in sacks; in butter jars, with an inch of butter over top; in the lining

of an overcoat; in a new flour barrel headed up; under potatoes and apples; and in many other ways.

Arthur C. Ferguson, West Sandlake, N. Y.

COURAGEOUS WARDEN VINDICATED.

I have been doing some hard work in Ashtabula county. I am a deputy State game warden. I became interested in birds and game by reading RECREATION, which I consider the most valuable journal of its kind. I try to enforce the laws regardless of who the violators may be. I have at times taken some of my friends into court and made them suffer. We have a comprehensive law on song and insectivorous birds, covering every species except crows, English sparrows, etc. Last winter I received instructions from our chief to go after the milliners, and I brought cases against 10 different parties. The movement was not popular here, and the press quite generally roasted me. However, I knew my rights and maintained them. At the present time there is not an establishment in Ashtabula county handling illegal plumage or birds; and I have the satisfaction of knowing I am right. The public and the press are now coming our way.

If every warden would, in a straightforward way, enforce the laws it would be a grand thing; but too many either use the office for their own ends or for the benefit of their friends. I enclose a clipping from one of our county papers which explains the case. The editor turned himself loose last winter when I caused the arrest of one of his town milliners in whose stock I found a lot of birds. I asked him to go down and look at the stock. The clipping is the result of his visit to the store. I wish everyone could read RECREATION. It is one of the best educators of the young, and places an older person in such a light that if he has any manhood he can not help trying to be good.

G. H. Ray, Rock Creek, Ohio.

The clipping Mr. Ray sends is as follows:

Last winter when Game Warden Ray, acting under instructions of the State warden, caused one of his deputies to make a raid on local millinery stores and confiscate, for evidence only, such birds as were protected by law and whose sale was contrary to the statutes, this official was the subject of some severe criticism by the people and the press. Mr. Ray is not the mean man that his position makes him appear. This morning he found it necessary to investigate a Main street millinery store. No prohibited plumage was found on the goods

displayed, but when the reserve stock was inspected over 40 birds were found. Mr. Ray requested them to be burned and the owner promptly complied.

I have heard from several other sources of the good work which Warden Ray is doing in his district, and heartily commend him for it.—EDITOR.

NEW IDEA FOR CAMPERS.

732,733. Combined Cot and Tent. Ira L. Gleason, Hutchinson, Minn. Filed June 24, 1902. Serial No. 112,973. (No model.)

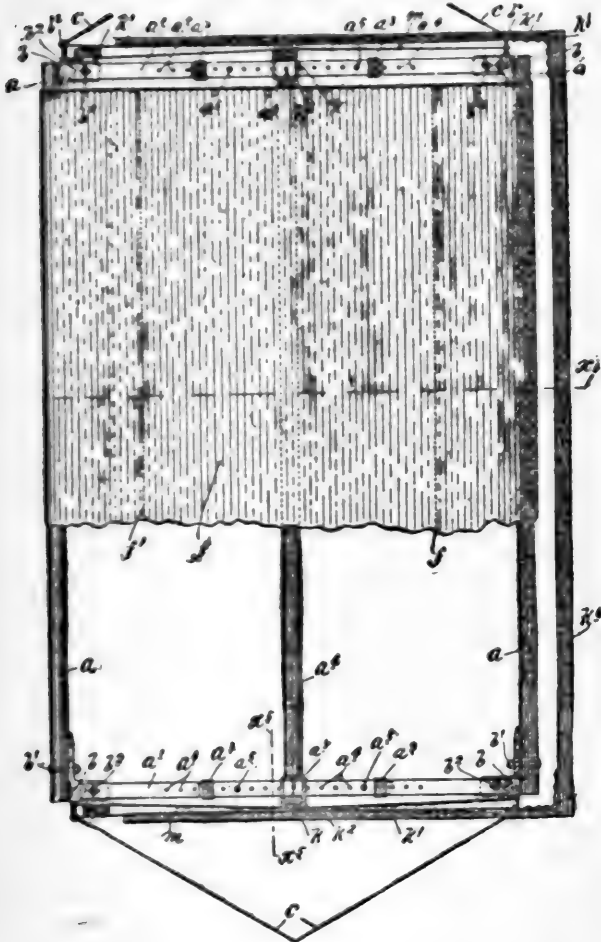

Claim.—1. The combination with the cot frame having adjustable end rails, of a cot canvas *f* formed double and with longitudinal seams *f'*, and the detachable center rail *a''*, insertible through the central fold of the canvas and detachably securable at its ends to the rails of said cot frame.

2. The combination with a cot frame or base support for a tent, of supporting ropes extending transversely across the head and foot of said cot or support; and a tent involving a tent cover or canvas, and tent poles, the side members of which poles work adjustably on the said supporting ropes.

WHERE THE WOLF WAS CAUGHT.

JEANNETTA ZIMMERMAN.

We had just laid old Uncle Matt in his last resting place, and as we rode away Art proposed as a fitting finale for Uncle Matt's burial that we call the hounds and have a big wolf hunt. The old darkey had never been happier than when we had allowed him to follow the hounds with us.

The snow was melting and everything was perfect for a chase when we met that afternoon at Deep Creek farm. From there we went 3 or 4 miles to where wolves had been seen and heard in an extensive slough, consisting of small trees and dense brush. The hounds were running, but not on a trail, when out from the opposite side of the brush jumped a big wolf and headed for the long hill to the South. He left considerable territory behind him before we could get the hounds bunched and Old Trim on the track. As soon as he began to tongue the others followed. The wolf made for a road, then through an orchard to the railroad track. He walked leisurely up the track, every now and then looking back to see how near the dogs were.

Suddenly he made a dash to the right over an upland prairie. The younger hounds were thrown off and kept on up the track, but Trim never left the trail, and soon over the prairie went the wolf with all the hounds in hot pursuit. Trim made a good leader for any hound chorus. Especially fine was he with the wolf in view, and the distance between becoming shorter. The wolf made for O'Brien's cattle lots, evidently expecting to throw the hounds there. Then we knew we were up against the same wolf that a few weeks previous had escaped by running in among O'Brien's cattle after we had given him a hard and long chase. This time he was doomed to disappointment as the cattle had been moved to another ranch. When he came to the feed lot and didn't see a hoof he seemed to lose spirits. He looked around dejectedly and took a path leading to the church yard, the hounds close behind. Right on the newly made grave of Uncle Matt the wolf stopped, faced about, and showed fight. The hounds rushed in, and by dint of numbers bore the old fellow down and killed him.

FINED FOR TRAPPING BIRDS.

Dr. Joseph Kalbfus, Secretary of the State Game Commission, is making it expensive sport to violate the game laws, and a few more captures of the sort he made here yesterday will go far toward inspiring respect for the laws protecting insect-eating and song-birds.

Charles Brunhouse, a York shoe dealer, who has been making a specialty of catching grosbeaks, better known as redbirds or cornercrackers, with a clever contrivance of wire and silk threads baited with a live redbird as a decoy to lead

others into the trap, was neatly caught, with the goods on him, yesterday by Dr. Kalbfus and Game Warden Berrier, of Harrisburg, and heavily fined by Justice S. N. Eminger, of this place.

Recently Dr. Kalbfus heard of Brunhouse selling the birds and bought several from him at York. Warden Berrier was then put on the case. Coming to Mechanicsburg last Thursday evening Berrier made the acquaintance of Brunhouse and on Friday morning the 2 took a drive to the South in search of game. During the time they were together in the country Berrier witnessed the capture of 6 birds in Brunhouse's trap. When they drove back to town in the afternoon they had a total of 26 birds. Dr. Kalbfus was in town awaiting them with a warrant charging Brunhouse with violating the Act of Assembly of June 4, 1897, protecting insectivorous and song birds. He placed the man under arrest at once.

Brunhouse was taken before Justice Eminger for a hearing, during which he appealed to Berrier for help, and was chagrined to learn that gentleman's real business. On the evidence given, the justice imposed a fine of \$10 for each of the 26 birds found in Brunhouse's possession, and the costs, the total amounting to \$263. Brunhouse refused to pay, saying he would appeal the case. He was then placed under \$550 bail, which he furnished.

The captured birds were taken to the yard back of the Squire's office and all but 5 were released. The remainder were taken to Harrisburg.

During the past week Dr. Kalbfus has done considerable effective work in different parts of the State. Monday, at Lilly, Cambria county, he secured the conviction of 2 miners who had beaten down the nests of orioles and killed the young birds. Being unable to pay fines of \$50 the miners went to jail for 50 days. At Woodbury, Bedford county, a man who amused himself shooting swallows paid a fine of \$30. Dr. Kalbfus will be busy again next week.—Pennsylvania Paper.

Brunhouse will, no doubt, have to pay his fine eventually. He will probably decide to do so without paying out other good money to some lawyer to defend him. When Dr. Kalbfus gets after a law breaker, his name might just as well be Dennis as Brunhouse, or anything else. Brunhouse goes down in the game hog register as No. 922.

RANGE OF THE GLACIER BEAR.

At the foot of Mount St. Elias and reaching from the head of Disenchantment bay to the Copper river delta, a distance of over 150 miles, is the great Malsipena glacier. At one or 2 points it breaks into the Pacific ocean. The glacier is gradually receding inland and has left a strip of land along the shore varying from a few yards to 15 miles in width. As a rule this strip of land slopes gently back from the sea. The formation is sandstone and this section is known as sand dunes. It has a scattered and stunted growth of spruce timber with plenty of grass and small berries.

As soon as the snow goes off the dunes in spring and during the summer, this strip of land is the home of the glacier, or blue, bear. At intervals rapid rivers find their way under the glaciers and across this strip of land to the sea. They are difficult and dangerous to cross. The boulders in them are covered with fine glacial mud, slippery

as soft soap, the rivers are swift, cold and usually about 4 feet deep. Outfit required: Folding canvas canoe, small bore smokeless rifle, carbine style; small field glasses, compass, ice creepers, etc.

Land at Kayak island from steamer, cross over to Auktalee sand spit, 3½ miles, on the mainland, thence 25 miles down the coast past Cape Suckling to the Indian camp known as the Seal House. Go into camp there, and you will have one or 2 glacier bears within 2 weeks. Bears will be found feeding on the grass and berries on the dunes between the glaciers and the sea. It would be advisable to secure the services of an Indian guide, or of a white man who is familiar with the country.

L. L. Bales, Seattle, Wash.

EIGHTY FOXES CAUGHT WITH TERRIER.

I read in September RECREATION a note from F. W. Stapleton in reply to an article published 7 or 8 months ago, signed by me, and which was written over 5 years ago. That was before the law was enacted in this State which prohibits the sale of game, and at that time 6 weeks more were allowed to hunting than are at present.

I agree with Mr. Stapleton that game is more plentiful now than for years past; but at the time my letter to RECREATION was written game was scarcer than I ever knew it to be.

Is it strange Mr. Stapleton never heard of a fox terrier being used in hunting foxes? Every hunter learns something new every year he hunts, or every time he reads RECREATION.

It is never too late to learn, and here is Mr. Stapleton's chance.

In the spring of 1897 George Shaw did capture over 80 foxes with a fox terrier. Every farmer in that region who knew of a fox burrow sent word to Mr. Shaw. His fox terrier would go into the hole and drive out both old and young foxes. They would be either shot or caught, though most of them were caught alive. Mr. Shaw sold over 50 live foxes that year, shipping them to the Southern States.

I should be glad to make an appointment with Mr. Stapleton next spring, so that he may see a fox terrier drive out foxes.

Dr. S. B. Keith, Palmer, Mass.

A BOY'S LUCK.

We had gone into the big woods of Maine for our annual hunt, and had taken up our quarters at one of the many comfortable log camps of that country. Early on the morning after our arrival the guide and I started out to provide venison for the camp. We crossed the lake in the canoe, and took a short cut through the forest to another lake about 2 miles beyond. We saw nothing on the way out,

but on the return trip, as we came along an old rocky road, we caught a glimpse of a big buck; but he had already winded us and was making long leaps through a windfall, so I did not shoot at him.

Early the next morning we started out on another trail. We had gone about ½ mile from camp when a young spike buck sprang up, made a few jumps, and, like Lot's wife, stopped to look back. That was where he made a mistake. The next instant a bullet from my rifle landed just back of his shoulder, and making 2 or 3 more leaps, he went down in a bunch. The guide dressed him and carried him to camp. When I tell you I am but 11 years old, you can imagine what a flurry of excitement there was, and what a shower of congratulations descended on me. That was the first deer of the season killed at that camp, though several old hunters had been putting in full time in the woods for 3 or 4 days before I arrived.

R. Goldschmidt, Jr., Augusta, Ga.

MONTANA IN DISGRACE.

I am a constant reader of your splendid magazine and much admire the stand you take against the people you have very properly named game hogs. The last session of Montana's Legislature passed a law that allowed the shooting of chickens on the 15th of August, instead of the 1st of September, as has been the law here for many years. In my opinion such a law is much at fault. Birds are not able to take care of themselves at such an early age, and, consequently, men with but little of the true sportsman's instinct can ruthlessly slaughter many birds without giving them the least chance for their lives. I should like to learn your opinion on that subject.

E. M. R., Butte, Montana.

That clause in your game law is a long step backward. Nearly all the States in the Union are gradually shortening the open seasons for killing game and at the same time are placing limits on the number of birds or animals which each man may kill in a day or a season. Some States which provided bag limits a few years ago have recently reduced them. In spite of all such provisions, game of all kinds is constantly decreasing in numbers everywhere, and it is indeed unfortunate that Montana should have gone backward in the matter of protecting her prairie chickens.—EDITOR.

IT WAS EXCESSIVE.

In a few hours' shooting City Marshal Smith and the Hon. John Butt, of Clarksdale, bagged over 60 teal ducks, Mr. Butt getting 42 out of the 51 shots.—Memphis, Miss., News.

Replying to my inquiry as to the truth of the foregoing report, Mr. Butt says:

But that I fear you would consider me a

game hog I should enter a plea of guilty to the charge. I trust I can with safety, however, state that the shooting was the best I have ever seen.

J. S. Butt, Clarksdale, Miss.

The inference is, therefore, that the statement quoted above is correct. While your killing is not nearly so excessive as that of many others I have to report, yet it was excessive. I take it for granted that you and your friend are gentlemen, and as such you should have been satisfied with 15 or 20 ducks each. This is about the limit among all high class sportsmen of today. It is true that 2 States in the Union legally authorize the killing of a larger number, but that does not prove that it is right. I know plenty of men in the 2 States referred to who quit when they get 10 or a dozen, even though they have chances to kill many more; and I trust that you and Mr. Smith may hereafter be satisfied when you get enough.—EDITOR.

GAME NOTES.

735,314. Decoy. Robert H. Syms, New York, N. Y. Filed Oct. 28, 1901. Serial No. 80,225.

Claim.—A sheet metal profile piece and a

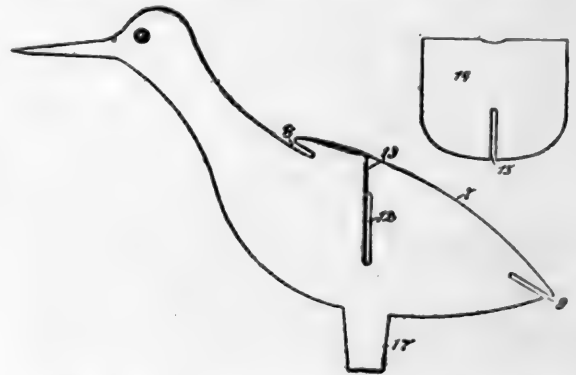

separate and independent flat sheet metal back piece, said profile piece having a slot at the tail end and the back piece having a slot fitting over the profile piece when the back piece is slid into the slot in the profile piece, etc.

August 5th and 7th, last, Andrew and Charles Schoonemaker, of this place, went to Yellow creek to hunt prairie or sage chickens, killing 30 the 6th and 29 the 7th. The younger man is an engineer and spends his time at this end of the road, hunting. When he is at work, his father and the rest of the family go hunting, averaging 4 or 5 days a week.

Prairie chickens are scarce here. Some sportsmen say the sheep tramp out the birds' nests in the spring, but it seems to me the sheep are not entirely to blame.

Florence L. A. Smith, Evanston, Wyo.

Charging the disappearance of prairie

chickens to sheep is new. Sheep are a curse to any big game country, and no doubt they do destroy many nests of birds; but it is due to such persistent and disreputable pot hunters as the Schoonemakers that the sage grouse, and all other game birds everywhere in the country, are gradually being exterminated. August Schoonemaker is game hog No. 923 and Charles is 924.—EDITOR.

If your magazine was read more generally in this State, there would be fewer side hunts, and you would have fewer pictures to print of the work of game hogs. You are doing a grand work and I hope you will keep on until the people have learned what constitutes a sportsman and discovered that there are nobler things in nature than can be found between brick walls in the everlasting fight for wealth.

G. H. Priest, Waltham, Mass.

ANSWER.

RECREATION is very generally read by the decent sportsmen in your State, as well as in all the others; but, unfortunately, there are thousands of game butchers everywhere who do not read it. These are the chaps I am trying to reach, and if sportsmen will send me the names and addresses of any such I will gladly send them sample copies.—EDITOR.

735,290. Snow Shoe. Chandley E. Phelps, Boonville, N. Y. Filed Feb. 7, 1903. Serial No. 142,267.

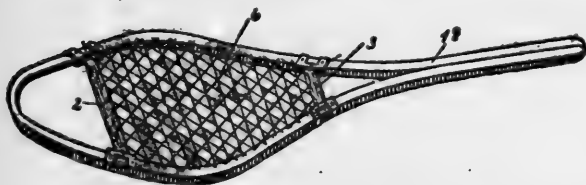

Claims.—The combination of the bow frame, the cross bars and the hanger 4 having a wall extending down on the inside of the face of the bow and a socket therein to receive the end of the cross bars and having means for securing it to the top of the bow.

The principal game hunted here by the true sportsmen is ducks and quails, and if we could read more about this kind of hunting in your journal, I believe it would interest many more in Ohio; but of course you have many readers to please, each of whom has likes and dislikes different from those of the others. I am glad to see the rapid advance our American people are making in their idea of recreation in the field. Doctors advise people in all walks of life to take vacations. If one has his business on his mind 50 weeks in the year, he is entitled to 2 weeks for recreation. He will

live longer by taking them, feel happier, be of better service, and lose nothing but what ought to be lost.

Geo. M. Clouse, M.D., Columbus, Ohio.

730,528. Animal Trap. Alanson D. Gaston, Washington, D. C. Filed Oct. 22, 1902. Serial No. 128,361.

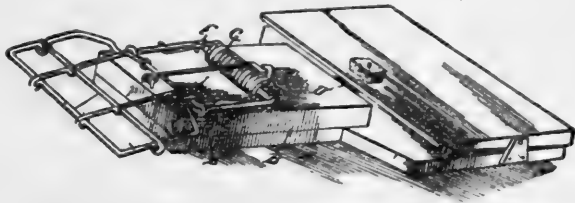

Claim.—An animal trap comprising a base member and a spring actuated bail member, a trigger, and a latch, and a trip-board pivotally secured to the base member and overhanging the end of the trigger member.

Fergus Falls, Minn.—A young man named Paul Meyer was brought into the justice court in this city on complaint of Deputy Game Warden Jones, who charged him with shooting a grouse out of season in the town of Edna. He pleaded not guilty and was convicted after a stubbornly fought trial. The costs in the case were \$58.82, and the court fined him \$10, making a total of \$68.82.

The above, from the St. Paul Dispatch, goes to show that all high priced hunting is not confined to big game. If we had more wardens like Mr. Jones we would have more game.

M. E. Daniels, Monticello, Minn.

Paul's number in the game hog register is 925.—EDITOR.

The game in this section is all shot off by fellows who find a covey of birds and follow them day after day till they are all gone. I promise you to do all I can in this matter, and always what I can toward protection of game everywhere.

W. S. Shaw, Blacksburg, Va.

RECREATION will find a place in our home as long as we have one, and I tender you my thanks for the advocacy of the principles you are putting to the front—game protection and nature study. May there be much more of them in the world before it is too late. You have the heartiest well wishes of the vast army of sportsmen and nature lovers of this country.

James A. Lawrie, Toledo, Ohio.

A little girl thus described a dachshund she had seen: "It was one of those funny ones, you know; the ones that are a dog and a half long and half a dog high. You must know the sort. It is a dog that only has 4 legs, but looks as if it ought to have 6."—The Inglenook.

FISH AND FISHING.

MINNOW CASTING.

In August RECREATION J. P. Jaeger, of Independence, Ia., asks some angler to tell him how to cast flies and small minnows. I shall endeavor to answer, but want to be understood as making no pretense to expertness in this art. Neither do I claim that the tackle and methods I use are the best for the purpose, though they have proven satisfactory to me.

I use a 6 foot Bristol steel rod with single grip, cork handle, Kalamazoo finger-hook attachment, agate guides and agate tip of extra large size. My rod is finished in oxidized silver throughout. My reel is the quadruple multiplier, known as Shakespeare's Professional, with jeweled bearings, and holds 80 yards of No. 5 silk line. I use 60 yards of Shakespeare's Standard silk line, S. S. No. 2, for I prefer to have plenty of room on the reel. I use bass flies tied on No. 1 Sproat hooks, ringed; these I attach to a No. 0 P. and S. ball bearing spinner fastened to the line with a metal coupling.

Having assembled these I wind up my line until the bait is near the end of the rod, place my thumb on reel spool, and throw off both brake and click. When the rod is at the proper point in casting, I release the spool of my reel, but keep my thumb touching and, when I so desire, stop my bait by a slight pressure on the spool. This thumbing is the difficult feature of bait casting and requires practice to perform it nicely. It must be done to prevent the line from over running and back lashing. In casting, the motive power is born of the spring of the rod.

When baiting with minnows, I use No. 1 Sproat hooks on double gut snells and hook the bait through upper lip, except when I use spinners or spoons. With them I use No. 10 Sproat hooks attached to the spinner or spoon, and tie my minnow to the hook by passing a small wire through mouth and gills.

Bait casting is an art requiring considerable practice, some patience and a rod supplied with guides that offer the least resistance to the line.

To practice on shore casting attach to line any small weight, run a tape line 100 feet or less over the ground and fasten at both ends. Stand at one end and cast down this line and note distance cast and accuracy. Soon you will be able to place your bait where you desire.

W. S. Hoke, Wadena, Ia.

HE SHOULD READ RECREATION.

The photograph which is reproduced on this page is the result of one day's fishing in Indian

river, Florida, by Mr. C. M. Hapgood, of Easton, Pa. The total weight of the catch was 105 pounds, the largest fish weighing 13 pounds, and 5 other fish weighing over 10 pounds each. These were all trout with one exception, a bass. Mr. Hapgood fished 5 different days, 3 or 4 hours each day, and caught in all 192 trout, the total weight being 690 pounds.—Boot and Shoe Record.

I wrote Mr. Hapgood, asking if this report was correct and he replied as follows:

Your information is about correct. February 13th I caught, in Indian river, Florida, 32 trout that weighed 95 pounds; largest one, 12 pounds; 14th, 36 trout and 4 bass that weighed 105 pounds, largest one 11 pounds; 15th, 18 trout that weighed 77 pounds; 17th, 12 trout that weighed 45 pounds; 19th, 25 trout that weighed 104 pounds, 5 of them 10 to 13 pounds each; 21st, 11 trout that weighed 50 pounds; 22d, 24 trout that weighed 84 pounds; 23d, 30 trout that weighed 130 pounds, 9 of these weighing 95 pounds; total catch 188; total weight 600 pounds. These weights are exactly those allowed my guide when he sold the fish.

C. M. Hapgood, Easton, Pa.

Here is another case of a man making a hog of himself simply because he does not know any better. Evidently the trouble with this man is that he does not know anything of the modern advancement in sportsmanship. He knows that up to 10 or 15 years ago a man was justified in catching all the fish or killing all the game possible and then boasting of it. Hapgood has innocently had himself photographed with 23 big sea trout. No modern, up-to-date angler would have taken more than 5 or 6 such fish in a day, but Hapgood does not know this. He simply followed the example of old-time fishermen, caught all he could and then had his picture taken with the fish. If he lives long enough to learn what gentlemen think of such work nowadays he will be ashamed that he ever stood up in front of the camera with such an array of slaughter about him and that he ever confessed to having committed such an act of butchery. Hapgood's number in the fish hog pen is 926.—EDITOR.

WHO CAN TELL THEIR NAMES?

A good instance of the proper treatment of fish hogs came under my notice the other day. Six Chicago business men had been fishing at Bang's lake, Wauconda, Lake county, Ill., and some farmers had caught them using a seine. The farmers ordered them to leave town and never be caught around there again; but to their breed the diversion was too tempting and worth the risk, so back they came, camp

and baggage. The farmers soon spotted them and, watching results, saw they were at their old game. The next night, while the hogs were out on the lake, a crowd of farmers collected at their tent and set everything on fire. Being attracted by the flames, the fishermen returned to within talking distance of the shore. Words were exchanged, and 2 of the fellows drew revolvers, discharging several shots, but the farmers did not scare. Instead, they opened up with some well loaded shot guns, rushed out, got the fellows, took them ashore and gave them a sound beating. The Chicago men left town that night via the middle of the road and took a 12 mile walk to Parrington, the nearest railroad station. From what I heard, a number of them will eat their meals off mantlepices for several weeks, as they picked up a number of shot and stopped some large clubs in strong hands. The farmers burned every article the hogs had, from tent down. It would be well if a few more of the fish hog species were treated in a like manner. The names of the party were: Wallace Graham, a young Chicago lawyer; John French, Arthur Briggs and his man, and Walter Holland. McK., Chicago.

The Legislature of Illinois should pass, at its next session, a special act, exempting these farmers from taxation during the remainder of their lives. I heartily commend their example to all other farmers in this country. Can any reader of RECREATION in that vicinity tell me the names of these sturdy sons of toil in order that I may do them further honor?—EDITOR.

THE SPAFFORD-McLEAN CASE.

I am a reader of RECREATION, a sportsman and a lover of fair play. While I believe in upholding our game laws and in the punishment of violators of the same, I think one article in your September issue needs to be taken with salt. It was concerning the shooting of old man McLean last April by Game Warden Bert Spafford, of Cadillac. Public opinion in that section labels the act as a cold blooded murder. Even the friends of Spafford do not claim he was pinned down to the ground by a spear, as stated in your article. There was not a scratch on Spafford's body, though there was a torn place in his coat to help his story.

Old man McLean was a game law violator, and as such deserved the punishment the law provides for such offenses. Personally, he was a kind hearted, harmless citizen and had hosts of friends. I don't know what you think, but I think the life of one human being is worth more than all the game in Michigan.

McLean's was the second life that has been blotted out by the crack of Spafford's

gun. The majority of the citizens of Michigan prefer men, not murderers, for officers of the law.—We haven't any promotion for Mr. Spafford.

W. A. White, Petoskey, Mich.

ANSWER.

I am not prepared to place any value on the life of McLean, but there are men in every community who are not worth the powder it would take to kill them, and a man who will sneak out at night and spear fish in violation of law can, as a rule, safely be placed in that class.—EDITOR.

NEW MINNOW TRAP.

731,398. Minnow Trap. O'Neal Watson, Crawfordsville, Ind., assignor of one-half to Charles E. Lacey, Crawfordsville, Ind. Filed Dec. 2, 1902. Serial No. 133,598. (No model.)

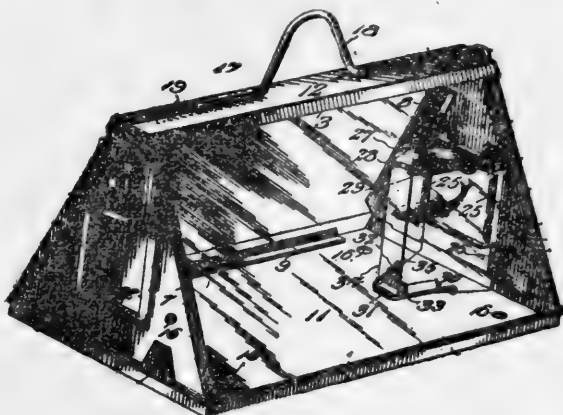

Claim.—A minnow trap comprising a bottom, triangular and plates hinged to the bottom, glass side panes closing the spaces between the end plates, and a ridge plate connecting the tops of the end plates and covering the upper edges of the glass side panes, etc.

TONS OF FISH WASTED.

Avalon, Cal., July 21.—The tons of fish landed in yesterday's slaughter were nearly all hauled out to sea and dumped to-day. Most of the fish which were caught were yellowtail, and there being sufficient of the more edible varieties, such as barracuda and bass, to supply the local and shipping demands, the yellowtail were all thrown away. Probably 2 tons of this single variety were thus disposed of. Many of the launches which came in loaded yesterday did not stop to unload the fish, but steamed back out to sea and threw them overboard. Scores of fish brought in in rowboats were dumped on the beach, and thrown back into the water to-day. The wanton slaughter and the reckless waste of these edible varieties of fish was an old story to the local inhabitants, but to the big crowd of summer visitors, unused to such scenes, it appeared like a cruel sacrifice. Many of the fishermen as well as the visitors condemn these wholesale slaughters.

The above item, from a California paper, will give Eastern anglers an idea of the slaughter that is constantly going on at the West coast fishing resorts. Fish were never more plentiful and fishermen never

so numerous. A few copies of RECREATION distributed at Avalon and Redondo might have a good effect.

B. C. Hinman, Long Beach, Cal.

NIBBLES.

730,064. Trolling Spoon. Albert W. Wilson, San Francisco, Cal. Filed April 14, 1902. Serial No. 102,785. (No model.)

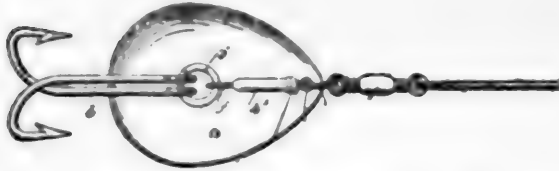

Claim.—A link for fishing gear, said link comprising a section of wire bent to form 2 eyes respectively at the ends of the link, the end portions of the wire being projected past each other and laid back alongside of the middle portion, a clamp fastening said end portions snugly against the middle portions, said end and middle portions of the wire forming the shank of the link, and a covering inclosing said shank and extending continuously from one eye to the other, etc.

I enclose a clipping from the Battle Creek Journal, which I wish you would publish. Roast these bristlebacks brown.

C. R. O., Climax, Mich.

Patrolmen Miller and Godsmark were fishing yesterday on Sherman lake. The report of their catch is 724 bluegills.

I wrote these men for confirmation of this report and received the following reply:

The report is correct except as to the number of fish, which was 725.

Sidney Godsmark, Battle Creek, Mich.

It is not necessary to waste valuable space in telling you what I think of you, any further than to say that I have entered your name in the fish hog book as No. 927, and Miller's as No. 928. Thousands of decent men who read of your exploit will form their own estimate of you.—EDITOR.

Mr. A. Judah reports the following catch of small mouth bass in Belgrade lakes, Me.: Friday, 75; Saturday, 68; Monday, 73; Tuesday, 72; Wednesday, 69; Thursday, 64. Mr. Judah says that this is the record on the lakes, except his own of last year, which was better. He goes after fish the same as another man would shoot birds, in a business way. He takes a guide and a boat, starts at sunup, and stays till dark. The guide cooks the noon meal and Judah fishes.—Kansas City Journal.

On inquiry, Mr. Judah writes as follows:

I caught 105 small mouth bass in one

day in Belgrade lakes. For small mouth bass fishing there are no better lakes in Maine than Belgrade.

A. Judah, Kansas City, Mo.

If all the people who go to Belgrade lakes wore such bristles as you do the fishing there would not be worth 10 cents a day in 2 years from now. Your number in the fish hog book is 929.—EDITOR.

I have just heard that Will Thomas and a friend from Roxbury, Me., caught 800 brook trout yesterday. Kindly write them and find out if true; then see that they get advertised in good shape.

E. S. J., Rumford Falls, Me.

My inquiry brought the following answer:

Who reported the trout that a friend and I caught? We both caught 400 fish in one day and their weight was about 50 pounds.

William Thomas, Roxbury, Me.

It matters not who made the report. Your own statement is sufficient to brand you and your friend as fish hogs with unusually long bristles. Your number in the fish hog record is 930, and I only regret I have not the name of the rooter who accompanied you.—EDITOR.

In my capacity as justice of the peace I have had the pleasure of soaking it to 2 persons for seining in Lake Shetek; one paid \$50 and costs, the other \$100 and costs. There is a warrant out for another fellow, and it will cost him \$100 when he is brought in. This has driven from the lake several persons who have been seining fish for a living. I was also instrumental in getting the game warden here last year, when we caught the Walnut Grove crowd. It cost them \$157 to square up matters, as reported to you by Rear Warden Morgan, of Albert Lea, Minn., last winter.

Chas. E. Price, Currie, Minn.

Here is another administrator of the law who knows how to deal with game and fish pirates. I wish we had such men in every township of the United States.—EDITOR.

POACHERS FINED.

The Kennebec, Me., Journal says: John A. Brown of Smyrna Mills, deputy sheriff of Aroostook county, Dr. Wellington of Boston, and John Mitchell of Moro, were caught recently netting trout in Hope pond in Moro plantation. They were prosecuted by Warden Templeton and were convicted and paid a fine of \$50.—Bangor, Me., Daily News.

This is an astonishing report to be sent out about a deputy sheriff and a Boston doctor, especially. The report does not say anything as to John Mitchell, but I take it for granted his ideas of sport must be of a degraded sort, or he would not have been

found in such company. I am glad these men were tried before a judge who knows how to deal with such disreputable characters. Deputy Sheriff Brown's number in the pig pen is 931. Dr. Wellington's is 932 and John Mitchell's is 933.—EDITOR.

Can you tell me how to determine the age of brook trout?

H. B. Thompson, Somersworth, N. H.

ANSWER.

If you refer to wild brook trout, it is practically impossible to tell their age with any degree of accuracy. The age must be estimated largely from the size, but that varies materially with their environment and the abundance and kind of food. In New Hampshire, wild brook trout ordinarily run 6 to 8 inches in length when 3 years old, although it is possible, under favorable conditions, for a 3-year-old brook trout to weigh half a pound. To be able to determine the age of brook trout in any particular stream, special observations would have to be made for a series of years.—EDITOR.

736,880. Fishing Reel. Edward D. Rockwell, Bristol, Conn. Filed March 7, 1903. Serial No. 146,773.

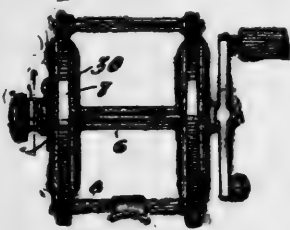

Claim.—In a fishline reel, the combination, with a drag, of a knob controlling said drag, and an indicating point mounted on said knob and capable of movement with relation thereto, etc.

Messrs. Frank Deno and E. J. Falkner returned from a 3 days' fishing trip down on the Big Hole river near Twin Bridges, last Saturday. Their catch for the 3 days numbered between 1,000 and 1,200.—Dillon, Mont., Examiner.

Regarding this report Falkner says:

My fishing is not in the least overestimated in the report you mention.

E. J. Falkner, Rochester, Mont.

Your fish hog brand is No. 934 and Deno's is 935.—EDITOR.

Harrisburg, Pa.—In Centre county last week a fish warden of the Pennsylvania department of fisheries caught John Kosick and J. L. Millard fishing for trout. They resisted the efforts to examine their baskets and the officers were compelled to use force. Twenty-eight trout under 6 inches in length were found in their possession. They pleaded guilty to violating the fish law and paid \$280 fine for the short trout and \$100 each

for resisting the officer, making a total of \$480.—Altoona, Pa., Tribune.

Kosick's number in the pen is 936 and Millard's is 937.—EDITOR.

Ed Medbury and his brother Louis caught 400 trout in the river near Medburyville the other day.—Deerfield Valley, Vt., Times.

To my inquiry Medbury replied:

The number of trout caught by my brother and me in one day was 405

E. F. Medbury, Wilmington, Vt.

Your name goes down to posterity in the fish hog book is No. 938 and that of your brother as 939.—EDITOR.

While dynamiting a stream to kill fish, at Walter, Okla., Professor E. Horn, a prominent educator of Alabama, was killed by the explosion of a cartridge in his hands.—Exchange.

Here is another dynamiter who got what he deserved.—EDITOR.

AN EXPEDITION.

EFFIE L. EDLER.

Jimmie went a fishin'
With his pa to-day;
Carried bait and triggins,
Walkin' all the way.
Took a little lunch along,
An' some water, too;
How th' fish'l suffer
'Fore the evenin' dew!
If they come home loaded
Jimmie will recite
'Bout the little fishes
'Fore he says good night.
'Spect his little prayers'll be
Mixin' in the brook,
Tellin' Jesus how he
"Caught 'em with a hook."
But I think the Lord will
Keep him 'till the morn,
For he is the dearest
Boy that e'er was born.

Beginning about the 25th of each month, I haunt the news stands until RECREATION comes out. I consider it the best magazine published, and I have read all of them. The Gun and Ammunition department affords a great deal of information and considerable amusement. From the first to the last page you pound away at game hogs with great persistence and very plain language. They deserve it all and I hope it will do them good.

A. C. Ludington, Marquette, Mich.

"What was old Thornson grumbling to you about? His health, as usual?"

"Yes. He complained that he was feeling somewhat better."—Exchange.

GUNS AND AMMUNITION.

Anybody can shoot all day, but a gentleman will quit when he gets enough.

WINCHESTER SAYS YES AND NO.

T.C. BENNETT, President

G.E. HODSON, V. Pres. & Treas.

H.S. LEONARD, Asst. Treas.

A.J. WARD, Secretary.

WINCHESTER REPEATING ARMS CO.

MANUFACTURERS OF

RIFLES, SHOT GUNS & ALL KINDS OF AMMUNITION.

ALL LETTERS SHOULD BE ADDRESSED TO THE COMPANY.

A. 65590

NEW HAVEN, CONN. U.S.A.

September 23, 1903.

Mr. A. V. Huyler,

C/o H. H. White & Co., #21 Maiden Lane,
New York, N.Y.

Dear Sir:-

Replying to your favor of the 22nd inst., would say we shall probably put an automatic shot gun upon the market, but we are not prepared at this time to give any information concerning it and we can say that it will not be done this year.

Yours respectfully,

Winchester Repeating Arms Co.

H. S. Leonard Asst. Treas.

#

New Haven, Conn.
November 2, 1903.

Mr. Charles Vitous,
522 W. 25th St., Chicago, Ill.

Dear Sir:

We note your protest against something which we do not happen to have.

We regard the advertisement of the Browning gun in RECREATION as a skilful piece of work on the part of the editor. He set forth the good qualities of that gun with great distinctness; at the same time threw

as much mud at the Winchester Company as he was able. A few people may be deceived. We feel that the editor was not acting in good faith. He started to advertise the Browning gun. He was afraid to do so openly. He would like to show the Winchester Company at fault.

Nobody can be more interested in the preservation of game than the Winchester Company.

Yours respectfully,
Winchester Repeating Arms Co.,
(Signed) T. S. Bennett, President.

F. C. BENNETT, PRESIDENT.

G. E. HODSON, V. PRES. & TREAS.

H. S. LEONARD, ASST. TREAS.

A. J. WARD, SECRETARY.

WINCHESTER REPEATING ARMS CO.

MANUFACTURERS OF

RIFLES, SHOT GUNS & ALL KINDS OF AMMUNITION.

ALL LETTERS SHOULD BE ADDRESSED TO THE COMPANY.

H. 98263. NEW HAVEN, CONN. U.S.A.

November 6, 1903.

Mr. C. F. Dill, Chief Warden,
Greenville, S.C.

Dear Sir:--

We have your valued favor of the 31st October, and would say in reply that we suppose that your letter is influenced by the article contained in RECREATION, which was a hit at us, - dishonestly we think. The Editor wanted to advertise a certain automatic shotgun, and did so describing in detail its excellencies and giving the name of the maker. He covered this by urging the readers to take a decided stand against the Winchester company. We regard it as unfortunate for our interests that we have not any gun of the kind. We feel, however, on the basis of the interest which has been excited by the magazine in question, that the people desiring automatic guns are very much greater in number than those who do not desire them.

We believe in the preservation of game, but do not believe that game will be preserved by any delay in the state of any art. People who want these guns are not "pot-hunters", but people who do not believe as you do, and have a different opinion of the Editor of RECREATION.

Yours respectfully,

Winchester Repeating Arms Co.

T. S. Bennett
President.

New Haven, Conn.
November 6, 1903.

Mr. Chas. H. Bentley,
Hampden, Va.

Dear Sir:

We have your valued favor of the 4th November, and note contents of the same.

In reply we would say that since we withdrew our advertisement from RECREATION we have noticed that the editor's position toward us has been somewhat more acrimonious. We do not think he is acting honestly with you or with us. He put out a good ad for the Browning automatic gun,

describing its extreme efficiency and giving the name of the makers; and then by way of saving his face he started a campaign against the Winchester company. We feel that it is unfortunate we have not a gun of the kind described at present. We are quite sure you will change your opinion about decent sportsmen, and we are just as anxious to preserve the game as you are. We are glad to know you have entertained a high regard of us, but are sorry to hear we are liable to lose it if we continue to perfect guns.

Yours respectfully,
Winchester Repeating Arms Co.,
(Signed) T. S. Bennett, President.

It will be seen that in the letter from the Winchester company reproduced herewith and dated September 23, they say:

"We shall probably put an automatic shot gun on the market."

I know from other reliable sources that they have been busy several months building machinery for the making of an automatic gun.

Then in the letter to Mr. Vitous they say,

"We note your protest against something which we do not happen to have."

Not yet, of course, but they are making it.

In the letter to Mr. Dill, dated Nov. 6, 1903, Mr. Bennett says:

"We regard it as unfortunate for our interests that we have not any gun of the kind."

In the same letter Mr. Bennett says:

"The editor wanted to advertise a certain automatic shot gun, and did so, . . . giving the name of the maker."

These statements are directly in conflict.

Mr. Bennett accuses me of advertising a rival gun, and of naming the maker thereof, in my editorial in November RECREATION. I will give Mr. Bennett \$1,000 if he will point out to me the name of the makers of the other automatic gun referred to in that article. As matters now stand Mr. Bennett himself has the honor of first having advertised the Browning gun in RECREATION, and the makers of that gun are welcome to whatever good this may do them.

Under date of October 14 I wrote this to Browning Brothers:

Dear Sirs:

I am sorry to learn that you have put out an automatic gun. If I had known you contemplated this, I should have advised you against it long ago, though I do not imagine you care for any advice from me.

It would seem that the small remnant of wild birds which now remains, of the millions that were formerly on this continent,

could be killed off fast enough with the double barrel guns and pump guns; and I regret that a still more destructive weapon should have been made and offered for sale.

While not wishing to injure your legitimate business, I shall oppose the use and sale of these guns to the best of my ability.

Yours truly, G. O. Shields.

Mr. M. S. Browning replied to this, under date of October 24, as follows:

Dear Sir:

Replying to your favor of 14th would say, if the only way to protect the game was to limit the efficiency of the gun you would have to advocate the flintlock; and even that arm, if unrestricted, would be an awful game exterminator. There are general restrictions that are properly made, limiting the season, the bag, the bore, marketing, etc., to amply protect the game, and as arms have been made more effective the lines have had to be drawn closer.

Am sorry you have decided to oppose the arm, as we had expected to be able to make satisfactory arrangements for advertising with you when we were prepared to advertise.

Yours truly,
M. S. Browning.

If Mr. Bennett doubts the authenticity of these letters, I shall be glad to have him call, or send a man here, and I will show him my carbon copy of my letter to Browning Brothers, and Mr. Browning's original letter to me as quoted.

I should further like to have Mr. Bennett point out to me any mud I have thrown at his company, or anything that has appeared in RECREATION since he withdrew his ad that is in the least "acrimonious" toward his company. On the contrary he can find on page 376 November RECREATION 2 articles defending the pump gun which Mr. Bennett makes. On page 377 of the same issue I printed an article entitled "The Ideal Gun," which strongly recommends certain of the Winchester rifles. On page 380 is another article commending the Winchester pump gun. On page 384 the Winchester 25-35 rifle gets a good send off. Then on page 460 of December RECREATION the Winchester Company gets more free advertising. Will Mr. Bennett please point out to me any instance in which I have treated him "acrimoniously" since he withdrew his ad?

My protest against the automatic gun, in November RECREATION, is a straightforward, manly appeal to the sportsmen of the country on behalf of the birds. I made no attempt whatever to injure the Winchester Company. They had announced in writing their intention of placing on the market an automatic gun, and I undertook to have my

readers convince them that such a gun should not be made and sold. Mr. Bennett has seen fit to force a fight on me; but whatever I may do or say in this matter, hereafter, will be entirely fair and unprejudiced.

Inasmuch as the Winchester Company seems determined to go ahead and put out this automatic gun, and inasmuch as Browning Brothers have already put one out, I, in common with many other sportsmen, realize that the time has come to prevent by law the sale and use of all repeating shot guns. Hence I have drafted a bill to prevent the use of these weapons and have sent copies of it to all the Chief Wardens of the League, and to many other prominent sportsmen, with a recommendation that it be introduced in their respective legislatures at the earliest possible date and pushed for passage. Here is a copy of the bill:

AN ACT TO PROHIBIT THE USE OF REPEATING SHOT GUNS IN HUNTING BIRDS.

The people of the State of _____ represented in Senate and Assembly, do enact as follows—

Section 1. It shall be unlawful to use, in hunting birds or animals of any kind, any shot gun holding more than 2 cartridges at one time, or that may be fired more than twice without reloading.

Section 2. The intent and meaning of this bill is to prohibit the use of any so-called repeating shot gun or pump gun.

Section 3. Any person found guilty of a violation of this statute shall be fined not more than \$50 nor less than \$25 for each offense; and the carrying of any such gun in the woods or in the fields or on any of the waters of this State shall be considered *prima facie* evidence of an attempt to violate Section 1 of this statute, and shall be punished as provided in this section.

Will Mr. Bennett please point out to me any instance in which I have shown partiality to Browning Brothers in framing this bill?

MORE PROTESTS AGAINST THE AUTOMATIC GUN.

Forsyth, Ga.

Winchester Repeating Arms Co.,
New, Haven, Conn.

Dear Sirs:

I have read in November RECREATION a protest against a wrong which you are about to commit against the game of this country, by manufacturing an automatic shot gun. This is a matter which has concerned me for some time past. My attention was first called to it by a friend in Macon Georgia, who is a dealer in sporting goods. We were discussing the advent of

the 20 guage double as a genteel, sportsmanlike weapon which would cultivate a sportsmanlike spirit in any man who would use one. He remarked that there would soon be placed on the market an automatic gun, and that it would have to be manufactured in either Belgium or Germany, as the Winchester people had refused to make it, on account of the general disapproval of such weapons, and the fact that its advent would result in the repeating guns being outlawed. He said he was opposed to selling an automatic gun, as he believes in a man's being a clean sportsman, and not a game butcher. I was glad to hear that no American concern would agree to make such an engine of destruction, for the introduction of such a gun would mean the extermination of our game birds.

I use a double gun, and so does my hunting companion. We have shot 7 years over the same ground, and to-day have as many birds as ever, because we are careful to leave a sufficient number out of each covey to provide breeders the following season. If this automatic gun is made and placed in the hands of a game hogs, who will be the only ones to use it, the provident care of game by the sportsmen will not amount to much.

I notice that one automatic gun is now on the market and is doubtless being sold to men who are not satisfied with decent bags. This we can not prevent at once, but we can and do protest against another manufacturer's taking up such a weapon.

Let the protest of the men who want to hunt the game and yet keep it, be heard and heeded. Your repeater should satisfy you. The coming of the automatic will ultimately mean the outlawing of the pump gun, as well as the automatic, and I shall try to have a bill passed at the coming session of the Georgia Legislature, to prevent the use of the automatic shot gun in this State.

Respectfully yours, G. O. Persons.
Baltimore, Md.

Mr. G. O. Shields,
New York.

Dear Sir:

I heartily commend your editorial in November RECREATION on automatic guns. You will notice by the papers I sent you a day or 2 ago, containing a report of the annual meeting of our association, that I recommended the passage of such a law by the coming Legislature of Maryland, as will make unlawful the use of pump, or magazine guns. I expect to prepare such a bill to be presented to our Legislature, which will convene in January next.

I shall be glad to unite with you in such manner as you may indicate to prevent the

use of these slaughter guns, and you may rely on Maryland doing what it can to prevent their use.

Kindly indicate to me any course you may propose to pursue in the matter, and I assure you of my hearty co-operation.

Yours truly, Oregon M. Dennis.
Secretary Maryland Game and Fish Protective Ass'n.

My Dear Coquina—I strongly endorse your protest against the automatic gun. It is shocking to think of the continued development of sporting guns, though it was proved 20 years ago that we had already reached the point where the destructiveness of the weapons was greater than the recuperative power of the game. Among-water fowl we have stopped swivels and batteries, and I should be in favor of abolishing not only automatic guns but repeating shot guns and repeating rifles in field sports. E. T. Seton, New York.

THREE NEW EJECTORS.

732,891. Ejector for Firearms. Hermon L. Powell, Utica, N. Y., assignor to Remington Arms Company, Ilion, N. Y. Filed May 2, 1903. Serial No. 155,239. (No model.)



Claim.—The combination in a breakdown firearm of the frame, barrel and barrel lug jointed to the frame, a sliding ejector mounted in the barrel lug, a starting lever and an ejector hammer both pivoted in the barrel lug and adapted to operate on the ejector, a projection on the frame to engage and operate the starting lever, a sear operating to secure said hammer and adapted to engage the frame adjacent to the joint pin and a spring for operating said hammer.

730,862. Ejector for Firearms. Charles Y. Bartholmes, Ilion, N. Y. Filed April 10, 1903. Serial No. 151,888.

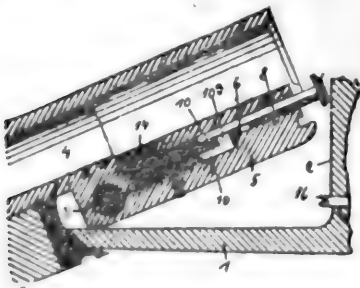

Claim.—The combination with a firearm

having a frame and a barrel and lug jointed to the frame to breakdown of the ejector mounted on a longitudinal slide in the barrel lug and having a catch shoulder and a forcing spring of a catch and tripping lever having a shoulder to engage the shoulder on the ejector slide and mounted on a vertical pivot in the barrel lug and a cam surface on the side of the frame to engage and operate said lever.

732,187. Ejector for Firearms. George E. Humphreys, Ilion, N. Y., assignor to Remington Arms Company, Ilion, N. Y. Filed April 13, 1903. Serial No. 152,352. (No model.)

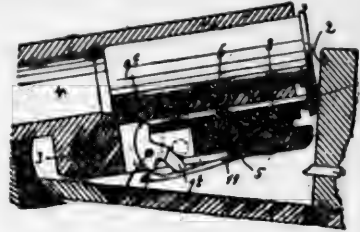

Claim.—In an ejector mechanism for firearms, the combination of the frame, the barrel, a barrel lug adapted to enter a recess in the frame, the ejector slidingly mounted in the barrel lug, a fillip arranged to strike the ejector and having an arm, a spring having a tooth co-operating with a corner on the fillip and a projection on the frame adapted to engage the arm of the fillip.

THEY STILL WRITE PETERS.

Grand Rapids, Mich.
The Peters Cartridge Co.,
Cincinnati, Ohio.

Dear Sirs—I notice in a recent copy of RECREATION a letter indicating a controversy between you and the editor of that publication. I am surprised to learn that you make strong objections to a criticism such as was published, and, which, by the way, I noticed.

I am personally a strong advocate of Peters ammunition, and have been using it several seasons. A large number of members of our local clubs are using your ammunition. I have never heard any complaints about it here, but I have on one or two occasions known of complaints from persons in other localities.

I do not think you are justified in making the kick you do against Mr. Shields. When I was advertising Clipper bicycles in his magazine, he did the same thing with me that he has done with you; it resulted in much good for the Clipper. I believe you will find that criticism has made friends for you or rather has brought out your friends. I also believe you should not discontinue your advertisement with RECREATION.

Mr. Shields is doing a great work in the game protection cause and he has lots of

friends; his work will benefit every gun and ammunition maker in the country, and I think all such concerns should favor his magazine.

It is not often that I write a letter in defense of a publisher, as I have been for years an advertiser, and in the same boat with you; but in this case I believe I am justified in writing you this letter, and believe you will appreciate it and take it in the spirit in which it is written.

I do not deny that I am a strong friend of Mr. Shields and a friend of RECREATION, but I am also as strong a friend of Peters ammunition, and I do not wish to see the manufacturers of this ammunition antagonize the publication.

J. E. P.

Ware, Mass.

The Peters Cartridge Co.,
Cincinnati, Ohio.

Dear Sirs: "It is the hit bird that flutters." Why not improve your shells? Every true sportsman will stand by Mr. Shields, because if it wasn't for him there would be, in a few years, no use for your ammunition or any other, as game would be gone. Since you have discontinued your ad in RECREATION, every thorough sportsman ought to discontinue the use of Peters shells, and advise his friends to do likewise.

H. F. Moulton.

Columbus, Ohio.

The Peters Cartridge Co.,
Cincinnati, Ohio.

Dear Sirs: Being a sportsman and a user of King's powders and Peters' cartridges, I feel I have the privilege of expressing my condemnation of your action in withdrawing your ad from RECREATION. I shall cease to use your goods until your ad once more appears in RECREATION. Geo. O. Peters.

LOADING THE 25.

The 25-21 and the 25-20 cartridges are excellent for small game shooting and will make as good a target at 200 yards, under favorable circumstances, as many of the larger calibers. They are, moreover, much pleasanter to shoot. For target, use the shell full of semi-smokeless ffg. with a light card wad to hold it in, a common black powder primer and an 86 grain bullet. No. 25,720, tempered 1 to 20. Seat the bullet by hand in the barrel the depth of its own length or deep enough so the muzzle of the shell will reach the base of the bullet when the action is closed.

For hunting, DuPont smokeless rifle No. 1 can be used, with a nitro primer and a 75 grain hollow pointed bullet, 1 to 40. Enough of this powder should be used so the bullet will be seated snugly on it without pressure. Care should be used in measuring each charge, for if it is compressed in the

shell it will cause irregular shooting. This cartridge is death to woodchucks. A sharp pointed bullet can be used instead of the hollow point and small game can be shot through the body without mutilation. Black powder or semi-smokeless fouls badly when used in reduced charges. DuPont smokeless shot gun powder with a nitro primer is all right; but do not attempt to use a full charge of any shot gun smokeless in a rifle. The bullet should be seated the same as if the full charge was used and the powder left loose in the shell.

For full charges semi-smokeless is cleaner and makes less smoke than black powder, and good results can be obtained with black powder primers. Nitro primers or smokeless powder or a combination of both, I do not know which, is destructive to brass shells, rendering them brittle in a short time and causing the heads to blow off. This, however, can do no great harm if the shooter has been thoughtful enough to provide himself with an Ideal broken shell extractor.

I never had the trouble that some claim to have experienced in keeping the quick twist, small bore smokeless rifle in good condition. My method is to use, as soon as I get through shooting, a tight fitting rag wet with strong soap suds. This, with the proper amount of elbow grease, will be sufficient for removing every particle of dirt. Then use dry rags until the bore is perfectly dry before oiling. The bore should always be slightly oiled after firing a metal patched bullet and before firing a lead one.

E. O. Raynor, Meadville, Pa.

ANSWERING MR. BECKWITH.

Alvaie Beckwith, Lincoln, Neb., asks a question in April RECREATION in regard to the Magniscope rifle sight. I have the only one in this part of the country, as far as I know. I consider it a success and a valuable addition to the equipment of any rifle. Mine is on a Stevens Favorite, 22 caliber, and magnifies 2 diameters. For a longer range gun I should choose the 4 power glass. The Magniscope is nothing more nor less than a telescope without the cumbersome and unsightly tube. I use the Lyman No. 2 rear sight with the eyepiece of the Magniscope fitted in the disc. By screwing out the disc and folding down the lens which is fitted in the rear sight slot, I have the ordinary Lyman sights for quick shooting. Turning up the lens and screwing in the disc, I have a first class telescope sight.

Some improvements could, and doubtless will, be made in the manufacture and handling of the Magniscope. My order was out about 6 weeks before it was filled, and when the sight finally came it was mounted on a base to fit the front sight slot instead

of the rear, which made necessary about an hour's careful filing. The lens was fitted into the ring of a Lyman No. 5 front sight, the pin having been cut out.

If the Savage people would buy the Magniscope and make it as well and advertise it as extensively as they do their other goods it would be only a matter of time when the tubular telescope sight would be a thing of the past, except for very long range target work, where a greater range of adjustment is required than can be had in the present form of the Magniscope. It would be easy, however, to improve the Magniscope in this respect.

The gun and ammunition department of RECREATION is worth the price of the magazine. So is the fish and game hog department. Long may your banner wave.

L. V. DeWitt, Paris, Tex.

The men who made the Magniscope sight proved thoroughly unreliable, and I am glad to say have quit. Mr. Marble, president of the Marble Safety Axe Co., Gladstone, Mich., is working on an improved form of this sight, and will probably put it on the market in the near future.—EDITOR.

IMPRACTICABLE TOOLS.

That a tool fails to perform the work for which it was designed may be the fault of the user, but it is sometimes due to the impracticability of the tool. The latter is certainly the case with the Marlin rifle. I have taken one apart and polished each separate piece of its mechanism in the endeavor to make it work smoothly. The extractor, a wee bit of hook and spring, is particularly worthless. I suggested an improvement to the company and got a snub for my pains.

After trying all the new model rifles I consider the 32-20-105 the best for target work and for game up to turkeys. For deer I choose a 40-82, a 38-55 or a 38-56. The 30-30 makes too small a wound and does not draw blood enough to track by.

My pet shot gun is an Ithaca. With Winchester high base shells it does excellent work. Some time ago I was persuaded to try Peters New Victor shells. My first attempt with them was on squirrels. I peppered several at ordinary range and they merely looked around to see what hit them. I did succeed in killing 2 or 3 within 25 yards, but I think they died from fright. The load was $3\frac{1}{2}$ drams powder and $1\frac{1}{8}$ ounces No. 7 shot.

W. B. Seavolt, Newhaven, Pa.

SMALL SHOT.

Would it not be well to give the liars a department of their own, instead of scattering their fancies promiscuously through RECREATION? We have heard from the man

who kills deer with 22 shorts, the man who never fails to make a heart shot, the man who kills quails at 90 yards, and many others. Probably we shall hear from them again. We may, however, hope that the man is dead whom the cougar covered with leaves while she went after her cubs, since that occurrence was first reported soon after the expiration of Ananias' copyright.

If you can not spare them a department, it might answer to tag them as you do the hogs; for instance, "How I killed 4 Bear with a Puttyblower, By J. J. Jones, Liar No. 747." Then we would know what to expect before reading.

R. E. Peater, Mansfield, O.

Do the Ideal people make a mould for a bullet, weighing 200 to 250 grains, that can be used in a Colt 44 caliber powder and ball pistol?

M. R. Williams, Omaha, Neb.

ANSWER.

I do not know of any mould made by the Ideal people to cast a bullet to fit your revolver and weigh as much as you require. Their No. 450,225, weighing 170 grains, will probably fit.

The better way is to send the Ideal Company a bullet that fits the barrel and takes the rifling well, and see if they cannot furnish you a mould to suit. Most of the 44 caliber Colt and Remington powder and ball revolvers of the Civil War period required a ball with a diameter of .450 of an inch.—EDITOR.

While I own and use a 22 rifle, I can not help thinking that the world would be better off without these destructive little weapons. They are too cheap and handy and tempt unthinking boys and men to wanton destruction of song birds and small animals. While connected with a saw mill in the woods last summer, I noticed that 3 of the crew carried cheap 22 rifles to and from their work for the purpose of shooting any birds they might come across. These fellows became expert and seldom missed a shot. Either the price of small rifles should be raised sufficiently to keep them out of the reach of irresponsible persons or a tax should be put on their use.

R. B. Stowers, Cupio, Ky.

Please explain why 22 long U. M. C. cartridges stick in my rifle. They will not go into the barrel. Would a 22 long kill a rabbit at 75 yards? Have had many misfires when using Peters shells.

A. C. Adams, Pitcairn, Pa.

Will some one who has had experience with W. W. Greener guns kindly give his opinion of them?

W. C. Garthwaite, St. Marys, Ont.

NATURAL HISTORY.

When a bird or a wild animal is killed, that is the end of it. If photographed, it may still live and its educational and scientific value is multiplied indefinitely.

SIX WOODPECKERS.

FRANCES ANTHONY.

I have a tender spot in my heart for a flock of woodpeckers that live in our trees. Six of the 8, if not all, were born in a soft maple tree in our yard.

This morning, just before getting up time, there was a series of rap-rap-rappity-raps in the gable over my front window. All the opening and shutting of windows in my efforts to see which or how many of them were there seemed not to disturb the birds in the least; they kept it up just the same, and judging by the number that were flying around they may have taken turns at it. Even above the noisy, chattering of blackbirds holding a mass meeting in the evergreen thicket, it could be plainly heard. The difference between the 2 musical exercises was noticeable. While that of the blackbirds was noisy and confused, this of the woodpeckers seemed dignified, purposeful and orderly; and, as I listened longer, it grew to seem like a Sunday morning salute to the rising sun.

In the growing up of these woodpeckers I have been much interested. It was by accident I found their home, though I had noticed in early spring a pair of woodpeckers hanging around that tree. There seemed to be considerable discussion and matters did not go to suit. After a while I forgot them; other trees hid the maple from view and I was busy about other things. One day in May the cat brought a young owl from the corner of the yard. Following the clue, I found a living owl under the fence and a dead one under the maple. In another tree sat the frightened mother owl, her horns standing straight up and her bright yellow eyes blinking as she tried to understand what we were doing. After some searching we found the hole in the maple and in it still another owl. The poor little things felt and looked forlorn enough, being nearly naked, and they put on their stupidest air. We put them back in the hole that to them was nest and home; and several days passed before I solved the mystery of their having been out of the nest before they were large enough to take care of themselves. I could not believe a cat had pulled them out, so, putting a ladder up to the tree, I kept watch.

A few days later I found 2 headless field mice, a kangaroo mouse in like condition, and a dead titmouse under the tree where the owl's nest was. One day I saw the pair of woodpeckers making a great fuss in

the tree, looking into the hole and flying about. Then I knew the whole story; they had intended to use that hole themselves, as they had probably done in other years, but Mrs. Owl got in first and kept possession, either by force or simply by being present when other would-be occupants came prospecting. So there she brought her family up till they reached an age of pin feathers and plumpness suitable to the taste of cats. Food would not come to them; it must be sought, and the older they grew the more they took. In a luckless hour the mother went to seek it.

Mrs. Woodpecker and perhaps Mr. Woodpecker, too, happened along just at the right time and made the most of one of those opportunities that are one bird's gain at another's expense. They dumped those precious little owls out on the ground. Then they were puzzled what to do next; they couldn't use the nest, for Mrs. Owl would see to it that all their eggs were eaten. Well, if they must give up one thing they would try another, so out went all the food, all the choice little birds and mice that Mrs. Owl had left for the children to eat. It was these things lying under the tree that told the story. In spite of everything the owls grew. The woodpeckers showed impatience, and after a time grew so bold as to go right in when the mother was gone and cut and chisel the nest out to suit themselves. Several times I slipped quietly up the ladder and, as soon as I could reach, put my hand over the hole, held it there while I climbed the rest of the way, and then finding Mrs. Woodpecker crouching flat above the owls, took her out in my hand and let her fly away.

The young owls proved a pair; one being broad built and round of face, the other slimmer in body and face and having a pair of horns like the mother. After a while the little brown beauties flew away, and the next day a new home was begun in the hole in the maple tree. A creamy white woodpecker's egg was laid there, the next day another, and so on till there were 6. Then after a while there were 5 naked squirming little woodpeckers and one egg; the next day the egg had disappeared and there were 6 ugly looking specimens that reminded me of nothing so much as diminutive plucked geese. Finally the birds flew away, claimed their title to the freedom of their kind, and came back only to the tree tops and their drumming spot on the house. The puzzle to me is that now

I can not tell any of the 6 or their parents apart.

BAND-TAILS; NOT PASSENGERS.

I am sending you the head, wings and feet of what I believe was a real old time wild pigeon. This year there have been countless thousands of them in the mountains of this State. I know of 100 having been killed in a day by one gun. They are not protected here, but you bet they will be next year if they are the real thing.

Lundy, Stanwood, Wash.

ANSWER.

The head, wing and feet which you sent are those of a band-tail pigeon, and not of a passenger pigeon. The former is fairly plentiful along the coast from British Columbia to lower California, and it is a great pity the coast States do not enact laws for its rigid protection.

It will be another national disgrace to have this beautiful and useful bird wiped off the earth, as its Eastern relatives have been. You and every thoughtful, careful sportsman should refrain from shooting these birds, and should begin an active campaign to induce your Western Legislatures to pass laws placing a 10 years close season on the band-tail pigeon.—EDITOR.

ANSWERING MR. BADGER.

Answering L. M. Badger in August RECREATION, the tree was probably a buck oak, and the horn growing near the top was torn off by the wind, or fell when ripe, and lodged in the crotch, or it might have been a dropped horn carried upward on an acorn shoot. More likely I picked it up years ago and in an idle moment hung it in the forks; if so, I am sorry the points were gnawed. As the crotch was 8 feet from the ground, I think the gnawing was done by a giraffe; they will do it every time if not watched. Of course, a porcupine or a badger might have done it.

Naturalist, Pittsburgh, Pa.

The deer horn found by L. M. Badger imbedded in the trunk of a small tree was doubtless placed by some one in a crotch of the tree when it was a sapling. The wood gradually grew about and imbedded the horn, just as growing wood often imbeds fence wire. The gnawing of the horn was probably done by red squirrels. It is a common habit of theirs here in Minnesota. Henry Joerg, Madelia, Minn.

THESE ARE ALSO BAND-TAILS.

I was surprised to see in RECREATION the claim that the wild pigeon has become extinct. If the writer of that statement should ever visit the coast of Oregon in August

he would become convinced that there are plenty left. I was at Pillamook bay last August and the wild pigeons were there by thousands, feeding on elder berries, which grow in abundance on this coast. They also came into the Willamette valley in large numbers in May and June. There are not so many here, however, as there were a few years ago. I do not think there is any law against shooting them at any season.

N. W. Smith, Lebanon, Ore.

ANSWER.

The bird you refer to is not the Eastern wild pigeon, or passenger pigeon, which was once abundant all over the Eastern and middle States. Your bird is the band-tail pigeon, *Columba fasciata*. It is a beautiful, interesting and innocent creature and its killing should be prohibited by law in all the coast States for at least 10 years.—EDITOR.

NATURAL HISTORY NOTES.

To-day I was watching an English sparrow trying to fly with a heavy load. It rose to an elevation of about 100 feet, and dropped its burden which, on examination, I found to be a live fledgling. The old bird did not again go near the young one. Is it customary for these birds to do this?

J. G. Stewart, Cedar Rapids, Ia.

This was probably the fledgling of some other bird. English sparrows eat the young of other birds, and possibly the young of their own kind from other nests; but it is not likely that they ever carry their own young about.—EDITOR.

I saw recently among a lot of English sparrows a bird which I at first thought was a canary. I shot it. Examination convinced me that it, too, was an English sparrow. Its back was light golden in color, the rest of its plumage was pure white. Has anyone else ever seen such a freak?

A friend found a living crow blackbird stapled to a fence post, and hanging head downward. As he was unable to draw the staples and release the poor bird, he killed it to end its misery.

Raymond Henshaw, Lyons, Kan.

There are a great many wild pigeons in the mountains of Western Texas and Southern New Mexico, flocks of several hundreds being frequently seen.

D. M. P., El Paso, Texas.

The bird you refer to is not the American passenger pigeon. It is the band tail pigeon, *Columba fasciata*.—EDITOR.

THE LEAGUE OF AMERICAN SPORTSMEN.

GENERAL OFFICERS

President, G. O. Shields, 23 W. 24th St., New York.

1st Vice-President, E. T. Seton, 80 West 40th St., New York.

2d Vice-President, W. T. Hornaday, 2969 Decatur Ave., Bedford Park, N. Y.

3d Vice-President, Dr. T. S. Palmer, Dept. of Agriculture, Washington, D. C.

4th Vice-President, A. A. Anderson, 80 West 40th St., New York.

5th Vice-President, Hon. W. A. Richards, General Land Office, Washington, D. C.

Secretary, A. F. Rice, 155 Pennington Ave., Passaic, N. J.

Treasurer, Austin Corbin, of the Corbin Banking Co., 192 Broadway, New York.

STATE DIVISIONS

ALASKA

Dr. E. M. Rininger, Chief Warden, Nome.

ARIZONA.

M. J. Foley, Chief Warden, Jerome.

ARKANSAS

W. R. Blocksom, Chief Warden, Eureka Springs.

CALIFORNIA.

Dr. David Starr Jordan, Chief Warden, Leland Stanford University.

COLORADO.

A. Whitehead, Chief Warden, 303 Tabor Building, Denver.

CONNECTICUT.

Hon. F. P. Sherwood, Chief Warden, Southport; Dr. H. L. Ross, Vice-Warden, Canaan; H. C. Went, Sec.-Treas., Bridgeport.

DISTRICT OF COLUMBIA.

C. H. Townsend, Chief Warden, U. S. Fish Commission.

FLORIDA.

W. W. K. Decker, Chief Warden, Tarpon Springs.

GEORGIA.

J. J. Doughty, Chief Warden, Augusta.

IDAHO.

L. A. Kerr, Chief Warden, Kendrick.

ILLINOIS.

M. D. Ewell, M.D., Chief Warden, 59 Clark St., Chicago; F. M. Taber, Vice Warden, 144 Kinzie St., Chicago; G. C. Davis, Sec.-Treas., 123 S. Central Ave., Austin.

INDIANA.

John J. Hildebrandt, Chief Warden, Logansport; T. J. Carter, Sec.-Treas., State House, Indianapolis.

IOWA.

Carl Quimby, Chief Warden, Des Moines; C. C. Proper, Sec.-Treas., Des Moines.

KANSAS.

O. B. Stocker, Chief Warden, Wichita.

KENTUCKY.

Geo. C. Long, Chief Warden, Hopkinsville.

MAINE.

Col. E. C. Farrington, Chief Warden, Augusta.

MARYLAND

J. E. Tylor, Chief Warden, Oxford.

MASSACHUSETTS.

Heman S. Fay, Chief Warden, Hazleton Block, Marlboro; J. E. Tweedy, Vice-Warden, North Attleboro; A. C. Lamson, Sec.-Treas., 194 Main St., Marlboro.

MICHIGAN.

J. Elmer Pratt, Chief Warden, Grand Rapids; R. S.

Woodliffe, Vice-Warden, Jackson; A. B. Richmond, Sec.-Treas., Grand Rapids.

MINNESOTA.

Dietrich Lange, Chief Warden, 2294 Commonwealth Ave., St Paul; H. A. Morgan, Vice-Warden, Albert Lea; Prof. O. T. Denny, Sec.-Treas., St. Paul.

MISSOURI.

Bryan Snyder, Chief Warden, 726 Central Bldg., St. Louis.

MONTANA.

Professor M. J. Elrod, Chief Warden, Missoula; Sidney M. Logan, Vice-Warden, Kalispell; R. A. Waagner, Sec.-Treas., Bozeman.

NEBRASKA.

Fred. E. Mockett, Chief Warden, Lincoln; P. O'Mahony, Sec.-Treas., Lincoln.

NEVADA.

Dr. W. H. Cavell, Chief Warden, Carson; Geo. W. Cowing, Sec.-Treas., Carson.

NEW HAMPSHIRE.

Dr. A. F. Barrett, Sentinel Bldg., Keene; Sidney Conant, Sec.-Treas., Keene.

NEW JERSEY.

Percy Johnson, Chief Warden, Bloomfield; Dr. W. S. Colfax, Vice Warden, Pompton Lakes; I. V. Dorland, Sec.-Treas., Arlington.

NEW MEXICO.

P. B. Otero, Chief Warden, Santa Fe.

NEW YORK.

John R. Fanning, Chief Warden, Powers' Bldg., Rochester; Col. R. E. Moss, Vice-Warden, Wallack's Theatre, New York City; Dr. C. C. Curtis, Sec.-Treas., Columbia College, New York City.

NORTH DAKOTA.

Dr. W. D. Jones, Chief Warden, Devil's Lake.

OHIO.

W. E. Gleason, Chief Warden, Mitchell Bldg., Cincinnati; A. C. Thatcher, Vice-Warden, Urbana.

OKLAHOMA.

W. M. Grant, Chief Warden, Oklahoma City.

ONTARIO.

C. A. Hammond, Chief Warden, Box 701, St. Thomas; D. L. Mells, Sec.-Treas., St. Thomas.

OREGON.

Robert F. Kelly, Chief Warden, Box 188, The Dalles; C. B. Cushing, Sec.-Treas., The Dalles.

PENNSYLVANIA.

C. F. Emerson, Chief Warden, 189 N. Perry St., Titusville; Hon. C. B. Penrose, Vice-Warden, 1720 Spruce St., Philadelphia.

RHODE ISLAND.

Zenas W. Bliss, Chief Warden, 49 Westminster St., Providence.

SOUTH CAROLINA.

C. F. Dill, Chief Warden, Greenville.

SOUTH DAKOTA.

D. C. Booth, Chief Warden, Spearfish; John C. Barber, Sec.-Treas., Lead.

TENNESSEE.

Hon. G. C. Martin, Chief Warden, Clarksville; Hon. Austin Peay, Jr., Sec.-Treas., Clarksville.

TEXAS.

Prof. S. W. Stanfield, Chief Warden, San Marcos; W. E. Heald, Sec.-Treas., San Angelo.

UTAH.

Hon. John Sharp, Chief Warden, Salt Lake City.

VERMONT.

S. C. White, Sec.-Treas., Woodstock.

VIRGINIA.

R. G. Bickford, Chief Warden, Newport News. C. O. Saville, Vice Warden, Richmond; M. D. Hart, Sec.-Treas., 1217 East Main St., Richmond.

WASHINGTON.

F. S. Merri'l, Chief Warden, Spokane; F. A. Pontius, Sec.-Treas., Seattle; Munro Wyckoff, Vice-Warden, Pt. Townsend.

WEST VIRGINIA.
E. F. Smith, Chief Warden, Hinton.
WISCONSIN.
Frank Kaufman, Chief Warden, Two Rivers; Dr. A. Gropper, Sec.-Treas., Milwaukee.
WYOMING.
H. E. Wadsworth, Chief Warden, Shoshone Agency; Frank Bond, Sec.-Treas., Cheyenne.

Applications for membership and orders for badges should be addressed to Arthur F. Rice, Secretary, 23 W. 24th St., New York.

LOCAL WARDENS

CONNECTICUT.

County.	Name of Warden.	Address.
Fairfield,	George B. Bliss.	2 Park Row, Stamford.
"	Harvey C. Went,	11 Park St., Bridgeport.
"	Samuel Waklee,	Box 373, Stratford.
Litchfield,	Dr. H. L. Ross,	P. O. Box 100, Canaan.
Middlesex,	Sandford Brainerd,	Ivoryton.
New Haven,	Wilbur E. Beach,	318 Chapel Street, New Haven.
"	D. J. Ryan,	188 Elizabeth St., Derby.

FLORIDA.

Brevard,	C. H. Racey,	Waveland.
----------	--------------	-----------

ILLINOIS.

Iroquois,	J. L. Peacock,	Sheldon.
Rock Island,	D. M. Slottard,	12th Ave and 17th St., Moline.

IOWA.

Clinton,	D. L. Pascol,	Grand Mound.
Pottawattamie,	Dr. C. Engel,	Crescent.

KANSAS.

Ness,	Frank Lake,	Ransom.
-------	-------------	---------

MASSACHUSETTS.

Norfolk,	Orlando McKenzie,	Norfolk.
"	J. J. Blick,	Wrentham.
"	S. W. Fuller,	East Milton.
Suffolk,	Capt. W. J. Stone,	4 Tremont Row, Boston.
Worcester,	B. H. Mosher,	Athol.

MICHIGAN.

Berrien,	W. A. Palmer,	Buchanan.
Cass,	Thomas Dewey,	Dowagiac.
Hillsdale,	C. A. Stone,	Hillsdale.
Kalamazoo,	C. E. Miller,	Augusta.
Lake,	John Frieber,	Peacock.
Ottawa,	W. H. Dunham,	Spencer.

NEBRASKA.

Hall,	E. C. Statler,	Grand Island
-------	----------------	--------------

NEW HAMPSHIRE.

Cheshire,	S. C. Ellis,	Keene.
Sullivan,	G. A. Blake,	Lempster.
"	J. W. Davidson,	Charlestown.

NEW JERSEY.

Hudson,	A. W. Letts,	51 Newark St., Hoboken
Mercer.	Edw. Vanderbilt,	Dentzville, Trenton.
"	Roland Mitchell,	739 Centre St., Trenton
"	F. C. Wright,	Trenton.
Monmouth.	Dory Hunt,	Wanaque.
Morris,	Joseph Pellet,	Pompton Plains.
"	Chas. W. Blake,	Dover.
"	Francis E. Cook,	Butler.
"	Calone Orr,	Hibernia.
Somerset,	G. E. Morris,	Somerville.
Sussex,	Isaac D. Williams,	Branchville.
Union,	A. H. Miller,	Cranford.
"	C. M. Hawkins,	Roselle.
Warren,	Jacob Young,	Phillipsburg.
"	Reuben Warner,	"

NEW YORK.

Albany,	C. D. Johnson,	Newtonville.
"	Kenneth E. Bender,	Albany.

County.	Name of Warden.	Address.
Allegany,	G. A. Thomas,	Belvidere.
Broome,	John Sullivan,	Sanitaria Springs
"	R. R. Mathewson,	Binghamton.
Cayuga,	H. M. Haskell,	Weedsport.
Chemung,	Fred Uhle,	Hendy Creek,
"	M. A. Baker,	Eimira.
Columbia,	A. B. Miller,	Jackson's Corners
Cortland,	James Edwards,	Cortland,
Dutchess,	A. B. Miller,	Jackson's Corners.
"	Chas. H. DeLong,	Pawling.
"	Jacob Tompkins,	Billings.
Erie,	Marvin H. Butler,	Morilla.
Essex,	W. H. Broughton,	Moriah.
Franklin,	Jas. Eccles,	St. Regis Falls.
Greene,	W. J. Soper,	Windham
Hamilton,	David Aird, Jr.,	Lake Pleasant.
Herkimer,	D. F. Sperry,	Old Forge.
Jefferson,	C. J. Smith,	Watertown.
"	A. C. Cornwall,	Alexandria Bay,
"	Jos. Northrup,	"
Livingston	M. De La Vergne,	Lakeville.
"	K. S. Chamberlain,	Mt. Morris.
"	Henry Skinner,	Springwater.
"	Dr J. W. Cowan,	Geneseo.
Montgomery,	Charles W. Scharf,	Canajoharie.
New York,	C. L. Meyer,	46 W B way, N.Y. City.
Oneida,	J. M. Scoville,	Clinton.
Onondaga,	James Lush,	Memphis.
Orange,	J. Hampton Kidd,	Newburgh.
"	Thomas Harris,	Port Jervis.
Orleans,	J. H. Fearby,	E. Shelby.
Oswego,	J. E. Manning,	154 West Utica St. Oswego.
Putnam,	H. L. Brady,	Mahopac Falls.
Queens,	Gerard Van Nostrand,	Flushing, L. I.
"	W. S. Mygrant,	46 Elton Street, Brooklyn.
"	P. A. Geepel,	473 Grand Ave., Astoria, L. I.
"	L. B. Drowne,	119 Somers Street, Brooklyn.
"	Lewis C. Att,	Broad Channel Hotel, Rockaway, L.I.
Richmond,	Lewis Morris,	Port Richmond.
St. Lawrence,	Dr. B. W. Severance,	Gouverneur.
"	A. N. Clark,	Sevey.
Schenectady,	J. W. Furnside,	Schenectady.
Schoharie,	O. E. Egen,	Sharon Springs.
Schuyler,	G. C. Fordham,	Watkins.
Suffolk,	F. J. Fellows,	Central Islip, L. I.
"	P. F. Tabor,	Orient, L. I.
Tioga,	Geo. Wood,	Owego.
Ulster,	M. A. DeVall,	The Corners.
"	Wm. S. Mead,	Woodstock.
Warren,	Geo. McEchron,	Glens Falls.
Washington,	C. L. Allen,	Sandy Hill.
"	J. E. Barber,	Dresden.
"	A. S. Temple,	Whitehall.
Westchester,	George Poth,	Pleasantville.
"	Chas. Seacor,	57 Pelham Road, New Rochelle.
"	M. W. Smith,	Croton Falls.
"	Ralph Gorham,	Mt. Kisco.
Yates,	B. L. Wren,	Penn Yan.
"	Seymour Poineer,	Branch Port.

OHIO.

Allen,	S. W. Knisely,	Lima.
Clark,	Fred C. Ross,	169 W. Main St., Springfield.
Cuyahoga,	A. W. Hitch,	161 Osborn St., Cleveland.
Erie,	David Sutton,	418 Jackson St., Sandusky
Franklin,	Brook L. Terry,	208 Woodward Av., Columbus.
Fulton,	L. C. Berry,	Swanton
Hamilton,	W. C. Rippey,	4465 Eastern Ave., Cincinnati.
Knox,	Grant Phillips,	Mt. Vernon.
Lorain,	T. J. Bates,	Elyria.
Muskingum,	Frank D. Abell,	Zanesville.
Ottawa,	Frank B. Shirley,	Lakeside.
Scioto,	J. F. Kelley,	Portsmouth.
Stark,	A. Dangeleisen,	Massillon.

OKLAHOMA.

Kiowa and Comanche Nation,	A. C. Cooper,	Ft. Sill.
----------------------------	---------------	-----------

PENNSYLVANIA.

County.	Name of Warden.	Address.
Allegheny,	S. H. Allen,	Natrona.
Beaver,	N. H. Covert,	Beaver Falls.
Bradford,	W. R. Keefer,	"
Butler,	Geo. B. Loop,	Sayre.
Cambria,	F. J. Forquer,	Murrinsville.
	W. H. Lambert,	720 Coleman Ave., Johnstown.
Cameron,	Harry Hemphill,	Emporium.
Carbon,	Asa D. Hontz,	East Mauch Chunk.
Clarion,	Isaac Keener,	New Bethlehem.
Clinton,	M. C. Kepler,	Renovo.
"	Geo. L. Kepler,	"
"	R. T. Antes,	Pine Station
Crawford,	Jasper Tillotson,	Tillotson.
"	Geo. T. Meyers,	Titusville.
"	J. B. Lamb,	Buel.
Cumberland,	J. C. Gill,	Mechanicsburg.
Delaware,	Waiter Lussan,	Ardmore.
Elk,	D. R. Lobaugh,	Ridgway.
Fayette,	Ely Cope,	Cadwallader.
Jefferson,	John Noll,	Sykesville.
Juniata,	Clifford Singer,	Oakland Mills.
"	Ezra Phillips,	McAlesterville.
Lackawanna,	Wm. Weir,	Moosic.
"	Wm. Major,	"
Lycoming,	Jas. J. Brennan,	Oval.
"	B. D. Kurtz,	Cammal.
McKean,	C. A. Duke,	Duke Center.
"	L. P. Fessenden,	Granere.
"	Wm. Holsinger,	Stickney.
Montgomery,	L. C. Parsons,	Academy.
Northumberland,	G. W. Roher,	505 Anthracite St., Shamokin.
Perry,	Samuel Sundy,	Lebo.
Potter,	Ira Murphy,	Coudersport.
"	Wiley Barrows,	Austin.
"	Chas. Barrows,	Austin.
Tioga,	E. B. Beaumont, Jr.,	Lawrenceville
"	G. H. Simmons,	Westfield.
Venango,	G. D. Benedict,	Pleasantville.
Warren,	F. P. Sweet,	Goodwill Hill.
"	Nelson Holmes,	Cornplanter.
Wyoming,	Cyrus Walter,	Tunkhannock.

TENNESSEE.

Madison,	H. T. Rushing,	Jackson.
Montgomery,	P. W. Humphrey,	Clarksville.
Robertson,	C. C. Bell,	Springfield.
Stewart,	John H. Lory,	Bear Spring.
Sumner,	W. G. Harris,	Gallatin.

UTAH.

Washington,	S. C. Goddard,	New Harmony.
"	J. A. Thornton,	Pinto.

VERMONT.

Essex,	H. S. Lund,	Granby.
Orleans,	E. G. Moulton,	Derby Line.
Rutland,	Wm. J. Liddle,	Box 281, Fair Haven
Windsor,	F. A. Tarbell,	West Bridgewater.

VIRGINIA.

Henrico,	W. J. Lynham,	412 W. Marshall, Richmond.
King & Queen,	R. D. Bates,	Newtown.
King William,	N. H. Montague,	Palls.
Louisa,	J. P. Harris,	Applegrove.
Mecklenburg,	J. H. Ogburn,	South Hill.
Smythe,	J. M. Hughes,	Chatham Hill.

WASHINGTON.

Okanogan,	James West,	Methow.
Stevens,	Jacob Martin,	Newport.
"	L. H. Lee,	Northport.
Yakima,	J. Brachmann,	N. Yakima.

WYOMING.

Carbon,	Kirk Dyer,	Medicine Bow.
Fremont,	Nelson Yarnall,	Dubois.
Laramie,	Martin Breither,	Cheyenne.
Uinta,	{ S. N. Leek, F. L. Peterson, }	Jackson.

LOCAL CHAPTERS.

Albert Lea, Minn.,	H. A. Morgan,	Rear Warden.
Anadarka, O. T.,	Bert Smith,	"
Angelica, N. Y.,	C. A. Lathrop,	"
Augusta, Mont.,	H. Sherman,	"
Austin, Minn.,	G. F. Baird,	"

Austin, Pa.,	W. S. Warner,	Rear Warden.
Boston, Mass.,	Capt. W. I. Stone,	"
Buffalo, N. Y.,	H. C. Gardiner,	"
Cammal, Pa.,	B. A. Ovenshire,	"
Champaign Co., O.	Hy. F. MacCracken	"
	Urbana,	"
Char'estown, N. H.,	W. M. Buswell,	"
Cheyenne, Wyo.,	J. Hennessy,	"
Choteau, Mont.,	G. A. Gorham,	"
Cincinnati, Ohio,	B. W. Morris,	"
Coudersport, Pa.,	I. L. Murphy,	"
Cresco, Iowa,	J. L. Platt,	"
Cross Village, Mich.,	Job Rohr,	"
Davis, W. Va.,	J. Heltzen,	"
Dowagiac, Mich.,	W. F. Hoyt,	"
East Mauch Chunk, Pa.,	E. F. Pry,	"
Evansville, Ind.,	J. M. Gilbert,	"
Fontanet, Ind.,	W. H. Perry,	"
Ft. Wayne, Ind.,	W. L. Waltemarth	"
Great Falls, Mont.,	J. M. Gaunt,	"
Heron Lake, Minn.,	K. C. Buckeye,	"
Holidays'g, Pa.,	T. J. Hemphill	"
Hopkinsville, Ky.,	Hunter Wood,	"
Indianapolis, Ind.,	Joseph E. Bell,	"
Jerome, Ariz.,	Dr. L. A. Hawkins,	"
Johnsonburg, Pa.,	W. J. Stebbins,	"
Kalispell, Mont.,	John Eakright,	"
Keene, N. H.,	F. P. Beedle,	"
Kingfisher, Okla.,	A. C. Ambrose,	"
Lake Co., Ind.,	Dr. R. C. Mackey,	"
Lawton, O. T.,	Marion Miller,	"
Lincoln, Neb.,	A. J. Sawyer	"
Logansport, Ind.,	E. B. McConnell,	"
Ludington, Mich.,	G. R. Cartier,	"
McElhattan, Pa.,	A. B. Winchester,	"
Mechanicsburg, Pa.,	Dr. J. H. Swartz,	"
Minturn, Colo.,	A. B. Walter,	"
Morgantown, W. Va.,	B. S. White,	"
New Albany, Ind.,	Dr. J. F. Weathers,	"
New Bethlehem, Pa.,	Isaac Keener,	"
Oklahoma City O. T.,	N. F. Gates,	"
Penn Yan, N. Y.,	Dr. H. R. Phillips,	"
Phillips, Wis.,	F. K. Randall,	"
Princeton, Ind.,	H. A. Yeager,	"
Reynoldsville, Pa.,	C. F. Hoegman,	"
Ridgway, Pa.,	T. J. Maxwell,	"
Rochester, N. H.,	Gustave Andreas,	"
" N. Y.,	C. H. McChesney	"
St. Paul, Minn.,	O. T. Denry,	"
St. Thomas, Ont.,	L. J. Hall,	"
Schenectady, N. Y.,	J. W. Furnside,	"
Seattle, Wash.,	M. Kelly,	"
Syracuse, N. Y.,	C. C. Truesdell,	"
Terre Haute, Ind.,	C. F. Thiede,	"
The Dalles, Ore.,	C. B. Cushing,	"
Two Harbors, Minn.,	T. D. Budd,	"
Walden, N. Y.,	J. W. Reid,	"
Wichita, Kas.,	Gerald Volk,	"
Winona, Minn.,	C. M. Morse,	"

LIFE MEMBERS OF THE LEAGUE.

Anderson, A. A.,	80 W. 40th St., New York City.
Beard, D. C.,	204 Amity St., Flushing, L. I.
Blackstone, Lorenzo,	Norwich, Conn.
Buzzacott, Francis F.,	Chicago, Ill.
Brown, J. Stanford,	489 Fifth Ave., New York City.
Butler, C. E.,	Jerome, Ariz.
Carey, Hon. H. W.,	Eastlake, Mich.
Carnegie, Andrew,	2d, Fernandina, Fla.
Carnegie, George,	Fernandina, Fla.
Carnegie, Morris,	Fernandina, Fla.
Corbin, Austin,	192 Broadway, New York City.
Dickinson, E. H.,	Moosehead Lake, Me.
Edgell, G. S.,	192 Broadway, New York City.
Ellis, W. D.,	136 W. 72d St., New York City.
Fearing, D. B.,	Newport, R. I.
Ferry, C. H.,	1720 Old Colony Bldg., Chicago, Ill.
Ferry, Mansfield,	183 Lincoln Park Boulevard, Chicago, Ill.
Fraser, A. V.,	478 Greenwich St., New York City.
Gilbert, Clinton,	2 Wall St., New York City.
Hudson, E. J.,	33 E. 35th St., Bayonne, N. J.
McClure, A. J.,	158 State St., Albany, N. Y.
Mershon, W. B.,	Saginaw, Mich.
Miller, F. G.,	108 Clinton St., Defiance, O.
Morton, Hon. Levi P.,	681 Fifth Ave., New York City.

Nesbitt, A. G., Maple St., Kingston, Pa.
 O'Connor, Col. J. C., 24 E. 33d St., New York City.
 Pierson, Gen. J. F., 20 W. 52d St., New York City.
 Prescott, A. L., 90 W. Broadway, New York City
 Rice, A. F., 155 Pennington Ave., Passaic, N. J.
 Seton, E. T., 80 W. 40th St., New York City.
 Seymour, J. H., 35 Wall St., New York City.
 Smith, E. B., Bourse Bldg., Philadelphia, Pa.
 Smith, W. H., Bryn Mawr, Pa.
 Thompson, J. Walter, Times Bldg., New York City.
 Towne, E. S., Care of National Blank Book Co., Holyoke, Mass.
 Underwood, W. L., 52 Fulton St., Boston, Mass.
 Valentine, Dr. W. A., 5 W. 35th St., New York City.
 H. Williams, Box 156, Butte, Mont.

DISCOUNTS TO LEAGUE MEMBERS.

The following firms have agreed to give members of the L. A. S. a discount of 2 per cent. to 10 per cent. on all goods bought of them. In ordering please give L. A. S. number:

Syracuse Arms Co., Syracuse, N. Y. Guns.
 Davenport Fire Arms Co., Norwich, Conn. Shot guns, rifles.
 Gundlach Optical Co., Rochester, N. Y. Photographic goods.
 Blair Camera Co., Rochester, N. Y. Photographic goods
 James Acheson, Talbot St., St. Thomas, Ontario, Sporting goods.

DON'T FAIL TO GO TO COLUMBUS.

The 6th annual meeting of the League will be held in Columbus, Ohio, Wednesday, February 10, 1904, and from present indications it will be the greatest and most successful gathering of any yet held. Chief Warden Gleason and Vice-Warden Thatcher, of the Ohio Division, together with the Hon. J. C. Porterfield, Chief Warden of the State Game and Fish Commission, are working like Trojans toward that end. These men are known throughout Ohio as thorough sportsmen and enthusiastic workers in the cause of game protection, and there is abundant reason to believe that the sportsmen of Ohio will respond generously and liberally to their efforts in this matter.

Every officer of the League should begin now to make arrangements to attend the 6th annual meeting. The 4th and 5th annual gatherings were great events and the men who attended them will tell you that all who were not there missed rare treats. No officer should deprive himself of the pleasure and the benefit to be derived from attending this 6th annual meeting, and I hope to see a greater gathering this year than ever before.

LEAGUE NOTES.

Local Warden Isaiah Vosburg, of Saranac Lake, N. Y., has been making a great deal of trouble for game law violators during the past year. Here is a list of convictions he has secured:

August 26th, Willard P. Jessup, New York city, fined \$85 and costs, Justice P. M.

Freeman, Tupper Lake, N. Y. (Sec. 33); August 29th, J. D. Alexander, Tupper Lake, N. Y., fined \$100 and costs, P. M. Freeman, Justice, Tupper Lake, N. Y. (Sec. 9); October 3d, Elmer Barton, Westville Center, N. Y., fined \$200 and costs, Justice R. J. Cunningham, Chasm Falls, N. Y. (Sec. 11); October 11th, John Soper, Malone, N. Y., fined \$100 and costs, Justice Emile La Rocque, Malone, N. Y. (Sec. 9).

In October last, John Soper and J. F. Walsh, of Malone, N. Y., concluded they would like some fresh venison and in order to make it as easy as possible, they put out their dogs to run the deer. This in violation of law. League Warden Vosburgh, of Saranac Lake, N. Y., was notified of the affair and went after the law breakers. He captured them both, and took them before Justice Larocque, who fined them \$100 each and trimmings. Soper and Walsh are probably still wishing they had done their hunting in a legal and sportsmanlike manner. Soper's number in the swine book is 940 and Walsh's is 941.

Game Warden H. Reif, of Seattle, Wash., L. A. S., No. 9151, has been after the game and fish law breakers in and about that city again and has lately landed several of them in court, where they have been properly punished. Reif is a zealous worker and has made trouble for a lot of lawbreakers since he has been in office. More power to his elbow!

TO MY DOG.

They sing of love, Virginia's love for Paul;
 Hero's for Greek Leander, whom the waves
 Brought to her feet lifeless beyond recall;
 Abelard's love for Heloise, their graves
 The mark of it; and these are passions all
 Of which the sentimental poet raves.
 But yet another love, and not the least,
 Where Cupid plays no part, yet hearts
 confide,
 Firm as the Heathen's worship for the East,
 Loyal and true it cometh to abide;
 A love that needeth neither oath nor priest,
 The love of beast for man and man for beast.

—Jean Rushmore, in Life.

Under a "sketchy little thing" exhibited by Jones there hangs a printed card which bears the words:

"Do not touch with canes or umbrellas."

An appreciative small boy added the following postscript:

"Take A. Axe."—Tit-Bits.

FORESTRY.

EDITED BY DR. B. E. FERNOW.

It takes 30 years to grow a tree and 30 minutes to cut it down and destroy it.

WHAT IS A FOREST?

Repetition is the secret of education. We must again and again present the same subject from different points of view, if we will have it understood and appreciated in all its bearings; especially when the people at large, the laymen, are to be educated in a professional subject, and to be made generally intelligent about it. Hence while the question of what forestry is has often been answered in RECREATION in various ways, there is still need of continuing to explain, as long as so many erroneous notions are afloat regarding this popular subject; as long as there are "city foresters"; as long as an indiscriminate "Woodman-spare-that-tree" sentiment dominates much of the writing in the public press; as long as such things can happen as the abolishment of our first forestry school, ostensibly because, forsooth, a committee of legislators knows better what forestry involves than the professional men do.

The word "forestry" is so modern that it was not yet recorded in the dictionary a quarter of a century ago. Even the word "forest," in its present sense, is of quite recent usage. Originally the word was written "voorst," and was used by the German tribes to denote the property set aside for the use of the king, or leader, of the tribe, the "Fuerst." That this property was naturally, to a great extent, woodlands had nothing to do with the meaning of the word. The main value of this property was the game, and as the owners could not use it for any other purpose, they merely reserved the right to the chase. Gradually this right to the chase became a royal prerogative, especially among the Normans; and the word "forest" became a legal term to denote a territory, including fields, woodlands, pastures, waters, settlements, and the people themselves living within its boundaries, on which the king had reserved the right to hunt for himself or his followers. In other words, a forest was what we would now call a game preserve. Special laws governed the people living within the preserve. The words "afforesting" and "disafforesting" were corresponding legal terms, which denoted the placing of districts under the forest ban and forest laws declaring them game preserves, or their release from such restrictions.

When we read, therefore, of the forests of Dean, of Windsor, of Epping or of

Sherwood, where Robin Hood, the forester bold, used to ply his trade, it is not the natural condition of being woodland, but the legal condition of being the king's game preserves that is meant. Foresters were nothing but gamekeepers, or police officers, to enforce the forest laws; or else, as in the case of Robin Hood, a man living on the preserve.

It was only gradually, and in England very lately, that the word forest began to assume the meaning of woodland, probably as the right to the chase became restricted to the woodland portion of the forest in its original sense.

Richardson's New Dictionary of 1846 defines a forest still as "a great and privileged wood or woody wilderness. Frenchmen have generally interpreted it as a place whereto access and entry are forbidden by the owner unto others; hence it seems that privileged fishing, or large waters, wherein none but the lords thereof could fish, were also termed 'forests.'"

It is also interesting to note that this mediæval conception and use of the term, which is naturally still recorded in our dictionaries, was called into use as late as 1862, when one of the dukes of Athole, in Scotland, instituted a lawsuit against the laird of Luke, his neighbor, to restrain him from killing deer on his own lands and to establish for the duke the right to enter the laird's lands for the purpose, in virtue of the duke's family holding from ancient times the position of "forester." The courts decided adversely on the ground of "innocuous dissuetude" of the forest lands.

Now the word forest is generally accepted as denoting a natural condition and as synonymous with woodland, but the lexicographers seem to be uncertain as to the distinction between woodland and forest.

In the German language there are also 2 words, namely, *Wald* and *Forst*. The first is the more general term, to denote merely the wooded condition, while the word *Forst* contains the idea that this woodland is placed under management or considered from the standpoint of its usefulness to man. We will do well to accept the same distinction and, when we speak of forest, have in mind that we are considering woodlands with reference to economic questions of man, an object of man's care, no matter whether natural, or wild, or planted, large or small. Then it becomes easy to see that forestry is nothing but that care of the woodlands or forests.

There are, however, 2 other conceptions or points of view that force themselves on us when using the word forest, and distinguish the forest from such woodlands as orchards, windbreaks, roadside plantings and parks.

A forest looks different from those other kinds of plantations, and its object is different. We recognize such a thing as forest conditions and forest purposes. These are important distinctions. Not any collection of trees, but a certain kind and characteristic form is a forest and certain objects are involved.

The first and foremost object of a forest is to supply us with wood material; it is the substance of the trees itself, not their fruit, as in the orchard; not their beauty, as in the park; not their shelter, as in the wind break; not their shade, as in the street trees, that constitute the primary object of this class of woodland, although incidentally all these other objects may also be served by it. Ultimately, then, a forest is nothing more nor less than a wood crop, just as a wheat field, while a beautiful object and perhaps a useful soil cover, is a food crop.

Only when the trees are cut and made into useful wood articles is the final object of a forest fulfilled; no matter what other objects it may have incidentally satisfied until harvest. Hence, if the State of New York withdraws from such use a large woodland area in the Adirondacks to subserve solely these secondary or incidental purpose, it is an economic mistake, which time and intelligent conception of rational economy will correct.

Sometimes and under certain conditions the shelter and soil cover which a forest furnishes may become more important than the wood material, namely, where steep slopes are to be protected against erosion and the water flow is to be regulated or the climate is to be ameliorated. These purposes can be attained without foregoing the main purpose of wood supply.

Again, on limited areas a forest may be set aside, as by the kings of old, as a game preserve and for pleasure purposes.

We may, therefore, recognize this last class as a luxury forest, the former as protection forest; but ultimately, in a well-regulated economic, industrial nation they must all become supply forests. Only the manner of management will vary wherever the former 2 objects are to be kept prominent.

While, then, the object of the wooded territory designates it as a forest, we also recognize forest conditions. The forest is not a mere collection of trees, but in order to fulfil its objects, the ideal conditions are a more or less exclusive occupancy with arborescent growth; a close stand of trees,

resulting in individual tree development unlike that produced in the open stand; and a more or less dense shading of the ground, which excludes largely the lower vegetation. By so much as these conditions are deficient, by so much does the forest fail to fulfil its economic functions as a source of useful material and as a factor in influencing climatic and soil conditions. Only because of the absence of better ones, do the woodlands in open stand, which characterize the arid regions, deserve the name of forest.

It is not merely wood which is required by man, but wood of certain description, certain qualities and sizes such as are fit to be cut into lumber, as boards, planks, joists, scantlings; into timber, as beams, sills and posts; or into bolts free from blemish, which can be advantageously manufactured into the thousand articles that are indispensable to human civilization. The trees which satisfy these requirements are those having a long, cylindrical shaft free of branches and of the resulting knots. Such trees are produced by the dense stand. The close neighbors deprive the lower branches early of sidelight, kill them, and rub off the dead branches. This forces the crown to reach up for light, and to put all growth energy into the bole instead of dissipating it into branch growth, such as is the proper thing for a shade tree or a lawn tree to develop.

Many of our virgin woodlands fail in this respect to satisfy the economic requirement of furnishing a suitable timber supply. Not only are large areas occupied by species of little usefulness, but they lack the ideal forest conditions which it is the function of the forester to create.

Visitor: So you were shipwrecked and came near starving?

Mariner: Yes, mum, and I had to eat a whisk broom and the sawdust out of a cushion.

Visitor: It must have been a terrible dose.

Mariner: Not so bad, mum. Yer see I had been used to eating health foods.—Chicago News.

As a sportsman I could not get along without RECREATION, as it gives so much valuable information about hunting grounds and sporting goods. I am much pleased at the way you roast the game hogs.

E. A. Schwartz, Alewife, Me.

A Philadelphia paper recently printed the following:

"Wanted—A young unmarried woman, without children, wants position as cook or housekeeper."

PURE AND IMPURE FOODS.

Edited by C. F. LANGWORTHY, PH.D.

Author of "On Citraconic, Itaconic and Mesaconic Acids," "Fish as Food," etc.

"What a Man Eats He Is."

PORK AS FOOD.

Statements are common to the effect that pork is not a fit food for man, various reasons being given, which in the majority of cases seem based more on prejudice than any scientific knowledge of the subject. Thus, it is often said that pork is indigestible. As it is comparatively rich in fat, it may take a little longer to digest than some other meats, but as far as diligent search shows there are no experiments on record which show it is less thoroughly digested than other flesh foods. Ham and bacon are accepted by many who do not believe in roast pork, yet the salt and smoke can do little except modify the flavor and keeping quality; so there is not much reason for such limitation. A careful review of the whole subject and of the experiments of different sorts which have been reported leads to the conclusion that pork is a valuable and useful food for man, provided it is of satisfactory quality, though the liking for it, as for other foods, is a matter of the personal equation.

Some statements recently made by Miss Emma J. Davenport, in a paper read before the Illinois Housekeepers' Conference, are of interest:

"There is a domestic animal which, in view of the fact that he was represented by over 8¼ millions of his kind in Chicago last year, possibly does not need a champion. This animal has developed with the Anglo-Saxon race, has enjoyed its prosperity, and to-day is a clean, well bred, wholesome domestic creature. I refer to the modern hog.

"There are people who claim that pork is not fit to eat because the hog is subject to some of the same diseases as man. What about tuberculous beef? The record, for 1901, of the chief representative of the United States Bureau of Animal Industry for the Chicago live stock market, furnished by Mr. Horine, statistician of the Chicago Union Stock Yards, shows the following results:

"Of cattle there were 1,810,155 inspections in the yard. Of these there were 2,202 rejections, or ¼ of one per cent. There were 1,748,573 *post mortem* inspections, of which 5,371 or 1-3 of one per cent of the carcasses were condemned. Of the inspected cattle, therefore, .42 of one per cent were condemned either on foot or after killing. Of hogs there were 6,547,370 inspections, of which there were 15,424, or ¼

of one per cent rejected on foot; and, of 7,121,509 *post mortem* inspections, 11,088, or 1-6 per cent rejected.

"Of hogs inspected, therefore, .30 of one per cent were condemned against .42 of one per cent of cattle; near 1-3 less. Not only this, ⅛ of one per cent of cattle against ¼ of one per cent hogs were condemned on foot; showing that disease in the hog is much more easily detected while alive, than in cattle; and this is further borne out by the fact that, of the *post mortem* examinations, but ½ as many carcasses of hogs were condemned as of cattle, or 1-6 of one per cent against 1-3 of one per cent.

"Besides, the average dressed carcass of a hog weighs 150 pounds, and that of beef 470 pounds, or a little over 3 times as much. Now if the proportion of diseased cattle is ½ times as great as of hogs, when we buy one pound of inspected meat the chances are over 4 times greater that it will be healthy, if it be pork, than if it be beef; yet no one, except a vegetarian, would think of saying that we should not eat beef.

"The tuberculin test and meat inspection have mitigated greatly the chances for diseased milk and meat being on the market; yet the only safety lies in insisting absolutely that milk shall come from herds which are frequently given the tuberculin test and where sanitary measures as to cleanliness and pure water are observed. Protection as to meat is always to cook it thoroughly, whatever it may be.

"These statistics show that pork is as wholesome and safe as beef.

"Comparing the composition of beef and pork, the following are averages of the whole carcass, not including the head: Beef: Waste, 17.6; water, 50.4; dry matter, 32.0; protein, 14.6; fat, 16.6; ash, 0.7 per cent; fuel value, 975 calories. Pork: Waste, 24.0; water, 32.0; dry matter, 53.8; protein, 10.8; fats, 40.5; ash, 2.4 per cent; fuel value, 2,045 calories a pound.

"Pork is particularly valuable as a food for energy, as it furnishes more than twice the amount that beef does. The adult does not require food for building up the body, except to replace the small waste; but he needs that which will give energy. Pork also contains the greater quantity of dry matter, and it is not deficient in protein. Pork is also to be recommended as a cheap food. It is especially cheap to the producer, and costs less per pound to the man who buys it. From quotations of the Chi-

cago markets, prices for dressed pork range from 5 cents to 8 cents a pound, and for beef, from 8 cents to 12 cents.

"In a list of dietaries furnishing approximately 0.28 pounds of protein and 3,500 calories of energy, the standard for a man at moderate muscular work, taken from the government bulletin on nutritive value and cost of foods, the cheapest diet given was bread and butter, pork and beans, at a cost of 13¾ cents."

IN MONARCHS' KITCHENS.

According to a recent writer, the German Emperor is disposed to be officious in the supervision of his kitchen. He has been known to make a special tour of inspection, under the guidance of a marshal of the court, and to harangue the scullions, or give them lessons in the art of making coffee. As a rule he gets his meals *en pension*, a regular sum per head being allotted for the board of the imperial family, and within these limits the cooks have a free hand. The chief cook is a German, and under him are a German and a Frenchman, although the use of the French language on the *menus* is strictly forbidden. The chef has to get through about 4-hundredweight of butcher's meat on ordinary days for the meals of the court. On great occasions he usually begins his preparations a week before, and calls in the services of the cooks at the other palaces, as well as the confectioners in *Unter den Linden*. William II. believes in dishes *en masse*. The joints appear in the dining saloon, and the cakes are frequently fashioned into the shape of temples, minarets and castles.

The *chef* in the household of the Czar is an Alsatian, an ex-soldier, who is paid a very high salary. He is an adept in the fabrication of appetizing Russian soups, which are much liked by Nicholas II; and he has a regular dictionary of recipes for the treatment of caviare. He has to endure the nuisance of having 2 or 3 Circasians always hovering about the kitchen on the lookout for suspicious underlings, and these gentry apply themselves to the task of tasting the imperial viands with greater zeal than the occasion demands. The Empress often conveys to the kitchen a request for a dainty dish to be prepared *a l'Anglais*; and apart from the national dishes, the composition of the imperial *menu en famille* is as much English as French.

The Emperor Francis Joseph is said to spend about \$250,000 a year on his table, although he himself is one of the most abstemious monarchs in Europe. The staff consists of half a hundred trained cooks,

equally divided as to sex, and a committee of the heads of each department is held on the occasion of a state banquet. All the carving is done in an apartment reserved for the purpose, to which the comestibles are conveyed from the kitchen. The custom of perquisites is more firmly established in the Austrian imperial kitchen than anywhere else in royal Europe.

At some of the smaller courts native *chefs* are preferred, as for example, in Rome, Madrid and Stockholm. At the Sublime Porte, Abdul Hamid formerly contented himself with French *chefs*, but after the visit of the German Emperor to Constantinople he engaged 3 German cooks, who assist him in dispensing the enormous daily sum of about \$5,000 on the pleasures of the table for his vast establishment. All the Sultan's personal dishes are prepared in silver vessels, and are sealed by the grand vizier before they leave the kitchen. The seal is broken in the presence of the monarch, and it is the duty of the chamberlain to taste the first mouthful if so commanded.

BOILED MEATS, POULTRY, FISH.

Fresh and salt meats and fish require different methods of cooking. When boiled, for instance, leg of mutton or fowls should be put into boiling water and allowed to boil rapidly about 10 minutes. Then the temperature should be lowered and the meat should be allowed to cook at simmering point, when little bubbles appear around the edge of the kettle, until it is done. The same rule applies to all lightly salted or smoked meats. Meats that are heavily salted may be put into cold water and allowed to come to the boiling point slowly. By this method much of the nutritive material is extracted before the surface of the meat is covered or sealed with an impervious layer of albumen, coagulated by the heat of the boiling water. Removing the excess of salt improves the flavor of the meat. When the boiling point is reached, the meats must only simmer or they will be grained and stringy. Fresh fish should always be put into boiling water, and then allowed only to simmer, as rapid boiling breaks the skin and separates the flesh and much is wasted. If it is put into cold water, much of the nitrogenous extractives and salts, which give flavor, will be dissolved before the fish begins to cook. Very salt fish is sometimes soaked in cold water before being cooked.

Nobody had any idea that germs were so good to eat until it was learned that more than 66 million of them are to be found in an adult oyster.—Kansas City Star.

BOOK NOTICES.

THE ANTHONY & SCOVILL ANNUAL.

The Anthony & Scovill Co., 122 Fifth Ave., New York, has issued the American Annual of Photography for 1904, and to persons who have been fortunate enough to see previous issues of this book, it is only necessary to say that the present one is fully up to the standard of the others. People who have not been reading the annual have a treat in store for them. The table of contents of the present volume is of itself an interesting study. It enumerates such articles as "A Flash Light Help," "A Plea For Sunshine," "Bromide Enlarging," "Carbon Printing," "Dark Room Lanterns," "Focal Plane Shutters," "Indian Photography," "Originality in Photography," and many others. One scarcely knows where to begin or where to stop these interesting, useful and instructive articles.

In addition to the text there are many reproductions of photographs that are gems of art, and any lover of photography who once picks up a copy of the annual for 1904 will regret to lay it down.

Notwithstanding all the treasures it contains this book sells for 75 cents.

MIGHTY INTERESTING BEARS.

"Bears I Have Met and Others" is the title of a book written by Allen Kelly, of California, and published by Drexel Biddle, of Philadelphia. This book contains the most thrilling collection of bear stories that has been brought together in any one volume, to my knowledge. The author must have spent years in digging up old hunters, and he has certainly struck pay dirt in most cases. If all these stories were true, it would mean that the California hills must have been alive with big grizzlies, all of which were walking around with chips on their shoulders.

The author pretends to believe that nearly all these big yarns are true, but evidently means to be polite to the men who told the stories. He knows it is not always safe to question the veracity of a Western man as long as he is walking about with a gun strapped on his hip. It is not necessary that a bear story should be true in order to be interesting. Some of these may be true, but they are all well told and any one of them is worth the entire price of the book. It sells at 50 cents, paper, and \$1, cloth.

The New York Zoological Society has issued a beautiful little book entitled "The New York Zoological Park" which con-

tains exquisite Albortype plates of elk, mule, deer, wild sheep, zebras, lions, tigers, bears, monkeys, cranes, flamingoes, etc. The pictures are 4 x 5½ inches in size, and are made from the choicest work of Mr. E. H. Sanborn, official photographer of the park.

The book sells at 25 cents, and is worth 4 times the price to any lover of wild animals. You can get a copy by addressing W. T. Hornaday, Zoological Park, New York City.

S. R. Stoddard, of Glens Falls, N. Y., has issued a new edition of his book, entitled "The Adirondacks, Illustrated." This has been for many years a standard book of reference and study for people who visit the Adirondacks and it is scarcely necessary to speak of it at length here. It is brimful of valuable information and as interesting as ever. Every person who has ever been in the Adirondacks, or who expects to go there in future, should have a copy. It is published by the author and sells at 25 cents a copy paper bound, 50 cents cloth.

Mr. A. H. O'Brien, editor of the Canada Law Journal, Ottawa, Ontario, has issued his yearly Digest of the Game and Fish Laws of Ontario. This is a neat little book of 44 pages, which must certainly prove useful to every sportsman who may contemplate a hunting or fishing trip to that Province. The book sells at 25 cents in paper covers, and at 50 cents in cloth. In writing for it, please mention RECREATION.

The Secretary of Agriculture, Washington, D. C., has issued a bulletin giving the text of the new Alaskan game law and full instructions as to the regulations adopted by the Agricultural Department for the enforcement of that law. Any person interested can get a copy of the bulletin by addressing Dr. T. S. Palmer, Department of Agriculture, Washington.

The work you are doing will live after you, and no sportsman who once reads your magazine can ever cease to be grateful to you for your noble work.

John T. Goolrick, Washington, D. C.

I am a reader of RECREATION and think it the best magazine published. I admire the way in which you roast the game hogs and hope you will continue.

Ray Pomont, Corona, S. Dak.

PUBLISHER'S NOTES.

HILDEBRANDT ADVERTISES.

The Enterprise Manufacturing Company, Akron, Ohio, has brought a suit against John J. Hildebrandt, of Logansport, Indiana, charging him with infringement of their patent on an artificial bait. They claim heavy damages and ask for an injunction restraining Hildebrandt from making and selling these baits in future. Hildebrandt secured a patent before beginning the manufacture of his bait, and this will no doubt stand good in the courts. The Enterprise people are not so enterprising as Hildebrandt is, and there is the rub. The Akron outfit has always declined to advertise in RECREATION. On the other hand, Hildebrandt used space in this magazine from the start, and naturally did a large business. In a recent letter to me he says, "I reaped large profits through advertising in your magazine; more than from all the others together."

If the Enterprise people had been as enterprising as they claim to be they would have had the trade of this country all supplied with artificial baits long before Hildebrandt got started.

A CONVENIENT OUTFIT.

Some 20 years ago I bought a heavy hunting knife, a thin bladed skinning knife and a steel to sharpen them on. Then I devised a scabbard in which to carry the 3 implements. I used this outfit until the scabbard was well nigh worn out, and then sent it to the Marble Safety Axe Co., Gladstone, Mich., with a request that they make me a new one like it. Mr. Marble liked the scheme, and asked permission to make up a line of outfits like this and put them on the market. I, of course, told him I should be glad to have him do so. Mr. Marble honored me by naming this the Coquina Outfit, for which I make to him my most profound salaam.

During all the years in which I hunted big game in the West, the South, and the Southwest, I found this combination of knives and steel most convenient and handy, and I think any sportsman who tries it will agree with me.

Messrs. Spratt's Patent benched, fed and fitted up the dogs at the Ladies' Kennel Association's Show held in Madison Square Garden, November 3-6; also the Long Island Kennel Club's Show, held in the Clermont Avenue Rink, Brooklyn, November 10-13; the Chicago Poultry, Pigeon and Pet Stock Show, 1st Regiment Armory, Wabash and 16th streets, Chicago, Ill., No-

vember 28-4; the N. J. Fanciers' Poultry, Pigeon and Pet Stock Show, New Auditorium, Orange street, Newark, N. J., December 1-5; the Poultry Show at Rutherford, N. J., December 10-12; and the Poultry Show at Hackensack, N. J., December 17-19.

They have a contract to pen, feed and fit up the Poultry Show to be held in New York City, January 4-9, and a number of other contracts pending.

The Blair Camera Co., Rochester, N. Y., has published a Christmas booklet giving a full description of Hawk Eye cameras. The various models of these are artistically and effectively illustrated, and the text describes them fully. A new Hawk Eye, No. 3, is described in this book for the first time. It makes $3\frac{1}{4}$ by $4\frac{1}{4}$ pictures and uses daylight loading films. The camera is neat, compact and handy, and is sure to prove popular. Another speciality of the Blair Camera Co. is the Stereo Hawk Eye, which is a light, handy camera, and which is provided with double lens and double rolls for making stereoscopic views. Every amateur photographer should have a copy of this book.

Office of G. G. Clough, Lawyer,
Corpus Christi, Texas.
Messrs. Schoverling, Daly & Gales,
New York City.

Dear Sirs:

Last summer I bought from F. Schorer, Galveston, 2 cans of New Green Walsrode that had gone through the Galveston storm of 1900. The cans were rusted to pieces, but the powder was O. K. I want 5 pounds New Green Walsrode. Where can I get it near here

Yours truly,
G. G. Clough.

Prevention is better than cure. Pure food and fresh air are essentials to this end, but not everyone seems to know that right underclothing is practically as important in our climate. The only right underclothing is wool, but the wool must be absolutely pure and the fabric of scientific weave, like Jaeger's, or else half the benefit is lost.

Prescott, Arizona.
West End Furniture Co.,
Williamsport, Pa.

Dear Sirs:

The sportsmen's cabinet has arrived, in perfect condition, and I am much pleased with it.

C. W. Manderfeld.

EDITOR'S CORNER.

NOW FOR A MILLION.

An editor's life is not all grief. It does not consist wholly of roasting people and being roasted. Occasionally someone comes in and asks an editor out to have a smile. Then again he sometimes gets a smile at his own desk. Here is one that came in the mail a few days ago:

Atlanta, Ga.

RECREATION, Magazine,
23 West 24th St, New York, N. Y.
Mr. G. O. Shields, Gen'l Mgr. and Editor.
Dear Sir,

I would like to write you a few lines informing you That i would like to write a Poem each month for your Magazine and let it go under the name as Poem's from a Southern Author from Way Down South. as I have composed a emense of Ghost Storys and Fairy Tales as i have never seen any such Story's of the Ye Olden Time written in a Magazine yet and would say that i can make it interesting in your Magazine for your reders I want to write for you the year round funny stories and Ghost Poems of the Ye Olden Times, i can write stories very comical and can make any body laugh their self to death, i will write reasonable monthly or yearly. So not as i think that i can improve your Magazine in Editorals but i can gurante that your readers will hunt for my stories every time. so give me a chance, i will write you a sample copy of my Southern pomes written From a Southern Dramatic Author, i will send sample copy and my price by request by you by Return Mail.

Yours very truly,

Dramatic Ghost Story Author.

I think I shall buy some of these poems and print them. I dislike to imagine a lot of my readers laughing themselves to death; but think of the gain to me! Let it be announced that a man in the Waldorf Castoria had died laughing at something he read in RECREATION. In a minute all the other people in the house would fall over the corpse in a struggle to get to the news stand; and so it would be everywhere. I expect to see my circulation go up to a million within 2 days after the appearance of the first one of these ghost story poems.

A BROTHER EDITOR APPROVES.

I am not fond of reprinting good things which brother writers may say of me, but I trust I may be pardoned for making a quotation from a recent issue of the Worcester, Mass., Gazette. The editor of that journal devotes a column to an ostensible defense of S. E. Hanson, of that city, whom I

roasted some months ago for having caught 300 pounds of fish in one day. In the course of his soothing remarks on behalf of the wounded Swede, the editor pays me a compliment that I can not forego the privilege of printing, not only for the satisfaction of my friends, but for the further stirring up of some other game and fish hogs who are busy telling their friends that nothing good can come out of RECREATION office.

The Gazette man, in speaking of Hanson's fishing exploit, says:

RECREATION is always lying in wait for things of this kind, and has a man in this city who informs the publisher of such cases as are deemed breaches of good breeding on the part of sportsmen. Mr. Shields, the editor and publisher, makes no bones of calling men hard names when they take an inordinate number of fish or kill more game than they can make use of. "Game hog" and "pot hunter" are among the terms which Mr. Shields marshals in a rhetoric so fiery that it is sufficient to scald the rivets off a steam boiler, to say nothing of starting the hirsute covering of his so-called "game hog."

A JUSTICE GUILTY.

Deputy Game Warden Phillips, of Duluth, Minn., went hunting in the Bowstring country last summer and found in one shack 30 sacks of deer and moose hair weighing altogether more than a ton. He also found 9 tanned deer skins and a half mounted head. He failed to find the wretches who killed the game, but it is hoped they may be apprehended later. The hair was burned and the hides confiscated.

On another trip, Phillips discovered, in the vicinity of Jessie lake, 50 miles North of Duluth, a lot of deer hides, deer heads and fresh venison. These were stored in and about the homes of W. S. Brown, a justice of the peace; Samuel Targenson, a constable; and John McDougall, chairman of the town board. These men were arrested, jacked up before a real justice, and the so called Justice Brown was fined \$50. The constable and the chairman of the town board were also found guilty, but for some reason their fines were remitted.

It seems that Robert Christie, the township treasurer, is a member of this band of law breakers, but it was impossible to get sufficient evidence against him at the time to convict him.

Brown's name goes down in the game hog register as No. 942, Targenson's as 943, and McDougall's as 944. Christie

should have a number, but I will postpone the registering of his name until Phillips gets a hook into him.

COUNTRY PAPER EXAGGERATES.

It was recently announced by a local paper that a judge of a certain court in Minnesota had killed 30 squirrels in a day. I wrote the judge for confirmation or denial of the report, and he replied that he and a friend were out 2 days and killed 26 squirrels, some 8 or 9 of which fell to the judge's gun. This illustrates in a marked degree the chronic offense of the average country newspaper editor of exaggerating reports of hunting and fishing trips. It is safe to say that half the statements of such trips sent to this office in the shape of newspaper clippings prove false on investigation. In the course of the letter to me denying the report the judge says: "The publication of the item was without my knowledge, and I regret that any publicity has been given the trip. The few days during the year when I can get away for fishing and hunting are enjoyed more because of the opportunity for healthful recreation than for the capture of game. While a well filled creel or game bag adds largely to the enjoyment of the trip, yet I am always thankful and content with the small portion that usually falls to my lot."

If country newspapers would only confine themselves to the truth in reporting the hunting and fishing trips of their readers it would save many a man the necessity of convicting the editor or the reporter of falsehood.

THE SHEEP MEN ARE HOT.

Certain stockmen and sheep owners in Wyoming, whose range has been curtailed by the creation of the Yellowstone Forest Reserve, have been working hard for several months past to induce President Roosevelt to rescind the order by which the reserve was created and throw the land open again for grazing purposes. These sheepmen have also demanded of the president the removal of Mr. A. A. Anderson from the position of superintendent of this reserve. They have made a great deal of noise themselves and have induced other people in the State to join them in howling; but from present indications their demands are not likely to be complied with by the president, and they should not be. The territory comprised within the limits of the Yellowstone Reserve is the natural home of the elk, the antelope and the mule deer, all of which have been greatly reduced in numbers and their feeding grounds seriously injured by the encroachments of the sheepmen. The limits of Yellowstone Park have proved insufficient for the preservation of these species of game and it

is just and proper that the United States Government should enlarge it. Pending such action by Congress, the president acted wisely in creating the Yellowstone Forest Reserve and it is hoped he may see fit to maintain it in its present size and shape.

A CHEAP EDITOR.

Albert, Arthur and Lyman Cooper, of Corunna, and William Robins, of Owosso, Mich., "all prominent citizens," according to a local newspaper, were arrested in August last by game warden Brewster, charged with dynamiting fish in the Schiwassaa river. The principal witness for the prosecution was J. Haines, of Schiwassaa. The dynamiters made him a present of a mess of fish, which he ate, and then reported the case to the game warden. After the evidence was all in, the jury went out at 10 o'clock at night and deliberated until 4 o'clock in the morning, when the members reported to the court that they would like to visit the scene of the dynamiting. They were driven 14 miles through a drenching rain, and on their return agreed on a verdict, finding the defendants guilty, whereupon Judge Patchel assessed a good, round fine against the "prominent citizens."

The people of Schiwassaa should feel heartily ashamed of an editor who calls dynamite fishermen "prominent citizens." The price these "prominent citizens" paid for their complimentary notice was probably a mess of fish. Verily, honors are cheap in Michigan.

Albert Cooper's number in the fish hog pen is 945, Arthur's 946, Lyman's 947, and William Robins' is 948.

MOVING THE PRAIRIE DOGS.

When the antelope range was first established in the New York Zoological Park a few prairie dogs were planted among the pronghorns, simply to enliven the landscape, but they enlivened it too much and became entirely too numerous in course of time; so Director Hornaday set his men to work to trap them and transfer them to the regular prairie dog village, which has a stone wall around it, running into the ground. The amateur trappers in the park exhausted their ingenuity on the little rodents without being able to capture many of them. Then a professional trapper was called in, and soon solved the problem.

He got a lot of empty barrels, knocked both heads out, set them over the prairie dog holes and filled the holes with loose sand. The dogs soon got tired of being corked up, dug out and let the sand go down below. This process stopped up the entrance to the holes. In other words, when a dog came out he pulled the hole out after him, and found himself barreled up. Then the trapper simply took a land-

ing net, dipped up the dog, carried him to the prairie dog town, pitched him over the fence, and there they all are to-day.

A RIGHTEOUS JUDGE.

I have before had occasion to commend Judge J. S. Huson, of the Probate Court, Grand Rapids, Mich., for the sledgehammer blows he is dealing offenders against the game and fish laws. He has recently made some new entries on his docket which are worthy the attention of every judicial officer in this country.

Here is the record:

August 1, 1903, Judge Huson fined Horace Lydick \$100 and costs, amounting to \$123.05, for killing a cow moose.

August 4, Dell Linden was fined \$1,000 and \$15 costs for having in possession 50 deer-skins, contrary to law.

July 2, William H. Brown was fined \$50 and costs, for killing 2 deer out of season.

July 15, W. D. Leelman was fined \$15 and costs for offering 3 black bass for sale.

If all judges would deal with offenders who are brought before them as Judge Huson does, the game wardens, constables and deputy sheriffs would soon be able to take a rest.

The Los Angeles Daily Herald gave an account some weeks ago of an investigation that was being made by the local fish and game protective association, of charges against a resident of that city to the effect that he was catching song birds in the trees about his house, with steel traps. The reporter sent out to write up the case had, no doubt, given the name and street address of this man, but the editor had evidently blue penciled the name, lest he should lose a subscriber.

Will some reader of RECREATION in Los Angeles please give me the name and address of this song bird trapper, and give me a full report as to what, if anything, was done with the case? The trapper may possibly be a subscriber to RECREATION, but that matters not. If I can learn who he is, I shall be glad to give him a scolding that will prevent him from renewing his subscription.

The Park Commissioners of this city have scored a victory against the bill board nuisance. A former Park Commissioner granted a permit to a certain advertising man to deface the fence surrounding the New York Library building, at Fifth avenue and 42d street. When Commissioner Wilcox was appointed he revoked this permit, and the mutilator of public walls went into court for redress. The case has recently been passed on by the Court of Appeals at Albany, and the action of Commissioner Wilcox is sustained. The unsightly and dis-

graceful advertisements that have defaced the public library fence for a year past must now come down. If the Legislatures of the various States would follow up this decision by passing laws prohibiting the erection of these ridiculous advertising fakes all over the country, the public would be grateful.

N. L. Hoyt, a wealthy grocer of Chicago, was arrested July 5th last, for shooting woodcock out of season, and 5 of the birds were found in his possession. He was taken before a justice of the peace in Evanston and fined \$15, this being the minimum penalty as fixed by law for the killing of one woodcock. I am informed that State Game Commissioner A. J. Lovejoy telegraphed the justice on the morning of the trial, asking that the fine be fixed at this small amount. The reason for this is supposed to be that Hoyt is a wealthy man and Lovejoy probably thought his influence might be valuable in some future election. If Hoyt had been a poor devil, the justice would no doubt have soaked him to the full limit and Lovejoy would have crowed over the victory. The law should not be twisted.

Joseph Beiter and William Arthur, 2 Johnstown, Pa., lawyers, have been given a dose of their own medicine. They went trout fishing in the close season for these fish last summer, and caught 28 in one day. State Fish Commissioner Meehan heard of the exploit, had warrants issued for the offenders, and a justice of the peace fined them \$10 for each fish, \$200 in all. They paid the fine and costs.

It is the business of a lawyer to expound the law to other people and collect pay for it. A lawyer is supposed to know all about game and fish laws, as well as others; and it is a great satisfaction to know that when a pair of these legal lights violated a plain, simple statute like that against the taking of trout at certain times they should have been required to pay the penalty.

In July last George Lucas, Britton Butler and Harry Vedeffer, of Winburne, Pa., were arrested by County Detective J. W. Rightnour, of Bellefonte, for dynamiting fish on Black Bear run. They were taken before Justice J. B. LaPorte, of Philipsburg, tried, found guilty and sentenced to pay a fine of \$100 each and costs of \$15.34, and to serve 100 days in jail. The dynamiters appealed their case to the county court, where the sentence of the Justice was confirmed and the pirates paid their fines.

Thus Justice LaPorte, Detective Rightnour and Harry Simla have earned the gratitude of all good people.

Lucas's number in the hog register is 949, Butler's 950 and Vedeffer's 951.

Dr. Barton W. Evermann, assistant in charge of Scientific Inquiry, U. S. Bureau of Fisheries, reports that he had excellent trout fishing in Alaska last summer, at several different places, particularly at Freshwater bay, Sitka, Klawock and Hunter bay. The most abundant trout in Alaska is the Dolly Varden. It was so abundant at Pablof falls, Freshwater bay, that Dr. Evermann was able to catch a number of large specimens in a few hours! The cutthroat trout and a new species of rainbow trout are also common and exceedingly gamey. Dr. Evermann promises to give the readers of RECREATION a fuller account of his angling in Alaskan waters.

July 23, 2 hunters, a short distance out of Wichita, Kan., were ostensibly hunting plover along the public highway. The local constable, who is a member of the L. A. S., thought that plover did not light on telegraph wires, investigated, found some doves in the wagon, and promptly arrested the men. He took them before the justice of the peace, who fined them \$25 apiece for their fun. They left 2 valuable guns as security. The State Secretary-Treasurer had caused the late changes in the game laws to be advertised extensively and the farmers were "next." Let the good work go on.

A hardware dealer in Dolgeville, N. Y., offered a prize in April last to the man who would take the biggest trout on the opening day of the season and deliver it at the hardware store. The prize was won by Joseph Kamps with a trout from Big Sprite creek that weighed 10¾ ounces. A certain smart Aleck of Dolgeville entered another trout which weighed 14 ounces, but it was suggested by some of the competitors that the fish was not big enough to register that weight. On examination the fish was found to contain 4 ounces of shot. It would have been a good scheme to have compelled Mr. Aleck to swallow those shot after they were taken from his trout.

J. N. Brown, of Dover, N. J., killed 3 wild ducks in July last at one pot shot, as they sat on the water. He was greatly elated over the result of his imaginary skill as a shooter, carried the birds down all the main streets and gleefully showed them to his friends. Game Warden Anson Decker heard of the incident, called on Mr. Brown and escorted him to the office of Justice J. H. Brown, where the duck shooter was informed that the State needed 62 of his dollars for the game protective fund. J. N.

plunked them down, and in future will probably wait until the legal season opens before he goes after ducks. His number in the game hog book is 952.

Eblom Karom, of Hartford, Conn., was recently arrested for killing song and insectivorous birds. He had in his possession 5 golden wing woodpeckers, one blue jay and 2 robins. The culprit was taken before Judge Garvan, of the Hartford police court, who soaked him to the extent of \$90 and trimmings—total, \$118.77. Karom paid the fine, and it will probably be a long time before he will make another series of Karom shots like those he made that morning. Game warden John E. Foote made the arrest, and says he is now looking for other bird hunters.

Karom is registered in the game hog book as No. 953.

James H. Mandigo, of Ogdensburgh, N. Y., attempted to ship 2 barrels of coarse fish to a dealer in this city some weeks ago, and when the barrels were delivered at the express office in Ogdensburgh, Game Warden E. H. Hazen, who happened to be on deck, thought he smelled game fish. He opened the barrels and found, neatly concealed among the bullheads, suckers, etc., 6 black bass. Mr. Hazen took Mr. Mandigo into court, introduced him to the blind goddess and a fine of \$50 and a sentence of 6 months' imprisonment were promptly pronounced against the offender.

Mandigo's number in the fish hog book is 954.

One J. L. McNitt, of Milroy, Pa., aided by a pack of hounds, caught a deer in August last and sold it to a party of hunters. Dr. Joseph Kalbfus, secretary of the State Game Commission, heard of the affair, went after McNitt, rounded him up, and took him before Justice J. R. Longwell, of Milroy, who fined McNitt \$125.

Hereafter when anyone asks McNitt if he is found of hunting deer he will probably just pronounce the last syllable of his name.

His full name is further recorded in the game hog book opposite the number 955.

Rev. Robert E. L. Craig, an Episcopal minister of Omaha, while out in Central Nebraska last spring holding religious services among the farmers, was arrested for shooting meadow larks and fined \$110. He was at the time a candidate for the rectorship of Trinity Cathedral, Omaha, but the good people of that congregation became so disgusted with him when they learned of his bird slaughter that they decided not to appoint him, and I understand he has left Omaha for some other field of labor. His number in the pig pen is 956.

Beer Keeps One Well

It is a noticeable fact that those who brew beer, and who drink what they want of it, are usually healthy men. You find no dyspeptics among them, no nervous wrecks, no wasted, fatless men.

And so in those countries where beer is the national beverage.

The reason is that beer is healthful. The malt and the hops are nerve foods. And the habit of drinking it keeps the body supplied with fluid to flush out the waste.

The weak, the nervous and sleepless must have it. Why isn't it better to drink it now, and keep from becoming so?

But drink pure beer — Schlitz Beer. There isn't enough good in impure beer to balance the harm in it.

Ask for the Brewery Bottling.



MACE STONE AND THE BEAR.

W. H. LIPPETTS.

It was from Mace Stone himself that I heard the particulars of his famous wrestling match with a bear. It was an unpremeditated affair on the part of Mace. Although he emerged from the encounter considerably the worse for wear, he often remarked,

"I larned that consarned critter a thing or 2 'bout back and squar holts that he didn't know afore."

Mace was so used to mixing truth with vivid imagination that it was sometimes hard to say just where the one began and the other ended.

"It was all along of that cussed carpenter," said Mace, when I had succeeded in loosening the floodgates of his eloquence. "That ornery critter was always getting into scrapes and then howlin' like a house afire for some one to get him out. You see it was this way: Me and the carpenter went out huntin' one day. We didn't know what we was huntin' for, but we was huntin' and by gum, we found something we wasn't lookin' for. We got over to Baldwin in time to catch the steamer *Ticonderoga*, and made a bargain with Captain Frank White to land us at what there was left of the old Horicon hotel pier at the foot of Black mountain.

"We picked our way ashore over the rotten planks some way or other, and turned off to the South so as to come out on the rocks back of Paradise bay. The carpenter was ahead. Him and me was travlin' slowly, not witchin' for much of anythin'. All of a sudden the carpenter went out of sight; I heard a thundering big thump and then a thundering big yell.

"That cuss had leather lungs I reckon. You could have heard him from one end of the lake to t'other. I knew there was trouble ahead, and not stopping to think I rushed forward and in 2 jerks of a lamb's tail I come down in the middle of as pretty a muss as any one not a durned fool could hope to see.

"There was the carpenter, flat on his back and over him a whoppin' big black b'ar. The b'ar was a-settin' on his haunches, lookin' kinder surprised at the lot of noise that cum frum such a small man as that carpenter. Well, I no sooner landed than that cussed skunk of a carpenter up and sloped, leavin' me to tackle the critter alone. Before I could ketch my breath, the b'ar fetched my arm a clip that sent my rifle sailin' out into the bay where the water was 20 foot deep. Then he caught me a slap aside of the head that made me see heavens' full of stars. By that time I had got my dander up, and we went at it hammer and tongs. Meanwhile the carpenter had shinned up a tree and was givin' me all sorts of advice.

"Give it to him, Mace," he yelled; 'soak him once for me.' Soak him; Great Scott! I'd avenge half a dollar to have soaked the carpenter just once about then. Talk about soakin' the b'ar; he had more science than Sullivan ever had. I managed to get out

my knife, but before I could use it, it was knocked out of my hand and over the bushes to keep company with my rifle in the bay.

"Yer gol darned fool," I shouted to the carpenter, 'come down out of that tree, pick up yer rifle and shoot the brute.'

"Your all right," says the carpenter, 'I'll stay where I am and let you finish him.'

"He was a miserable sort of a cuss, that carpenter. He had no more pluck in him than a 7 day old kitten. There he set up in the air, clutchin' the branch he was sittin' on and lookin' down on me and the b'ar as though it was a paid show and he had a reserved seat.

"All that time me and the b'ar was a-havin' it. We went round and round, and the dust flew. Sometimes I was on top and then the b'ar was. After cussin' and rastlin' awhile I got the critter where I wanted him, and by a sort of a double back-action twist I lifted and threw him clean over my head. He lit kinder stunned like. By the time he had got back his thinkin' faculties I ketched hold of the carpenter's rifle and sent a ball through the b'ar's ugly head.

"Then I looked at myself. I was a sight. When I started out in the mornin' I wore tolerably good lookin' clothers. Now my coat was clawed off my back and my pants was in ribbons. There wasn't enough thread in Ticonderoga to have mended that suit.

"The carpenter cum down from the tree and begun to make all sorts of comments about my appearance. He said I would make a good scarecrow and he'd hire me to stand in his corn lot the rest of the fall. He made me so consarned mad that I walked over to where he was standin' and fetched him a clip on the jaw that laid him out apparently as dead as a nit.

"I left, thinkin' I'd killed him for sure, but when I got back to Ti., there he was before me, and had sworn out a warrant, chargin' me with assault with intent to kill. I said he got the clip in the jaw from the b'ar in the beginnin' of the trouble, and then up and told them all how he had acted durin' the fight. The judge threw the case out of court.

He—Why are some girls so fond of bathing that they are on the beach all day, while others can't be induced to go near the water?

She—Oh, it's simply a matter of form.—Exchange.

10 cents.....	I drink,
10 drinks.....	I drunk,
I drunk.....	10 days.

—Life.

RECREATION is the best of books. I do not know how any one who loves hunting, fishing, or camping can afford to be without it.

G. E. Kinsley, Lanesboro, Pa.

THE EQUITABLE

HENRY B. HYDE
FOUNDER

J.W. ALEXANDER
PRESIDENT



J. H. HYDE
VICE PRESIDENT

1904

JANUARY

1

1 OF 2

events is sure—death or old age.

An adequate Endowment policy in the Equitable will make provision against both. It will protect your family if you die—or yourself—if you live.

Now is the time to make such provision. To-morrow may be too late.

To-day and every other day of 1904 is a good time to take life assurance

Vacancies For men of character to act as representatives.
Apply to GAGE E. TARBELL, 2ND Vice President.

For full information fill out this coupon, or write

THE EQUITABLE LIFE ASSURANCE SOCIETY of the United States
120 Broadway, New York Dept. No. 16

Please send me information regarding an Endowment for \$.....
if issued at..... years of age.

Name.....

Address

AMATEUR PHOTOGRAPHY.

"For sport the lens is better than the gun."

I wish to make this department of the utmost use to amateurs. I shall, therefore, be glad to answer any questions and to print any items sent me by practical amateurs relating to their experience in photography.

SOME TIPS ON REDUCTION.

In October RECREATION A. V. Woodcock asks for a formula for reducing over developed negatives, and is told to soak them in a 10 per cent solution of red prussiate of potash, and to examine the negative every few minutes to note the process of reduction. I trust that Mr. Woodcock is blessed with more than the usual amount of patience, else his task must prove wearisome. I can well imagine the beginner attempting to make use of this information, and I can foretell the result he will obtain, or rather will not obtain; for red prussiate of potash in solution, used alone, has no more effect as a reducer than so much water. Its only visible effect on the plate is to stain the film a deep yellow.

The various reducing solutions commonly in use may be divided into 3 classes, according to the manner in which they work. One class acts evenly all over the negative, removing density equally from the thick and the thin portions. The second class works unevenly, cutting deepest into the thin parts of the film and leaving the denser portions comparatively untouched, so that the result is to produce greater contrast in the negative. The third class produces exactly the opposite effect, thinning down the high lights and reducing the contrast. By keeping the idea of these 3 different classes in mind and using a solution of the proper sort when occasion arises, great improvement can be made in work.

Take, for illustration, a plate which has had the proper exposure. It came up nicely in the developer, but the latter may have been stronger than needed, or through lack of experience, development may have been carried too far. The whole plate looks thick and heavy and many of the finer details are buried under the dense deposit of silver. In order to make a print from this, a long exposure to light is required, and as a means of improvement it should be reduced. Although the relative values of the different densities have been somewhat altered from the normal by over development, the most satisfactory results will probably be obtained by simply removing an equal amount from the whole surface of the plate. To accomplish this, use a reducer of the first class, one which will act equally on both lights and shadows. For this I recommend the following, known as Bartlett's reducer:

Dissolve 15 grains perchloride of iron and 30 grains of citric acid in 16 ounces of water. Soak the plate in this a few minutes, rinse well and immerse in a clean hypo bath of the usual strength for fixing plates. Then wash well.

This reducer works well and evenly, the only objection to its use being that the reduction is visible only after the plate has been placed in the hypo bath, and on this account it is somewhat difficult to tell just how much the density of the plate has been changed. A few trials with waste plates will give one an idea of how long to soak the negative in the iron solution.

An over exposed plate needs a different treatment. I get the best results by developing it until it is dense and then reducing it, using a reducer of the second class, which will give an increase of contrast. In such cases I generally use the red prussiate of potash and hypo solution, commonly called Farmer's solution. To prepare this, dissolve 20 grains of red prussiate of potash (potassium ferricyanide) in one ounce of water. Dissolve separately $\frac{1}{2}$ ounce of hypo in 4 ounces of water. Add enough of the potash solution to the hypo to color the latter solution a pale yellow, and immerse the plate in this, having previously given it a thorough soaking. Rock the tray and watch the negative closely. If the action of the solution is slow, add a few drops more of the potash. After the solution has acted sufficiently wash the negative thoroughly.

Reduction with this solution should be carried on in weak light and the potash solution should be freshly mixed, as it undergoes a chemical change when exposed to light. This reducer sometimes works unevenly, reducing the plate in spots, and may also stain the film yellow if allowed to act too long; but by giving the plate a preliminary soaking and using a freshly mixed solution such trouble may be avoided.

Last comes the negative with too much contrast; the under exposed, over developed snapshot, the interior view or what not. For these it is best to use a solution of ammonium persulphate, freshly mixed, of a strength of, say, 15 grains to the ounce of water. Soak the negative well and apply the persulphate solution. A peculiarity in the action of this reducer is that it seems to work slowly at first, but gradually gathers headway and acts faster and faster; so the plate should be carefully watched, lest the reduction go too far. When reduction is sufficient it may be stopped by immersing the plate, after rinsing it, in a solution of sodium sulphite, say about 15 grains to each ounce of water. The sulphite solution checks the action of the reducer at once. After a few minutes' immersion the plate should be well rinsed

again, placed in an ordinary fixing bath a few moments and then well washed.

By the intelligent use of these methods an amateur may vastly improve the quality of his work; but I emphasize the fact that a correctly exposed and developed negative is always to be preferred to one which has been doctored.

C. M. Whitney, Bayonne, N. J.

CARD TRIES TO BE FUNNY.

I enclose a photo taken by Miss Pearl Cochran, at a distance of 150 feet. Miss Cochran lives at Wabana Lake, in Itaska County, Minn., 14 miles North of Grand Rapids. She and her father and some guests were on the lake in a launch when on turning a point of land they came in sight of these 2 moose, eating on a bog, and caught them just as they looked up.

H. S. Huson, Grand Rapids, Minn.

The photo you send is truly a remarkable picture. If it had been under the circumstances you describe, it would have proved of interest to all sportsmen and naturalists; but there is the rub. Please understand I am not questioning your statement in the least, nor any statement made by the young lady who took the picture; but it is possible that someone may be playing a joke on you, or on me. The photo looks as if it might have been made from a painting; but it may have been from life, as you say. If so, the young lady must have been at least 125 feet out in reckoning the distance; for at 150 feet from the camera the bull moose could not have been more than one inch high on the plate. I recently photographed my saddle horse at a distance of 12 feet, on a plate the same size as the one on which this moose picture was made, and he stands $4\frac{3}{4}$ inches high on the plate. The moose would be probably 3 feet taller than the horse, measuring from the hoofs to the point of his horns, and he stands $5\frac{1}{2}$ inches on the plate; so if this picture is from life he could not have been more than 15 feet to 20 feet from the camera.

If this picture was made from a painting, as I am inclined to believe, then the man who made the painting is a master artist and I should like to know who he is. It looks like the work of Landseer, or Seton, or Rungius. Now, my dear sir, I trust you will accept these questions in the kindly spirit in which they are put to you. There are many people who think it fun to get a joke on an editor, and many an editor has been caught in such traps. Will you kindly enlighten me further?

I beg pardon for having sent the photograph of the moose, or for having had anything to do with it. First, I am innocent of trying to practice any deception in

the matter. The story as reported to me I wrote you, thinking it would be of interest to the readers of RECREATION.. That, only, was my motive. I believed the story true, and the picture as true to nature.

On receipt of your letter, thinking I had made a blunder, I immediately drove out to Cochran's place and presented your letter to Miss Pearl Cochran. She was surprised that I did not know the origin of the picture. She informed me that it was taken from a label which came on a package of goods. The young lady is in no way to blame for the circulation of this story. It rests entirely with one John H. Card, of this place, who was stopping there as a guest, and who thought it funny to deceive me in this matter.

This man Card has in the past borne a bad reputation as to killing game out of season. I issued a warrant some time ago for his arrest, but the deputy sheriff, one Sawyer, who, by the way, has been discontinued as deputy sheriff, failed to do his duty, so Card escaped punishment. He has in the past killed both moose and deer for lumber camps.

H. S. Huson, Probate Judge,
Grand Rapids, Minn.

Since the foregoing was put in type I have learned that the drawing which Miss Cochran photographed was made by Carl Rungius.—EDITOR.

PLATE SOAKING.

A correspondent writes in RECREATION in regard to pin holes and dust. I emphasize what he said about using only the best brands of plates, but be sure to find out which really are the best, choosing brands used by professional photographers of good standing.

After dusting the plate, which must be done carefully, dust the plate holder as well. When cleaning my camera the other day I was surprised to see the quantity of dust and dirt that had collected within a short time in the inside folds of the bellows. The movement of focusing sets all this dust in motion, to settle on the plate during exposure.

It is not always advisable to soak the plates in water before developing; some brands of plates may stand it, but others, will not. The action of the developer is quite different if the plate is first soaked in water. The developer does not get down into the film in the same way as when poured over a dry plate. The water held in the film dilutes the developer and renders its action slower and less vigorous. I do not know of any plate makers who advise preliminary soaking.

The many inquiries for formulæ of developers of all kinds seen in the photographic

magazines indicate that many amateurs are hunting for the best developer. All the plate makers publish directions for handling their plates, in which are various formulæ for developers, any one of which you may be sure is the best in its class for that particular brand of plate. If it were not the best it would not be advised. To get the best results with plates, papers or any photographic supplies, follow strictly the directions given by the manufacturers.

R. L. Wadhams, Wilkesbarre, Pa.

HOW TO PHOTOGRAPH A YACHT.

The best position for the camera in relation to the yacht must be left to the judgment of the operator. A broadside view, or direct bow or stern, will not, as a rule, make a pleasing picture. What might be termed a three-quarter view will make the most pictorial photograph. Under ordinary circumstances, especially in bright weather, the white sails are rendered in almost the same tone gradation as the clouds. It is well, if possible, to secure some contrast, in order that the sail shall stand out against the sky in the print. The greatest contrasts will be obtained by having the sun at the back of the sails or in front of them. The position the boat occupies in the print is important. Unless at anchor, the boat should not occupy the center, and on no account should the position cause the cutting of the bowsprit, mizzen, or any part of the boat. The whole of the sails, rigging, spars, etc., should be included in the composition. This requires much care; but no picture of a yacht is worth taking unless it is complete.

A quick exposure will give a hard, unnatural, and lifeless appearance; a slower exposure will give the effect of motion and energy. The spray breaking over the bows will give life and action to the picture.—Exchange.

SNAP SHOTS.

I have been using all kinds of printing out paper. When I tone and wash my prints I put them on a ferrotype, and they always stick to it. How can sticking be prevented? What solution is best for Solio paper?

Edward Krivanek, Chicago, Ill.

ANSWER.

The difficulty you have experienced with prints sticking to the ferrotype plate may be due to the plates having become gummy. Wash plates thoroughly 3 or 4 times in boiling water, and apply paraffin solution, formula for which may be found in the Solio direction sheet. The trouble might also be due to using too much pressure when squeegeeing prints into contact. If toning by separate toning bath add $\frac{1}{2}$

ounce of Eastman Solio Hardener to each gallon of fixing bath. This would likely overcome the trouble encountered.—EDITOR.

In a recent issue of RECREATION I asked all such of my readers as are amateur photographers and who do their own developing and printing, to write me postal cards, stating that fact. Some hundreds of my good friends have taken the trouble to write letters in which they have answered that question, and in most cases they have also discussed other subjects. These letters do not, therefore, answer the purpose, and I must again request all my photographic readers who do their own chemical work to write me postal cards. I want these for a specific purpose and nothing else will answer.

Can you give me a good formula for a negative varnish?

W. T. Lovell, Kaw, Wyo.

ANSWER.

A good retouching varnish is made as follows:

Shellac	0.035 ounce
Sandarac	0.21 ounce
Mastic	0.21 ounce
Ether	2.7 fluid drams

2.7 fluid drams of pure benzole are added to the mixture after the resins have dissolved in the ether.—EDITOR.

I am a lover of the camera and through RECREATION have learned to be a good photographer. I have a trunk full of your magazines, and whenever I wish to find out any thing pertaining to photo work I know where to look for it. I have had many cameras. My favorite is the long focus Premo, 5x7. With it I do every kind of work and always get what I go after. I have never tried enlarging. Can it be done with my Premo? If so, how? Where can large sheets of developing paper be had for this work?

W. Klinefelt, Ashland, Wis.

The photograph printed on the front cover and again on page 339 of November RECREATION was made by Norman Pomeroy, of Lockport, New York. Unfortunately his name was not written on the back of the picture when he sent it to me, and accordingly when I came to publish it I had forgotten who made it. Friends who favor me with prints should invariably write their names and addresses on backs thereof, so that there may be no question as to giving proper credit.

To mend celluloid articles, wet the edge with acetic acid and press the pieces together for a short time.—Exchange.

Developing by Machine.

In a little more than a year of actual use the Kodak Developing Machine has demonstrated two facts—that the dark-room is unnecessary for film development—that better results can be obtained by machine than by hand.

The old theory that a negative can be successfully manipulated in development after the image has begun to appear has been exploded. If the exposure is over or under the range of the film or plate, no amount of "coddling" in the developer will save it. Its only hope lies in normal development to be followed after fixing by reduction or intensification.

Owing to the wide latitude allowed in exposure by our films, perfect negatives result from development for a certain length of time in a fixed strength of developer if the exposure has been anywhere near correct. And to correctly expose is not so difficult as the beginner imagines, there being a latitude of fully five points. For instance, if the correct exposure for a given subject were three seconds, any exposure of from one to five seconds would give a *perfect negative*. Whether "snap-shot" or "time exposure" makes no difference to the machine, and it handles both kinds of exposure on the same strip of film with perfect results.

Indeed, the superiority of machine developed negatives is so marked that a battery of Kodak Developing Machines operated by a water-motor, now does our work and does it better than could even the skilled and careful operators whom we have always employed. If the machine can give better average results than can be obtained by men who have done nothing for years except develop negatives, the amateur can certainly draw but one conclusion: that he must use it—not endeavor to compete with it.

Development of an entire roll takes but four or five minutes. The developer is then poured off; the film is rinsed; *taken out in daylight* and fixed in a tray or any convenient dish. A year's experience has brought to light the above very convenient method of fixing, cutting in half the time formerly required for operating the machine.

Just mix powders with water. That's your chemistry by the Kodak system. No weighing, no fussing, and every step by daylight. It's simple and economical, but most important of all it gives better pictures than the old way.

Kodak Developing Machines, \$2.00 to \$10.00.

EASTMAN KODAK CO.

Rochester, N. Y.

New Camera for Holidays

No. 3 Weno Hawk-Eye



POPULAR SIZE

POPULAR PRICE

EASY TO OPERATE

EVER READY

Makes picture $3\frac{1}{4} \times 4\frac{1}{4}$. Sells for \$8.00. Fitted with Automatic Shutter, Iris Diaphragm, Universal Focus Lens. It's **EVER READY**. Uses Perforated Daylight Loading Film, also Eastman Cartridge Film.

No. 3 Weno Hawk-Eye, \$8.00

Full description in Hawk-Eye Booklet.

BLAIR CAMERA CO.

Rochester, N. Y.

OIL PORTRAITS ON APPROVAL.

If you will send me a photo of yourself or a friend and state color of hair, eyes and complexion I will paint and send you on approval a miniature oil or pastel portrait.

Canvas 6x8 or 8x10 inches, \$10.00

Canvas 10x12 or 12x14 inches, \$15.00

Z. EMMONS, 58 West 104th St., New York.

Reference: Mr. G. O. Shields.

LANTERN SLIDES COLORED SKILLFULLY AND ARTISTICALLY

FOR
Lecturers, Teachers and others

I refer by permission to the Editor of RECREATION

MRS. C. B. SMITH

**The Ansonia, 74th St., & Broadway,
New York City.**

The manner in which you so thoroughly attend to business matters and look after the interests of your patrons is the surest sign that RECREATION stands at the top of the periodicals of its class.

J. H. Bailey, Pittsburg, Pa.

Accept my sincere thanks for the Harrington & Richardson hammerless revolver which I received as a premium. I consider myself well paid for what little time I spent in getting the subscriptions. RECREATION is the best magazine on earth for sportsmen.

Wm. Brown, Rochester, N. Y.

I received the gun you sent me for getting subscribers and am much pleased with it. I have also a Davenport gun, a premium for 9 subscriptions, which I value highly.

Clarence Calvert, Lancaster, Wis.

Inclosed please find \$1 for RECREATION for another year. It would be hard to get along without it.

A. H. Peckham, Omaha, Neb.

Allow me to congratulate you on the July issue of RECREATION. It is great. That bear story is a peach.

Don McGown, Des Moines, Ia.

I never go to bed for want of something to read, for each time I pick up RECREATION I find something new.

Fred L. Toft, So. Framingham, Mass.

**LEST YOU FORGET, IN A FIT OF ABERRATION,
I SAY IT AGAIN, PLEASE MENTION RECREATION.**

It's Not a Toss-Up



as to the quality of pictures made with a

KORONA Camera

IT'S ALL
IN THE
LENS

GUNDLACH-MANHATTAN OPTICAL CO., 730 So. Clinton Ave., Rochester, N. Y.

“THE KORONA and the FILM PACK”

is the title of an artistic
little folder which tells how
the **KORONA** can be
converted into a

Focusing Film Camera

by the use of the

FILM PACK ADAPTER

Do you want it? Your name, please.

Mention RECREATION.

"Century" Cameras.



"Century" Quality

is the result of twenty years' practical experience in Camera building. Is it any wonder, then, that **Perfection** is realized in the

"Century"?

Not only are Centurys perfect Plate Cameras, but they are also adapted for Daylight Kodak Film and

The New Film Pack.

Our complete Catalogue tells all about them. Can be had from your dealer or by mail direct.

CENTURY CAMERA CO.
Rochester, N. Y.

A Press Button Hunting Knife

Is one of the best articles a hunter ever carried

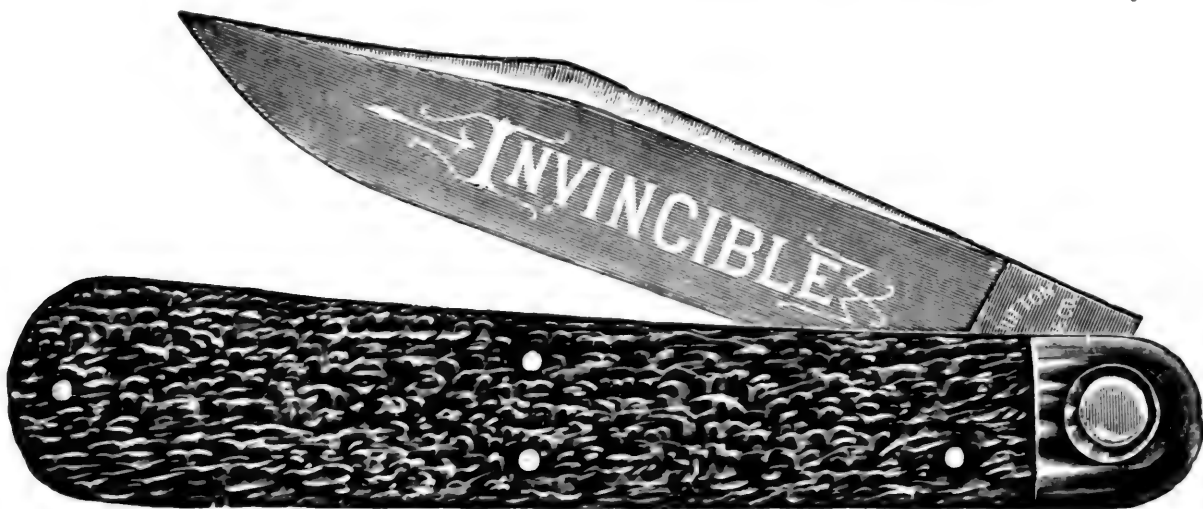

It has a 4 Inch Blade made of the Best Silver Steel

The knife cannot come open in your pocket. It cannot close on your hand when in use. It opens and closes only when

YOU PRESS THE BUTTON

If you once use one of these knives you will never use any other. You can get one as a premium for

3 YEARLY SUBSCRIPTIONS TO RECREATION

Sample Copies furnished on request.

OLD CLAM LOU.

FRANK FARNER.

She was out on the beach, on the glistening sands,
A dirty old crone, digging clams with her hands.

This was not at all strange, for the chief of her diet

Was clams; she must get them, or, anyway, try it.

As I sat down and watched her, the thought came to me,

"Of what earthly use can such poor creatures be?"

They are not as good scavengers even as crows,

And what they are good for, the Lord only knows.

"Perhaps she was sent that I plainly might see

And appreciate more what's expected of me."

Then I quickly decided that if such is the case,

She's a perfect success, and in the right place.

As she came to the shore I was seized with a hope

Of a chance to disprove that a Siwash hates soap.

With that object in view, I selected a cake

With a gaudy red wrapper, but of very poor make.

I stepped down to meet her, the soap in my hand,

She stolidly took it, sat down on the sand,

Tore off the red wrapper, took out what was in it,

And ate the whole piece in less than a minute.

Does a Siwash hate soap? Perhaps some of them do,

But that's not the case with this Old Clam Lou.

Souvenir Portfolio

containing
fine reproductions in halftone of

60 Prize Pictures

by the world's greatest photographers. 64 pages 9 x 12 inches on heavy plate paper, bound in art bristol with a photograph mounted on the cover, the whole tied with gold cord, making an elegant holiday album.

25 Cents

These pictures received the judges' awards in our \$3,000.00 contest just closed, and represent the highest attainments in pictorial photography. The reproductions, which are in the colors of the original photograph, are excellent in every respect, and form a collection that every lover of pictures, every one interested in photography, every student of art, will want to keep. The price, 25 cents, is only a fraction of the cost of the portfolio which contains also Ten Articles by famous Photographers on Ten Phases of Photography. There is no advertising matter in the books. We simply want to give every one an opportunity to see the excellent work which is being done by the foremost photographers of the world with our Photographic Lenses.

Alfred Stegitz' Grand Prize Picture

"5th Avenue in Winter"

is alone worth the price of the portfolio.

Send 25c. stamps or coin to Department V

Bausch & Lomb Optical Co.
ROCHESTER, N. Y.

Free:—I will give anybody sending me 1 subscription or renewal, any one of the articles named below:

Ideal Shell Closer, 10-12-16 gauge, sells for 50c.

Ideal Shell Loader, 10-12-16 gauge, sells for 50c.

Perfection Gun Oiler, can not spill when not in use, worth 50c.

Web Shot Shell Belt, 10-12-16 gauge, sells for 75c.

Henry B. Floyd, 723 Eighth St., N. W. Washington, D. C.

IN ANSWERING ADS PLEASE MENTION RECREATION.

For Golf & Tennis Players

"PRESTO! - CHANGE!"

ATTACHABLE EYEGLASS TEMPLES

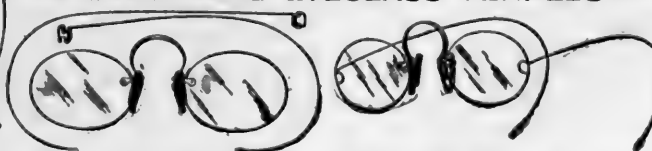

Eye Glasses into Spectacles. Spectacles into Eye Glasses

BE PROTECTED!

DON'T BREAK OR LOSE YOUR GLASSES IN EXERCISE, WIND AND STORM

Can be attached by anyone

Send thickness of lens when ordering by mail

Price in Nickel 50c. a pair.

Gilt 75c. a pair.

Gold Filled \$1 a pair.

Solid Gold \$2.50 a pair.

Established 1842 GALL & LEMBKE, Dept. C, 1 W. 42d St.

21 Union Sq., New York

Send for Circular

THE MEDICINE ARROW.

W. T. JONES.

About a year ago I visited, with Dr. R. E. Stewart and Mr. Charles Newell, of this place, an old Indian village at the mouth of Rock creek, on the Columbia river, where there are yet a few lodges of the once great Klickitat tribe.

Our purpose was to gather relics, arrow-heads, spearheads, stone pipes, mortars, pestles and other implements for the doctor's collection. We reached the village at 10 a. m. and found the Indians engaged in removing the remains of their dead ancestors from the cairns of rock on the mountainside, where they had rested for generations, to a little cemetery on a slope overlooking the broad Columbia.

The usual row raised by the dogs drew their attention and they greeted us cordially, for Mr. Newell, who has employed many of them on the range, was long since made a Tye, or chief, and is often called on to act as judge. His decisions are final and always respected; though from some of his rulings, as he recounted them to us, I should most certainly have appealed. Some of the Indians were digging the new graves, 6 or 8 feet long and 2½ to 3 feet wide, and nothing to go in them but pitiful little bundles of bones, mummified flesh and dust done up in rawhide.

What Tye Charlie says is law and gospel with the Klickitats, and after watching them a few minutes digging the tough gravel soil in the hot sun, he stopped them and said in Chinook,

"This way is good and all right for Boston men (Yankees) and King George men (English). They travel like the geese, ducks and cranes, all over the world. They die and one is buried here or there; but they are travelers, and when they come to Sah-a-le ty-ee ill-a-hee (heaven) they find each other easily. Klickitat Siwash are not so; they are born together, live together, fish, hunt, fight and die together, and should be buried together. Then when they come to heaven, Sah-a-lee tye Jesus will say, 'Kla-how-ye Klickatat till-a-cums (How are you, my Klickatat people), and will give you a good wide range, where there is plenty of bunch grass and deep streams, and where salmon will run the year round."

Without a question they selected one of the largest graves and widening it into a long trench, were soon placing the bundles in side by side. In moving one of the bundles some of the small bones dropped out and with them a stone arrowhead of perfect shape and peculiar material. I helped replace the bones, which I was told were those of Kam-ia-kan, a chief and an old time friend of Wa-ki-gas, one of the oldest men of the tribe, who was standing near I went to Wa-ki-gas and showing him the arrowhead asked if it had been buried for Kam-i-kan to use in heaven. He shook his head and said:

"Years ago, when I was a young man,

Kam-ia-kan, who was much older and a chief, led a band of young warriors to steal ponies from the Nez Perces, up on the Walla Walla. While hiding in the willows waiting to run off the pony band, a young Nez Perce squaw came to the river to comb her hair, using the placid surface of the water as a mirror. Before she was half done Kam-ia-kan decided that he needed another wife. He located the lodge where the squaw lived, and when his braves stampeded the pony herd that night, he rode to the door of the lodge, caught up the woman and swung her on his horse. Then he fled with her toward the mountains, but making a wide detour came back to the river, where he had hidden another pony in the willows. He had little fear of being pursued, for the Nez Perces were following the pony herd, which was being run off by his band.

"He stopped long enough to tie his captive on the led horse and to pull out the shaft of an arrow which had struck him in the short ribs as he turned from the lodge with his struggling captive. It was a medicine arrow, and using the painted and decorated shaft to urge on his horse he pushed down to the Columbia, which at that point is wide, but not rapid. He was feeling faint from loss of blood, but after untying the hands and feet of the squaw he forced his horses into the stream, and they swam for the other bank. The water, however, softened the blood-clot in his wound, and as they landed he fell fainting from his horse. His captive was a red skinned savage, but she was a woman; and like all her sisters, no matter of what color, she loved boldness in a wooer. Kam-ia-kan's scalp, which her people had many times risked their lives trying to get, his bow, quiver, ornaments and ponies would have made her the envied of the Nez Perce nation; but she was a woman. She bound up his wound and bathed his temples until he partly revived. Then helping him on his pony, she climbed up behind and sustained him until they reached his village on Rock creek.

"He is a brave warrior and I am a chief's daughter and proud of him," was all she said as she stood there a stranger among a strange people. "Yes," continued Wa-hi-gas, "this was the arrow that wounded him. It would not have hit him if he had made medicine for wife stealing, but he had made medicine only for horse stealing, and it was a narrow escape."

Now Wa-hi-gas, like Kimiakan and his captive bride, has gone to meet Sahale Tye Jesus, who I sincerely trust has judged them mercifully and given them the range Tye Charlie promised them.

"The window was open,

The curtain was drawn

A microbe flew in,

And our darling is gone."

—Chicago Record-Herald.

IN ANSWERING ADS PLEASE
MENTION RECREATION.

"Coffee-Heart"

THERE are 40,000 members of the Commercial Travellers Accident Association, and each member carries an identification card, in case of injury.

On two pages of this card are printed "Medical and Surgical Helps" by Dr. Terry, Surgeon-in-Chief of the Association.

Paragraph 4 says—"FOR VERTIGO OR DIZZINESS—Please remember that Coffee often produces it; therefore when you have congestion of the head, skin is yellow, or you feel heavy about the heart—stop using Coffee."

Insurance Companies now refuse policies for "Coffee-heart" just as they do for Consumption, Apoplexy or Morphine habit.

Because, with most people, Coffee weakens the heart, inflames the Spinal Cord, and arrests the digestion of food, by partially petrifying it in the stomach as alcohol would in a specimen jar.

"Postum" while correcting "Coffee-heart," builds up Brain and Nerve tissue.

Because,—Postum is made from the outer coats of Wheat, which are rich in Phosphate of Potash, the readiest Brain and Nerve food that Nature has provided.

These outer coats, (being sifted from Flour in the milling,) cannot in daily Bread, make good the ravages of Coffee.

But when Postum is boiled for 15 minutes the Phosphates are extracted from the wheat fibres, just as soup is extracted from bone and meat, ready for prompt assimilation and Nerve support.

It is easy to switch from Coffee, because "Postum" has the delicious flavor, and rich aroma of fine old Government Java.

A ten days trial shows wonderful results and costs little.

Postum

A DAY IN KINNEY COUNTY, TEXAS

I am a teacher by profession, but spend much time camping in the woods. In this climate camping is at all times delightful, even in midwinter. The air is clear and bracing and the temperature moderate.

Not long ago I went on a short trip to Blue Water hole. My outfit consisted of a horse and buggy, bedding and provisions for a 2 days' trip. My companion was a boy, Aleck Wickham, about 14 years old.

We left at 3.30 p. m. and arrived at Blue Water at 8 p. m., after a drive of 22 miles. We struck camp on the banks of the hole, which is about 20 yards wide and 250 yards long, fringed with pecan and sycamore trees. Having eaten supper and fed our horse we walked up the dry bed of the stream to try to find turkeys on their roost. The moon was shining bright and the trees were bare of foliage. We had not proceeded over 300 yards when a sudden "put, put," was heard 60 yards ahead, and out flew about 15 gobblers. I saw one still sitting in the tree; I fired and the turkey fell. We returned to camp and picked our gobbler.

I was out again by daybreak, among the trees toward which the turkeys had flown the night before. I could not see nor hear anything of them for a long time. At last I saw, in a small live oak, what appeared a board lodged in the tree, but which had the general outlines of a turkey. I decided to hold my gun in readiness to shoot if the least motion was discernible. I stood motionless until what appeared to be the tail moved the least bit. In less than a second I had fired, and out fell another large turkey.

Returning to camp I found Aleck had been fishing and had caught a few small perch and catfish. When the sun was about 2 hours high, I decided to try my luck at fishing. I put a trolling spoon on a small linen line and using an 18-foot cane rod, I made some spins across the water and found the silver trout* rising beautifully. The place was difficult to troll in on account of overhanging trees, but I kept Aleck busy stringing trout. I caught as many as he could well carry, one of the number being a 5½ pounder. Others pulled the scales at 3 and 4 pounds.

Leaving Aleck to stake this string near camp I walked ahead to a small lake 400 yards lower, taking along my shot gun loaded with buck shot. As I reached the edge of the woods opening on the lake a yearling deer jumped from the edge of the water where he had been drinking. Before I had time to think, my gun was at my shoulder and the deer was dead. It fell within 15 feet of where I first saw it. I made a few spins in the lower lake and landed more trout, making 16 in all. Carrying my fish and deer to camp, we put them in the buggy and started for home at 2 p. m., arriving in time to supply several families with fish for supper.

A. H. Horn, Brackettville, Texas.

*Large mouth black bass.—EDITOR.

AROUND DOTSERO.

I came to this place primarily to find relief from asthma. In this I have been successful, and, being an ardent lover of nature, have done nothing but hunt, fish and ramble over the hills and through the canyons.

The friend with whom I am staying says deer, elk and other game animals, are scarce now; but I think we can account for his opinion from the fact that he came to this section 15 or 18 years ago, when deer roamed at will over the river bottoms and elk could be seen in bands of 400 or 500. To my mind conditions are, at present, more favorable for genuine sport than they would be were deer and elk as plentiful as formerly, for in that case no skill at all would be required to secure them.

For elk one must now go 20 or 25 miles from Dotsero, though deer can be had within a mile of the village. Only a few days since 6 or 8 passed along a hill not half a mile distant, and in full view of the place. There are mountain sheep within 5 or 6 miles, but these the law protects at all times. Lions are scarce in the immediate vicinity. Have seen but few tracks this winter, one being exceptionally large. Two lions were taken near Gypsum, 7 miles above, some weeks ago.

Bear, like elk, are some distance away, though tracks were seen this fall on Onion ridge, 4 or 5 miles from here. About Deep lake are several bear, and one in particular has attracted attention. Men who have seen his tracks say they are the largest they have ever run across; indeed, bruin himself has been seen by several persons, who say the tracks are not deceptive.

Of smaller animals, wildcats and coyotes are numerous; beaver and otter scarce. Ducks, mostly mallards, are plentiful on Grand river, and a few geese were here a while. Grouse are abundant about Sweetwater lake, Coffee Pot and other places.

Trout abound in all the streams and lakes.

Colorado has strict game laws, but they are broken frequently, as are those of other States.

To one desiring recreation and sport, this part of the State offers special inducements. Here is Glenwood Springs, the Baden of America, one of the most noted watering places of the West. Of lakes there are many. Deep, Sweetwater, Marvine and Wappers are all typical mountain lakes, with clear, cold water, well stocked with trout, and comparatively easy of access. Then, too, there are many mountain streams, also filled with trout.

L. D. Gilmore, Dotsero, Colo.

"I'm glad to see that you respect your parents, Elmer," said the minister.

"I've got to. Either one of them could lick me with one hand."—Chicago News.



TRISCUIT

The New Cracker—

The highest achievement in food production in a century.

Triscuit—the *successful result* of years of experiment to make a cracker both light and short out of whole wheat with nothing taken from and nothing added to Nature's perfect whole wheat berry.

Triscuit are baked by electricity in the largest, best and cleanest Food Conservatory in the world.

Triscuit have the quality to exercise your teeth and the properties to build your teeth, and, being the perfect whole, to build the whole body.

Triscuit are used as Crackers, Bread, Toast, Wafers and with Soups, Preserves, Fruits, etc.

Heat before serving.

Ask your grocer for Triscuit. Send for sample.

The Natural Food Company, Niagara Falls, N. Y.



*"Buy China
and Glass Right"*

HIGGINS & SEITER

*FINE CHINA,
RICH CUT
GLASS.*

We illustrate our " $\frac{1}{4}$ Less than Elsewhere" policy by pricing these extra fine specimens of genuine American Cut Glass (see illustration) as follows:—
Celery Trays, full size as shown above, \$3.00. Fruit, salad or berry bowl \$3.00
For thousands of other offerings equally attractive see Catalogue No. 14 "U" with delicate tinted pictures of choicest china free to all interested in purchasing.
**WEST 21ST AND WEST 22D STREETS,
NEW YORK.**

Burnt Work—Something Great. To persons sending subscriptions to RECREATION through me, or sending them direct to the office to my credit, I will send the following prizes:

For 1 yearly subscription to RECREATION I will give a neat barrel match safe mounted on an oval back, both burned and decorated, equal in value to 75 cents.

For 2 yearly subscriptions to RECREATION I will give a 6 inch round picture frame burned and decorated with beautiful old fashioned poppies tinted with water colors. These would cost you \$1.25 at the least.

For 5 yearly subscriptions to RECREATION I will give either a round stool 14 inches high with round upholstered top or a square stool same height with square upholstered top. These would probably cost you \$7 or \$8 finished as I finish them with designs burned in the wood and leather.

E. A. King, Pleasant Prairie, Wis.

Long live RECREATION! What a pity it was not started 100 years ago, and what an abundance of game we could now find if it had been. I send you 5 more subscriptions, with cash.

R. M. Vardon, Toronto, Can.

My splendid premium, the hammerless Ithaca, is not only a beautiful gun, but a close, hard shooter. I thank you for your generosity and fair dealing.

A. J. Johnston, Wilkinsburg, Pa.

Do you think that constantly wearing a hat has a tendency to make a man bald?

No; but when a man is bald I've noticed that it has a tendency to make him constantly wear a hat.—Scissors.

I received the Al Vista camera you had sent me from the factory. Please accept my thanks. I have tried it, with remarkably good results.

P. B. Bacheller, W. Mt. Vernon, Me.

I don't know of any other sportsmen's publication that I consider worth as much praise as RECREATION. You come nearest of all in giving game hogs the right title.

Robert Elliott, Marlow, Can.

I have been a reader of RECREATION about 2 years. It is the best all around magazine I have ever read. I would not be without it.

W. D. Johnston, Marlboro, Mass.

I received the Marble pocket axe, and to say I am pleased with it is expressing it mildly. It is a beauty.

Karl Lenzler, Elyria, Ohio.

RECREATION has the right ring and should be read by everyone who loves nature.

Wm. S. Brackett, Peoria, Ill.

IN ANSWERING ADS PLEASE MENTION RECREATION.

DIAMONDS ON CREDIT



Turn Over A New Leaf.

WE HAVE A PAGE FOR YOU in our ledger, where we invite you to open a Confidential Charge Account for a Diamond. See how easy it is to do it under the **LOFTIS SYSTEM**: You simply make a selection of a Diamond, Watch or other article from the finest line of goods ever illustrated in a catalogue. Your selection will at once be sent to you for examination—if it is all that you anticipated and satisfactory in quality, pattern and price, you pay one-fifth and keep it, sending the balance to us in eight equal monthly payments. If after seeing the article you should decide not to buy, you have only to send it back to us at our expense. In any case you will be nothing out, for we pay all charges and assume all risk. Our Diamonds are of specially selected, fine quality and

at our prices, and on our easy terms, we secure a customer nineteen times out of twenty when we show goods. We do the largest Diamond and Watch business in the world—that explains everything. No competitor can meet us in prices, qualities, terms or liberal, progressive methods. Our house is just entering its fifty-sixth year in the Diamond and Jewelry business, during which time it has grown from a small shop, to the largest Diamond and Watch house in the world. We give a written guarantee with every Diamond—ask your local banker if it is good. He will turn to his book of Commercial Ratings and tell you that we stand very high in the

business world, and that anything we say or sign is good as gold, and that our representations may be accepted without question. In exchange of Diamonds; refund of monies paid, and all other features of a broad-gauge, liberal policy our house stands alone. There is one offer we have made for more than two years, and which has been accepted by thousands of customers, but no competitor has followed us in making it, for the reason that their smaller volume of business would not permit them to do business on a ten per cent margin. Here is the offer: Pay cash for any Diamond and we will give you a written agreement to refund all that you pay—less ten per cent, at any time within one year. You might under this offer pay \$50 for a Diamond; wear it a year then send it back to us and get \$45, making the cost of wearing a fine Diamond a whole year, less than ten cents per week. **A Charge Account** with us is a confidential matter. There are no vexatious delays or disagreeable preliminaries—everything is prompt, pleasant and guaranteed to be satisfactory. **Write today for our beautiful new catalog.**

LOFTIS BROS. & COMPANY

**Diamonds - Watches
Jewelry**

**Dept. A-82, 92 to 98 State St.,
CHICAGO, ILL.**

We have in this section black bears, deer, turkeys, squirrels and quails, also geese and ducks in winter. When I can find a hammer fitted for all purposes from driving a nail to cutting a steel rail or welding driving rods, I shall then hope to find a gun suitable for all our native game. My armament consists of a 22, a .303 Savage and a 38-40, while my shot gun is a 16 gauge pump. The latter I expected to lay aside when a 20 gauge is put on the market. The cost of this outfit need not exceed \$70 unless one is able to spend more for extra finish. I have a practical outfit with which to enjoy the sport of hunting. If I hunted for market I should use nothing but a 10 gauge double barrel gun, but all the game I kill in 5 years would not make me a game hog. I advise those who want to be posted on guns and ammunition to obtain the Savage and Remington catalogues and the Ideal hand book, and mix reading matter with horse sense. Steer clear of hoggishness, with RECREATION for your guide, and you will have a good time and a peaceful mind. Long may you live, dear editor, to carry on your noble work.

W. H. P., Greenville, Miss.

Ella—Where does Bella get her good looks from, her father or her mother?

Stella—From her father; he keeps a drug store.—The Pathfinder.

WANT A REEL?

You can get one for nothing.
Or at least for a few hours' work.

Send me

15 Yearly Subscriptions
to
RECREATION

and I will send you

A TALBOT REEL

Listed at \$20

Made by W. H. Talbot, Nevada, Mo.

This is one of the finest pieces of fishing tackle ever made. It is built like a gold watch. Equal to any Kentucky reel you ever saw.

**In Tournaments, Always a Victor
Among the Angler's Treasures, Always the Chief**

I have but a few of these reels in stock and this offer will be withdrawn as soon as the present supply is exhausted.

Sample copies of RECREATION for use in canvassing furnished on application.



H. J. TILLOTSON, M. D.
 The Master Specialist of Chicago, who Cures Varicocele,
 Hydrocele, and treats patients personally.
 Established 1880.
 (COPYRIGHTED)

Varicocele Hydrocele

**Cured to Stay Cured in 5 Days.
 No Cutting or Pain. Guaranteed
 Cure or Money Refunded.**

VARICOCELE. Under my treatment this insidious disease rapidly disappears. Pain ceases almost instantly. The stagnant blood is driven from the dilated veins and all soreness and swelling subsides. Every indication of Varicocele vanishes and in its stead comes the pleasure of perfect health. Many ailments are reflex, originating from other diseases. For instance, innumerable blood and nervous diseases result from poisonous taints in the system. Varicocele and Hydrocele, if neglected will undermine physical strength, depress the mental faculties, derange the nervous system, and ultimately produce complicated results. In treating diseases of men I always cure the effect as well as the cause. I desire that every person afflicted with these or allied diseases write me so I can explain my method of cure, which is safe and permanent. My consultation will cost you nothing, and my charges for a perfect cure will be reasonable and not more than you will be willing to pay for the benefits conferred.

Certainty of Cure is what you want. I give a legal guaranty to cure or refund your money. What I have done for others I can do for you. I can cure you at home.

Correspondence Confidential. One personal visit at my office is preferred, but if it is impossible for you to call, write me your condition fully, and you will receive in plain envelope a scientific and honest opinion of your case, Free of charge. **My home treatment is successful.** My books and lectures mailed free upon application.

H. J. TILLOTSON, M. D., 140 Tillotson Bldg, 84 Dearborn St., CHICAGO

Taxidermy Free to Subscribers of Recreation.

To any person sending me \$1 for 1 year's subscription to RECREATION I will mount free of charge any bird up to and including the size of a robin, blue jay, etc. For 2 subscriptions I will mount birds the size of screech owl, quail, etc. For 3 subscriptions I will mount birds the size of ruffed grouse. For 4 subscriptions, red tail hawk, wood duck, etc. For 5 subscriptions, brant, fish hawk, etc. For 6 subscriptions, great horned owl, etc. For 7 subscriptions, great blue heron, etc. For 10 subscriptions, swan, pelican, eagle, wild turkey, etc. For 15 subscriptions I will mount a deer head. Or any person sending me work to the amount of \$10 or more I will give RECREATION for one year. Prices given on application and all work guaranteed. The subscriber must pay express both ways. Here is a chance for sportsmen to decorate their dens with trophies free of cost.

A. W. Perrior, 316 E. Kennedy St., Syracuse, N. Y.

DO YOU WISH TO IMPROVE YOUR SHOOTING? IF IT IS AS GOOD AS IT CAN BE, DO YOU WISH TO KEEP IT SO? IN EITHER CASE, THE J. C. HAND TRAP WILL BRING WITHIN YOUR REACH THE FULL ADVANTAGE OF A SHOOTING RANGE. THESE TRAPS WILL SUCCESSFULLY THROW ANY OF THE CLAY TARGETS NOW IN USE, GIVING A LIFE LIKE REPRESENTATION OF A BIRD IN FLIGHT. I WILL SEND YOU A J. C. HAND TRAP FOR 5 YEARLY SUBSCRIPTIONS TO RECREATION. SEND IN YOUR CLUB NOW, AND IMPROVE ON YOUR SHOOTING.

Edgar—You wear pink all the time; I should like to see you in a lace-like white frock.

Ethel—How awfully—awfully sudden.—
 Detroit Free Press.

Keep Well and Happy with ORANGEINE

(POWDERS)

The Instant Help and Speedy Cure for "Grip," Colds, Neuralgia, Headache, Nervousness, Fatigue, Daily Ills.

Quickly offsets Exposure, Chill, Climatic Changes, etc.

UNIVERSAL EXPERIENCES.

Dr. C. L. Lawrence, Oakland, Cal., writes: "Have used \$50 worth of Orangeine this year in over 100 different directions. I would not do without it. It's ever ready and accomplishes all that is claimed for it."

Mr. H. M. Hoke, Harrisburg, Pa., private secretary to the attorney-general, says: "In my family the usefulness of Orangeine Powders multiplies right along."

Mrs. Mena Kemp Ogen, the talented authoress, Tipton, Ind., says: "I am glad to attest Orangeine's efficiency for my often infirmities, and its stimulating qualities when physically or mentally tired."

Professor O. B. Super, Dickinson College, Carlisle, Pa., says: "I have not had a cold for more than a year—thanks to Orangeine Powders."

"We use Orangeine Powders for everything and we think everything of it."—**Rev. A. C. McGilton**, Port Henry, N. Y.

Mr. J. W. Tillinghast, Grand Island, N. Y.: "Your powders have become indispensable in my family."

Mr. W. H. Forbes, Harrisburg, Pa.: "I expect to use Orangeine all my life. It saves me many a bad hour."

TRIAL PACKAGE FREE.—Orangeine is sold by druggists everywhere in 25c, 50c and \$1 packages. On receipt of request we will mail 10c trial package FREE with full directions, composition and description of its wide human influence. Address "Orangeine," Chicago, Ill.

Dr. H. M. Aspinwall, London, Eng.: "Please duplicate my last Orangeine order. I have given nearly all my powders to my patients, and as I have already told you, neither I nor my family can possibly do without it during the winter in this climate."

Mrs. A. H. Rogers, 62 State St., East Orange, N. J.: "I have tried Orangeine for Hay Fever and Bronchitis. The effect is wonderful, affording speedy relief, and finally a cure. For Neuralgia, I have found nothing better. I am thankful to know Orangeine, for it is the only remedy I have found to relieve and cure Hay Fever and Neuralgia."

Rev. J. Reynard Lawrence, Lancshoro, Mass.: "I count it a privilege to be able to call attention of people to Orangeine Powders."

Mr. P. A. Daly, Vesper Boat Club, Fairmount Park, Philadelphia, Pa.: "I am subject to very severe headaches—those which nearly drive one to suicide. Last night I had another such attack. I gave your powders a trial, and really in five minutes I was like a new man. The pain left me entirely. I feel it my duty to let you know the good Orangeine has done me."



Hon. Wong Kai Kah, Imperial Chinese Commissioner at the St. Louis Exposition, writes: "Orangeine Powders keep me always in condition to perform mental and physical effort; always effective; easy to take; produce no other than the effect desired."

My experience with Peters' shells has been such that I shall never use them again. While shooting at the trap recently I happened to look into the barrel of my gun and found a shell base stuck in the muzzle so tightly that I had to use a reamer to get it out. I am certain had I shot the gun in that condition it would have burst. I find a great deal of smoke comes out around the primers of Peters' shells. The shells are unevenly loaded and stick in the breach.

C. A. Duke, Duke Center, Pa.

I live in the Blue Ridge Mountains, at Monterey, Franklin county, Pa. We have quails and grouse in plenty, also gray squirrels, rabbits and some deer. We organized a hunting club of 20 members and go into camp for 15 days in November. In 1901 we got 2 5-point bucks and one doe, and as much smaller game as we could use in camp. We saw 11 deer in all. I use a .38 caliber rifle and it does good work. We are particular about the game laws and see that they are enforced.

H. J. Fitz, Charmain, Pa.

HYPNOTISM

Would you possess that strange mysterious power which charms and fascinates men and women, influence their thoughts, controls their desires and makes you supreme master of every situation? Life is full of alluring possibilities for those who master the secrets of hypnotic influence; for those who develop their magnetic powers. You can learn at home, cure diseases and bad habits without drugs, win the friendship and love of others, increase your income, gratify your ambitions, drive worry and trouble from your mind, improve your memory, overcome domestic difficulties, give the most thrilling entertainment ever witnessed and develop a wonderfully magnetic will power that will enable you to overcome all obstacles to your success. You can hypnotize people instantaneously,—quick as a flash,—put yourself or anyone else to sleep at any hour of the day or night—banish pain and suffering. Our free book tells you the secrets of this wonderful science. It explains exactly how you can use this power to better your condition in life. It is enthusiastically endorsed by ministers of the gospel, lawyers, doctors, business men and society women. It benefits everybody. It costs nothing. We give it away to advertise our college. Write for it to-day.

American College of Sciences, Dept.

104C, Rochester, N. Y.



WHAT IS CATARRH?

If You Have Any of the Following Symptoms Send Your Name and Address To-day.

Is your breath foul? Is your voice husky? Is your nose stopped? Do you snore at night? Do you sneeze a great deal? Do you have frequent pains in the forehead? Do you have pains across the eyes? Are you



losing your sense of smell? Is there a dropping in the throat? Are you losing your sense of taste? Are you gradually getting deaf? Do you hear buzzing sounds? Do you have ringing in the ears? Do you suffer with nausea of the stomach? Is there a constant bad taste in the mouth? Do you have a hacking cough? Do you cough at night? Do you take cold easily? If so, you have catarrh.

Catarrh is not only dangerous in this way, but it causes ulcerations, death and decay of bones, loss of thinking and reasoning power, kills ambition and energy, often causes loss of appetite, indigestion, dyspepsia, raw throat and reaches to general debility, idiocy and insanity. It needs attention at once. Cure



it with Gauss' Catarrh Cure. It is a quick, radical, permanent cure, because it rids the system of the poison germs that cause catarrh.

In order to prove to all who are suffering from this dangerous and loathsome disease that Gauss' Catarrh Cure will actually cure any case of catarrh quickly, I will send a trial package by mail free of all cost. Send us your name and address to-day and the treatment will be sent you by return mail. Try it. It will positively cure so that you will be welcomed instead of stunned by your friends. Write to-day, you may for get it to-morrow. C. E. GAUSS, 2016 Main St., Marshall, Mich.

FREE BOOK, WEAK MEN



My illustrated nature book on losses, varicocele, impotency, lame back, free, sealed, by mail. Much valuable advice and describes the new DR. SANDEN HERCULEX ELECTRIC BELT. Worn nights. No drugs. Current-soothing. Used by women also for rheumatic pains, etc. 5,000 cures 1932 established 30 years. Advice free.

DR. G. B. SANDEN,
1155 Broadway, N. Y.

SLEEP

Is Tired Nature's
Sweet Restorer

After a hard day's tramp, you must have
A Good Night's Rest
in order to fit you for the next day's work. Better to sleep on a good bed without your dinner, than to sip at a banquet and then sleep on the cold, hard, wet ground. You can get

A Recreation Camp Mattress

of rubber, with valve for inflating, made by the Pneumatic Mattress Co., and listed at \$18

For 10 Yearly Subscriptions to
RECREATION

Send for Sample Copies.

Address RECREATION, 23 W. 24th St., N.Y.

The axe which you sent me as a premium is a beauty. I can now understand the desire which led George Washington to cut down the cherry tree. I should like to do the same thing myself.

D. B. Wylie, Milwaukee, Wis.

No one could enjoy RECREATION more than I do. I never miss a chance of speaking a good word for it.

J. L. Starr, Stockton, Cal.

I thank you for the elegant Savage rifle received a short time ago. You are exceedingly liberal.

G. F. Baird, Austin, Minn.

PATENTS

promptly obtained OR NO FEE. Trade-Marks, Caveats, Copyrights and Labels registered. TWENTY YEARS' PRACTICE. Highest references. Send model, sketch or photo, for free report on patentability. All business confidential. **HAND-BOOK FREE.** Explains everything. Tells How to Obtain and Sell Patents, What Inventions Will Pay, How to Get a Partner, explains best mechanical movements, and contains 300 other subjects of importance to inventors. Address,

H. B. WILLSON & CO. Patent Attorneys
786 F Street, N. W., WASHINGTON, D. C.

"Ostermoor"

"I'm so Comfy"

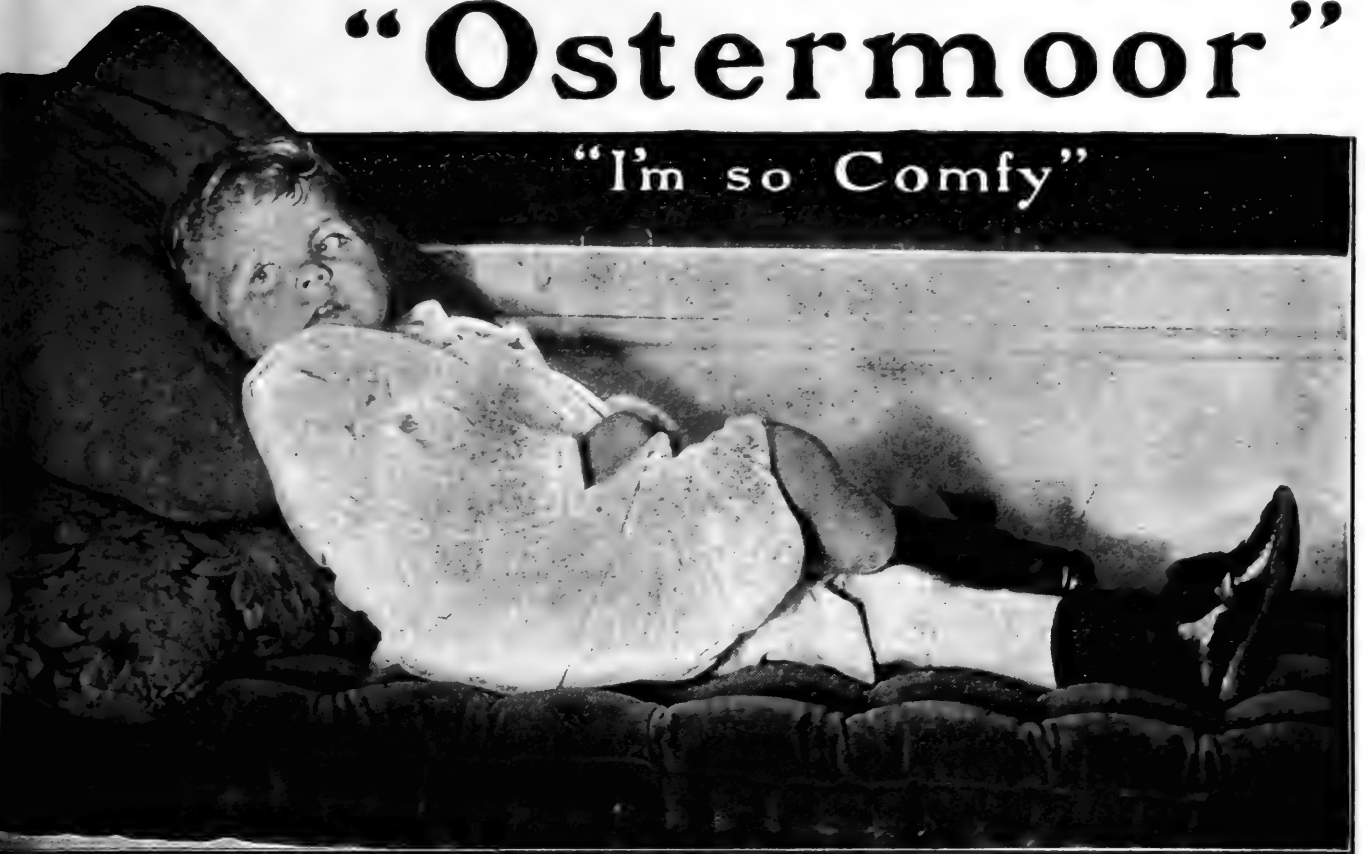

All these years we have advertised the OSTERMOOR Mattress and left the sale of our other products to our handsome book. A lady in Michigan writes us: "Your clever advertising has made me covet an OSTERMOOR Mattress, but unfortunately when I was married we bought an outfit of hair-stuffed ticks—too good to throw away; hardly good enough to keep. While visiting Mrs. —, of Detroit (one of your customers), I picked up a copy of your interesting book, 'The Test of Time,' and learned for the first time how many were the forms and how fair the prices of your

"Ostermoor" Cushions and Pillows

Among the many handsome and suggestive pictures I saw a window-seat idea that my husband says we *must* adopt. Please quote me a price on a cushion (like one on page 43), size of paper pattern enclosed." We wish you would

THE Ostermoor Patent Elastic Felt Mattress

2 feet 6 inches wide, 25 lbs. \$8.35

3 feet wide, 30 lbs. 10.00

3 feet 6 inches wide, 35 lbs. 11.70

4 feet wide, 40 lbs. 13.35

4 feet 6 inches wide, 45 lbs. 15.00

All 6 feet 3 inches long.

Express Charges Prepaid.

In two parts, 50 cents extra.
Special sizes at special prices.

Send for Book Mailed FREE

Our 96-page book, "The Test of Time," not only treats exhaustively the mattress question, but also describes and illustrates (with scores of pictures), OSTERMOOR Cushions and Pillows for Window Seats, Cozy Corners, Hall Benches and Easy Chairs; Boat Cushions, Carriage Cushions, Church Cushions—we have cushioned 25,000 churches. It is an encyclopaedia of comfort and good taste—may we send it? Your name on a postal will do. It costs us 25 cents, but you are welcome to it—even if you send from curiosity alone.

Our new book, "Built for Sleep" describes our complete line of Metal Bedsteads, Springs and Divans. Handsomely Illustrated. Mailed Free.



30 Nights' Free Trial

Sleep on the OSTERMOOR thirty nights free and if it is not even all you have hoped for, if you don't believe it to be the equal in cleanliness, durability and comfort of any \$50. hair mattress ever made, you can get your money back by return mail—"no questions asked."

Don't forget to send for the FREE book

Look Out! Dealers are trying to sell the "just as good kind." Ask to see the name "OSTERMOOR" and our trade-mark label, sewn on the end. Show them you can't and won't be fooled. It's not *Felt* if it's not an *Ostermoor*. Mattresses expressed, prepaid by us, same day check is received. Estimates on cushions and samples of coverings by return mail.

OSTERMOOR & COMPANY, 114 Elizabeth Street, New York

Canadian Agency: The Alaska Feather and Down Co., Ltd., Montreal

SOME RARE OPPORTUNITIES

These goods are all new, and will be shipped direct from factory. Prices named are those at which manufacturers and dealers usually sell. Here is a good chance to get

A Book, a Gun, a Camera
A Sleeping Bag, a Fishing Rod
A Reel, a Tent, } FREE OF COST

Subscriptions need not all be sent at once. They may be sent in installments as taken and credit will be given on account. When the required number is obtained the premium earned will be shipped.

TO ANY PERSON SENDING ME

TWO new yearly subscriptions to RECREATION at \$1 each, I will send a copy of *Hunting in the Great West*, cloth; or a Zar Camera, listed at \$1; or an Ingersoll Watch or Cyclometer, listed at \$1; or a Recreation Waterproof Match Box, made by W. L. Marble and listed at \$1; or a Shakespeare Revolution Bait listed at 75 cents; or a Laughlin Fountain Pen; or a dozen Trout Flies, assorted, listed at \$1; or a pair of Attachable Eyeglass Temples, gold-plated, made by Gall & Lembke; or one Rifle Wick Plug, made by Hemm & Woodward, Sidney, Ohio, 30 caliber to 50 caliber, or Shotgun Wick Plug, 20 gauge up to 10 gauge, or a pair of chrome tanned horsehide hunting and driving gloves, listed at \$1.50, made by J. P. Luther Glove Co.

THREE new subscriptions at \$1 each, a safety pocket ax, made by W. L. Marble and listed at \$2.50; or a dozen Bass Flies, assorted, listed at \$2; or a pair of Shotgun Wick Plugs made by Hemm & Woodward, Sidney, Ohio, 20 gauge to 10 gauge; or a Polished Buffalo Horn Gun Rack, made by E. W. Stiles; or a pair of gauntlets, for hunting and driving, ladies' size, listed at \$2.50, made by J. P. Luther Glove Co., or a Press Button Jack Knife, made by The Novelty Knife Co., and listed at \$1.

FOUR new subscriptions at \$1 each, an Ideal Hunting Knife, made by W. L. Marble and listed at \$2.50; or a 32 caliber, automatic double action revolver, made by Harrington & Richardson Arms Co.

FIVE new subscriptions at \$1 each, a copy of *Cruisings in the Cascades*, cloth; or a set of Nehring's Convertible Ampliscopes, listed at \$5.00; or an Ideal Hunting Knife made by W. L. Marble, and listed at \$3; or a pair of lock lever skates, made by Barney & Berry, listed at \$4.50; or a J C Hand trap made by the Mitchell Mfg. Co., listed at \$4.; or a Bristol Steel Fishing Rod, listed at \$6, or less; or a Yawman & Erbe Automatic Reel, listed at \$6 to \$9.

SIX new subscriptions at \$1 each, a Hawkeye Refrigerating Basket made by the Burlington Basket Co., or one dozen Eureka golf balls listed at \$4; or a Pocket Poco B 3¼x4¼, made by the Rochester Optical & Camera Co., listed at \$9.

SEVEN new subscriptions at \$1 each, a copy of *The Big Game of North America*, or of *The American Book of the Dog*, cloth, or one set Lakewood golf clubs, 5 in number, listing at \$5; or a series 11F Korona Camera, made by the Gundlach Optical Co., listed at \$10.

EIGHT new subscriptions at \$1 each. A series 1, 4x5, Korona Camera, made by the Gundlach Optical Co., listed at \$12. or an Acme single shot gun, made by the Davenport Arms Co., and listed at \$8.

TEN new subscriptions at \$1 each, a Cut-Glass Salad Bowl, made by Higgins & Seiter, and listed at \$4.50; or a Waterproof Wall Tent 7 x 7, made by Abercrombie & Fitch, and listed at \$8; or a Rough Rider rifle telescope, made by The Malcolm Rifle Sight Mfg. Co., and listed at \$12; or a Pneumatic Camp Mattress, listed at \$18.

TWELVE new subscriptions at \$1 each, a Peabody Carbine valued at \$12; or a Davenport Ejector Gun, listed at \$10., or a Cycle Poco No. 3, 4x5, made by the Rochester Optical & Camera Co., listed at \$15; or an 8 ft. folding canvas boat, made by the Life Saving Canvas Boat Co., listed at \$29.

FIFTEEN new subscriptions, \$1 each, a Shakespeare Reel, Silver Plated, listed at \$15; or a set of rabbit plates made by Higgins & Seiter, and listed at \$8, or a Field Glass made by Gall & Lembke; or a Kenwood Sleeping Bag, complete, with canvas cover, listed at \$16; or a Bulls-Eye rifle telescope, made by The Malcolm Rifle Sight Mfg. Co., and listed at \$16; or a 10 ft. special canvas boat, made by the Life Saving Canvas Boat Co., and listed at \$35; or a pair of horsehide hunting boots, listed at \$10.

TWENTY new subscriptions at \$1 each, a 14-karat small size Gold Hunting-case Watch, with Waltham Movement, listed at \$20; or an Elita single shot gun, made by the Davenport Arms Co., and listed at \$18., or an Acme Folding Canvas Boat, No. 1, Grade, A listed at \$27; or a Mullins Duck Boat, listed at \$20.

TWENTY-FIVE new subscriptions at \$1 each, A 4 x 5 Planatic lens, made by the Rochester Lens Co., and listed at \$45.

THIRTY new subscriptions at \$1 each, a Waterproof Tent, 14½ x 17, made by Abercrombie & Fitch, and listed at \$25.

FORTY new subscriptions at \$1 each, a Savage .303 Repeating Rifle; or a No. 10 Gun Cabinet, made by the West End Furniture Co., and listed at \$32.

FIFTY new subscriptions at \$1 each, a No. 20 Gun Cabinet, made by the West End Furniture Co., and listed at \$38.

TWO HUNDRED new subscriptions at \$1 each, a strictly first class upright piano, listed at \$750.

Address, **Recreation** 23 West 24th St.
New York

POND'S EXTRACT

The Old Family Doctor

Relieves:

Frost-bite
 Chilblains
 Chapped Hands
 Sore Throat
 Lameness Sprains
 Burns Scalds
 Cuts Bruises



Stops:

Toothache
 Earache
 Nose-bleed
 Hemorrhage
 Rheumatic Pains
 Neuralgic Pains
 ALL PAINS

A bottle of Pond's Extract in your home is a physician always within reach—one that has had 60 years experience curing pain. The genuine is sold *only* in sealed bottles with buff wrapper. Witch hazel is *not* the same as Pond's Extract.

Here are a few of the answers given by students of a Missionary College, at a recent examination:

What was the chief event of Solomon's reign?

He died.

Name some of the early Christian fathers.
 Jerome; Oxigen; Ambrosia.

What are the enduring remains of Egypt?
 Pyramids and obsequies.

In what Christian tenet did the Egyptians believe?

The immorality of the soul.

What was the religion of the Britons?

A strange and terrible one—that of the Dudes.

What caused the death of Cleopatra?

She bit a w-asp.

Where is the earth's climate the hottest?

Next the Creator.

What can you tell of Ben Jonson?

He survived Shakespeare in some respects.

What is the form of water drops?

Generally spherical, for reasons known only to the gracious Providence who makes them.

What is the spinal column?

Bones running all over the body; it is very dangerous.

Name a domestic animal useful for clothing, and describe its habits.

The ox—it don't have habits—it lives in a stable.

Of what is the surface of the earth composed?

Of dirt and people.

What is the function of the gastric juice?

To digest the stomach.

Define interloper.

One who runs away to get married.

Define flinch and give a sentence.

Flinch is to shrink. Flannels flinch when washed.

Name 12 animals of the arctic zone.

Six polar bears and 6 seals.

Define vengeance, and give a sentence using the word.

Vengeance is a mean, spiteful desire to pay back. "Vengeance is mine and I will repay, saith the Lord."

Define hireling.

One who is bribed. Teachers are hirelings of the government.

What is the chief industry of Austria?

Gathering ostrich feathers.—*Life*.

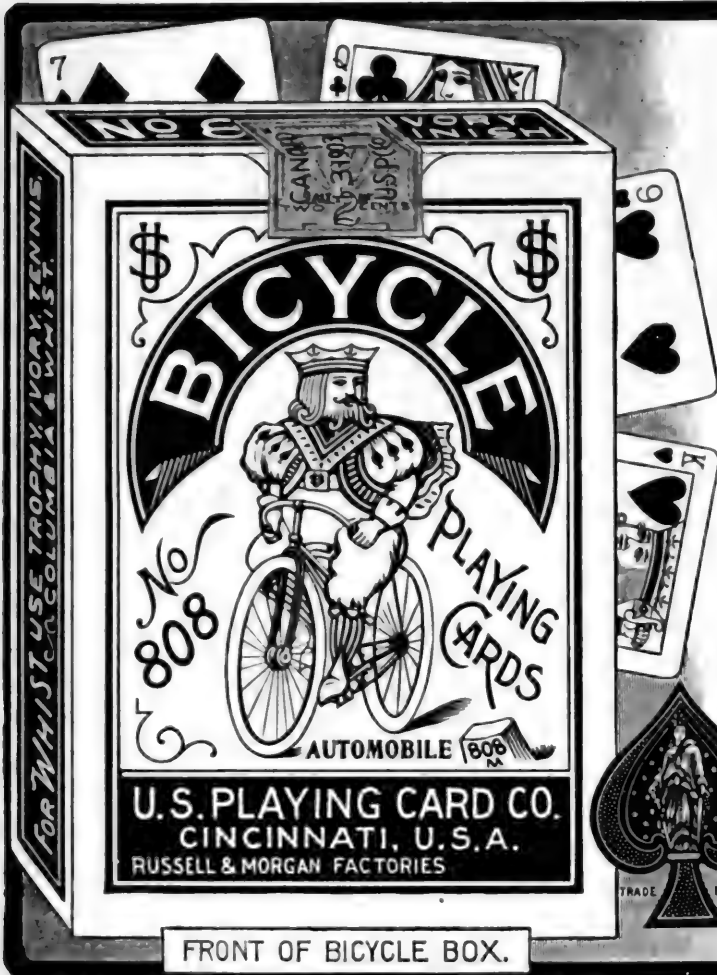

FRONT OF BICYCLE BOX.

Bicycle Cards, High in quality, Low in price.

Favorites from Greenland to Tasmania—because the best. More sold than all other brands combined. Dealers everywhere have them.

The U. S. Playing Card Co.
Cincinnati, U. S. A.

HOYLE for 10c. In stamps—128 pages. Address Dept. 23

For Duplicate Whist, best of card games, use Faine's Trays Lessons free with each set of trays. Write for particulars.

A friend who owns a 38-72 box magazine black powder gun desired to use 2 miniature load in the gun, so bought a 38 mould and made some bullets. Though 14 grains would have been plenty, he filled his shells with 72 grains of smokeless 30 caliber powder. The result was that a shell burst at the breech, throwing powder and brass in his face. He was under a doctor's care 4 days. The gun was slightly damaged. I had advised him not to shoot the charge, as I expected it to burst the barrels.

G. L. Manon, Post Falls, Idaho.

I thank you for the Harrington & Richardson shot gun sent me as a premium for a club of subscriptions to RECREATION. I have tried the weapon and found it all that it is claimed.

W. S. Heath, Binghamton, N. Y.

RECREATION is the best magazine published. Just keep on roasting the fish and game hogs wherever you get a whack at them. Jacob Young, Phillipsburg, N. J.

RECREATION is improving all the time. Alex. C. Wade, Jr., Birmingham, Ala.

No. 58



HERE IS A KNIFE Men Love So Much They Hate to Throw an Old Handle Away
It Was Teddy's Camp Knife!

No. 58. Cut is exact size; ebony handle, 3 blades, German Silver ends. The long blade is for rough or fine work; the medium blade is as thin as a razor. Price, postpaid, \$1.60 for \$5.

The lower cut is "Chauncey Depew's pet," has three blades (one is a file). Handle is choicest selected pearl; German silver back and ends. Price in chamol's case, \$1.50 postpaid. Same knife, 2 blade, \$1; plainer finish, 3 blade, same quality, \$1; smaller 2 blade, for lady, 75 cents. Illustrated 80-page List free, and "How to Use a Razor."

Maher & Grosh Co.
74 1/2 STREET, TOLEDO, O.



AN OLD MAN'S FRIEND.

MRS. FRANK C. ROBINSON.

Only a dog? He's my friend!
A friend that is faithful and true.
One whose affection I've tested,
In pleasure and sorrow too.

Only a brute, did you say?
He's no more of a brute, friend, than you.
Look into that face so honest,
And those eyes, straightforward and true.

We've had him since he was a pup,
Just seven weeks old to a day;
And though he's unable to speak,
He understands all that we say.

You doubt it? Well, sir, I'll prove it!
There's my wife down the road to the
right;
You can't make her hear by calling,
She's just disappearing from sight.

Le Roy, old fellow, come here, sir!
Mother has gone down to see Kate.
Go! bring her back, I want her;
And remember, you must shut the gate.

He is off! Now watch him and tell me,
Can you close the gate better than that?
Will he come back, you ask, without
mother?
That he will not, I'll wager my hat!

Ah! sir, if you cared but to listen,
I could tell you many a tale,
Of the tricks that lad's put me up to,
When out after partridge and quail.

I could tell you of times without number,
That he has outwitted the birds.
It was more than instinct or training,
'Twas reason, sir, just mark my words.

But look, sir! yonder comes mother,
With Le Roy trotting close at her heels;
You can tell by the wag of his tail,
How wondrously proud he feels.

No, Mother, nothing was wanted.
But to let this gentleman see,
That you could understand Le Roy,
And that he could understand me.

I do not know of a more acceptable
Christmas gift, one that will be remem-
bered the year round, than a subscription
to RECREATION.

Frank M. Marble, Southbridge, Mass.

I feel under obligation to you for send-
ing me the Hawkeye, Jr., camera. It is a
fine premium for only 15 subscriptions.
D. B. Wentworth, Somerville, Mass.

IN ANSWERING ADS PLEASE
MENTION RECREATION.



Beer is one of the gifts
of old Mother Earth.

Its elements are products of the soil.
Whether it is good beer to drink
or not depends on the barley-malt,
the hops, the plant and the brewing.

The best barley in the world
will not make good beer unless the
malt is right. Neither can you
make good beer out of the choicest
hops unless the art of the brew-
master can blend them scientifically
with the malt. Sixty years of
practical experience have enabled
Pabst to perfect scientific malting,
and to blend with the malt the fruit
of the hop-vine. The premier pro-
duct of the art is

Pabst
Blue Ribbon

Brewed in a plant that is "as clean
as a Dutch Kitchen," under condi-
tions more sanitary and more thor-
ough than you will find in any food
factory in the world. Perfect brew-
ing and purest materials make it the

Beer of Quality.

ARNICA
Tooth Soap
the International Dentifrice

Beautifies the teeth, hardens the gums, sweetens the breath. Preserves as well as beautifies the teeth. Comes in neat, handy metal boxes. No powder to scatter, no liquid to spill or to stain garments.

25 Cents
At all Druggists.
C. H. STRONG & CO., Proprietors,
Chicago, U. S. A.



MEXICAN OPAL AND SOMBRERO
FREE WITH EACH SUBSCRIPTION TO RECREATION.

To anyone subscribing to RECREATION through me, I will send free a beautiful genuine Mexican Opal as large as a pea, together with a miniature Mexican Sombrero, made of silver and horsehair beautifully dyed. Arthur Thomson, Box 332, San Antonio, Texas.

PLAYS Dialogues, Charades, Recitations and other entertainment books. Send for free catalog of over 2000 plays. Dramatic Publishing Company

358 Dearborn St., Chicago, or 40 W. 28th St., New York

Are You an Amateur Photographer?



If so, would you like a Camera that will photograph

- A whole range of mountains
- A whole sweep of river
- A whole army
- A whole fleet of ships
- A whole city

Or any other vast stretch of scenery or moving objects? THE SWING LENS DOES IT.

The AL VISTA

Is the thing

One of the greatest inventions of the age.

I will give you a No. 5-B as a premium for 12 subscriptions. For particulars address

Recreation, 23 West 24th St. New York City

Sent on Approval
TO RESPONSIBLE PEOPLE

Laughlin Fountain Pen

Guaranteed Finest
Grade 14k.
SOLID GOLD PEN.

To test the merits of

RECREATION

as an advertising medium we make this grand special offer, your choice of

These
Two
Popular
Styles
For Only **\$1.00**
Postpaid to any
Address

(By Registered mail 8 cents extra)

Holder is made of finest quality hard rubber, in four simple parts, fitted with very highest grade, large size 14k, gold pen, any flexibility desired—in feeding device perfect.

Either Style—**RICHLY GOLD MOUNTED** for presentation purposes, \$1.00 extra.

Grand Special Offer

You may try the pen a week; if you do not find it as represented, fully as fine a value as you can secure for three times the price in any other makes, if not satisfactory in every respect, return it and we will promptly refund your money.

Illustration on left is full size of Ladies' style; on right, Gentlemen's style.

Lay this RECREATION Down and Write NOW.

Safety Pocket Pen Holder sent free of charge with each Pen.

ADDRESS :

Laughlin Mfg. Co.
424 Griswold St., DETROIT, MICH.



A SIOUX LEGEND.

SHANNON BRUCE.

Before the Sioux or Mandan,
Before each roving band
Of Ute, or Cree or Blackfoot
Trode o'er Dakota land;

Before the red Apache
Before the Kiowa,
Before the Kaw or the Omaha,
Or the Sauk or the Iowa;

Before the birth of a mortal,
Of a red man or a white,
Before the flight of the seasons,
Before the evil of the night;

There came on the East and the West
winds,
With arrows, with bows and with shields,
Where the hills of the wild Uncomphagre
Run down to Navajo fields,

Two armies with plumes and with banners,
With shields and with arrows and bows,
From bold Idaho, from the land of the
Crow,
To the plain where the Arkansas flows.

They met in the red shock of battle,
They fought without shouting or sound,
In ghostly array for a moon and a day
And the slain were as leaves on the
ground.

The legions that came on the East wind
Were white as the morning is white,
And the West-men were red as the even-
ing is red
E'er appear the last torches of night.

The white men prevailed o'er the red men,
And earth was heaped over the slain
Till mountains untold rose from warm sea
to cold,
And these mark the last place of slain.

And the arrows shot forth in the battle
Flew blazing to uttermost height,
And each arrow that slew, brighter burned
as it flew,
Till it turned to a star in its flight.

And the stars tell the number of fallen,
That fell for a moon and a day,
When the spirits that led pallid ranks
against red,
The red scepter first wrested away.

BIG MONEY In Mail-Order Business

People are buying more by mail than ever before: one mail order house does a business of a million dollars monthly; another receives 2,000 letters daily, nearly all containing money; mail order trading is unquestionably the business method of the future. The field is large, the possibilities unlimited. Let us send you our plan for starting beginners; it covers every point. Enclose stamp.

CENTRAL SUPPLY CO., Kansas City, Mo.

Any of these beautiful, genuine Diamonds and fine Pearls, in solid gold, hand-made mountings will be sent direct from our factory on receipt of price, or C.O.D., subject to inspection. Order by number. We send goods prepaid and guarantee delivery. Your money back if you are not pleased. Our diamonds are of superior quality and we sell only fine, high-grade goods and list everything at wholesale prices. Illustrated Catalogue shows thousands of photographs of the newest and finest goods. IT'S FREE—send for it to-day and save one-half on your Holiday shopping. We are the largest concern in the business and one of the oldest—Est. 1840. We refer to the Commercial National Bank of Chicago. S. T. ALTMUS & CO., Diamond Merchants, Gold and Silversmiths, Diamonds, Watches, Jewelry, Sterling Silver, Cut Glass Novelties, Etc., Etc. 148 A, Stewart Building, Chicago, Ill., U. S. A.

Club Cocktails

Famous the world over for purity. They never vary. The secret of their perfect blend is that they are kept six months before being drawn off and bottled. Be sure you have them in your camp, on the yacht, and on your outing trips wherever you go. They are ready and require no mixing. Simply pour over cracked ice.

For Sale by all Fancy Grocers and Dealers

G. F. HEUBLEIN & BRO.
29 BROADWAY, N. Y. HARTFORD, CONN.

For Hunters, Anglers, Prospectors, Ranchmen, The Press Button Knife

IS THE THING.

A single pressure of the button opens it. It locks open, cannot close on the fingers, saves the finger nails, has 2 blades hand-forged from Wardlow's best English steel, and is in every respect as good a knife as can be made. Ladies' and Gentlemen's sizes in Stag Shell or Ivory handles, including moisture-proof Chamois case securely mailed to any address for **75 CENTS**,

Send for catalogue K for description and prices of other styles.

**THE
NOVELTY
KNIFE CO.**

426 East 52d Street,
NEW YORK.

And all others who go
into the Woods or Hills

Our 5-inch Press Button Hunting Knife can not be excelled. Can be opened with one hand, and will not open or close accidentally.

Handsome Stag Handle

Price, One Dollar

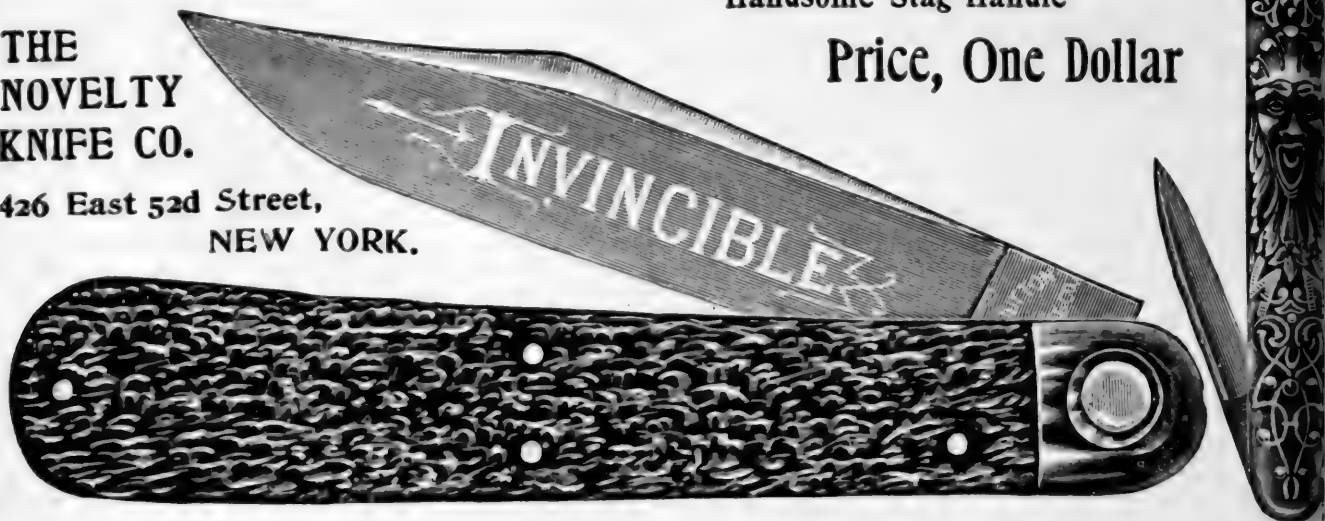

PAROID ROOFING

"IT LASTS"

The most satisfactory roofing for camps. Each roll a complete roofing kit. Adapted to any roof in all climates. No paint required when first laid. Write us for samples and prices.

Mention RECREATION

F. W. BIRD & SON

MAKERS

East Walpole, Mass., U.S.A.

New York Chicago

Washington, D. C.

KEEP YOUR HANDS WARM

Send me 2 yearly subscriptions to **Recreation** and I will send you a pair of **Leather Hunting Gloves** made to your measure, by the Luther Glove Co., Berlin, Wis.

Sample copies for use in canvassing furnished on request

MORE PRAISE FOR ROBIN HOOD!

The manufacturers of Robin Hood powder claim it is not a nitro compound, but a mechanical composition similar to black powder and that it has all the good features of both nitro and black, while practically free from their disadvantages. I have been familiar with nearly all the nitros and have tested them both in the field and at the trap. When my attention was called to Robin Hood I gave it a thorough test, and am well pleased with the result. The recoil is much less than with most of the standard nitros. From the way this powder breaks targets there is surely no lack of speed. The pattern at 40 yards was splendid and there seemed no falling off when the load was increased from 3 to $3\frac{1}{4}$ drams. No special wadding; one card and one ordinary black edge gave about the same results as 3 or more wads. This powder makes a little more smoke than E. C. or DuPont, though not enough to interfere with the second barrel. Those who complain of the sharp recoil of other smokeless powders in light guns will find this compound practically free from it with ordinary loads. The makers claim it is safe in any gun that will stand black powder and can be loaded the same as black.

W. F. Jones, Marion, Ind.

A Sportsman's Encyclopedia

THE 20th CENTURY BOOK

Nearly 500 pages—1000 Illustrations.

THE COMPLETE

We have received a personal letter of commendation from Theodore Roosevelt, Jr., White House, Washington, D. C. about this book.

Sportsman's,
Hunter's,
Fisherman's,
Angler's, Trapper's
and Camper's Manual

A veritable Mine or Epitome of Information.

Startling Facts never before published
All handsomely bound, prepaid for

One Dollar Bill if ordered now

Your money back if you are not more than pleased.

Address

Author and Publisher **"BUZZACOTT"**
Racine Jct., Wis., and Chicago, Ill.
DEPT. A.

"Better than most books sold at treble the price" so says E. A. Graves, Mining Engineer, Streator, Ill., and many others.

THE LATEST, SAFEST AND BEST CANVAS BOAT

Is what we offer you. A Boat built on modern lines that will prove a pleasure to own and use. Selected materials used throughout, and it comes to you **guaranteed** the best. A handy and safe boat for fishing and shooting. Send 4 cents in stamps for catalogue and reliable testimony.

Mention RECREATION.

LIFE SAVING FOLDING CANVAS BOAT CO.

Kalamazoo, Mich.



Latest patent and improved Canvas Folding Boat on the market. Puncture proof; Tempered steel frame. No bolts to remove. Folds most compact of any boat made.

TO AMATEUR PHOTOGRAPHERS

Here is a Chance
to Get a
FINE CAMERA EASILY

A 4x5 Weno Hawk-eye film camera listing at \$8, for 5 yearly subscriptions to RECREATION. A No. 3 folding Weno Hawk-eye film camera, listed at \$15, for 10 yearly subscriptions to RECREATION.

These are both neat, compact, well-made and handsomely finished cameras, capable of doing high-class work.

*Sample copies for use in canvassing
furnished on request.*

Address **RECREATION**

23 West 24th St.

NEW YORK.

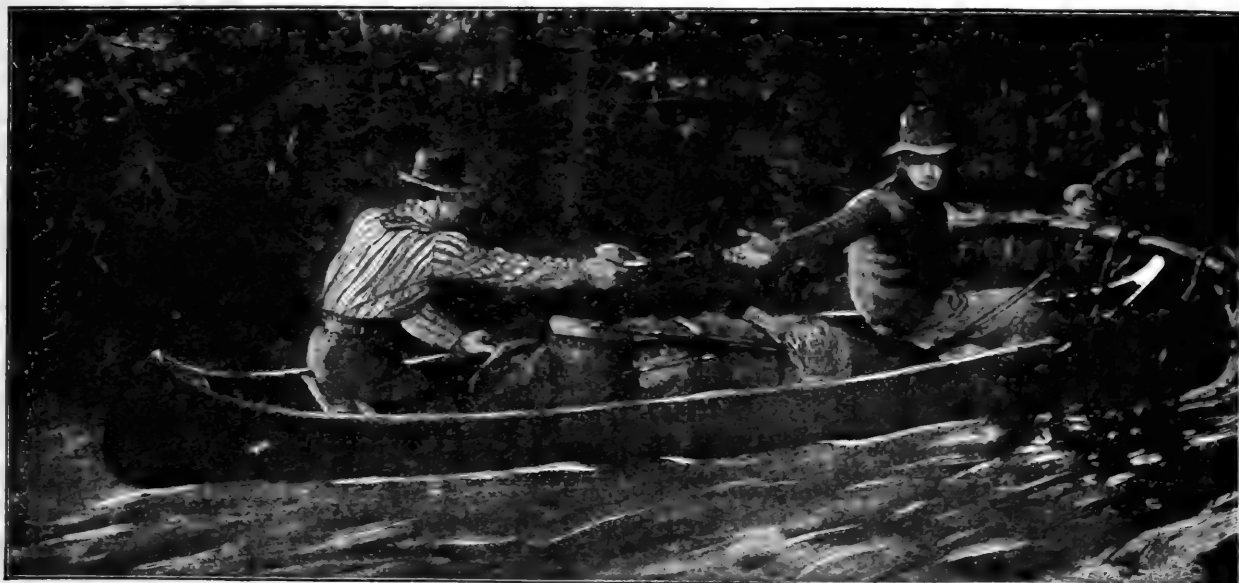

DRAWN BY ROY MASON.

A Marble Safety Pocket Axe

is the handiest tool a sportsman ever carried, and a life-saver and comfort-provider in the woods. Hunters, canoeists, yachtsmen, campers, fishermen, all need it and unite in praising its supreme utility. Has a guard which closes over the blade and allows it to slip into hip or breast pocket or hang safely at the belt. Made from the finest steel and superbly finished. No. 1, 16-oz., \$2.50. No. 2, 20-oz., \$2.50. Cheaper grade with wooden handle \$1.50. From sporting goods dealers or direct from us.

A fine catalogue of sporting necessities free for the asking. Ask for catalogue A

MARBLE SAFETY AXE CO.,

GLADSTONE, MICHIGAN, U. S. A.

A SPORTSMAN'S BOAT

Mullins' "Get There" Steel Duck Boat

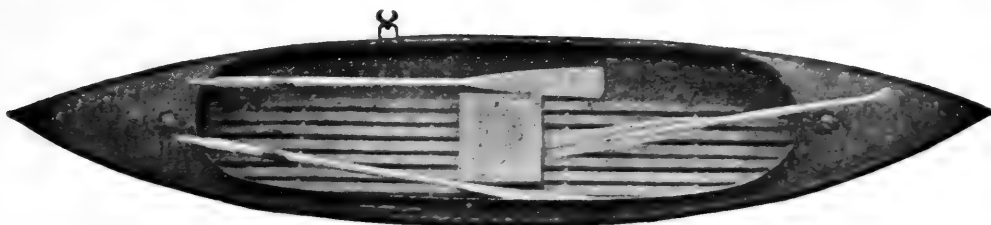

14 ft. long, 36-inch beam. **PRICE, \$20** Crated on cars Salem.

Endorsed by Thousands of Sportsmen. Air Chamber each end. Always ready. No repairs
Send for handsome free book. Mention RECREATION.

W. H. MULLINS, 228 Depot Street, Salem, Ohio

For Sale or Exchange:—Stevens Ideal, No. 45 Rifle, 34 inch barrel, 25-25 caliber, special 12 inch twist, Lyman sights, Gun bore treatment, Ideal lubricating machine and complete set of tools, ammunition, etc. Cost over \$60 Want Parker, Smith or Ithaca hammerless 12 gauge gun of equal value, or will take \$30 cash. Itemized list and particulars on request with stamp. C. O. Moseley, Limona, Florida.



The "Perfect" Fishing & Hunting Motor Boat.

Length, 17 ft. Beam, 4 ft Weight 350 lbs. Speed 6 to 7 miles. **Price \$125**

The above equipped with The "Valveless" Gasoline Marine Motor, the most simple Motor on the market. Small weight. Large power. Perfect control. **Price Motor Complete \$75.**

F. W. SHERMAN, 16-18 Exchange Street, Buffalo, N. Y.

Write for catalogue. **Agents Wanted.**

D.M. TUTTLE CO. 10 PINE STREET CANASTOTA, N.Y.

CATALOGUE FREE.

BREAK SPARK. GASOLINE ENGINES & LAUNCHES. JUMP SPARK.

ANOTHER GREAT OFFER TO AMATEUR PHOTOGRAPHERS

A 4 X 5 SERIES 1 KORONA CAMERA
LISTED AT \$12.50, FOR 8 YEARLY SUBSCRIPTIONS TO *RECREATION*;

A 5 X 7 SERIES 1 KORONA CAMERA
LISTED AT \$18, FOR 12 YEARLY SUBSCRIPTIONS;

A 4 X 5 SERIES 2 KORONA CAMERA
LISTED AT \$18.50, FOR 14 YEARLY SUBSCRIPTIONS;

A 4 X 5 SERIES 3 KORONA CAMERA
LISTED AT \$21, FOR 18 YEARLY SUBSCRIPTIONS;

A 4 X 5 SERIES 4 KORONA CAMERA
LISTED AT \$25, FOR 20 YEARLY SUBSCRIPTIONS;

A 4 X 5 SERIES 5 KORONA CAMERA
LISTED AT \$36, FOR 30 YEARLY SUBSCRIPTIONS.

*SAMPLE COPIES, FOR USE IN CANVASSING,
FURNISHED FREE*

ADDRESS

RECREATION

23 WEST 24TH STREET, NEW YORK CITY

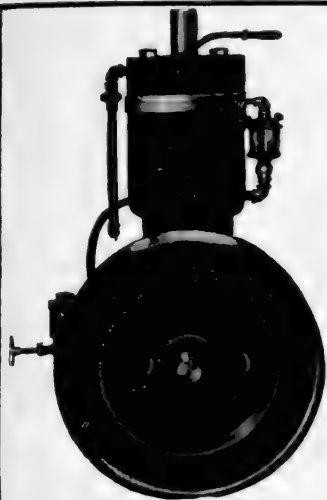

SMALLEY

MARINE GASOLINE MOTORS

are designed for use in any kind of a boat requiring from 1½ H. P. to 20 H. P. Either single or double cylinder. Simple, mechanical, handsome, durable, positive, economical, and moderate priced. Our speed control, propeller equipment, and many other features should be investigated.

OUR NEW PLANT

is the largest in the world devoted exclusively to the manufacture of marine gasoline engines. We operate our own pattern, foundry, forge, and machine departments. We manufacture every part of our engines from fly wheel to propeller.

Every engine is connected to its propeller and given an actual water test before placed in purchaser's hands

Send for illustrated catalogue. Address Dept. C

SMALLEY MOTOR CO., Ltd., Bay City, Mich., U.S.A.

I am a little girl, 10 years old, and fond of going shooting with papa. He got me a Harrington & Richardson shot gun as a premium from RECREATION. Papa says it is the nicest single gun he ever saw and has as high grade work on it as his costly double gun.

Ruth Wakeman, Sun Prairie, Wis.

"So he advertised for a wife?"

"Yes, and he got 23 letters from other men saying he could have theirs."—New York Times.

Something Special — Playing Cards

Free:—To each person sending me \$1 for one year's subscription to RECREATION, or sending it direct to be placed to my credit, I will forward, all charges prepaid, a pack of elegant gold edge playing cards. These are no cheap second quality cards but first quality of extra selected stock, highly enameled and polished, fancy set pattern backs, each pack wrapped in handsome glazed wrapper and packed in strong telescope case.

L. J. Tooley,

141 Burr Oak St., Kalamazoo, Mich.

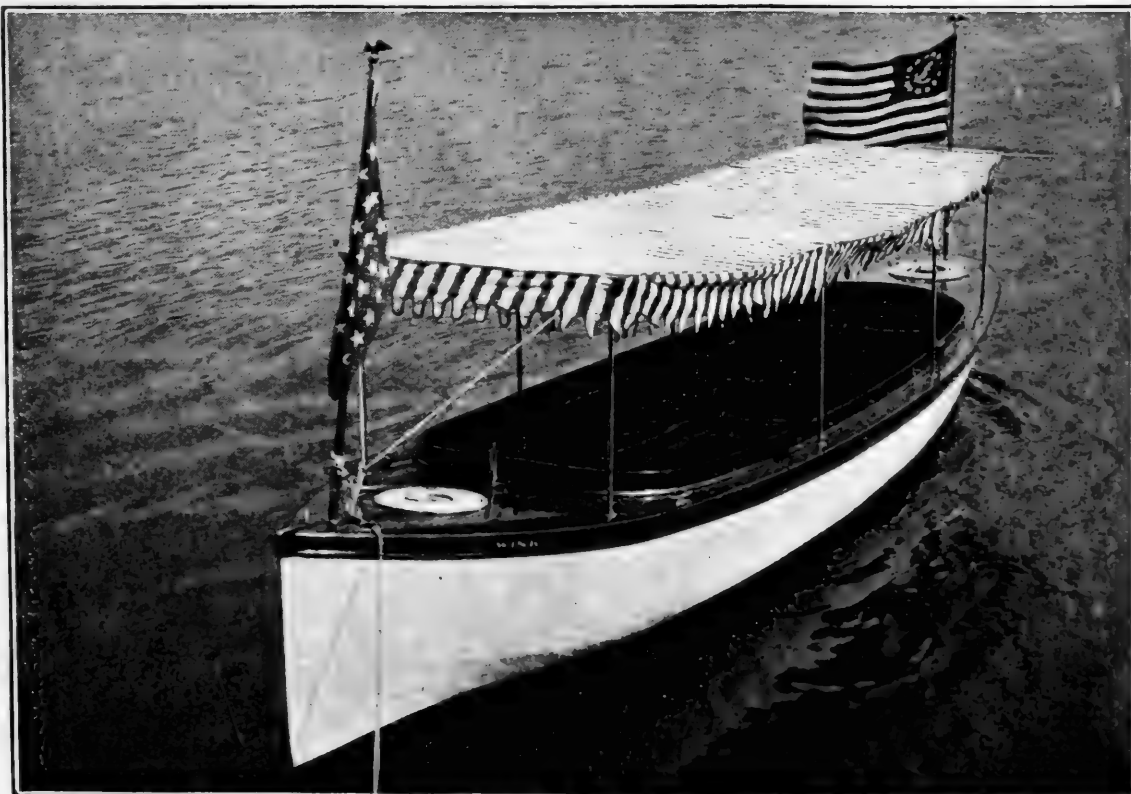

GASOLINE ENGINES and LAUNCHES UP TO DATE

Self-Starting

Jump or Break Spark

Catalog Free

D. M. Tuttle Co. 10 Pine Street Canastota, N. Y.



The "Bristol" Calendar

THIS illustration gives but a faint idea of our beautiful calendar, which is printed in ten colors, making it a handsome and striking design. Hang one in your office, den or home, and when you want a fishing rod be sure to get a "BRISTOL." Sold by all dealers. Calendar sent to any address on receipt of ten cents (stamps or silver) to cover cost of mailing provided you mention this magazine.

Ask for Catalog "D," describing 25 styles of "Bristol" Steel Fishing Rods — it is free.

The Horton Mfg. Co.
Bristol, Conn., U. S. A.



11-foot Special

Folding Canvas Boats were not satisfactory until the **King** was produced. **It's a revelation** in boat construction. Nothing like it ever made. **Nonsinkable. Can't turn over. Puncture-proof.** Wear longer than a wooden boat. **NO repairs.** No cost for storage. **Always ready.** Folds into a small, neat package, — **carry by hand.** Used by the U. S. Navy. They are simply wonderful. A thoroughly patented article. Beware of imitation. Made only by ourselves.

A catalogue of 70 engravings and 350 testimonials sent on receipt of 6 cents. Mention RECREATION.

King Folding Canvas Boat Co.
Kalamazoo, Mich. U. S. A.

Do you want a Good, Reliable,
Substantial, Well Made

Single Barrel Shot Gun

If so, send me

10 YEARLY SUBSCRIPTIONS

and I will send you such a
Gun as a premium

It is made by the *DAVENPORT ARMS CO.*, and this means it is made of good material and that only good workmanship is put on it.

This is one of the many remarkable opportunities *RECREATION* is offering to men and boys to fit themselves out completely for shooting and fishing.

Sample Copies for Use in Canvassing
Furnished on Application.

Address

RECREATION

23 W. 24th St.,

New York City

When You Get Up In the Night

The Ever Ready Pocket Flash Light



will enable you to find the match box without breaking your neck.

A luxury to every one who camps out, or who lives in the country.

No Wires No Chemicals No Oil, Smoke nor Odor No Danger

Price complete, \$3. Extra battery (No. 10), 30 cents.

The Ever Ready House Lamp

Is a luxury for man, woman or child. It obviates all hunting for matches in the dark. It saves you from falling over the furniture when searching for the water pitcher the other door, or whatever you may seek.

Price complete, \$3.

Extra battery (No. 610) 30 cents. Extra bulb, 50c.

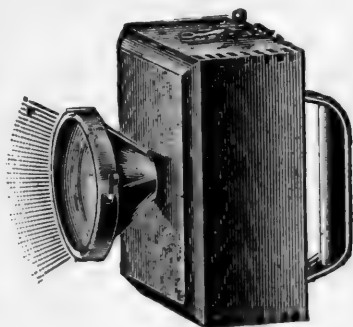

Fine Lens, Highly Polished Reflector, Finely Finished Nickel Trimmings.

The Ever Ready Ruby Electric Lamp



will save the eyes, the patience and the conscience of the amateur photographer who may be fortunate enough to own one.

It is provided with patent catch, so that ruby glass slide can be raised and a strong white light can be had.

One dry battery will last 3 months and costs only 30 cents.

Price of lamp complete, with one battery \$2.50.

Remit by P. O. or
Express Money Order.

B. L. SCOTT

23 West 24th Street,

NEW YORK.

I refer, by permission, to the Editor of RECREATION.



J. BLAKE
Buyer and Exporter of
RAW FURS
1 WEST THIRD ST.
NEW YORK

Write for price list

Taxidermists' Glass Eyes for Stuffed Birds and Animals
Oologists' and Entomologists' Supplies
Materials

Send 5c. in stamps for catalogue

FRED. KAEMPFER, 88 STATE ST., Chicago, Ill.

Taxidermy work done in all its branches

Mention RECREATION

Free: If you send your subscription to RECREATION through me or direct to the office to be placed to my credit, I will send you, free of charge, any one of the articles mentioned below:

Shot gun bench crimper, sells for 75 cents, in 10-12 16-20 gauge.

Shot gun cleaning rod, three attachments, sells for 50 cents, in 10-12 16 gauge.

Micrometer powder and shot measure, adjustable, and for both black and smokeless powder, sells for 65 cents.

U. S. Government rifle cleaner, any caliber, with attachments, sells for 60 cents, packed in neat canvas bag.

A duck, snipe or turkey call, sells for 75 cents each, best made.

A hand painted sporting picture, suitable for framing, and just the thing for your den, worth \$1.50.

"Hunting in the Great West," by G. O. Shields. H. S. Hill, 815 11th Street, N. E., Washington, D. C.

For Exchange:—Trout or bass flies for wood duck, mallard and golden pheasant feathers. C. J. Engle, Box 153, Oakesdale, Wash.

BUFFALO SKULLS

AND

Buffalo Horn Novelties

Send for Illustrated Catalogue. Mention RECREATION.

E. W. STILES

141 Washington St.

Hartford, Conn.

MOUNTAINS OF FLORIDA.

If you are thinking of going to Florida this Winter—want to shoot a wild turkey or alligator or want to know anything about Florida, better write to C. H. STOKES, The Jolly Palms, Mohawk, Florida.

FINE MOUNTED GAME HEADS, BIRDS, ETC., for sale at unheard-of prices. Send 10 cents for photos.
JOHN CLAYTON, Taxidermist, Lincoln, Maine

AN IMPORTANT OFFER

For 2 Yearly Subscriptions to RECREATION

I will send you

A RIFLE WICK PLUG

Made by HEMM & WOODWARD, Sidney, Ohio, 30 caliber up to 50 caliber.

OR

A SHOT GUN WICK PLUG

20 gauge up to 10 gauge

For 3 Yearly Subscriptions to RECREATION

A Pair of Shot Gun Wick Plugs

20 to 10 gauge.

Sample copies for use in canvassing furnished on application.

Address **RECREATION, 23W. 24th St., N. Y. City**

I received the King folding canvas boat, and the folding cot bed you sent me as premiums. I find them all right and thank you sincerely.

J. H. Richards, Portland, Me.

Date, _____ 190

G. O. SHIELDS,

Editor and Manager of RECREATION, 23 West 24th St. New York.

Herewith find \$1.00 for which please send me RECREATION one year

beginning with _____ number,

Name, _____

Remit by P. O. or Express Money Order, or New York Draft.

DETACH THIS, FILL OUT, AND SEND IN

WRITE YOUR CONGRESSMAN.

Henry A. Castle, auditor for the Post Office Department, shows an annual shortage of half a million dollars or more in the money order system. The opposition to the Post Check Currency plan comes largely from this bureau because the new currency would practically abolish the money order system.

This opposition should not be permitted to block the establishing of a currency that combines a safe and convenient draft for remittance, with a reliable circulating medium. The Post Check Currency seeks to benefit the masses. It is a government issue of the same relative value as the green-back and is so controlled that it can be used safely in the mails for the payment of small accounts. It has a host of friends and no enemies, outside of a limited class who oppose it because of self interest.

The bill should become a law at the present session of Congress and it will, if public sentiment becomes sufficiently aroused to express to congressmen its views on the subject. Letters to congressmen from their constituents will aid the cause.

Gazette, Janesville, Wis.

Citizens should request their representatives in Congress to see that more convenient money is furnished the people.—
EDITOR.

"At the foot of Pikes Peak."

COLORADO SPRINGS.

Like a child at play, Colorado Springs sits basking in the sunshine at the foot of Pikes Peak, amid the most enjoyable surroundings. No location could be more delightful. This region is best reached from the East by the

NEW YORK CENTRAL LINES

and their connections, with but one change of cars from New York or Boston.

For particulars inquire of any New York Central Ticket Agent.

A copy of "America's Winter Resorts", will be sent free on receipt of a two cent stamp by George H. Daniels, General Passenger Agent, New York Central & Hudson River Railroad, Grand Central Station, New York.

Fay & Bowen Motors and Launches

Operated by Gasoline Vapor

The Fay & Bowen Marine Motor is a revelation to those who have used others. Reliable, safe, durable and easy to operate. Remarkable speed control. Best of all, it starts when you start it. No handle or crank is used.

Our patent igniter is absolutely unique and always instant and positive in action. It is really the only perfect and satisfactory igniter. Motors complete from 1½ to 25 actual Horse Power ready for installation.

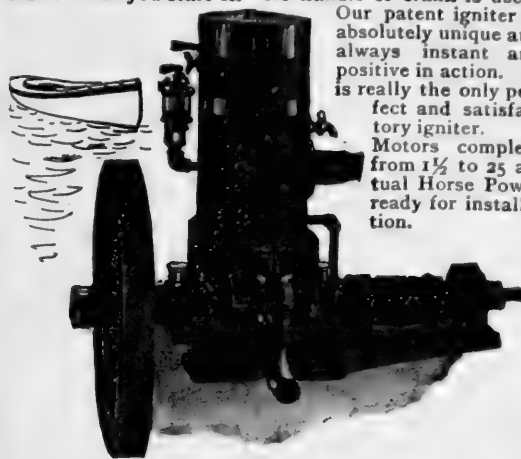

We also build a line of the finest launches afloat, complete and with our motor installed and all ready to run. We make these in either the usual round stern model or our flat stern torpedo model in lengths from 18 to 35 feet. We can furnish large cabin launches on special order. For excellence of workmanship and beauty of finish and design our boats are unsurpassed. Ask for description of our fast torpedo outfits.

Send for Catalogue and live testimonials from satisfied customers. Our customers are our best advertisers.

Fay & Bowen, 28 Mill St., Auburn, N. Y.

Perfect Comfort in Traveling

VIA

OLD DOMINION LINE

TO

Gunning Grounds

OF

Dismal Swamp, Chesapeake Bay, and James River, Virginia; West Virginia; Currituck, Albemarle and Pamlico Sounds, and Roanoke Island, North Carolina.

Sailing every week-day from Pier 26, North River, foot of Beach Street, New York, at 3 p. m.

Dogs, on chain, carried free, when accompanied by their owners.

Connections made at Norfolk and Richmond for all points South and Southwest. Through tickets and baggage checks.

H. B. WALKER, Vice-Pres. and T. M.
J. J. BROWN, General Passenger Agent.

General Offices: 81-85 BEACH STREET, New York.

Paris Exposition, 1900: Gold Medal and Highest Award

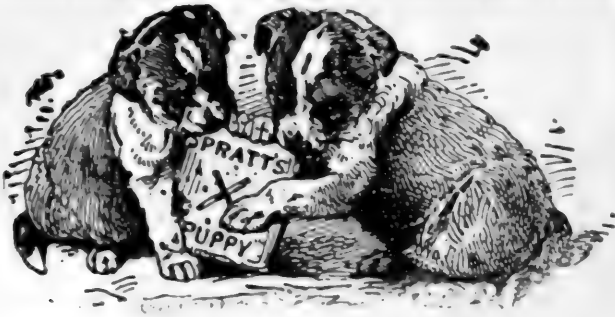

SPRATT'S PATENT PUPPY CAKES

Are the BEST and CHEAPEST.

SPRATT'S PATENT PUPPY CAKES

For puppies of all breeds and for small dogs that get very little exercise, we manufacture specially refined and tasty cakes.

SPRATT'S PATENT PUPPY CAKES

Are used by the leading kennel owners and breeders throughout the world.

SPRATT'S PATENT PUPPY CAKES

Are sold by leading grocers, sporting goods dealers, druggists, etc.

Price in Cartons, 10c. 25 @ 50c.

In Bags, \$1.90 \$3.50 and \$7.00.

We also manufacture a specially prepared food for Dogs, Puppies, Cats, Rabbits, Poultry, Game, Pigeons, Fish, Birds, etc.

Write for our Catalogue "Dog Culture," with practical chapters on the feeding, kenneling and management of dogs, with a chapter on Cats, FREE.

SPRATT'S PATENT 450 Market St. Newark, N. J.
714 S. 4th St., St. Louis, Mo.

(Am.) Ltd. 1324 Valencia St. S. Francisco, Cal.

Manufacturers of all kinds of Dog Foods, Medicine & Soap



B. Bernard

Buyer of Raw Furs and Ginseng Root.

150 Bleeker St., New York.

Quotations sent on request.

Squab Book Free



Squabs are raised in 1 month, bring big prices. Eager market. Astonishing profits. Easy for women and invalids. Use your spare time profitably. Small space and capital. Here is something worth looking into. Facts given in our FREE BOOK, "How to make money with Squabs." PLYMOUTH ROCK SQUAB CO., 11 Friend St., Boston, Mass.

SPORTSMEN

Learn to Mount Birds, Animals, Heads, Antlers, Tan Furs, Etc.



We teach the art of TAXIDERMISTRY perfectly by mail. The game season is open and you will secure some fine trophies. They deserve a place in your home or office. Why not

BE YOUR OWN TAXIDERMIST?

We teach the art easily and quickly to any one by Standard Methods. Expert instructors; reasonable prices. Endorsed by all leading sporting journals, and recommended by the most eminent taxidermists. Our interesting catalog tells all about it, and it's yours for the asking.

Write for one to-day.

The Northwestern School of Taxidermy, Inc.
411A BEE BUILDING OMAHA, NEB.

A NICKEL-STEEL 38-35.

I have what I consider the best all around rifle. It is a 38-55 with nickel steel barrel. It shoots black, low pressure and high pressure powders with equally good results, and is thus adapted to any game from squirrels to bear. My gun is fitted with the new Savage micrometer sights as well as with Lyman sights. The 38-55 is a famous target rifle, and with the new barrel and high pressure powder, should prove an unequaled game killer. To test its penetration, I placed a number of fence rails, 1 to 1½ inches in thickness, side by side. High pressure powder drove a metal cased bullet through 40½ inches; low pressure, through 21½. I should like to know if any other reader of RECREATION has a gun like the one described.

F. N. Hack, Baltimore, Md.

I prefer RECREATION to any sportsman's periodical I have seen and I have seen many. Success to your every undertaking. I will do all I can to help protect our game and birds.

T. Wilson Stiles, Merchantville, N. J.

I heartily endorse RECREATION and will do all in my power to further its cause.

J. H. Rule, Basin, Mont.

"Pigeons and All About Them"

F. M. GILBERT'S latest work. 264 pages, illustrated—strictly up-to-date. The only complete Pigeon Book published in the last twenty years. Cuts of all the best-known varieties. Standards of all varieties. Tells how to build loft, buy, mate, breed, feed, how to ship to customers, how to prepare for shows and ship to shows, how to prevent and cure disease, tells which are the best breeders and feeders, tells best varieties to breed in a city and which in small towns, tells how to mate for color—in fact, it tells just what it has taken the author forty-five years to learn by actual experience. Endorsed by all the leading fanciers in America. Hundreds of letters praise it. Fourth edition now out. To get it promptly send one dollar to Frank M. Gilbert, Evansville, Ind.



INCREASE YOUR INCOME

by learning profitable poultry raising. We successfully teach it in all its branches. Seven distinct courses by correspondence, also a residence course at our 60-acre poultry farm. Our faculty are practical poultrymen, who can and will make you a successful poultry raiser. This fascinating and profitable business is still in its infancy and there are tremendous opportunities for those who begin NOW. Write to-day for illustrated booklet, fully describing our various courses of instruction. COLUMBIA SCHOOL OF POULTRY CULTURE, Box 610, Waterville, N. Y.

JAMES P. BABBITT,

Importer and Dealer in

Taxidermists' Supplies, Bird Skins, Eggs and Publications. Ink Well and Thermometer Fittings for Moose, Elk, Caribou and Deer Feet. Send 5c. for Illustrated catalog.

BABBITT'S TANNING FLUID

Will tan anything from a squirrel to a deerskin with the hair on. A boy can use it with success. \$1.00 a bottle, by mail postpaid.

10-12 Hodges Ave., Taunton, Mass.

Mention RECREATION.



FAITHFUL DOGS

AND TWO

FAITHFUL REMEDIES

You can't expect lively activity and strength out of a wormy dog, any more than strength in a wormy piece of wood.

Nausea, colic, pains, restlessness, fever, fits—these are all symptoms of worms, all of which disappear with the administration of

Sergeant's Sure Shot

50c. per Bottle

Or take a dog suffering with any ailment common to dogdom—Stomach out of order, Cold or Distemper, Fever, Mange and General Debility or Nervousness—he needs something that will correct the trouble at once, and then built up all the enervated organs.

The safe, sure thing that will do this are

Sergeant's Condition Pills

50c. and \$1.00 per Box

Ask your Druggist for these Dog Remedies, or your Sporting Goods man; if he hasn't them, send us the price, and we'll deliver them post-paid.

Get our handsome Dog Book and a set of Pedigree Blanks free. Send address and 3 cents to cover postage.

POLK MILLER DRUG CO., Richmond, Va.

**O
R
D
E
R**

TAKE TIME BY THE FORELOCK

Order your hunting boots now. Don't

wait till you want them.

Every one else will want them then,

and we can't make

them all at once.

The Old Well-Known Favorite

Thompson-Quimby

Hunting Boots and Moccasins



N



O

W

Measurement blanks and prices on request. Mention RECREATION.

T. H. GUTHRIE

33 William St.

NEWARK, N. J.

How is your Muscle?

Would you like to build it up?

How are your Lungs?

Would you like to expand them?

How is your Circulation?

Would you like to improve that?

If so, send me **6 yearly subscriptions** to RECREATION, accompanied by a money order for \$6, and I will send you a new

PROFESSIONAL PUNCHING BAG

made by H. D. CRIPPEN, No. 52 Broadway, New York and listed at \$6.95.

There is a frame with the bag that you can attach to a door casing, a window casing or a wall, or a board fence, or anywhere else you may see fit to put it, and you will thus have a small gymnasium of your own. The Crippen bag is one of the liveliest ever devised, and if you will put 20 minutes a day on it, for a month, you will find a wonderful improvement in your muscle and your health.

Sample copies of RECREATION, for use in canvassing, will be mailed free.

We have a good many rabbits, a few squirrels, and fewer quails and grouse. Hunters hereabout use ferrets and kill every rabbit they start. I used a 30-30 last winter and got about 25.

R. O. Chester, Climax, Mich.

"Miss Spinster doesn't grow old very fast; she's been 30 for the past 3 years."

"Sort of a 30-30 repeater, eh?"

For Sale:—Good Al Vista Camera. Also 6½ x 8½ View Camera. Exceedingly cheap. Frank Wilson, Box J, Elk Rapids, Mich.



It's in the Back Action

The action that takes the strain off the **shoulders**—the **buttons**—the **trousers**—the **patience**. Found only in

PRESIDENT Suspenders

Satisfactory to you or money back from the manufacturers. No leather to **soil** the shirt. Buckles cannot rust. At your dealer's or by mail, 50c and \$1.00.

THE C. A. EDGARTON MFG. CO.,
Box 219 Shirley, Mass.

Game is scarce in this part of the Catskills. We have a few rabbits, grouse, and red and gray squirrels, also some coons, but that is about all. My father owns land here on which he has over 60 tame German and Tuxedo deer. They multiply rapidly.

Jerry Zweighaft, Haines Falls, N. Y.

Game is plentiful here. I go out when I have time and get 4 or 5 ducks or prairie chickens. There are lots of moose, elk, deer and bear in Duck mountains, North of here, and in Riding mountains, West.

A. W. Brosseau, Grand View, Man.



MATTHEW I. FOX

1123 BROADWAY

Madison Square and 25th Street

TAILOR AND IMPORTER

I refer by permission to the editor of RECREATION

Going Fishing?

Well fixed for rods? If not,
send me 5 yearly subscriptions to

RECREATION

and get a Bristol Steel Rod—
any one listing at \$6.00 or less.

Everybody knows what a Bristol
Steel Rod is. It is equal in
strength, durability, suppleness,
and all the other good qualities to a
split bamboo rod costing \$20.

This is a great opportunity
and holds good only **SIXTY**
days.

Sample Copies of Recreation
for use in canvassing fur-
nished on application.



IDEAL PAPER SHOT SHELL TRIMMER

SOMETHING NEW.

With it you can cut off the soft and frayed ends of shells that have been fired and they will be *as good as new*. Why throw *good shells away*? Send us 6 cents in stamps for *latest IDEAL HAND BOOK*, giving full information of all *New Goods* and much matter of interest to shooters. Address,

PRICE
\$1.50
Special
List.

IDEAL MANUF'G CO., 12 U St., NewHaven, Conn., U.S.A.

THE PHIL. B. BEKEART CO., of San Francisco, Cal., Agents for Pacific Coast.

When you write please mention Recreation.

I have found the Savage .303 accurate, safe and reliable. The smashing power of the .303, when using soft nose or expensive bullets, is wonderful. Game will not get away if struck in any vital spot, as the shock seems to paralyze a deer instantly. I have never had the slightest trouble in any way with either of the 2 Savage rifles I have owned, and would not wish anything better in any way.

F. R. Barber, Warrens, Wis.



"Collan-Oil"

preserves leather and renders shoes and harness positively

WATERPROOF

Used by the U. S. the Army and Navy and National Guard.

Send 25c. for trial can.

AGENTS WANTED

Write for terms and circulars

J. R. BUCKELEW

Dept. A. 111 Chambers St., N. Y.



INDIAN CURIOS

WHOLESALE & RETAIL
CURIO DEALERS'
SUPPLY DEPOT.

Bead Work, Baskets, Elk Teeth, Mexican Goods, Beads, Fossils, Minerals, Arrow-Heads, Pottery, Alaska Ivories, Shells, Agates, Photos, Great Stock, Big Cats. 5c., stamps. Mention RECREATION. If a dealer say so.

L. W. STILWELL,

DEADWOOD

SO. DAKOTA



Practical Common Sense in 6 Sizes.

CAMP STOVE

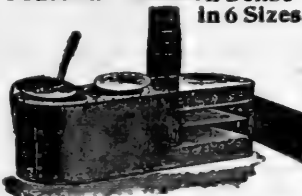

Either with or without oven. The lightest, strongest, most compact, practical stove made. Cast combination sheet steel top, smooth outside, heavy lining in fire

box and around oven, holds its shape, telescopic pipe carried inside the stove. Burns larger wood and keeps fire longer than any other. Used by over 9,000 campers and only one stove returned.

For catalogue giving full particulars, mention RECREATION and address,

D. W. CREE, Manufacturer, Griggsville, Ill.

Newhouse Traps

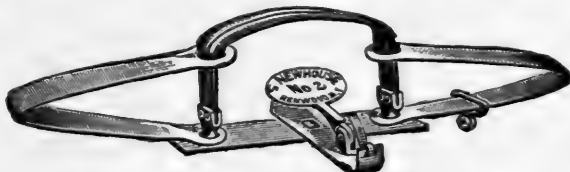

THE STANDARD FOR OVER FIFTY YEARS

Used by all professional hunters and trappers, who find that

The Best Trap is the Cheapest

Complete illustrated catalogue on application.

ONEIDA COMMUNITY, LTD., Kenwood, N. Y.

KOENIG'S SHELL EXTRACTOR.



Every shooter should have one—carry it in a vest pocket. Fits any gauge shell. Koenig's Gun Catalogue, Free.

10 Cts. Postpaid.

E. G. KOENIG, NEW JERSEY'S LARGEST GUN HOUSE
SOUTH BROAD ST., NEWARK, N. J.

ANTI-RUST WICK PLUGS AT REDUCED PRICES

Arms fitted with Wick Plugs can not Pit or Rust

REDUCED PRICES

Shot Gun, per pair, \$1.00 postpaid

Shot Gun, per Plug, .50 postpaid

Rifles, per Plug, .50 postpaid

Give gauge and length of barrel

HEMM & WOODWARD, Sidney, O.

Write for Circulars. Mention RECREATION





It Still Leads Them All for Light Recoil Great Penetration Even Pattern

Robin Hood Powder

COMET and ROBIN HOOD LOADED SHELLS

MANUFACTURED BY
The Robin Hood Powder Co.
Swanton, Vt.



Shooting Jacket
\$ 3.00

GUARANTEED all wool, seamless, elastic, close fitting, but not binding, comfortable and convenient, Designed especially for duck shooters, trap shooters, etc., but suitable for all out-door purposes. Must be seen to be appreciated. Made only in two colors—dead grass and Oxford Gray.

Send us your address for one of our Gun Catalogs

The H. H. KIFFE CO., 523 Broadway, N. Y.

CEDAROLEUM [TRADE MARK] **The Ideal Lubricant and Rust-Preventive**

Keep up with the times and in this New-Year try something "NEW" and "BEST OF ALL." It is colorless and you can use it anywhere on your gun or rifle. Manufactured of the purest chemicals, it meets a demand and need. Far superior to any oil or vaseline. It is specific for cleaning rifles and guns after using nitro-powder as well as black. Will prevent RUST.

Its peculiar substance makes it the finest of LUBRICANTS for the mechanism. Put up in a neat tube with an injector, and is handy to carry in your pocket. **Postpaid sample, 15 cents.**

CEDAROLEUM CO. Mention RECREATION. **PERKINSVILLE, VT.**

BRADLEY'S ANTI-RUST ROPES!

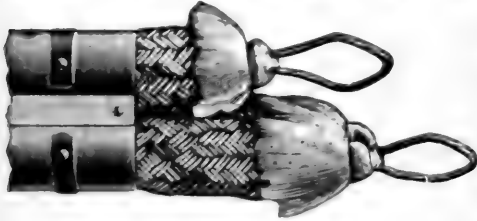

For SHOT GUNS, RIFLES and REVOLVERS. They cannot rust or pit if these ropes are used. No more worrying to keep your fire arms in perfect condition. Sent postpaid, \$1 per set for Shot Guns; 50c. for Rifles; 25c. for Revolvers. Give gauge and length of barrel. Send for circular giving full particulars.

BRADLEY'S SHOT GUN SIGHT
Makes wing shooting easy and certain. Scores greatly increased at trap and in field. Instantly attachable and detachable. Price, post-paid, 50 cents. Send for circular.
Address **C. L. BRADLEY, CLARKSVILLE, TENNESSEE.**
Mention RECREATION.

THE MALCOLM RIFLE TELESCOPE



Modern Hunting and Target Scopes from 8-power up. With our improved mountings the Scope lies close to the barrel. Our "Rough Rider" of 8-power is an ideal hunting glass. Our "Bulls Eye" at 5 to 8-power is perfection itself for both hunting and target purposes.

SEND FOR 1903 CATALOGUE
Mention RECREATION.

THE MALCOLM RIFLE TELESCOPE MFG. CO.
F. T. CORNISH, Mgr.

Established 1857 **SYRACUSE, N. Y., U. S. A.**

1904 Art Catalog



CONTAINS

**Photographs and Descriptions
Sixteen Guns**

ABOVE CUTS SHOW

No. 3, List Price, \$80.00

No. 2, List Price, 60.00

WRITE FOR SPECIAL PRICES
MENTION RECREATION

Ithaca Gun Company
I T H A C A , N E W Y O R K

Winter Is Coming

GET A PAIR OF SKATES

For yourself, your best girl or your brother, or for some other girl's brother, or for any one you love, and who is fond of skating



LADIES' LOCK LEVER

GRADE 3

For 5 Yearly Subscriptions to **RECREATION**

I WILL SEND YOU

A Pair of Lock Lever Skates

OR

A Pair of Ladies' Lock Lever Skates

Grade 3, made by Barney & Berry, Springfield, Mass.

LOCK LEVER

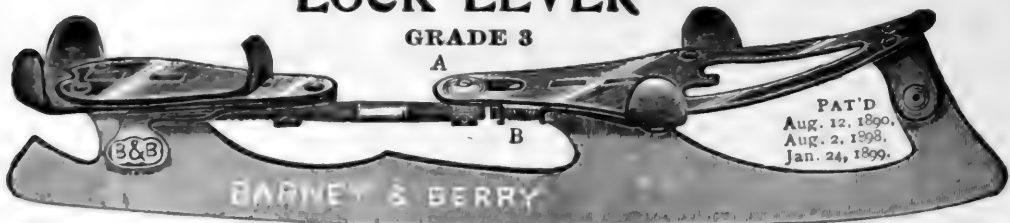

As every skater knows, these are the best skates made in the world.

The winter season is approaching, and you could scarcely select a more appropriate present

**FOR A MAN, OR A WOMAN,
A BOY OR A GIRL**

than a pair of these high-grade skates. Only a limited stock on hand, and when these are gone this offer will be withdrawn.

Sample copies of **RECREATION** for use in canvassing furnished on application.

ONE OF THE 9
“SYRACUSE”
 Built for Business.



COPYRIGHTED 1903

SYRACUSE ARMS CO.

This picture shows the result of a
SINGLE SHOT from a **SYRACUSE**
16 GAUGE

THREES OF THIS KIND ARE HARD TO BEAT

Write for a
 Syracuse
 CAT.

SYRACUSE
ARMS CO.

SYRACUSE, N. Y.

Mention RECREATION.

WOLF SMOKELESS

A New Semi-Bulk Powder



EASY TO LOAD

On Receipt of 75 cents

We will send a sample can, containing 120 loads, sent by express prepaid to any part of the United States East of the Rockies.

SCHOVERLING, DALY & GALES

302-304 Broadway

NEW YORK

THE
DAVENPORT
1904 MODELS.

*The Productions of
over 50 YEARS of
Practical Experience.*

Catalogue
Free



Mention
RECREATION

The W. H. Davenport Fire Arms Co., Norwich, Ct.



We make a specialty of Featherweights
and Trap Guns with our new
SINGLE TRIGGER

Send stamp
for 1903 Catalogue
Mention RECREATION

D. M. LEFEVER SONS & CO.,

Manufacturers of the "NEW LEFEVER"

Not connected with Lefever Arms Co.

SYRACUSE, N. Y.

Guaranteed
Perfect

Our New
Perfect
Gun Cleaner
By Mail,
30 Cents

H. & R. SINGLE SHOT GUN

Automatic and Non-Ejecting

The cheapest absolutely safe gun, with improvements found heretofore only in the highest priced.

PERFECT IN MODEL
AND CONSTRUCTION

SIMPLEST "TAKE
DOWN" GUN MADE

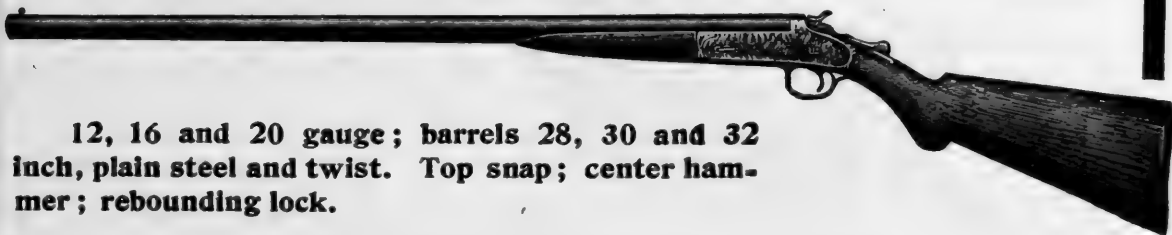

12, 16 and 20 gauge; barrels 28, 30 and 32 inch, plain steel and twist. Top snap; center hammer; rebounding lock.

Your dealer can supply, or we will sell to you direct. Write for Catalog.

HARRINGTON & RICHARDSON ARMS CO.

Dept. R, WORCESTER, MASS.

Makers of H. & R. Revolvers

RECREATION is not only the best sportsmen's magazine for the money, but covers fully 5 times the ground of any other I have been able to find.

C. B. Shiffer, Tilton, N. H.

Ice cream he bought his darling,
And she ate, and ate, and ate;
Till at last her heart she gave him,
To make room for one more plate.
—Harvard Lampoon.

The grouse season opens August 15. Fine shooting is anticipated by the local sportsmen, as large numbers of grouse are to be seen on the mountains. The new game law requiring a license to hunt or fish is meeting with good success and proves a remarkable barrier to market hunters by its limitations. Taken altogether Idaho furnishes as fine fishing and shooting grounds as can be found anywhere.

R. L. Brainard, Wardner, Idaho.

THE PARKER AUTOMATIC EJECTOR

The Latest attachment to
The "OLD
RELIABLE"



New York Salesroom, Send for Catalogue. PARKER BROS.,
32 WARREN ST. Mention RECREATION. Meriden, Conn.

A Holiday Present

FOR YOUR WIFE
YOUR MOTHER
YOUR SISTER
OR YOUR BEST GIRL

For 25 Yearly Subscriptions to RECREATION

I will send you a set of

1 DISH AND 12 TOMATO PLATES

made by HIGGINS & SEITER, 50 W. 22d St., N. Y.

LISTED AT - - \$19.50

AND

For 20 Yearly Subscriptions to RECREATION

I will send you a set of

12 Watermelon Plates

Listed at - - \$16.50

[See Illustration]



THESE are fine, thin, white china plates, beautifully hand painted, with pictures of tomatoes and tomato vines, or watermelons and watermelon vines, in natural colors, and each set of plates is enclosed in a case made in an exact imitation of a large tomato or a watermelon.

No more beautiful or appropriate present could possibly be

found for a lady than one of these sets.

You can earn one of them in a few hours, and at the same time earn the everlasting gratitude of the lady to whom you may give it.

Send for package of sample copies for use in canvassing.

Book 1 on Dyspepsia
 Book 2 on the Heart
 Book 3 on the Kidneys
 Book 4 for Women
 Book 5 for Men (sealed)
 Book 6 on Rheumatism

Which Book
 Shall I Send ?

Six Books For The Sick

Learn How to Get Well

The book will tell you
 How to get well at my risk.

Just ask me for the book.
 Don't send a penny. Let me take the risk.

As a physician—a specialist—I tempt you to try my prescription, Dr. Shoop's Restorative. I say "tempt" you, because to a sick one it must be a temptation—the offer I make. You cannot well resist it. How could I better show my faith than by saying "take the Restorative a month at my risk."?

My way to help is certain.

Is so certain, at least, that the expense is mine, not yours, if it fails.

Tell me in strictest confidence about your ailment. I will advise you. I will tell you of a druggist near you who will let you have six bottles

Dr. Shoop's Restorative A Month At My Risk.

If I succeed you pay \$5 50;

If you say to the druggist "it did not help me," he will bill the cost to me. I will tell him to do so.

But you will not say that. You will be glad to say what thousands are saying of Dr. Shoop's Restorative.



James Knowles, Wilmington, Delaware, writes:

"Brights Disease laid me on my back Oct. 12, 1902. Water flowed out through my slippers through a thousand breaks in the skin

The tension from dropsy caused the skin to break everywhere.

All physicians pronounced my case hopeless. Then I learned of Dr. Shoop's Restorative. After six bottles I began to feel better. The swelling began to subside. Fifteen bottles completely cured me. I have not been so well in twenty-five years. I am sixty-six years of age. I considered this medicine, coming into my hands, as a direct and overruling providence of that great God in whom I believe and place my trust. My physicians were astonished. My pen is ever ready to urge the use of Dr. Shoop's Restorative."

Physicians "shake their heads" when called to a case like Mr. Knowles.

J. N. Renfroe, 46 Granger St., Atlanta, Ga., writes:

"New York specialists pumped my stomach. Called it acid catarrh of the stomach. Treated me two years and failed.

I got six bottles Dr. Shoop's Restorative at the Jacob Pharmacy, Atlanta.

It was to cost me nothing if it failed. After four bottles, then came the change.

After six bottles I was eating most anything I desired. I am well now.

Dyspepsia nervousness gone. Use my letter privately or publicly, for I feel that this is as little as I can do to show my gratitude for the results you have brought in my case."

He used my Restorative because I took the risk. I make this same offer to you.

To-morrow never comes; write me to-day.

Say which book and address
 me Box 4214, Racine, Wis.

Rambler

Touring Cars



are simple in construction, powerful in operation; they are built to run smoothly, to ride easily.

Model "H," here illustrated, 81 inch wheelbase, four elliptic springs, detachable tonneau, brass side lamps and horn, \$850.00 at the factory.

For a light Touring Car, Model "H" has no equal at the price, and few equals at double the price.

Rambler Cars are made in six different models, \$750.00 to \$1350.00.

Shall we mail you our new catalog, illustrating each style and showing why you should buy a Rambler?

Thomas B. Jeffery & Co., Kenosha, Wis., U. S. A.

Chicago Branch, 334 Wabash Ave.

Boston Branch, 145 Columbus Ave.

Left From Our FIRE SALE. A few

High Grade Hammerless **GUNS**

SCOTT, GREENER

LANG and others

12, 16 and 20 Bores.

Trap and some very light weights.

26, 28 and 30 inch

which we are closing out at **Greatly Reduced Prices—BARGAINS.**

☞ Descriptive List with full description mailed on receipt of 2 stamps.

Also a lot of **AMERICAN HAMMERLESS DOUBLE GUNS**, pistol stock, through cross bolt, all improvements twist barrels, 28 and 30 inch, 12 bore, closing out at

\$19.50 each

These are entirely new, and bargains.

☞ Send 2 stamps for full list.

Mention RECREATION

Also our **Special Swedish Leather Jackets** in demand at this season

REDUCED PRICES IN A

L
o
t **Double Breech Loading Hammer Guns** \$8, \$10, \$12, e
t
c

WM. READ & SONS, 107 Washington Street, Boston

ESTABLISHED 1826

Send 2 Stamps for Lists



Morning, Noon, and Night Fast Trains to the West--VIA NEW YORK CENTRAL.

A
Y
E
L
L
O
W
W
O
L
F
E
Y
R
O
B
B
E
R
T
H
W
O
L
F
E
Y
R
O
B
B
E
R
T
H
W
O
L
F
E
Y



SAVAGE

RIFLES

"Ride cranks" and other sportsmen already have our rifles. Many of them have our rifles. We should like very much indeed to see you equipped with them if you are at all interested in fire-arms.

Correspondence solicited.

SAVAGE ARMS COMPANY,
Utica, N. Y.

Be'er & Hamilton, Pacific Coast Agents
San Francisco and Sacramento, Cal.

The Stuff
that brains
are made
of —

**Grape-
-Nuts**

"There's a
reason"

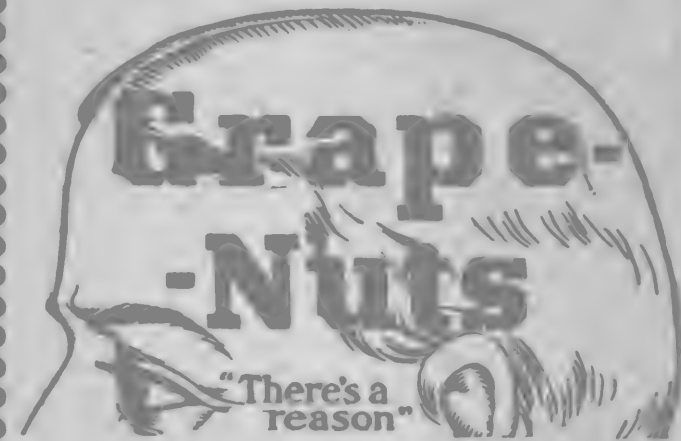

No Member of your Family
should be without an Individual Stick of

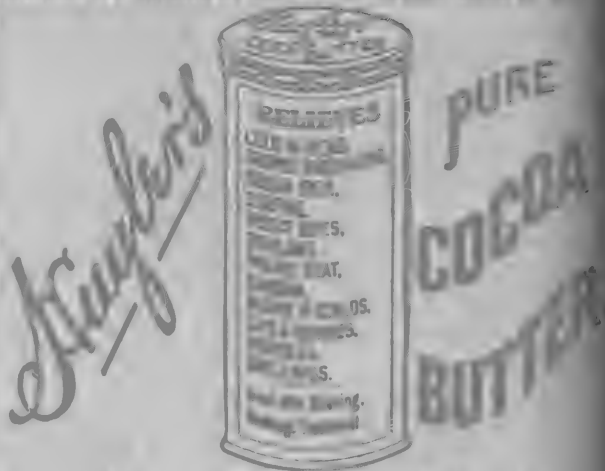

(10¢ POCKET TINS.)

Relieves Colds, Rough Skin,
Bruises, Soreness &c

ALL DRUGGISTS.

OR BY MAIL
ON RECEIPT OF PRICE
IN SILVER OR STAMPS.

Fryer's
843 BROADWAY, N.Y.

VOSE

PIANOS

have been established over 50 YEARS. By our system of payments every family in our country can own a VOSE piano. Write for catalogue D and explanations.

VOSE & SONS PIANO CO., 140 Bowdoin St Boston, Mass.

A Dengue-like Story of a Woman
SCHAVOIR, with full page drawing by W. H. LAWRENCE

Hunting White Goats in the Selkirks;





RECREATION

Copyright, December, 1903, by G. O. Shields

A Monthly Magazine Devoted to Everything the Name Implies

\$1.00 A YEAR.
10 CENTS A COPY.

G. O. SHIELDS (COQUINA),
Editor and Manager.

23 WEST 24TH STREET,
NEW YORK

CONTENTS OF THIS NUMBER

PAGE.

Imagine the Thrill of Jumping Over Stumps, Rocks and Other Obstacles on a Narrow Trail! FRONTISPIECE			
Hunting White Goats in the Selkirks.....	ELEANOR SCHAVOR	85	
Photographing in the Canadian Rockies. Illustrated.....	G. O. SHIELDS	89	
The True Story of the Nez Perce War.....	H. B. NORTON	99	
Fishing. Poem.....	EMMA G. CURTIS	101	
A Pioneer's Adventure.....	A. A. BRIGGS	103	
The Enchanters. Poem.....	GEORGE E. WINKLER	104	
Down the Arbuckle River.....	F. W. PORTER	105	
Antoine's Cat.....	E. W. PARKER	107	
Take Us Afar. Poem.....	JEANNETTE CAMPBELL	108	
A Pioneer Reminiscence.....	MISS M. L. SUTTON	109	
Buffalo Hunting in Kansas.....	STUBB	111	
The Haunted Mountain.....	MOSES THOMPSON, JR.	113	
The Pawnee Uprising of 1859.....	HOWARD W. BELL	115	
Hiawatha. Poem.....	JABOX	117	
The Hudson Bay Company.....	S. A. PADDOCK	118	
Veneered Human Nature.....	GRANT WALLACE	120	
Sea Trout Galore.....	GOLD DUST	122	
An Impson Valley Fox Hunt.....	R. J. LONG	123	
A Master of Theory.....	G. A. MACK	125	
From the Game Fields.....	127	Forestry.....	151
Fish and Fishing.....	133	Pure and Impure Foods.....	154
Guns and Ammunition.....	137	Publisher's Notes.....	157
Natural History.....	143	Editor's Corner.....	160
The League of American Sportsmen.....	147	Amateur Photography.....	166

Entered as Second-Class Matter at New York Post Office, Oct. 17, 1894.



ALL MEN
WOULD USE
WASHBURNE'S
PATENT IMPROVED

Cuff Holders

if they knew of their wonderful utility and comfort. Instantly attached or detached.
The Little Fastener with a Bull-Dog Grip, as applied to

Cuffholders 20 cents } Sent post paid
Key chain and ring 25 cents }
Scarfholders 10 cents }

Also 2 other useful novelties fully described in illustrated catalog.

Sent free on request.
Sold everywhere.

American Ring Co., Dept. 44, Waterbury, Conn.

Sore Throat

Hoarseness, Quinsy, Tonsillitis
Laryngitis and other throat
troubles quickly relieved
and promptly cured
by the use of

Hydrozone

This scientific germicide is used and endorsed by leading physicians everywhere. It is *absolutely harmless*, yet a most powerful healing agent.

By killing the germs that cause these diseases, without injury to the tissue, Hydrozone cures the patient. Sold by leading druggists. If not at yours, will send bottle, prepaid, on receipt of 25 cents.

Prof. Charles Harchand

F-59 Prince Street, NEW YORK
FREE.—Valuable Booklet on How to Treat Diseases.

Camping Out

Camping may be pleasant, or disagreeable or dangerous. The equipment has much to do with it. Expense may be large and results unsatisfactory, or small with good results. The "KNOW-HOW"—what to take, what to leave—has most to do in insuring the comfort, pleasure and safety of an outing expedition, be it to explore untraveled mountains, or to find the north pole, or just to spend a month in the woods.

Our business is to "KNOW-HOW." Our success leads us to believe that we have learned our business.

We manufacture and sell everything for outfitting camping parties. Let us send our Catalogue R, or better still, call on us, if you contemplate "smelling burning wood" before an open tent in the shadow of the woods.

ABERCROMBIE & FITCH

314-316 Broadway, New York

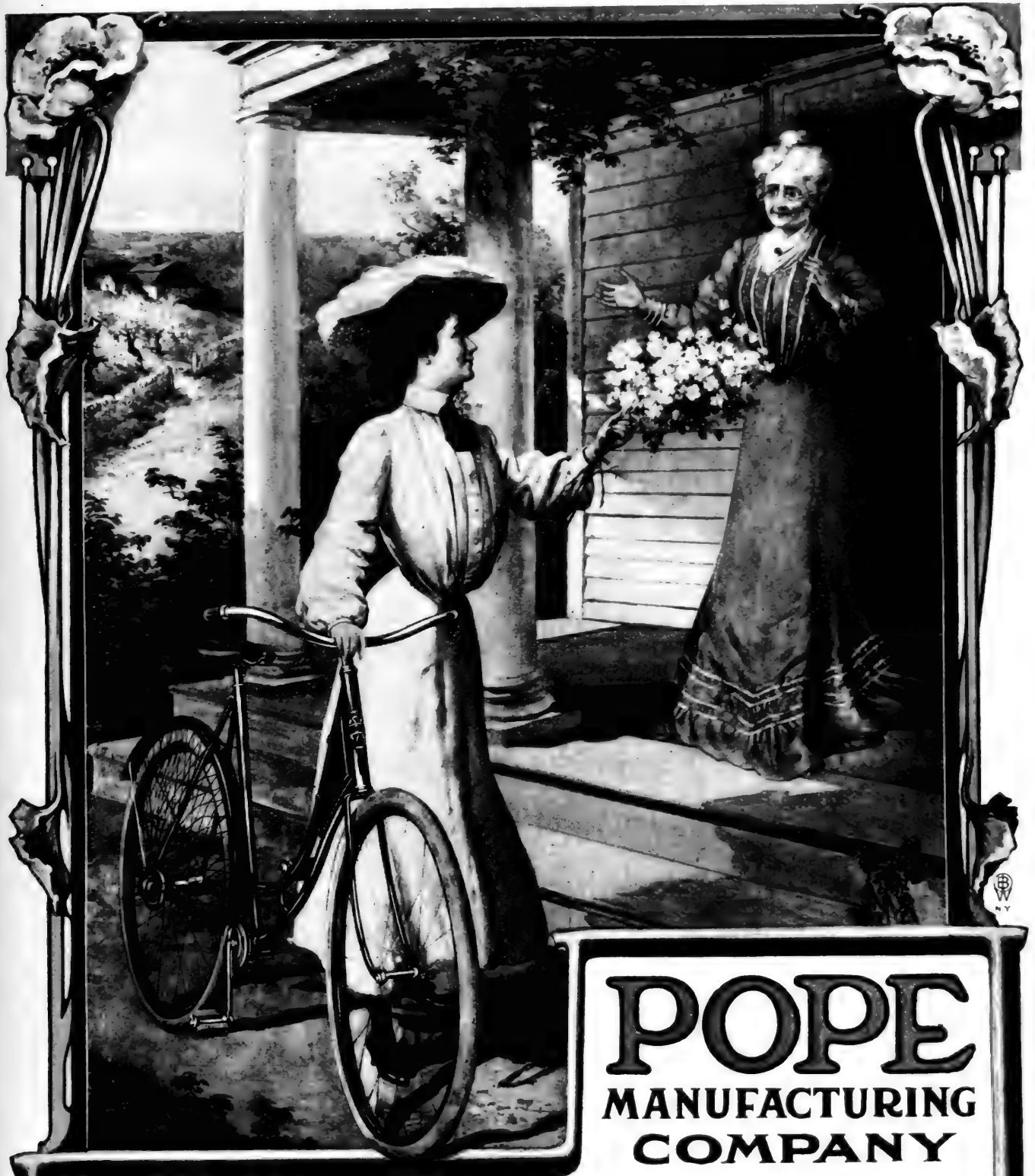

POPE
 MANUFACTURING
 COMPANY

Famous Chainless Bicycles

Equipped with two-speed gear, coaster brake, and cushion frame
 and All Standard Chain Models

Eastern Department, Hartford, Conn.

"Columbia" "Cleveland"

"Tribune" "Crawford"

Western Department, Chicago, Ill.

"Crescent" "Rambler"

"Monarch" "Imperial"

Catalogues free at our 10,000 dealers' stores, or any one Catalogue mailed on receipt of a two-cent stamp.

Fishing

On line of the

Bangor & Aroostook Railroad

For Trout, Togue,
Landlocked
Salmon,
Pickerel, Perch,
and Gamey
Black Bass

You will fail to know what "good sport" really is until you fish in the waters of NORTHERN MAINE. Season opens early in May.

Canoeing

On line of the

Bangor & Aroostook Railroad

In Northern
MAINE is
IDEAL.

West Branch Trip,	80 miles
Allagash Trip,	203 miles
East Branch Trip,	118 miles
Van Buren Circuit,	111 miles
Allagash Lake Trip,	99 miles
Pine Ponds Trip,	27 miles
St. John Trip,	231 miles

Camping

On line of the

Bangor & Aroostook Railroad

In the Woods
of MAINE.

Take a CAMPING TRIP in the Maine woods and enjoy a new sensation.

Enjoy the fishing and canoeing as well. Through Pullman Parlor and Sleeping Cars from Boston during summer and fall.

Guide Book

"In the Maine
Woods,"

Published by the

Bangor & Aroostook Railroad

Entirely new for 1904. Ready in April. Book of 175 pages, finely illustrated by over 100 half-tone cuts of scenery, live game, etc., and with several pages in color. Describes the fishing, hunting, camping, canoe trips, and life in the Big Maine Woods.

Copy Mailed for 10c. in Stamps.

Address: **GEO. M. HOUGHTON,**
Traffic Manager,
Bangor, Maine.

Mention RECREATION.

PINEHURST NORTH CAROLINA

(FOUNDED BY JAMES W. TUFTS)

*The HEALTHIEST and MOST
PERFECT RESORT in the SOUTH*

**Four Splendid
Hotels
Fifty Cottages**

**Two Excellent
Golf Courses**

PINEHURST is in the center of the sandy **LONG-LEAF PINE REGION** and enjoys a climate which offers a happy medium between the enervating qualities of the extreme South and the rigorous winter of the North.

THE HOTELS OF PINEHURST are all under one management and vary in rates from \$12.00 per week up. Cottages rented by the season.

THE GOLF COURSES are, by common accord, the best in the South, the annual North and South Championship Tournament being held at Pinehurst every year. Golf, shooting and tennis tournaments weekly.

25,000-ACRE SHOOTING PRESERVE. Fine livery, equipped with saddle horses, horseback riding being one of the features of Pinehurst.

PREPARATORY SCHOOL under direction of Prof. Aldice G. Warren.

PINEHURST is a private estate about ten miles square, ranking among the leading properties in the South in size and attractiveness. It has an altitude of about 1,000 feet above sea level. Among its many natural charms is the large percentage of bright, sunny days and its freedom from damp, penetrating winds.

PINEHURST is the only resort in America from which **consumptives are absolutely excluded.**

Through Pullman service. One night out from New York, Boston and Cincinnati, via Seaboard Air Line or Southern Railway.

Send for beautiful pamphlet, "Pinehurst," or "The Game at Pinehurst," or both.

Address

**PINEHURST
GENERAL
OFFICE**

*Pinehurst,
N. C.*

**LEONARD
TUFTS**

*Owner
Boston, Mass.*



Decorate Your Den

With a set of the most beautiful
Hunting and Fishing Pictures
 ever made.

15 Plates. Size for Framing, 18 x 24 inches

SUBJECTS :

ELK HUNTING, SALMON FISHING,
MOOSE HUNTING, TROUT FISHING,
 HY. SANDHAM.

MALLARD SHOOTING,
BLACK BASS FISHING,
 C. E. DENTON.

TARPON FISHING, BLUE FISHING,
 FRED. S. COZZENS.

ANTELOPE HUNTING,
GOOSE SHOOTING,
 FRED. REMINGTON.

GROUSE SHOOTING,
WILD TURKEY HUNTING,
 R. F. ZOGBAUM.

MUSKALONGE FISHING,
 F. H. TAYLOR.

DEER HUNTING,
 A. B. FROST.

ROCKY MOUNTAIN SHEEP HUNTING,
 E. KNOBEL.

These 15 plates are lithographed in the true colors of nature and altogether make one of the finest series of pictures of outdoor sports ever published

ORIGINALLY ISSUED AT \$50 A SET.

I have bought the last of them and can furnish a complete set for 15 yearly subscriptions to RECREATION.

Or will sell at \$10 a set.

Address, RECREATION, 23 West 24th Street, New York City.



From Puppyhood to Doghood

A dog is subject to many ills, liable to various diseases. Sickness attacks the average dog as often and in much the same way as it attacks the average man. He contracts a cold from exposure or sudden changes in the weather, which, if not cured, is liable to develop distemper. Sometimes, from over-eating or improper diet, his digestive organs become deranged, he suffers from indigestion, constipation and biliousness. The various ills that assail dogs, each has its counterpart in human maladies.

The one great, over-towering remedy of the dog world, the medicine that cures nearly all canine ills, is

Sergeant's Condition Pills

This remarkable medicine has been the means of saving more dogs' lives than any other remedy on the market. It cures indigestion, nervousness, general debility, insomnia, meanness, mange, distemper, chills and fever, and other diseases common to dogs. It is a tonic and alterative, puts the entire system in good shape, creates appetite, gives strength, life, and vim.

Large box, \$1.00; small, \$.50

On sale at druggists and sporting goods dealers, or sent postpaid to any address upon receipt of price.

Sergeant's Sure Shot Destroys Worms

When you see a full grown dog with a dead-looking coat of hair, coagulated matter around the eyes, dull, sleepy look, lazy gait, and an appetite which no amount of feeding will satisfy—that dog is wormy.

Worms in puppies produce nausea, colic, pains, restlessness, feverishness and fits, stunt the growth, and in the majority of cases, if not destroyed, soon kill the puppy. Sergeant's Sure Shot is a sure destroyer of all canine worms. In thousands of cases it has been successful, and not once has it failed. It is quick, sure and harmless.

Price, \$.50, postpaid to any address

Send 3 cents for postage and we will send you our handsome Dog Book and a Pedigree Blank, free. Write to-day. We will send any of our dog remedies on receipt of price, if your druggist cannot supply you.

POLK MILLER DRUG CO., RICHMOND, VA.

For Hunters, Anglers, Prospectors, Ranchmen, The Press Button Knife

IS THE THING.

A single pressure of the button opens it. It locks open, cannot close on the fingers, saves the finger nails, has 2 blades hand-forged from Wardlow's best English steel, and is in every respect as good a knife as can be made. Ladies' and Gentlemen's sizes in Stag Shell or Ivory handles, including moisture-proof Chamois case securely mailed to any address for **75 CENTS.**

Send for catalogue K for description and prices of other styles.

**THE
NOVELTY
KNIFE CO.**

**426 East 52d Street,
NEW YORK.**

And all others who go
into the Woods or Hills

Our 5-inch Press Button Hunting Knife can not be excelled. Can be opened with one hand, and will not open or close accidentally.

Handsome Stag Handle

Price, One Dollar

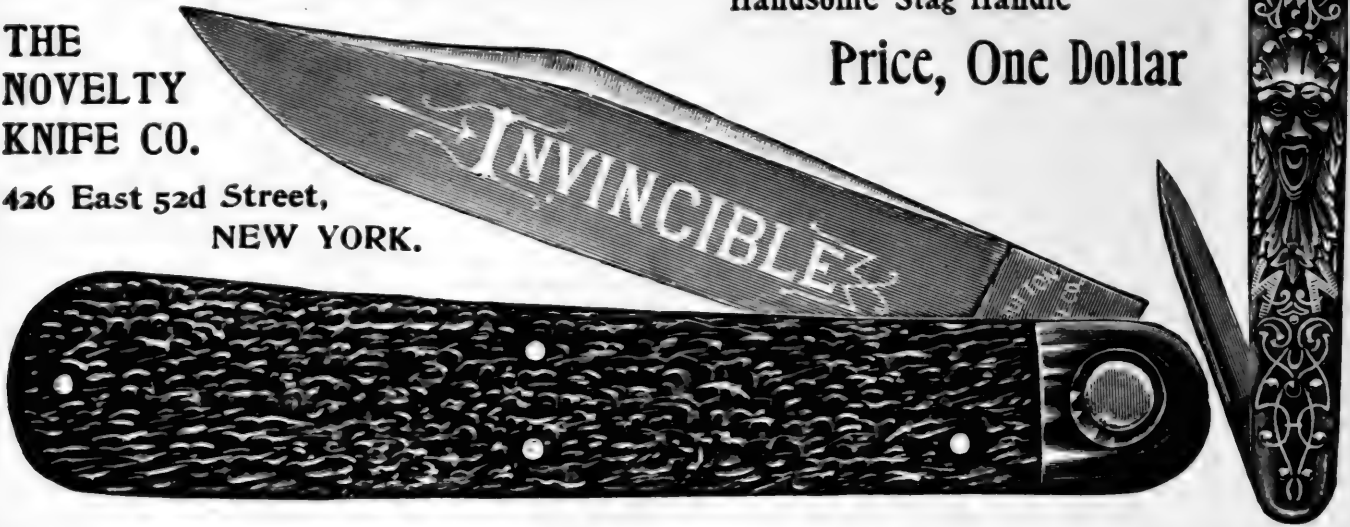

SOUTHERN RAILWAY

TO ALL THE
PRINCIPAL
CITIES AND
RESORTS
South,
Southeast,
Southwest,
Florida,
California,
Cuba,
Mexico
and Central
America.

"The Land of
the Sky" and
"Sapphire
Country"

Pullman Draw-
ing and State-
room Sleeping
Cars; Dining

Library and Observation Cars of the
Highest Standard. The Route of the
Washington & Southwestern
Limited and Sunset Limited
New York and New Orleans, Los Angeles,
and San Francisco.

The Southern's Palm Limited
New York and St. Augustine.

Write for Descriptive Matter
NEW YORK OFFICES: 271 & 1185 Broadway
ALEX. S. THWEATT, Eastern Passenger Agt.
W. A. TURK, - Passenger Traffic Manager
S. H. HARDWICK, General Passenger Agent
WASHINGTON, D. C.

"Where every prospect pleases."

FIVE
POINTS
OF EXCELLENCE.

Leaving the center of the city from which you start; reaching the center of the city of your destination; over smooth and level tracks; giving rest and comfort; riding beside running waters most of the way; through the centers of population to the gateways of commerce; when you travel by the

NEW YORK CENTRAL LINES

A copy of the 52 page Illustrated Catalogue of the "Four Track Series" will be sent free upon receipt of a two-cent stamp by George H. Daniels, General Passenger Agent, New York Central & Hudson River Railroad, Grand Central Station, New York.



Battle Scene

Flemish Stein, No. 96515½ in. high, raised figures in
ivory, dark background, \$3.75

HIGGINS & SEITER

Fine
China

Rich Cut
Glass

If you would like to be thoroughly well
informed as to

CHINA and GLASS

with a view to obtaining it from the
largest collection in the world, at

"¼ Less than Elsewhere"

send for our Catalogue 14U, carrying
more than a thousand illustrations.

"Serving a Dinner," an elegant bro-
chure by "Oscar," of the Waldorf-
Astoria, also sent free to those really
interested.

West 21st and West 22d Streets
Near Sixth Avenue NEW YORK CITY

"Buy China and Glass Right"

Paroid Roofing

"IT LASTS"

The most economical roofing
made. Does not require a
skilled roofer. Easy to apply
with roofing kit in each roll.
No repairs. No paint re-
quired when first laid.

F. W. Bird & Son

Makers

EAST WALPOLE, MASS.

New York Washington Chicago

COLUMBIA Typewriter



THE ideal machine for operators, *be-
cause all* its writing is at all times
Visible, and *because* it is *the
Specialist in automatic movements*.
Many operations necessarily manual on other
typewriters are entirely automatic on the
Columbia. It is *the* labor saver among
Typewriters.

THE COLUMBIA TYPEWRITER MFG. CO.
53 WEST 116th STREET
NEW YORK CITY, N. Y.

Rare and Valuable Books

I have for sale a few bound copies of Vol. III of RECREATION, July to December, inclusive 1895; also of Vols. IV and V. including the entire issues of 1896; Vols. VII, VIII, XII, XIII, XVI, XVII, and XVIII. All these are filled with interesting and valuable matter. The intervening volumes, are nearly all out of print, and can never be replaced at any time.

Vol. III sells at \$2.

Vols. IV and V, one book, at \$3.

All others \$2 each.

Here are a few titles that will suggest the value of these rare books, to lovers of fields and sports:

The San Juan Islands.....	Maj. John Brooke, U.S.A.
The Lord Eagle of the Storm.....	Chief Simon Pokagon.
The Cowboy and the Wheel.....	James B. Adams
Two Moose and Three Bear.....	Dr. Hamilton Vreeland
Hunting Big Game with a Camera.....	George Shiras, 3d
The Fight on Soppa Creek.....	Capt. Wheeler, U.S.A.
My Best Shot.....	Hon. W. A. Richards, ex-Gov. of Wyo.
A Prairie Pastoral.....	E. L. Kellogg
Woodcock on the Islands.....	F. W. G. Johnson
Crossing the Rockies in '61.....	Major W. H. Schieffelin
Salmon Fishing in Labrador.....	Col. Charles E. Fuller
Coursing with Greyhound.....	L. F. Bartels
A Bald-Faced Grizzly in Camp.....	M. W. Miner
A Deer Drive with Spokane Indians.....	Lieut. W. R. Abercrombie
Pheasant Shooting.....	Thomas G. Farrell
Sitting Bull's Last Medicine.....	Margaret G. Brooks
A Mountain Lion Hunt.....	Dr. Robert Meade Smith
Trouting on Clark's Fork.....	Gen. F. W. Benteen, U.S.A.
A Youthful Guide and a Prize Bighorn.....	Hon. I. N. Hibbs
The First Day of the Chicken Season.....	A. B. Cowie
Goose Shooting in Colorado.....	W. E. King
The Cowboy's Version of the Prodigal Son.....	Pony Bill
Trouting on the Thunder.....	A. D. Curtis
A Bad Grizzly.....	George W. Kellogg
My Wife's Moose.....	W. E. Bemis
How We Photographed the Wild Cat.....	Coyote Bill
Elkland	Ernest Seton-Thompson
Hunting Mountain Sheep in a Snowstorm.....	Capt. S. A. Lawson
Grouse in New Hampshire.....	Old Bill
Foxes in the Big Swamp.....	C. P. Franklin
On the Chilkat Pass.....	H. L. Suydam
A Rangeley Vacation.....	C. J. Halpen
Pierre's Stratagem.....	H. D. Leadbetter.

There are many other stories in the books equally interesting. You should enrich your library at once by adding to it one of each of these rare volumes.

Have You Read
Betty Zane?

*If not there is in store for you one of
the greatest literary treats of your life*

This book deals with the history of the first settlement made by white men on the ground where the city of Wheeling, W. Va., now stands. The story portrays in a most thrilling and effective manner a phase of pioneer life in the Middle States 140 years ago, of which too little has been written.

It describes one of the bloodiest fights of the Revolution and several important Indian Wars, throughout which the handful of pioneers, who built and defended Fort Henry, exhibited to the world that wonderful courage, fortitude, self-reliance and skill in the use of the hunting rifle, which delivered the American colonies from the thraldom of British rule, under which they had lived 2 centuries.

Betty Zane

is destined to become one of the great standard historical novels of the day, and no man or woman who is interested in the study of the pioneer life of the Middle West, in the history of the Indian wars, or in the wonderful feats of the wilderness hunters of those days, can afford to forego a careful reading of this book.

Price, \$1.50

Published by the CHARLES FRANCIS PRESS
30 West Thirteenth Street
NEW YORK

In ordering please mention RECREATION.

"FOR 36 YEARS A STANDARD PIANO."

THE WING PIANO

YOU NEED THIS BOOK IF YOU INTEND TO BUY A PIANO. A book—not a catalogue—that gives you all the information possessed by experts. It makes the selection of a piano easy. If read carefully, it will make you a judge of tone, action, workmanship and finish; will tell you how to know good from bad. It describes the materials used; gives pictures of all the different parts, and tells how they should be made and put together. It is the only book of its kind ever published. It contains 116 large pages and is named **The Book of Complete Information about Pianos**. We send it free to anyone wishing to buy a piano. Write for it.

SAVE FROM \$100 TO \$200 We make the WING PIANO and sell it ourselves. It goes direct from our factory to your home. We do not employ any agents or salesmen. When you buy the WING PIANO you pay the actual cost of construction and our small wholesale profit. This profit is small because we sell thousands of pianos yearly. Most retail stores sell no more than twelve to twenty pianos yearly, and must charge from \$100 to \$200 profit on each. They can't help it.

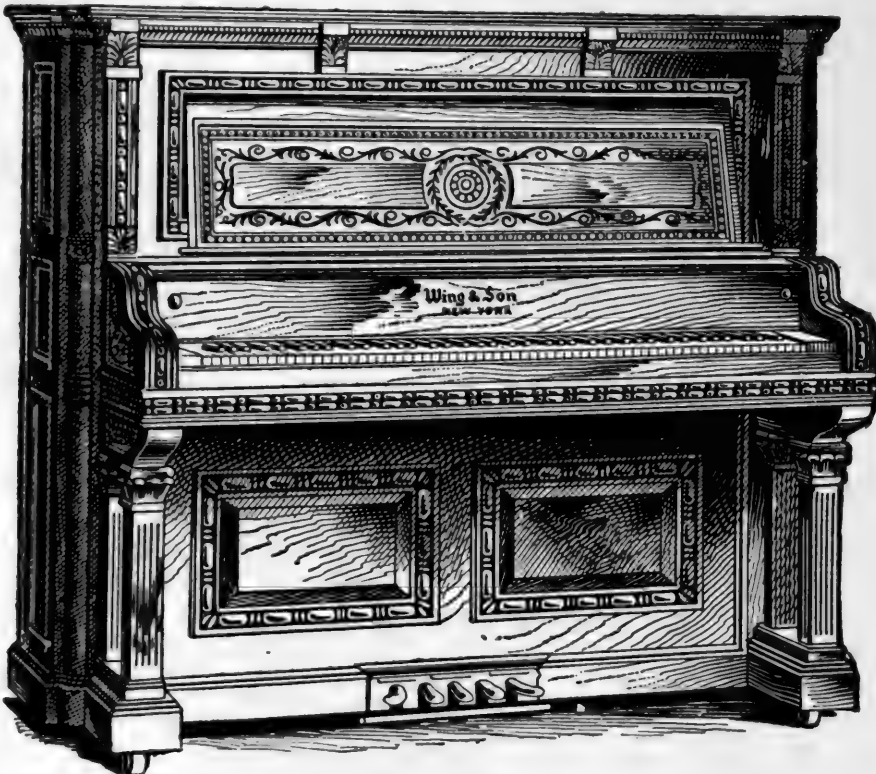

A Wing style—45 other styles to select from.

SENT ON TRIAL WE PAY FREIGHT. NO MONEY IN ADVANCE. We will send any WING PIANO to any part of the United States on trial. We pay freight in advance, and do not ask for any advance payment or deposit. If the piano is not satisfactory *after twenty days' trial in your home, we take it back entirely at our expense.* You pay us nothing unless you keep the piano. There is absolutely no risk or expense to you.

Old instruments taken in exchange. **EASY MONTHLY PAYMENTS.**

INSTRUMENTAL ATTACHMENT A special feature of the Wing Piano; it imitates perfectly the tones of the mandolin, guitar, harp, zither and banjo.

IN 34 YEARS, 33,000 PIANOS We refer to over 33,000 satisfied purchasers in every part of the United States. WING PIANOS are guaranteed for twelve years against any defect in tone, action, workmanship or material.

WING ORGANS Are just as carefully made as Wing Pianos. They have a sweet, powerful, lasting tone, easy action, very handsome appearance, need no tuning. Wing Organs are sold direct from the factory, sent on trial; are sold on easy monthly payments. For catalogue and prices write to

WING & SON. 350 to 356 West 13th St.,
NEW YORK.

1868 —36th Year—1904.

Backed by a Record of 50 Years

1854 1855 1856 1857 1858 1859 1860 1861 1862 1863 1872 1873 1884 1885 1886 1887 1888 1889 1890 1891 1892 1893 1894 1895 1896 1897 1898 1899 1900 1901 1902 1903

TRADE MARK

Time proves or disproves all theories. Fifty years is long enough to find out whether a mattress is good, bad or indifferent. Notwithstanding the attacks by makers of worthless imitations, the

Ostermoor Patent Elastic Felt Mattress \$15.

has stood the test. Over one million (1,000,000) are in use to-day. It is the standard which fraudulent competition has vainly tried to reach. It's not *Felt* if it's not an *Ostermoor*. We honestly believe that nothing could be added to make it better--nothing could be taken away without doing harm.

30 Nights' Free Trial

Sleep on the OSTERMOOR thirty nights free and if it is not even all you have hoped for, if you don't believe it to be the equal in cleanliness, durability and comfort of any \$50. hair mattress ever made, you can get your money back by return mail—"no questions asked."

- 2 feet 6 inches wide, 26 lbs. \$8.35
- 3 feet wide, 30 lbs. 10.00
- 3 feet 6 inches wide, 35 lbs. 11.70
- 4 feet wide, 40 lbs. 13.35
- 4 feet 6 inches wide, 45 lbs. 15.00

All 6 feet 3 inches long.

Express Charges Prepaid.

In two parts, 50 cents extra. Special sizes at special prices.

It is no discredit to admit that we occasionally receive complaints; but our treatment of them is sufficient to warrant complete confidence. Only six people wanted their money back last year—but they got it without argument.

Send for Book Mailed FREE

Our 96-page illuminated book, "The Test of Time," treats exhaustively the mattress question, and gives scores of letters as strong (or stronger) than the one we print here. It also describes and beautifully illustrates OSTERMOOR Cushions and Pillows for Window Seats, Cozy Corners and Easy Chairs; Boat Cushions, Church Cushions—we have cushioned 25,000 churches. It is an encyclopædia of comfort and good taste—may we send it? Your name on a postal will do. Please send for it to-day, lest you forget.

Satisfied 47 Years

BLACKSTONE, VA., Dec. 14, 1903. MESSRS. OSTERMOOR & CO.

Gentlemen:—The OSTERMOOR Mattress bought by my grandfather, T. Freeman Epis, of Blackstone, in June, 1856, forty-seven years ago, is still in use, and as good as new to-day, and has had no renovation of any kind, except that the tick has been taken off and washed.

This Mattress has had harder usage than many, for it has been lain upon at least twelve hours every day for the past forty-seven years.

We had always spoken of it as an exceptionally fine hair mattress, and it was only when ticking was taken off for washing, some four years ago, that your label was discovered. A new one I purchased at that time has proven to be fully as good, if not better, than the original one.

We are delighted with OSTERMOOR Mattresses. These many years' experience have proved their everlasting comfort.

MRS. R. F. DILLARD.

Look Out! Dealers are trying to sell the "just as good kind." Ask to see the name "OSTERMOOR" and our trade-mark label, sewn on the end. Show them you can't and won't be fooled. It's not *Felt* if it's not an *Ostermoor*. Mattresses expressed, prepaid by us, same day check is received. Estimates on cushions and samples of coverings by return mail.

OSTERMOOR & COMPANY, 114 Elizabeth Street, New York

Canadian Agency: The Alaska Feather and Down Co., Ltd., Montreal

UNCLE SAM SAYS IT'S ALL RIGHT.

Uncle Sam in the person of Ten Government Officials, has charge of every department of our distillery. During the entire process of distillation, after the whiskey is stored in barrels in our warehouses, during the seven years it remains there, from the very grain we buy to the whiskey you get, Uncle Sam is constantly on the watch to see that everything is all right. We dare not take a gallon of our own whiskey out of our own warehouse unless he says it's all right. And when he does say so, that whiskey goes direct to you, with all its original richness and flavor, carrying a **UNITED STATES REGISTERED DISTILLER'S GUARANTEE OF PURITY and AGE**, and saving the dealers' big profits. That's why **HAYNER WHISKEY** is the best for medicinal purposes. That's why it is preferred for other uses. That's why we have half a million satisfied customers. That's why **YOU** should try it. Your money back if you're not satisfied.

HAYNER WHISKEY

1 QUART \$1.00

4 QUARTS \$3.20

WE PAY EXPRESS CHARGES IN EITHER CASE.

Send us **\$1.00** for **ONE QUART** or **\$3.20** for **FOUR QUARTS** of **HAYNER SEVEN-YEAR-OLD RYE**, and we will pay the express charges. We ship in a plain, sealed package; no marks to even suggest contents. If you don't find it all right and better than you can buy from anybody else for double the money, ship it back to us at our expense and your money will be promptly refunded. We ship one quart on your first or trial order only. All subsequent orders must be for at least 4 quarts at 80 cents a quart. The packing and express charges are almost as much on one quart as on four and even at \$1.00 for one quart we lose money, but we want you to try it. **WE PREFER TO HAVE YOU ORDER FOUR QUARTS FOR \$3.20 RIGHT NOW FOR THEN WE WILL MAKE A LITTLE PROFIT AND YOU WILL ALSO SAVE MONEY.**

Trial orders for Ariz., Cal., Col., Idaho, Mont., Nev., N. Mex., Ore., Utah., Wash., or Wyo., must be 1 Quart for \$1.25 by EXPRESS PREPAID. Subsequent orders on the basis of 4 QUARTS for \$4.00 by EXPRESS PREPAID or 20 Quarts for \$16.00 by FREIGHT PREPAID.

Remit by Check, Bank Draft, Express or Money Order. It is unsafe to send currency unless you register your letter. Write our nearest office and do it NOW.

ESTABLISHED
1866.

THE HAYNER DISTILLING COMPANY,

DISTILLERY
TROY, OHIO.

DAYTON, OHIO.

ST. LOUIS, MO.,

ST. PAUL, MINN.,

ATLANTA, GA.,



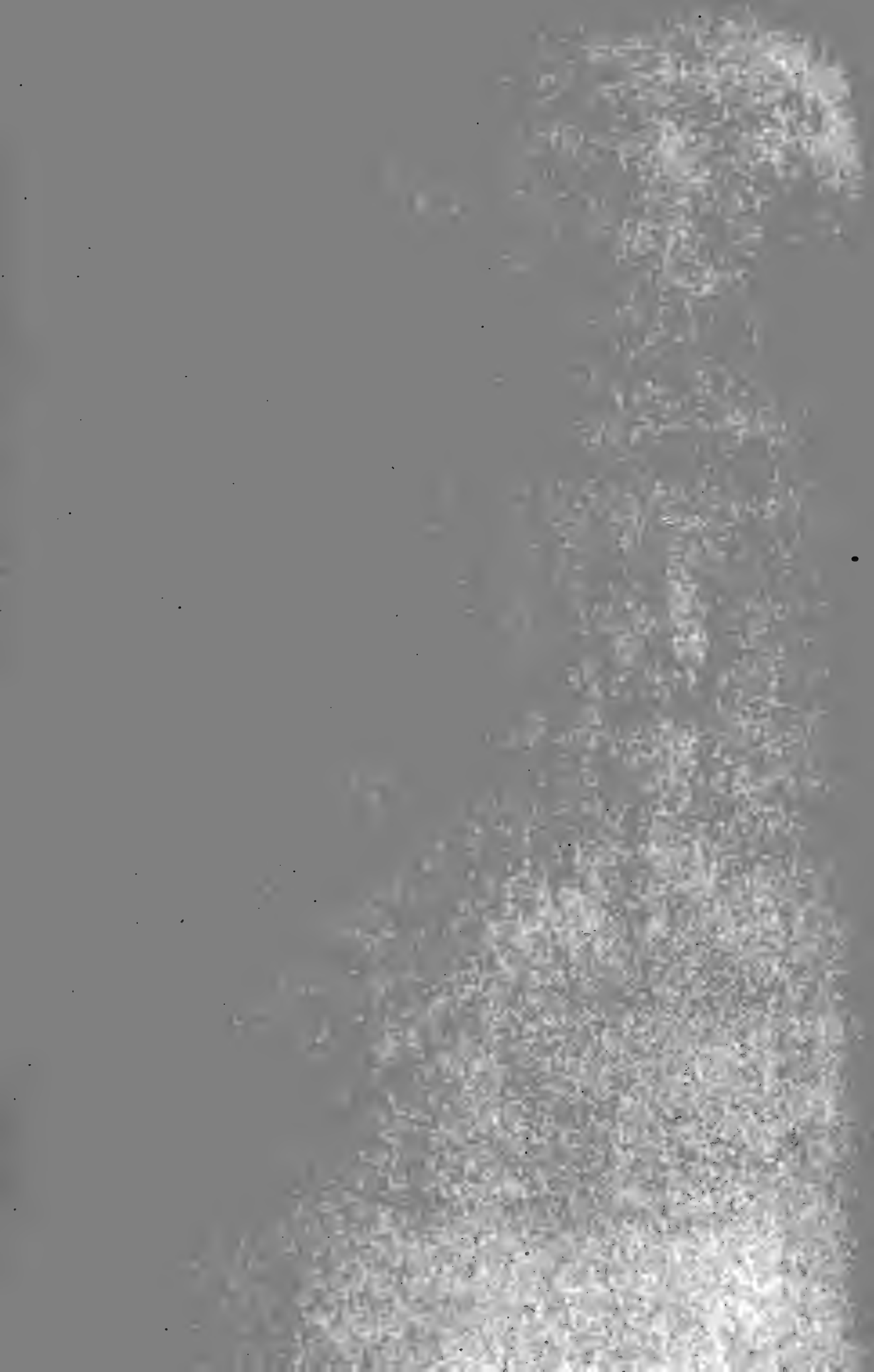



IMAGINE THE THRILL OF JUMPING OVER STUMPS, ROCKS, AND OTHER OBSTACLES
ON A NARROW TRAIL!

RECREATION

Volume XX.

FEBRUARY, 1904

Number 2

G. O. SHIELDS (COQUINA), Editor and Manager

HUNTING WHITE GOATS IN THE SELKIRKS.

ELEANOR SCHAVOIR.

In planning our annual hunting trip for the fall of 1902, my husband, Doctor Schavoir, and I decided to entrust matters to Mr. W. H. Wright, of Spokane, Wash., whose acquaintance we had made at the Sportsman's Show in New York. An editorial in the September number of RECREATION describes Mr. Wright's qualifications, and we both endorse every word said in his praise. We started from New York City for British Columbia August 17 and reached New Denver, B. C., Friday, August 23. A prettier place can hardly be imagined, and it is properly called the Luzerne of America. Slocan lake is a magnificent sheet of water, abounding in picturesque shore scenery. Fishing is excellent, trout of 5 different varieties being numerous and easily taken.

At New Denver we made up our outfit, consisting of 6 pack and 4 saddle horses. On striking the trail, the difficulties of hunting in the mountains were brought home to me at once, and I became convinced that it would be no child's play to obtain game in such a wild region. The dwellers in a flat country can never imagine what traveling in the mountains means. The trail was never more than 2 feet wide; in some places not half of that. On one side a steep cliff arose, while a bottomless pit yawned on the other, and a stout heart or long habit is required to retain calmness. If only the trail had been clear and unobstructed our hardships would have been less; but the storms of winter and the snow slides of spring had played havoc with it, and many a

weary wait did we have while Mr. Wright cleared away tree trunks lodged across our path. With his usual luck, my husband got the quieter horse, which stepped carefully over obstructions; while my mount, with probably a life's ambition to become a steeplechaser, persisted in clearing everything with a bound. Imagine the thrill of jumping over stumps, rocks and other obstacles on a narrow trail! However, the brave little horse always landed on his feet and the trail at the same time, and as he seemed indifferent to my feelings I concluded I might as well let him have his own way. After a while I grew so accustomed to that style of locomotion that I began to notice the scenery, and it was grand, indeed. Glaciers and enormous mountains surrounded us in all directions, a wild, rushing torrent dashed at our feet, and beautiful woods grew all around us.

We covered 32 miles in that fashion, and arrived in the afternoon of the second day at a charming spot about 7,000 feet above sea level. During the last 12 miles of our ascent the trail was conspicuous by its absence. In crossing a stream I tried to follow Mr. Wright, who descended the bank by clinging to some alder brush in order to choose a place for us to cross. Feeling sure, after what I had seen, that a horse can go where a man has passed, I rode to the bank and slid down about 20 feet to the river bed. Mr. Wright was startled, and both he and I motioned to my husband not to follow. He, however, imagining that I had slid down the bank for a dare,

with characteristic masculine obstinacy forced his horse to the brink, and luckily got down without mishap. It did not take more than half an hour to pitch our camp, and we were comfortably established in our tents, hardly realizing that we were settled for some time. Mr. Wright's contrivances to promote our comfort were a constant source of agreeable surprise to us. Our large tent took on an air of home which can not be appreciated by anyone who has not camped out in a howling wilderness, miles from any human habitation.

Another factor to make our stay pleasant was our good cook, Casteel. He was a prize. How he concocted the many tempting dishes he served us, with the material at hand, was a never ending wonder to us, and right well did we enjoy our meals.

Our first night in camp was rather startling, owing to the neighborliness of the porcupines which inhabit that country. A delegation of them waited on us in the small hours of the morning, evidently bent on investigating our social status. None of my lady acquaintances was ever so inquisitive as these porcupines. Nothing belonging to us was overlooked, and as we had failed to leave the tent flaps open, our visitors gnawed holes in the sides of the tent. Attempts to drive these creatures off by shouting were useless, and were taken simply as an invitation to closer intimacy. One big fellow managed to effect an entrance, and the Doctor swore he would have his blood for such trespass. Grabbing a 22 caliber Winchester rifle, the Doctor gave an exhibition of marksmanship most wonderful to behold, notwithstanding my constant encouragement and suggestions. The only impression on the porcupine was to make the animal sneeze, and I have since come to the conclusion that it was the brute's way of expressing his opinion of that shooting. Exasperated, and at his wit's end, the Doctor turned the gun around and clubbed Mr. Quilly

on the head. There my brave defender's aim proved more satisfactory, and the invader of our happy home was ejected as a corpse without further ceremony. Two fox terriers, which accompanied us, and which kindly consented to share our tents and beds, did their best thereafter to keep porcupines at a respectful distance. Their efforts were met by a blank refusal to keep off. When the dogs tried to back their arguments by attacking the unwelcome visitors, they got their hides full of quills, and it was my daily as well as nightly duty to extract the barbed torments from the faces, chests and flanks of our faithful canines.

The second day Mr. Wright started on an exploring trip, and on his return late in the afternoon reported that he had seen a number of fresh bear signs and workings. He also brought in the cheering news that he had met a large number of porcupines, all headed for our camp. Not having more than a case of ammunition on hand, the Doctor concluded to try clubbing the invaders, and during a 2 weeks' stay 27 victims were thus dispatched. There seems to be no other way, unless one is willing to have all his belongings chewed up. We were told the adventure of one hunter who had the brim of his hat chewed off by a porcupine while taking an afternoon nap in the sun. This tale we might have taken with a grain of salt had not our own experience convinced us of its probability.

During the next few days we saw several small groups of mountain goats near the crests of the surrounding mountains, and it was decided that we should try our luck on them. Accordingly we started one fine morning, shortly after breakfast. Our estimating of the distance which we would have to go and the time in which we thought we could do it elicited a knowing wink between Mr. Wright and Casteel; and the climb took about 3 times as long as we had expected. It

was a laborious undertaking and dangerous, for a misstep or a slip might have proved disastrous to life and limb. There was a crust of snow which made the going more risky, but we all reached the summit safe.

Some strategy was necessary to approach our quarry, but Mr. Wright was fully equal to the occasion. He posted us directly over a small troop of goats, and after taking a needed breathing spell, we approached our game. When within about 250 yards we each selected a specimen, and fired at the same time. Both shots proved effective, and we watched the remainder of the flock flee in all directions. The Doctor could not resist the temptation to try for another kill, and the way bullets flew around that mountain peak must have been a good imitation of the storming of San Juan hill. Another luckless goat became a victim of this fusillade, though if every shot had proven a hit not one goat would be left in that region.

Mr. Wright and I watched the striking of the Doctor's bullets, and both noticed that nearly every shot was low. When the Doctor's nerves had quieted sufficiently for him to hear what was said, we called his attention to the low shots. He explained to us that he had read in Van Dyke's works on deer hunting how shots fired from above would always pass over the animal fired at. He had therefore fired low deliberately and in good faith. This was fortunate for the goats, but considerably shook the Doctor's faith in hunting by the book.

We dragged the carcasses to a convenient spot, where we took off the heads and skins. Then began the hardest part of the day's work, the descent. Going up was laborious and

dangerous; going down was twice as hard. Burdened as we were with our trophies, we had to proceed with the utmost caution. When within 1,000 yards from our camping ground, we had to pass through an alder thicket. Suddenly I heard a grunt, a snort and a breaking of sticks, not 20 feet to my left. My first impression was that the Doctor had lost his footing and was rolling down the hill. However, the grunt was in a lower key than I was used to, and presently Mr. Wright said I had jumped a grizzly. Unfortunately the brush was so dense that I could not see the bear, which we could hear tearing through the bushes as if he had some pressing business in the next county.

We reached our tents late in the afternoon and devoted our attention to a square meal, followed by a blissful sleep, which not even a porcupine could disturb.

There are many grizzlies in that country but the jungle is so dense and the land so absolutely on edge that it is simply impossible to stalk them. Another hunter, who was in there with Wright ahead of us, said, after a day of hard climbing and prospecting of the many signs,

"Why, Wright, there will be bears here 100 years from to-day."

Our trophies are now ornamenting our house, together with moose, caribou and deer heads, which we have taken on former hunts. Never did I enjoy a hunting expedition more, and never did I bear hardships with greater cheerfulness, for the finest sport is to be had in those glorious mountains, and well deserved is a trophy when obtained in that grand and rugged country.

Before marriage men pay compliments;
after marriage, bills.—*Life*.



GLACIER CREEK CHASM.

See page 97.

PHOTOGRAPHING IN THE CANADIAN ROCKIES.

G. O. SHIELDS.

A friend of mine who is an expert photographer often comes to me, when about to start on a hunting or fishing or photographing trip, and says:

"Shields, if you will tell me what kind of pictures you would like for RECREATION, I will make you a lot of them."

I tell him I want such pictures as sportsmen and naturalists like to see in their favorite magazine. Then this man makes his trip, comes home and reports that he did not find anything he thought I would care for, and so did not make any pictures for RECREATION.

The trouble is, he does not know how to select subjects. He travels with his eyes shut. He lacks the true artist's instinct. He does not seem to see the thousands of things which he passes and which, if photographed, would make interesting illustrations for this magazine. So it is with many other people. Fortunately, there are still others who do carry their eyes with them, as well as their cameras, and who send me the results of their photographic efforts. Thus I am enabled to present my readers each month with many interesting and valuable pictures.

I always dislike to publish my own work, either literary or photographic, in RECREATION; but in some instances it seems necessary to make exceptions to this rule. In my travels in British Columbia and Alberta, last summer, I found hundreds of subjects that it seemed to me would interest readers of RECREATION, so I made a great number of pictures, a few of which appear in connection with this article, and some of which may appear in future issues of RECREATION.

I could have made thousands of views of mountain scenery, but as a rule these are not what the general reader cares to see in a magazine. I was among the high peaks 3 months, and while I never tired of looking at them; while I never ceased to wonder at their grandeur; while every day and every change in the lights and shadows of the day or the night brought out new beauties in those giant sentinels, yet mere photographs of them would not inspire magazine readers as they do the traveler on the spot. A peak that towers 4,000 or 5,000 feet above your camp; that pierces the clouds, and from which glacial ice may be tumbling at all hours of



WHERE OLD EPHRAIM GOT HIS DINNER.



A DEAD SPRUCE AT TIMBER LINE.

the day and night, looks tame when pictured on a printed page. A lake that sparkles in the noonday light and glimmers in the rays of a full moon, or that reflects the myriads of stars in the milky way, or that pictures in its silent depths the mighty walls of granite, and glaciers, and snow slides, and rock slides; or a river that runs white over big boulders, and that

is guarded on either shore by giant firs, spruces or pines, loses much of its grandeur and much of its beauty when transferred to the sensitive film. Yet there are thousands of smaller objects, and even many large ones, that can be caught on a 5 x 7 plate, and that may interest and instruct millions of people when reproduced.

I labored under great difficulties last

summer. During the 90 days I was in the mountains there were 76 days on which it either rained or snowed, some part of the day. Frequently it rained all day, and there were only 4 days in the entire 3 months when the sun shone all day; yet there were many days when the sun would peep out for an hour at a time, between showers. There were gray days, when, though the clouds were thick, the light was even and steady. We had high winds a great deal of the time. There was fog hanging about us at least 60 of the 90 days; but by watching my opportunities, grabbing the camera and running whenever the

photographed, and written about, and lectured about for 50 years; so I need say little of them here.

Still, a big glacier is a great institution. It is a grand subject for the amateur photographer, and it is a good thing to have in the family, especially in summer. If I only had a few glaciers in New York I'd bust the ice trust wide open.

One day in July I climbed a high peak, at the foot of which flows the North Fork of the Saskatchewan. Near the summit of this peak there is a level spot of land, covered with moss and junipers. An old griz-



SOURCE OF THE MACKENZIE RIVER.

rain did cease, I was enabled to get many good pictures. I am no more energetic than other men; I simply watched for subjects and opportunities. I saw many things that had a picturesque, or a scientific interest, yet that many other men would pass over without really looking at or thinking of in connection with the camera. I flitted about more or less along timber line, that is, the belt around each high mountain where timber ceases to grow and where the bare, rocky walls begin to tower. There I found many strange things in the way of trees and shrubs which I photographed, and a few of which are shown on these pages. More of them may be shown in a future article. I explored several glaciers and made a number of views of them, more as souvenirs of the trip, and for my own album, than for any other purpose. Glaciers have been explored, and

zly had been there some months before me, probably in search of choice food, and had apparently discovered the den of a family of marmots. He had forthwith proceeded to dig them out and eat them. He certainly earned his dinner before he got it. He had made the largest and most remarkable excavation I have ever known a bear to make. I measured the hole carefully and photographed it, and the picture is shown herewith; yet it does not convey to the eye or to the mind of the reader a proper appreciation of the great task this old plantigrade performed. The hole is 5½ feet deep at the center, 10½ feet wide and 12 feet 8 inches long. The earth is almost as hard up there as concrete; but Old Ephraim had the courage of his convictions and a big appetite. He had, therefore, torn into the earth like a steam excavator. He had thrown out probably a



A STUDY IN CLOUDS.

carload of earth and rocks, some of the latter more than a foot in diameter, and some that would weigh 200 to 300 pounds each. While it is impossible to photograph a hole in the ground satisfactorily, yet I would not have been without my camera that day for \$100.

lose much of their grandeur in being reduced to the narrow limits of the photographic film; yet they are always interesting subjects for a fine lens.

Readers of RECREATION know that the world has frequently been startled by re-



A LAKE AMONG THE CLOUDS.

We were treated to some of the grandest exhibitions of cloud building I have ever seen anywhere, and I made a dozen pictures of the great banks of fog as they came up over the mountains. These, in common with the mountains themselves,

ports of the discovery, in various places in the West, of an ibex. We found one near one of our camps, among the high tops. That is, we found what many a man would have called an ibex, without making a thorough investigation. Here is a pic-

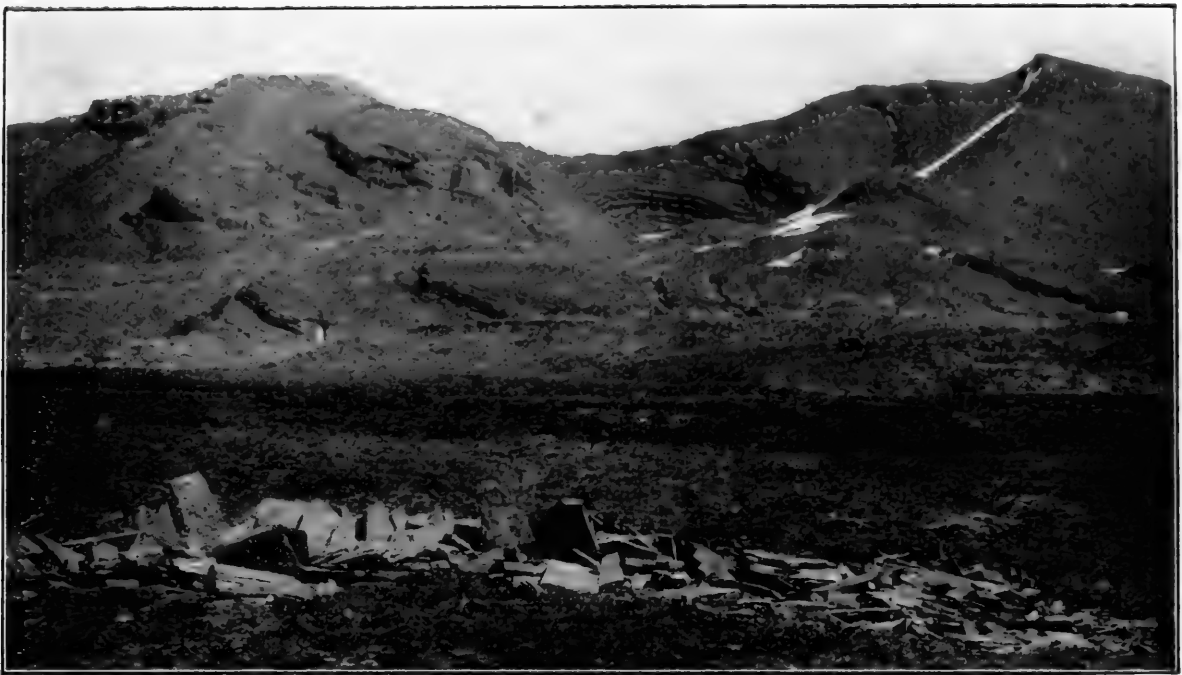

READY MADE TOMB STONES.

ture of him. However, on close examination he proved to be simply 2 sprouts that had grown up from the root of a fallen tree and died and shed their leaves. It happened that the root of the tree had been burned and a remaining bit of charcoal formed what appeared to be the animal's right eye. A piece of another sprout that had been broken off furnished a good imitation of an ear, and, viewed through the brush, the outfit looked very like a real ibex.

Many a so-called hunter would have plunked a bullet at such an apparition, and

it, or over it, or under it, and would still have told the other fellows how they hit it between the eyes. I know certain tenderfeet who would have fled from so formidable a looking beast, at sight, and rushed into camp wildly excited and told the boys between gasps, how they had seen an ibex, and that it dashed into the brush and escaped before they could get a shot at it.



THE ONLY AMERICAN IBEX.



IMAGINARY DEER HORNS.

then have gone to camp and told the boys how he had shot at an ibex, and hit it between the eyes, but that when he went up to it, it proved to be only a root of an old tree. There are other hunters who would have plunked a bullet 4 feet to one side of

This picture shows about as good a specimen of the real ibex as has probably ever been found on this continent; yet a well known British Columbia sportsman told me 2 months ago that he firmly believed there were plenty of ibexes in a certain remote



ALL SNUG AT SPRAY LAKE.

part of Alaska at that time. He said he had been assured of this fact by men who had seen them and whose word he could not doubt. I asked him how he accounted for the fact that though white men and Indians had hunted in Alaska a hundred years, not a single head or skin of an ibex had ever been brought out? He shook his head, but said he still thought there must be living specimens of this animal up there.

I saw on my travels several upturned roots that furnished excellent imitations of deer horns, elk horns, sheep horns or goat horns. We have all been fooled by such formations, and many of us have wasted cartridges on them. I photographed several of these imitation antlers, simply to show how easy it is for even an old hunter to be duped when he has his imagination with him.

At our farthest point North we camped

on a high summit on which one branch of the Mackenzie river rises. There is a meadow of several hundred acres, which has in it a number of springs and these combining form one branch of what is known as the Sun Capta river. This flows into the Athabasca; the Athabasca into Great Slave lake, and the outlet of that into the Mackenzie. So, strictly speaking the little brook flowing out of the meadow on the margin on which we camped, and which is shown in the picture, eventually finds its way through the Mackenzie into the Arctic ocean. The altitude of this meadow is 9,000 feet, and some of the peaks in the immediate vicinity rise 4,000 to 5,000 feet higher. One can step across the little brook, shown in the picture, but 2 miles farther down it, a horse would have hard work to step across it in half an hour. The Sun Capta is fed by glaciers at frequent intervals. Consequently, it

spreads rapidly over vast deposits of glacial mud and gravel, and is one of the most treacherous streams to ford that may be found anywhere in the great North.

Usually a picture of a camp contains little of general interest. It is only valuable to the people who shared in the luxury of it, who loitered within its shades, who satisfied their voracious appetites about its festal board. There are camps, however, which have something of general interest in them, and we made one such at Spray lake, 30 miles from Banff. Our tent was 10 feet wide and 20 feet long, with a 5 foot

practical purposes, as you would find in the Waldorf Hyphen Castoria hotel. We built good substantial bedsteads out of poles. I built an easy chair, which is shown in front of the tent, and over which I spread a piece of canvas that I carried along for the purpose. We built a frame for the tent, so as to dispense with the center poles at each end, and to make the tent so rigid and strong that it would resist the high winds. We had a stove in the tent, and when the cold rains came we closed the flap, built a fire and bade defiance to the other elements.



MORE TOMB STONES.

wall. We were to occupy this camp 10 days, so we proceeded at once to make it comfortable. Wright built a table that was a masterpiece of construction, in its line. He cut down a pine tree about 8 inches in diameter, cut off 2 sections of it, each about 6 feet in length, split them, and dressed each face with an adze and a jack plane. Then he flattened the round sides at the ends, so as to nail them on 2 cross pieces. To these he attached legs. Thus he had a smooth, level surface for the top, about 30 inches wide and 6 feet long. We spread a sheet of black oil cloth over it and had as good a table, for

I therefore thought it worth while to photograph this tent and to show a picture of it to the readers of RECREATION.

On a high plateau, at an altitude of 9,950 feet, I found some bunches of limestone that had been pushed up through the soil in a most peculiar fashion. Some of the slabs were a foot wide and 3 to 4 feet long, with perfectly even edges, carrying their width and their thickness throughout, as accurately as if they had been carved by a marble cutter. Others were 3 to 4 inches wide, 2 to 3 inches thick and over 3 feet long. What the motive power was that



THE REMAINS OF TWYFORD'S BONFIRE.

forced them up in this peculiar fashion on this level ground, and which cut or split them so evenly, no one knows, but they are there and here you see images of them.

We found on Wilcox's pass a dead and blackened spruce tree to which hangs a tale. You can not see it yet, but I will unfold it, so you may read it, thus:

In 1899, one Henry Twyford, an Englishman, camped within 100 feet of where this tree stands. He had visited that country for the purpose of hunting sheep. One day he went over the Divide, 4 or 5 miles from this point, found a bunch of sheep and killed 2 of them. He returned to camp feeling jubilant, and after dinner that night proceeded to celebrate by setting fire to the dead under branches of the fir tree. They were as dry as tinder and burned like a kerosene barrel. They created such a heat that the flames leaped up through the green branches and consumed the foliage as if it had been chaff.

As soon as the fire got fairly started, Mr. Twyford and his guide discovered, to their horror, that the wind blew directly from the tree toward camp. The air was filled with thousands of sparks, which descended on the camp like hail on a Dakota wheat-field. The dry grass and moss about the tree were at once ignited and the fire started toward the tents; slowly, as good luck had it, but surely. The nearest water was a little creek some 200 yards away, and the only vessels the party had to carry water in were 3 little pails which held about 2 quarts each. They grabbed these and lit out for the creek, hitting only the high places. In the darkness these got in the way of their feet, and each man tumbled end over end several times before reaching the creek. They took water and then walked slowly and carefully back to the conflagration. They sprinkled the water deftly and frugally about with their hands, checking the fire slightly, but the little pails were soon empty. Then each man had to make another dash for the creek. Meantime, though the fire was checked in one place, it spread in another, and time and again the beleaguered campers thought it was all off with them; that their outfit would be burned in spite of them and that the fire would destroy thousands of acres of adjacent forest besides. The laws of that country provided a fine of \$300 for



NATURAL PIPE WRENCHES.



A CONVENTION OF FREAKS.

starting a forest fire, intentionally or otherwise. The hard hearted, prosaic law makers had not even made an exception in case of a man who kills a sheep and wants to celebrate the event. Visions of fire wardens, sheriffs, policemen, judges and prison bars lent the wings of Mercury to the feet of the water carriers, wherever and whenever they could get a chance to run. The fight was kept up until 2 o'clock in the morning, when the fire was finally brought under control, before it reached the camp. Then an inventory was made of the damage. It was found that though the tent was still able to stand, there were over 200 holes in it and that blankets, pack covers and robes were more or less damaged by sparks; but the mighty Nimrod had saved his mutton and had celebrated the killing of his first and second mountain sheep.

I might cover 20 pages of RECREATION with descriptions and pictures of odd things I found in our travels; but I must stop and leave room for better stuff which my friends have sent me.

While in camp at Spray lake, we gathered up a lot of freak growths of timber, carried them to camp, set them up and photographed them. Two of these are almost exactly alike. Each one shows the result of a tree 4 or 5 inches in diameter, having fallen on a young spruce that was

probably an inch thick and bent it down to the ground. The sprout grew up, finally taking a half turn around the pole which lay across it, and forming almost an exact model of a plumber's pipe wrench. These 2 spruces are each about 8 inches in diameter and the stratification of the wood shows they are at least 40 years old. The saplings must therefore have fallen across them 40 years ago and both are still in a good state of preservation.

The creek that flows from the great Bow glacier into Bow lake, has cut a narrow chasm through a solid wall of limestone, nearly 50 feet deep, and yet so narrow that one can step across it at the top. I climbed down to the level of the creek at one point and got a picture looking up through it. I focussed at 30 feet and by stopping the lens down to 128 f. was able to get good detail in both foreground and background. The small spruce shrub on top of the rock, shown in the center of the picture, was at least 60 feet away, yet is perfectly sharp. An interesting feature of the photograph is the exquisite lighting. The picture was made when the sun was directly overhead, and the rays strike projecting points on the rock here and there, all through the chasm, thus showing the weird, rugged formation of the walls.

I trust I have shown pictures enough here to give many of my readers valuable

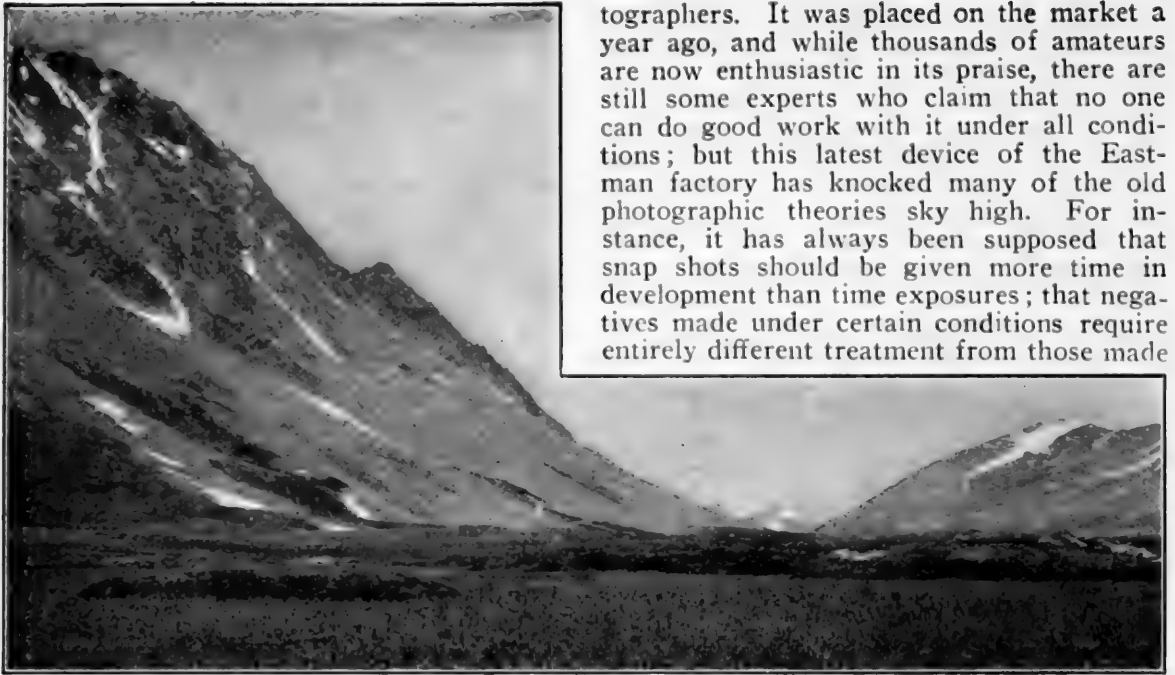

STRANGE MOUNDS ON THE CONTINENTAL DIVIDE.

hints as to what they may find if they go into the woods or the mountains or even on the prairies, carry their cameras with them and if they travel with their eyes open. You may not find exactly the same kind of things, but you may find a lot better things for pictures. You need not go to wild, inaccessible places to find novelties or objects of artistic or scientific interest. I never walk a mile in Jersey or in New York or in Pennsylvania, or in any other State, without wishing I had my camera along, or without using it, if I have it.

Many of you have no doubt been wondering what camera and what lens I use. It is only fair to the makers of these instruments which did me such good service that their names should be made known to you. These names are household words throughout the civilized world. I use a 5 x 7 Eastman Cartridge Kodak and Eastman films. This box is fitted with a Goerz double anastigmat lens and a Goerz shutter. The machine was mounted on a Goerz aluminum tripod, which weighs only 2 pounds.

I also carried with me an Eastman developing machine, and this proved one of the greatest luxuries that modern ingenuity has provided for the use of amateur pho-

tographers. It was placed on the market a year ago, and while thousands of amateurs are now enthusiastic in its praise, there are still some experts who claim that no one can do good work with it under all conditions; but this latest device of the Eastman factory has knocked many of the old photographic theories sky high. For instance, it has always been supposed that snap shots should be given more time in development than time exposures; that negatives made under certain conditions require entirely different treatment from those made

under other conditions. Theoretically, this may be true enough, but I developed several rolls of films that had on them some exposures made with the lens wide open and the shutter working at 1-100th of a second; others with the lens stopped down to 128 and in exposures timed at 10 to 20 seconds each. Such rolls, placed in the developing machine and ground out with careful attention to printed instructions, brought out all the negatives with equal fidelity to nature. Most of the pictures reproduced in this article are the result of time exposures, with the smallest stop; yet some of the others are from snap shots. The proof of the pudding is in eating it, and I frankly admit I could not have got better results on any of my plates if I had cut the films and developed each one separately and in accordance with old time methods.

I have been making pictures more or less for 26 years, and have used a number of different cameras and lenses; and while I am aware that many of my readers will disagree with me, I regard this as about the best outfit, all things considered, that can be made up for a photographic trip in a wild country.

He: I believe you think more of that dog than you do of me.

She: But he's worth so much more.—
Exchange.

THE TRUE STORY OF THE NEZ PERCE WAR.

H. B. NORTON.

I find nothing to criticize in Major Brooke's interesting article, "A Ride Through the Land of the Nez Perces," save his assertion that Uncle Sam paid a round sum to recoup the losses sustained by settlers during the Nez Perce war. Myself a loser by that uprising, I know that not a cent has been paid for property destroyed by Joseph and his band.

In the early days of what was then known as Camas prairie, the settlers for miles around were accustomed to gather each 4th of July at Mt. Idaho and celebrate the day. On such occasions the Indians were always invited to take part.

At the time of the outbreak Chief Joseph had planned to assemble all his warriors at Mt. Idaho July 4th and massacre the entire white population of the prairie; but on the afternoon of June 13 3 young bucks, Mox Mox, Walltits, and another who is unknown, killed the first victim, an old man named Richard Devine. He was killed at his ranch, 8 miles above Slate creek. That night the same Indians went down the river to John Day's creek, and early the following morning killed Henry Elfres and Henry Beckrode. Then, mounting horses belonging to the murdered men, they rode on down the river. On their way they met Samuel Benedict, who was out looking for cattle. They wounded him, but he managed to escape.

The Indians then left the river and went to Camas prairie. Returning the same day with 15 or 20 more Indians, they shot and wounded J. J. Manuel and his little girl, and killed James Barker. At Benedict's place they murdered Benedict and a Frenchman named August Bacon.

On June 14 they killed Mrs. Manuel, whose body was never found; also Wm. Osborne and Harry Mason. It is claimed Joseph took part in these murders.

The same day J. M. Crooks, of Grangeville, rode to Joseph's camp to ascertain whether the Indians intended to carry on war against the settlers. He was told the settlers would be let alone, providing they would not help the soldiers.

By that time the whole country was aroused, and settlers came pouring into Mt. Idaho from all directions.

Chief Joseph's band, including his brother Ollicutt, were camped at the head of Rocky canyon when the massacre took place, but, fearing the approach of troops, they went over the White Bird mountains

and set up their lodges in White Bird valley, a short distance from Salmon river. There they were joined by Chief White Bird and his band.

At sunrise on the morning of June 17th, a weary company of 90 soldiers under Colonel Perry, together with 10 or 15 volunteers, reached the top of White Bird canyon, about 16 miles away. Indians and soldiers discovered each other about the same time. The Indian encampment was instantly aroused. Joseph, Ollicutt, and White Bird placed their warriors in position. As the soldiers moved down the canyon they met Mrs. Benedict, a baby in her arms, and a little girl by her side. She had fled from her home after the murder of her husband, and was trying to reach a settlement 20 miles away.

The soldiers continued their march down the canyon until they came to 2 small buttes. The Indians camped beyond these buttes were thought to be only a portion of those on the warpath, it being reported that the main body had crossed to Salmon river. As the troops approached the buttes Lieutenant Theller, with 8 men, was 100 yards in advance of the main force. Colonel Perry, with the volunteers and his own company, came next. Thrimble with his squad brought up the rear, leaving an interval of about 50 yards between each company. All were in columns of fours.

Suddenly the Indians popped their heads from behind rocks in the gulches and ravines, and took deliberate and deadly aim. Chief Joseph instructed White Bird to turn the cavalry at the upper buttes, while he went behind the rocks and lay in wait for them. Mox Mox was directed to take the women, children, and horses down White Bird creek and to be ready to send horses to the warriors as fast as those they had were shot down. All instructions were carried out to the letter. The battle had not been in progress 10 minutes before the cavalry was thrown into confusion. Their horses became unmanageable, and all hope of defeating the Indians was abandoned. There was nothing to do but retreat, striving to reach the canyon from which they had come. Some were headed off by the Indians and fell, bravely fighting. Others escaped out of the canyon of death to the top of the mountain, where about 20 men were rallied by Colonel Perry and Parnell. The Indians pursued the retreating cavalry within sight of Grangeville. Lieutenant Theller was left dead on the field, and of

100 men who went into the battle not more than 60 returned. It was never known how many Indians were killed, but the number must have been comparatively small.

The settlers and soldiers, then cooped up at Mt. Idaho and Grangeville, anxiously awaited reinforcements. But Joseph, instead of attacking them, remained several days encamped at White Bird. This delay on his part gave time for troops to reach the seat of war.

Volunteers from Walla Walla, Dayton, Waitsburg, and Lewiston flocked to the rescue of the settlers. On the 24th they arrived at Morton's ranch on Camas prairie, 20 miles from Cottonwood, where there is now a prosperous town. Perry came there during the day and notified General Howard of the position of the Indians. They were still at White Bird canyon. Howard advanced with his forces to recover and bury the bodies of those killed in the battle. That accomplished he located Joseph across Salmon river, 5 or 6 miles distant from the battlefield. At that time Chief Looking Glass and his band were supposed to be some 30 miles in Howard's rear.

Colonel Whipple was ordered to arrest Looking Glass and his Indians and turn them over for safe keeping to the volunteers at Mt. Idaho. Looking Glass was given an opportunity to surrender, which at first he promised to do, but afterward defiantly refused. The result was that several Indians were killed, but Looking Glass and his band escaped. Whipple then rejoined Colonel Perry.

On July 2d Scouts Foster and Blewett went in the direction of Craig's mountain to reconnoiter. Toward evening Foster returned and reported the Indians at Sawyer's canyon, about 12 miles distant. Whipple sent Lieutenant S. M. Rains with 10 men to ascertain the strength of the enemy. Rains and his men were cut off and killed only 2 miles from the headquarters of the troops. It was afterwards learned that Blewett was thrown from his horse and killed by the Indians.

On the morning of July 4th Perry's detachment joined Whipple at Cottonwood. About noon of that day 17 men were crossing the prairie to Cottonwood. Within 1½ miles of the encampment and in

plain view of the troops, they were surrounded by about 125 Indians. Though the fight lasted more than an hour, only one man went to the assistance of the sorely beset little band. Major George Sherer, a volunteer, watched the fight a few minutes. Then saying, "A man may be a damn fool if he goes down there, but he's sure a damn coward if he doesn't," he mounted his horse and joined the 17. Afterward Colonel Whipple went down with about 24 men.

Perry claimed, before a court of inquiry held at Lewiston, that there was a force of Indians in his rear, and he could not afford to lose his stronghold on the hill.

In that fight Captain Randall, Ben Evans and D. H. Hauser were killed; Johnson and Allie Leeland wounded. The 17 men were all settlers, defending their homes and families, and after the war was over many had not a home to go to.

From that time until July 11th, skirmishes took place here and there. On the latter day the Indians concentrated at the mouth of Cottonwood creek. There the final and decisive battle was fought, lasting 2 days. The Indians were defeated and driven out of Idaho into Montana.

I will not attempt to describe their flight nor the destruction they wrought before their capture at Bear Paw mountain, 1300 miles from their starting point.

Since then Joseph has been fêted in various parts of the country and held up to admiration as a great and good Indian. If his admirers had shared the troubles of the Camas prairie settlers they would have longed to hold him up with a rope.

White Bird met his just deserts in the Assineboine country a few years ago. He was a medicine man, and, undertaking the cure of a sick Indian, who finally died, was killed by the sorrowing relatives on the ground that he had bewitched his patient.

Senator Mitchell introduced a bill providing that each volunteer who joined the forces of the United States in Oregon, Washington, or Idaho, during the Nez Perce war should be paid \$1 for each day of service; also the actual value of any horse, arms, etc., lost by him in such service. The pension laws were made applicable to those who contracted wounds or disease during the war; but I have never heard of anyone's recovering a cent.

Clara—I knew by the tone of his voice that he was going to propose to me.

Maud—Was there a ring in it?—*Detroit Free Press.*



AMATEUR PHOTO BY MRS. WM. B. LEE.

ON A NEWFOUNDLAND MARSH.

Winner of Special Prize in RECREATION'S 8th Annual Photo Competition. Made with No. 4 Eastman Cartridge Kodak.

See page 168.

FISHING.

EMMA G. CURTIS.

A-restin' on a grassy bank,
 Encumbered with a fishin' pole,
 To-day I watched the muskrats prank
 And swallers skim the minner hole;
 I mused amongst the dragon flies,
 And young birds practisin' their wings,
 And lily pads and pictered skies,
 How fishin's like most other things!

The chap that digs the fattest bait
 And picks the likeliest day and pool,
 That don't poke round and start too late,
 That hustles sharp and yet keeps cool;
 And when he's got things workin' right
 Jest settles, calm as heart can wish,
 And gives 'em time to bite,
 That man will get a string of fish.

But that there sort that tears around,
 That first tries this pool and then that,
 As nervous as a rabbit hound,
 And on the fence 'twixt perch and cat;
 That thinks that spittin' on his bait
 Makes up for bait that's tough and pore,
 That never gets it through his pate
 That big is big, not luck and roar;
 That keeps a-jerkin' up his hook
 And keeps his line a-goin' swish,
 Before his catch is fairly took,
 He'll go home mighty short o' fish.

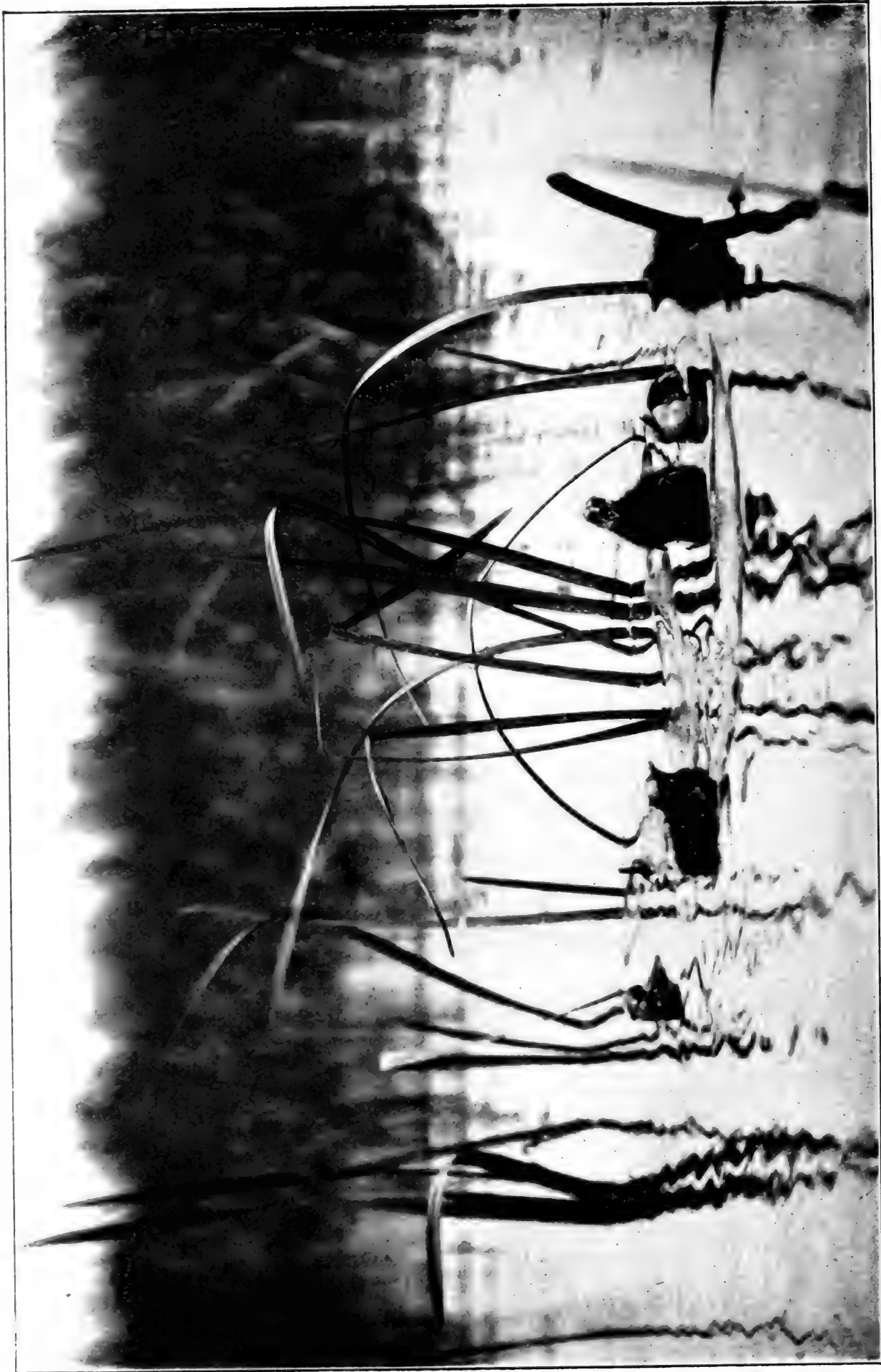

AMATEUR PHOTO BY J. E. STANLEY.

AT HOME IN THE RUSHES.
PIED BILL GREBE.
Winner of 2d Prize in RECREATION'S 8th Annual Photo Competition.

A PIONEER'S ADVENTURE.

A. A. BRIGGS.

In the early 70's the forests of the Muskoka district abounded in game, including deer, bears, wolves, black and silver foxes, etc. Game laws were almost unknown, and the gun of the early settler was in constant use. Our homestead was in the Parry sound district, and was surrounded by wild roses and creeping vines. At the foot of one of the many hills ran a trout stream, whose limpid, shaded waters attracted the wild animals and birds.

While fishing for trout in this stream I saw a big deer running up the side of the hill. Behind it was a dog, howling and fast losing ground. As the dog approached the top of the hill he gave out. The buck was the largest I had ever seen, and I was naturally anxious to get a shot at him. As he had been disturbed while drinking at the brook, I thought he would not return for some time. Accordingly, I wound up the line, went home and ate my supper.

The next morning I saw what appeared to be cattle in the vicinity of the stream, but soon discovered they were deer. I reached for my rifle and pushed up the window, thinking I could get a shot, but the deer heard me, and in a moment they were off. Still I was sure the buck that dashed up the hill the day before was among them. Wild with excitement, I ran to the creek. There I tried to think of some ruse to entrap the buck. An idea occurred to me, and going to the house I hunted up the largest straw hat in the place, and, putting it on, returned to the stream. I followed a covey of grouse for a while, more to pass away time than to kill, as it would be an hour or so before the buck returned.

Looking about for a hiding place, I saw some tall, thick grass among a lot of bushes, and there I concealed myself. Making sure my body and limbs were invisible, I pulled down the big hat and, with the rifle under my arm, waited for the stag. Nearly an hour passed before I heard a sound. Presently the buck appeared, and a grand and stately creature he was. I must have been greatly unnerved, for my arm was shaking so much I feared the animal would see the movement in the grass and dart off. My view of him, too, was unsatisfactory, for I had to blink with one eye through a little hole I had made in the hat. What I saw was sufficient to show that he suspected danger, for he kept bellowing and tossing his head around as if infuriated.

While I was watching him 3 more heads came in sight a little distance behind the buck. These were the doe and 2 fawns, who, seeing the stag gazing around anxiously, were too timid to come nearer. Suddenly I saw the antlers of the buck moving in my direction and thought my end was near. My fingers, which instinctively sought the trigger, twitched nervously, though the idea of shooting never occurred to me. The buck sniffed around 3 or 4 seconds, with his eyes fixed on the hat, then began slowly to retreat. Now, if ever, was the time to shoot; his head was raised and his breast toward me. But, no. I would wait and see what the stag would do. Presently he uttered a low, dismal sound and in an instant the other deer were beside him. At first they looked around perplexedly, but soon moved toward the brook and drank. The old buck never stirred. He was now within a few yards of me, still keeping his eyes in my direction.

At length the deer, having finished drinking, went away. The buck, seeing this, retraced his steps to the edge of the stream, and for the first time took his eyes off the place where I was hidden. Seeing the doe and fawns were over the fence, he lowered his head, gulped a mouthful of water, was up in a second and off, leaping the old rail fence with the greatest ease.

I lay for a moment wondering if I was dreaming, but the drumming of a grouse near me and the rippling of the brook soon dispelled the idea. Alas! had any of the settlers seen me? If so, my reputation as a marksman was ruined. I had been acknowledged the best shot for miles around, but if the story was told that I, with a rifle in my hand, allowed 4 deer to escape within a few yards of me I would be the laughing stock of the settlement.

I left the stream with a strange feeling. My desire to hunt had vanished. When I told my experience at home they were rather touched by the incident. But to this day the people of the district never heard that the man who for years had never refused a shot at game had allowed sentiment to stay his hand on one occasion.

To-day the scene is changed. The old log house has fallen to decay; civilization has driven the game Northward. Only the old pines still cast their shadows on the rippling brook, which flows on as ever.



AMATEUR PHOTO BY S. L. BEEGLE

BOB WHITE BY FLASHLIGHT.

Winner of 3d Prize in RECREATION'S 8th Annual Photo Competition. Made with Goerz Lens.
See page 168.

THE ENCHANTRESS.

GEO. E. WINKLER.

A longing once again to view
The distant, blue limned hills,
To drink again with thirsty lips
At ice-fed mountain rills:
To wander echoing canyons through,
Took me from you.

A longing once again to see
The early sun rays strike
Like fire upon the lifted crest
Of snowy mountain height;
To stroke with lazy, loving oar
The quiet waters, deep and blue,
Took me from you.

But each elusive cloud suggests
Your changefulness and grace,
And ev'ry dew-kissed rose commends
The sweetness of your face;
The whisp'ring pines that roof my head
Bid me their lovely joys eschew,
And turn to you.

"Have you ever listened to that long
Island sound?"
"No, but I have heard New York bay."—
Life.

DOWN THE ARBUCKLE RIVER.

F. W. PORTER.

We loaded my hunting boat on a wagon at my ranch one morning late in January, and drove 5 miles to Rocky creek, where we launched.

I told the boys we shouldn't see any game on the way over, but they thought quails, squirrels and rabbits were game, so we had camp meat at once. From Reedy lake to Arbuckle lake is 4 miles if you are bird-rigged, and climb a tree to start. By water, it is nearer 40 miles. We floated half way down the creek that afternoon, and camped where I had a turkey roost spotted. I made camp and sent the others where I thought the big birds would come in. They returned at dusk without any turkeys. Some had been seen, but Winchester said they looked just like those his mother had at home and he didn't like to shoot. My other friend I'll call Thunder, because he used a double 10 gauge loaded with black powder.

Next morning we continued our journey down the creek. The lower end of the creek is through a heavy swamp which was dry a year ago for the first time, possibly, in centuries. Then fire swept it, throwing trees and vines of all sizes across the creek, so there was some fancy acrobatic work. Sometimes we would vault over a log which the boat went under, sometimes we would go under and lift the boat over, sometimes a dive through a tree top was the caper. Once, when we flattened out in the boat to squeeze under a big cypress, one chap left the slack of his trousers a trifle too high. The craft drifted placidly on and left him hanging, head to heels, from a branch. We rescued him before the cloth tore, and got to the mouth of the creek by dinner time.

The creek had built itself a bank far into the lake and our camp was on a part of that, 20 yards wide, the creek on one side and lake on the other. We spent the afternoon there; the boys fished and discovered a 10 foot 'gator.

Arbuckle lake is 8 miles long and 3 miles wide. It is usually wind-swept during the day, and, as our boat was small and overloaded, we decided to cross at night. I woke about midnight, found it foggy but not dark, and perfectly quiet. I roused the camp and after we had made coffee we put to sea. A 2 hours' row took us to the lower end of the lake and to what appeared a solid wall of cypress. The steersman was told to coast along it until he saw an opening. He did so and in a few minutes put us in the head of Arbuckle river.

We ran alongside a bunch of bonnet and dropped anchor to wait for daylight. Thun-

der wanted to try for catfish. We were willing he should but had no bait. We got over the difficulty by shooting a water turkey and using strips of its flesh. Our friend got lots of strikes, some of them strong enough to move the boat, anchor and all, but as he was not used to the fighting tactics of Florida catfish he did not land a fin.

When daylight appeared we started down stream through one of the prettiest bits of water in Florida. The river averages 100 feet in width, is deep, and for several miles runs through a big cypress swamp.

A dozen species of lilies grow on its borders, and the trees are covered with air plants and orchids. The swamp is inhabited by many varieties of game birds and animals.

The dip of ducks and the whir of wings was constantly heard ahead of us, but as the foliage was dense and the stream tortuous, we got but few shots.

A short run took us through the swamp and out into open water with Kissimee prairie on one side and high pine woods on the other. There, in a little hummock of cabbage palms and live oaks that gave us almost the shelter of a house and furnished us beds of Spanish moss, we made our permanent camp. We caught bass with minnows, and would not take out of water a fish under 8 pounds. We drifted down stream gawking at one bank while a gobbler sat and gawked at us from the other. He gawked a little too long for his health, however.

Winchester shot into a bunch of curlew, and as he waded about picking up his dead, a flock of canvasbacks almost knocked his hat off. We, in the boat, wondered why he did not shoot. He came back and said they were not ducks. On one occasion, as curlew and other birds were passing over us by thousands, somebody sat, eyes and mouth open in astonishment, until his gun went off, pointed nowhere in particular, and nearly knocked him out of the boat.

Then came the last morning, which we had decided to devote to turkeys exclusively. Two of us got up and had our breakfast, of course, long before daylight, and we had almost to drag No. 3 out of the blankets. Finally he came along and we got our turkeys, one of them a 25-pounder that Winchester knocked into the river. He was surprised to see it go paddling up stream, and said if any one had told him a turkey could swim, he would, if it was a small man, have called him a liar.



AMATEUR PHOTO BY CHARLES VANDERVELDE.

THE FISHERMAN WHO IS ALWAYS LUCKY.

Winner of 4th Prize in RECREATION'S 8th Annual Photo Competition. Made with a Korona Camera.

ANTOINE'S CAT.

E. W. PARKER.

Lass week bring me some sperience Ah'll never have before, an' me Ah'll tol' heem to heverybody so he can look out not make same mistak'.

Ah'll not spick de Angleesh ver' wal, but Ah'm cut mah eye teet hevery day, an' w'en he com' night Ah' say to me, "Well, ole man! eef you ole fool head don't know better dan go poke you nose on de cat bees'-ness, den he serve you right for bring de trub on you. So nex' tam look out, ole man."

Now, Ah'll tol' one leetle scrape dat overtak' me. S'pose you want try you' han' for dat same speculation affer you hear dat, Ah'll offer no objecshun at all; an' if you not lak dat, you may shun mah leetle mishap an' not be ole fool lak Antoine.

Two, t'ree week ago mah wife hax me will Ah go wit he an' mak' hevening visit to Zephrim Goshela. "Oui, Oui, Madame! Ah'll go." Now Ah'm not lak ver' wal for gon out on de evenin'. Me Ah caint see ver' wal, an' dis tam de moon he's not 'wake up ver' herly. But Ah'll lak please mah ole leddy sometam, so Ah go. Zeph- rrim an' hees wife was bote good feller an' we been good neighbor many year, an' Ah lak heem wal. 'Sides dat, he's raise beeg famlee an' many tam he com' for mah ole leddy for assist dat, an' for me, too, some tam. So we feex up an' finish mah chore, an' 'way we gone.

Now he's got 'bout quarter mile over dar, 'cross de fiel'; hover 2, t'ree fence, jump on de brook an' go up on de hill, dar's whar he leeve, and when we geet dar, we was ver' welcome. Zeph and me too we sit down an' tak' some smoke, an' Mam Zephrim an' mah wife tak' hees knit an' mak' stockin'. What tam we smoke we lay good many plan for gon on Black crick for catch muskrat, an' dore, plentee monee on dat job. We 'gree for gon on dat plass nex' week, an' we 'gree for share de hex- pense an' go snuk on de profheet.

An' we can carry plentee pork and pom- me de terre an' bean, too. An' me Ah'll tak' mah fusee, Ah got boss good one. We'll get plentee pa'tridge and cariboo for tickle our stomick an' we can see no hobstruction for hav' boss tam ever' day we gon', bah gosh!

Bimeby Mam Zephrim get up an' gon' out on de kitchen, an' soon Ah hear heem mak' rattle on de stove, an' Ah know he's gon' for get supper. Mah ole leddy ron after an' beg heem not do dat for we not hongry at all. But Ah'm pull hees dress and whisper, "Hole you' tong." Pretty

quick Ah'm smell de pork on de pan an' de onion, too, an de tea kettle lid jingle an' we be all jus' so happy good many beeg bug who try for call heemsef de aristoc- racee.

Nex' Ah know, de clock strike one, 2, t'ree, 'leven! Mah soul! whar is gon' dat hevenin'? An, mah ole leddy rose for go home an' roll up hees knitting on hees pocket, an' make all reddy.

Many year ago w'en Ah'm small boy, ver' of'en Ah'm gon' cross de same fields for huskin' an' pare apple bee. Ah'm go befor' he's dark an' Ah'm feel bol' lak a lion. But de tam w'en he's finish an' it come 'leven 'clock an' dark lak a dev', Ah'm com' bol' lak a sheep; 'twas a differ- ance, don't it? Good many noise dar. One leetle frog can mak' me ron more 10 rod. One screech owl flop down close on top mah hed mak' me squat down lak brickbat hit me. Dat tam Ah'm all 'lone. Dis tam mah ole leddy is wit me an' not'ing can't scare me. So w'en mah wife rose for gon' home an' Ah'm light mah pipe an' shak' han' an' 'way we go, over de hill to de poor house—dat was Antoine's.

Now Ah'm meditate good 'eal 'bout de Black crick bus'ness, an' fuss Ah know Ah'm leave mah ole leddy long way behind an' soon Ah'm hear heem yell, "Antoine, what for you so hurry? You got no bus'- ness leeve me 'lone, an' Ah'm hear som- t'ing chase me."

So Ah'm gon' back to he, an' Ah ax heem what he hear? He's tell me som- t'ing skip it 'long behind heem on de snow an' mak' queer leetle noise lak he never see befor'; and w'en we go long 'gain we bote hear dat, an' bahgosh! Ah can see dat too 'bout 10 feet behin'. Now Ah'm tell heem walk ver' slow an' me Ah'll feex dat. So Ah tak' a pole on de fence and go ver' heasy.

Dat leetle chap, Ah see heem sure, he's black, not ver' beeg, prob'ly weasel. 'Tenny rate Ah'll not 'low heem scar mah ole leddy any more. No, seh, he's draw hees las' bret. So Ah raise mah pole high over dat an' put in all mah strengt on heem an' down he com', whack! on hees back 4, 5 tam. Mah wife he's ron an' mak' yell, but dat leetle feller's not ron any mo'. Hees turn up on hees back an' lay still. Den we proceed to examine dat and Ah'm cal'late hom much hees pelt will fetch on de mar- ket. So Ah'm light a match an' look; an' bahgosh, what you t'ink? 'Twas not'ing but mah ole leddy's knittin' work. De ball unwind in hees pocket an' drag de rest be-

hind on de snow. Ah'm get de laugh on heem long tam for dat.

But dat was not de lass mah sperience 'fore Ah'm get home; oh dear, no! Som' ver' queer episode happen 'fore Ah'm reach mah domicil. Ah'm mak' hurry for get home an' feex mah fire, an' so Ah'm leeve mah ole leddy for come on by heemse'f.

Jost dat tam Ah'm hear som'ting step, step, on de snow.

Ah'm not scare 't all, an' w'at you t'ink dis tam? Dar was one pretty leetle kitty com' rat up close an' look hon mah face lak he want make 'quaint wit Antoine. When Ah see dat Ah'm glad, for we got none, an' lass week mah old leddy he's find a mouse in de flour barrel.

Now here he com' mah chance for one boss leetle cat, no cos' not'ing only for catch heem. Dat leetle chap he come frisk roun' mah leg lak he want play wit me. So Ah'm put 'way mah pipe an' Ah'm go in for dat kitten an' he will mak' mah ole leddy nice Chris'mus present.

"Now, mah leetle kitty, com' to me; com,

see you Onc'. Com' on mah house, it's boss plass for leev." An' Ah squat down an' coax heem an', bahgosh, he won't. He's kick up hees heel an' caper roun' me, an' more Ah'll see dat de more Ah'm 'termin' for tak' heem. So Ah'm ron for heem an' he hop roun' on de snow an' swish hees tail, an' Ah'm mak' up mah min' Ah'm got one Anglory cat wort' more'n 5 dollor.

Nex' Ah know, he scoot rat in between my mogasin an' Ah'm mak' grab wit bote bote han'. Nex' minit Ah'm gon' rat hover on mah back. Oh, waugh, phew, ugh, waugh! Ah'm sick on mah stomick an' Ah'm have ter'b'le time.

Ah'm put som' snow in mah mouth, he don do no good. Den Ah'm dig hopen mah eye an' look for mah ole leddy, and he's gon' home. An' Ah'm look for dat cat an' he's gon' home; an' Ah'm hole mah nose an' Ah'm gon' home, an' w'en Ah get dar mah ole whoman he's put de bar on de door an' he's holler on de chamber window, "Antoine! go sleep it on de barn!"



AMATEUR PHOTO BY JAMES H. MILLER.

WHERE'S MY SHADOW?

One of the 17th prize winners in RECREATION'S 7th Annual Photo Competition.

TAKE US AFAR.

JEANNETTE CAMPBELL.

Take us afar; beyond the city's clamor,
Its din and dust and glare;
Its grinding toil, its gilded pomp and power,
Its stifling, fevered air!
Afar; beyond the ceaseless tide of faces
The endless throb of feet;
The eager grasp for gold that men call
living,
The jargon of the street.

Afar, afar, beside the dreaming waters,
Deep in the forest glade,
Where wind and wave commune, low-
voiced, together,
In sunshine and in shade!
Where just to be, is gladness; where life's
trappings
Drop off and disappear;
And we can drink at Nature's primal foun-
tains
Once in the rushing year!

"I want to ask you something, gracie,"
said the beautiful heiress.

"What is it, duckie?" the duke inquired.
"Would you object if I should request
the minister to omit the word 'obey' from
the service when we are married?"

"Certainly not. He can just make it
'love, honor and supply.'"—*Chicago Rec-
ord-Herald.*

A PIONEER REMINISCENCE.

MISS M. L. SUTTON.

In the mountains of Jackson county, Oregon, lives an old man familiarly known through all the region as Uncle Bill. An excellent story teller, he speaks with such familiarity of Indians, panthers and bears that small boys of the present are jaundiced with envy.

His favorite tale is of the capture of the largest grizzly ever encountered in that section; and well illustrates the fortitude that made our pioneers the bulwark of the West.

Near Uncle Bill's home, is a rugged foothill, thickly wooded with scrub oak and crowned by an immense boulder known as Table rock. That hill once served as staging for a little comedy, which came near being a tragedy in Bill's life.

Armed only with a light shot gun, he was one day wandering about the mountain in search of lost shoats. Entering a small natural clearing, he came face to face with a huge grizzly feasting on wild berries. Both were surprised; but Uncle Bill was chiefly concerned. Without his rifle he felt his presence was an intrusion. There were no trees within 80 rods; and he saw with dismay that the grizzly seemed desirous of making his acquaintance.

Taking counsel of his courage, Uncle Bill mounted a log in the middle of the clearing, and tried to stare the bear out of countenance. Satisfied from a close scrutiny, that Uncle Bill was in a palatable condition, Bruin began circling about his intended victim. He tore up the earth, growled fiercely and made frequent little dashes, as if to provoke Uncle Bill to flight. Failing in this, the circles gradually narrowed in, until Uncle Bill drew his hunting knife and braced for the shock, determined to sell life dearly.

Suddenly the brute stopped, sniffed the air, and gazed intently down the mountain. A bristly crest arose along his enormous back; he seemed to waver between 2 opinions. Then with a roar of baffled rage he turned tail and lumbered up to the shelter of the overhanging rocks. Uncle Bill chose an opposite direction with even

greater celerity and soon encountered 2 neighbors out for a hunt, which they promptly abandoned in that vicinity after hearing his story.

Some weeks later, a dozen men with a pack of bear dogs gathered to hunt Bruin out. He must have had a premonition of danger which he decided to anticipate by a prompt retreat to his winter quarters, several miles up Bear creek. The hunt followed. The men took stations in trees at intervals of about 60 rods along the trail, and the dogs were sent in to start the game. The occasional sharp yelping as they skirted the lair soon changed to a chorus of excited baying and warned all to be in readiness.

With a rush, to which the undergrowth was no impediment, the bear passed directly underneath the first sentinel, receiving a rifle ball between his shoulders, with no apparent result. His course was direct for the next stand, but all waited in vain for the report to tell that he had reached it. The baying dogs rushed by and became silent. The stillness grew oppressive. Calling to one another, all the hunters, save one, responded, and the posse cautiously gathered about his position, to find the bear's dead body overlying a battered rifle and bits of bloody clothing.

Their companion was nowhere to be seen, but a weak voice from a near manzanita thicket was heard saying, "The bear's dead, boys, and I am too;" which, in spite of the seeming inconsistency, came near the truth.

The bullet from the first stand had pierced the bear's heart, but the animal's great momentum and vitality had enabled it to reach the next sentinel, drag him from his tree, literally scalp him and toss him aside, before it fell dead.

An army surgeon from the barracks, 25 miles distant, saved the unfortunate hunter's life, but left him disfigured by a stiffened neck and a head permanently turned to one side.

The bear's carcass dressed 800 pounds net; and its fine pelt passed as a fee to the surgeon.

Clara: I hope you don't call yourself an invalid, with that appetite!

Clarence: Why, Clara, it is this appetite that keeps me an invalid.—Exchange.



THE GOLF GIRL.

AMATEUR PHOTO BY GEORGE WORTH

Winner of 5th Prize in RECREATION'S 8th Annual Photo Competition.

BUFFALO HUNTING IN KANSAS.

STUBB.

We had sown our fall wheat and having nothing further to do at home, Charles S., Bill K. and I started for meat. We traveled West about 100 miles and saw only old signs. I carried a 38 rim fire Remington, Bill a 44 rim fire, and Charles a 44 rim fire Ballard carbine.

After getting above running water on the Pawnee river we turned South and crossed the Arkansas. In due time we arrived at Dodge City, a bad town at that time. There we saw hundreds of buffalo hides, all of which came from the South, so South we went. After traveling one day we reached Crooked creek, and there close to our camp, some one had killed 3 buffalo a day or so before. One day's hunt revealed no game, however, but antelope and those were not tame, so we got none of them. That evening we held a council. Bill and Charley decided to go home, but I had made up my mind to see a live buffalo. Next morning I went back with the boys to Dodge City for more provisions, and then started South.

I spent the night at our old camping ground, and the next evening about sunset a party of Texans drove up. They said they had seen no buffalo for 3 weeks. They invited me to go with them as they wanted to go into Texas and some of the Reds were out from their reservation on a hunt.

Early the next morning we were on our way. The day passed without incident and that night we camped at Lone Tree, a good camping ground on account of water, but more interesting to me on account of its being the scene of a disastrous fight between 5 white men and a band of Reds only 3 or 4 months before. The graves of the 5 white men told the tale without words.

The next morning just after starting I saw my first live wild buffalo, a cow and a calf. I wanted to kill them and go home, but the boys persuaded me to go farther and get a good load. We arrived at their camp that evening, and the next morning, which was Christmas, we started Southwest. Before noon one of the men, who was in advance of the teams, killed a large buck. We took it aboard, also the hunter, and proceeded some distance when I saw another buck, standing in some small brush and looking at us. As I had no driver, I spoke to the man who had killed the first buck and pointed out the second. He started, but had not gone 200 yards when in going over a small ridge he ran almost on to a large buffalo, asleep. John soon woke him with his 50 caliber Sharps

frontier gun. The buffalo arose and ran but seemed dazed. The 50's were going through him too fast for any kind of comfort. Finally, getting tired of it, he turned on his enemy; but he had waited too long for he went only a few steps and fell, the victim of 8 50-caliber bullets.

We soon had him skinned and the meat cut off. About a mile farther we came to a spring of water and camped for the day. We had buffalo tenderloin and venison for our Christmas dinner. As soon as it was over I took a run. I saw no buffalo but shot my first deer, also 3 coyotes, and thought it a wonderful Christmas for me.

The next morning we again started Southwest, crossing the North Canadian river about $\frac{1}{2}$ mile from camp and there I saw the coveted cattle. After getting to the high ground it was buffalo everywhere.

John handed me his Sharps sighted for 100 yards, half way to the hump 150, and top of hump 200 yards, which he said was as far as I would wish to shoot. The game was feeding in a ravine, and we had no trouble to get within 50 yards. Bill was to shoot, as he knew just where, and I was to wait until told to fire. He shot, but did not strike within a foot of where he had intended to. The buffalo started, but stopped and looked back at about 150 yards. After some persuasion, Bill let me shoot and down went a cow. The others showed no signs of running, and Bill said we would get a closer stand.

"Why not shoot from here?"

"Too far. That hit was an accident."

I felt flattered, but moved around after Bill to the other side of the bunch and to about 60 yards distance. By that time the cow I had shot was on her feet and was blundering about. Bill told me to shoot her again, as she would lead the bunch away.

"You shoot one, and I will drop her at the crack of your gun," I said, so he shot again, but struck the ground between us and the buffalo, and the ball went screaming over them. That started them on a wild run.

"Give it to them, they won't stop again," shouted Bill, and I obeyed, firing about 2 shots to his one. When I quit there were 6 buffalo on their feet, but 10 down. Seven fell at the crack of my gun and Bill knocked down another.

Thus ended my first day among the buffalo. We dressed the carcasses so the meat would be all right the next morning. Then we went to camp, tired and hungry, but happy.



A GOOD PAIR TO DRAW TO.

AMATEUR PHOTO BY E. F. POPE.

Winner of 6th Prize in RECREATION'S 8th Annual Photo Competition. Made with a Korona Camera.

THE HAUNTED MOUNTAIN.

MOSES THOMPSON, JR.

English as she is writ.

In Ye Olden Times. Two (2) Irishmen's first in America. In the north western part of America, "A mountain near a large city about fifteen miles away, and only could be reached by the Southwestern part only by one way. that way was to cross a mighty high mountain. this mountain after about 100 years of age that before any one began to settle around same and the first family that had made it up in their minds to locate at the foot of this great mountain thus leading to the principal city. After they had made that place their homes for some years to past the way to this city over this mountain, traffic robbers had made the top of this large mountain a safe place to rob travelers and to take their lives if necessary. After such deeds had been committed so often that the top of this place became haunted and prevented traffic traveling of the traveler over the mountain. So after many people had been frightened by Ghost's and *Haunts* they found that the traffic over the mountain was imposible to accomidate. So they had to reerect a road around this place twenty miles out of the way so that people could travel. after that road was completed a short while afterwards trafic began its regular travel without any trouble. So one evening two Irishmen's had come to a halt at the foot of the mountain and had lost their guide of the City where they was bound for. this time they had traveled all day and night had fallen upon them at the foot of this Mountain. what next said pat we are lost be-jasus. but Mike says look Pat there is a light younder some one live there suppose we go and ask about the route. they went to the light where they seen deemly burning and stoped and called. So there was a Woman and Three Children appeared as if they had been deserted, the two Irishmen ask them how far was they from the City. the Woman in the door replied gentlemens Y'se about fifteen miles from the City over the mountain and if you go around the road way that leads to the right you will make it about twenty five miles to go, as to the top of the mountain. have been posted no travelers are allowed to cross the mountain after dark as

they would be frighten to death. the reply of the two irishmen we want to know the nearest way to the City we care nothing about haunts. so if the mountain is the nearest way we will take that route thank you mum as they bided her good night and went on their jurney across the mountain. my this time they had taken up time asking the route to go it had fallen dark good. So up the mountain they went and soon reached the top where-upon they was attacked by a forward Dim Light. with a Voice never before had been heard. At the top they reached and after doing so it was so dark that you could not see your hands before you. nearer and rearer the Dim light approached towards the two men with a noise that could not be understood a distance but when it come nearer to them they understood such words approaching them. with a little Dim red light saying. Where must I put it. Where must I put it where must I put it. dingerling-dingerling-dingerling the noise of a small bell was heard. but quickly stoped Pat & Mike, Pat says to Mike faith and be-jasus what is that Pat? Pat says to Mike, I don't know perhaps that is one of them haunts trying frighten us, All at once the light seem to be upon them good enough to realize what it was but could not. but Mike quickly spoke and said to the little Dim Light which was near. in such Tones as Mike Repeated. haint that a nice word for you to ask a man stop him in the night like this and ask him where shall you Put it. Go Put It Where You Got It. Where did You Get It. Thats a h—ll of a word to ask a gentleman, where shall you put it go put it where you got it. at these words the light banhished away and was gone and nothing more seen that night as they crossed the mountain en-route to the City. After that night with Pat and Mike's Experience no such Ghost ever appearde again. Its is always said by Older people that if you speak to Ghost that they will never no more appear especialy in the right way words like this. What in the name of the lord you want in this poor Sinfull World. Pat and Mikes, Wasn't that Way.

She: Tell me, why do you love me?
Why,—er—er—I suppose because fools
rush in where angels fear to tread.—Life.



DON'T BOTHER ME. I'M BUSY.

AMATEUR PHOTO BY A. S. GOSS.

Winner of 7th Prize in RECREATION'S 8th Annual Photo Competition. Made with a Poco Camera.

THE PAWNEE UPRISING OF 1859.

HOWARD W. BELL.

In the summer of 1859 the entire tribe of Pawnees, braves, squaws, papposes and dogs, left their 2 villages, 12 miles South of Fontenelle, Nebraska, on the South side of the Platte river, marched across the lowland between the Platte and Elkhorn rivers, and camped on the Western side of the Elkhorn, just across from Fontenelle. They claimed to be going on a grand buffalo hunt, to last several moons. The next day half a dozen bucks crossed the river about 12 miles above Fontenelle, and attacked an old bachelor who was living alone in a little log hut. The bucks showed emphatically their disapproval of celibacy by taking \$136, a package of valuable papers and a yoke of oxen, and by drinking all the settler's whiskey and locking him in his shanty. Three hours later the settler broke open to freedom, and made his way to Fontenelle, where the alarm quickly spread. A company of a dozen men was organized, and an advance was made on the scene of the outrage. No Indians were discovered and the company returned to Fontenelle and disbanded. Two days afterward the people living at West Point came down to Fontenelle in a body, and reported that marauding bands of Pawnees had burned the homes of the settlers, and ripped up their feather beds, scattering the contents to the winds, and reserving the ticks to be used as blankets. Clocks had been torn to pieces in search of brass wheels to hang in the savages' ears; cattle and horses had been freely confiscated.

Here was cause for war. The campaign opened the next morning. Thirty men, armed with rifles and revolvers, started for West Point in wagons. When they reached there arrangements were made to capture the Indians. A few of the settlers took positions in one room of a double log house, while the others kept out of sight. The people of the house were instructed to admit the Indians into the unoccupied room, and after they were all in, to fasten the outside door securely. The door between the rooms was then to be opened, the white men were to rush from the room in which they were concealed into that occupied by the Indians, and the capture of the savages would be easy.

The Indians, 11 in number, approached the house, were invited to walk in, and accepted. The outside door was fastened; the signal was given; the door between the 2 rooms was opened; the white men rushed with a yell into the room which was occupied by the Indians, and—captured the whole

posse? Not much. The greasy, slippery devils shed their blankets, dived down among the legs of the white men, slipped out like eels, burst open the door and were out of the room like a flash. All the white men had to show for their stratagem was a slug in the wrist of one of their own number. The whites followed the Indians out of the house and blazed away at them as they ran toward the river. Two or 3 of the Indians were killed and one was wounded. The whites captured him, having brought him down on the wing by a shot which should have been better aimed.

The settlers then hastily assembled their wagons, put the wounded Indian in one of them, and started back to Fontenelle. They had not gone far when the Indian gave evidence of being dead. He was closely examined by those in the wagon, who agreed that he was a goner. As it would not pay to haul dead Indians, the wagon was driven to the bank of the Elkhorn near which the road ran, and the corpse was pitched into the river. As soon as the Indian struck the water he dived down and swam under water for the opposite bank. Even an Indian can not stay under water all the time; and when that red rascal broke the surface of the stream as he came up to get a whiff of air, a load of buckshot was deposited in the back of his head. He never reached the other side.

It was reported every day for a week that 10,000 Indians were approaching the town fully attired in the traditional war paint and feathers. The people were kept in excited suspense. At night each bush or shrub was transformed into a stealthily approaching redskin. This could not be borne long, so the hastily equipped militia soon took the offensive and marched in the direction of the Pawnee camps. Late one night they halted on the outskirts of the lodge and struck camp.

At 3 o'clock in the morning they were aroused and in a short time were on the move. At daylight the Indian camp was seen, near the junction of a small stream with the river. A large extent of ground was covered by the lodges, and here and there Indians glided about, unconscious of the approach of an enemy. In a few moments, however, they discovered the whites, the camp vanished like magic and in an incredibly short time the wide river bottom was swarming with redskins, some mounted, some on foot, all shouting and yelling, striving to make their escape. They leveled their lodges to the ground but did

not attempt to take them away. They thought only to save themselves. The Omahas encamped with the Pawnees did not run, neither did they strike their tents, but remained in them, knowing they had no reason to fear the whites.

The mounted settlers crossed the stream at once and followed the flying Pawnees, but some time was lost in getting the wagons across the miry stream. Finally the entire force was safely landed on the Western side of the creek and moved up the river. The tall slough grass through which they passed concealed a good many of the weaker ones among the Indians, who, finding themselves unable to keep up with the others, had dropped down in the rank grass hoping to be passed by. On either side could be heard the cries and yells of papposes thrown away by the frightened squaws in their endeavor to travel light. Small dogs, pet badgers, wolves and "sich" had also been left by their masters to shift for themselves, and they added their cries to the noise and confusion. In a short time not an Indian was to be seen where but half an hour before thousands had swarmed. They had taken shelter among the willows on the river bank and in the breaks along the bluffs on either side of it.

They did not permanently escape. An under chief of the Pawnees, a fat old codger who was trying to get away on foot, was overtaken by a horseman who shot at him and missed him. Just as the horseman had secured a better aim for a second attempt the Indian threw up his hands and surrendered. He was told to call his tribe together for a parley immediately or he would be killed. The Indian was glad of this chance for saving his life and at once set up a series of terrific yells, in answer to which redskins lifted their heads and approached with caution, when the prisoner explained that a parley with the "Cherokee man" was necessary.

By that time the scattered white forces had gathered, the wagons were corralled and a line of battle was formed with a 6 pound brass piece in front and the horsemen on the flanks. When the Indians who were looking about, discovered the weakness of the force they had been running from, they left their hiding places and approached readily. They were ordered to keep a respectful distance in front and only the chiefs were allowed to come to the wagons. The Indian force constantly received additions to its numbers, and before an hour had passed the whites were confronted by about 2,000 redskins. The Pawnee chiefs were told that they could have their choice of giving up the braves who had been engaged in the robbing and burning about West Point and paying the expenses of the expe-

dition out of moneys due them from the government, or of fighting.

It was finally arranged, after several hours' discussion, that the terms proposed would be acceded to. Then began a hunt for the braves who had been raising Cain in the settlements. By the middle of the afternoon 7 young fellows were tied behind one of the wagons and the party was moving toward a suitable place to camp for the night.

When the young Indians were given up, a squaw belonging to one of them insisted on being allowed to go with her brave. When this request was denied, she screamed and cried, tore the hair out of her head by great handfuls, threw her arms around the young fellow's neck and gave way to the most violent grief. She was dragged away from him with difficulty, and the party proceeded, traveling but a few miles before going into camp. One of the prisoners seemed to be suffering greatly and one of the doctors made an examination. He found that the brave had been shot through the body and that the wound was mortifying. The young fellow was one of the party of 11 who had been shut up in the room at West Point and he had been shot in running from the house. The doctor said he would not live to reach the settlements. He was therefore set free and told to go back to his tribe. He was found dead the next morning a short distance from camp.

Having struck camp, a supper of black coffee, fat bacon, molasses and a certain kind of hot bread peculiar to the plains was prepared and eaten with relish.

Early the next morning the march was resumed. Within a few miles the company reached a high point of ground from which a magnificent and picturesque scene burst on their view. At their feet was the Indian camp, then a scene of active commotion, for the red men had just discovered the approach of the whites and were rapidly gathering their ponies from the neighboring hills. It was a mutual surprise. The whites had supposed the Indians would remain for the night at the place where the powwow was held, and the Indians thought the settlers had turned back that morning intending to go home by the route they had come.

It was decided to get everything ready to repel an attack, move along as if the Indians were not there and trust to Fate for the rest. The 6 prisoners were tied together and fastened by a rope to one of the wagons, behind which they trudged quietly, surrounded by a mounted guard. The company did not go through the camp, but passed along one side of it. A few squaws and papposes came out to see them as they moved past, but the Indians generally remained about their tents. Among the squaws

was the one who had exhibited such intense grief at the separation from her brave the day before. When the wagon behind which the prisoners were tied reached her she rushed among them and gave her Indian a knife, with which he stabbed himself in the breast. As he fell heavily to the ground the wagon stopped and the guards gave attention to the wounded Indian. No blood was to be seen about the wounds, but a reddish substance resembling blood oozed from each corner of his mouth. As the guards were doing what they could to assist him, his faithful squaw seized the knife and cut the ropes which bound the prisoners together. Away they sprang like a flash, all the guards but one running after them, firing as they ran. Meanwhile the wounded Indian had stretched out, his eyes sank into his head and he gave every indication of being dead, while his squaw hung over him indulging in wild expressions of grief. When she saw that the guards were busy in their pursuit of the liberated Pawnees, she gave her buck the signal and he leaped to his feet, as agile as a cat, and started to run. He did not go far. One guard had remained to keep an eye on the corpse and when that corpse attempted to run away the guard drew up his rifle and called "halt." The Indian halted and it was then found

that the wound he had given himself was only skin deep and that he had red ochre in his mouth. He was recaptured, tied behind the wagon and the procession moved on.

The settlers proceeded about a mile and stopped on a high hill for consultation. The guards who had pursued the escaped prisoners returned to the command and reported that they had killed or wounded all the prisoners except the one who had been recaptured. This was well enough, but in the excitement of the chase they had popped over an Omaha brave and had killed an Omaha pony. The result of this was a visit from a deputation of the Omahas, prepared for either war or peace as circumstances might dictate. After hours of talk they finally agreed that if the whites would leave medicine for the wounded Indians and pay for the pony they had killed, the Omahas would not fight. To these conditions the settlers assented cheerfully.

On the homeward march the whites celebrated freely. It was supposed that the Government would enforce the contract with the Indians and keep back enough funds to pay the expenses of the expedition, but the Government ignored the settlers, paid the Pawnees all that was due them, and the noble white men were left to whistle for their pay. They are whistling yet.

HIAWATHA.

JABOX.

In history books we all may read,
How bleeding Kansas used to bleed;
How old John Brown and his shot gun
Sent slavery scooting on a run;
But now a something comes to stay,
A so-called tune, born in a day,
Which, some think, adds to Kansas' fame;
This tune rejoices in the name
Of Hiawatha.

In Kansas, oratorical stunts
Were done by John J. Ingalls once.
He soared aloft, then sad to tell,
Too much hot air, and down he fell.
But Kansas, advertised by him,
Was misty, vague, opaque and dim,
When put beside this modern boast,
This tinkling tune that rules the roost,
This Hiawatha.

Again, the populist came forth,
Ravaged the land from South to North,
His native heath, his natal lair
Was Kansas, so they all declare;
But what was he, done for so soon,
Compared with this outrageous tune,
This Hiawatha.

The Nation's Carrie, axe in hand,
From Kansas swept across our land;
Her antics and her grotesque face
Gained far too much newspaper space;
But Carrie's glory dims and pales
Before the jiggly, wiggly wails
Of Hiawatha.

Old Egypt's seven plagues have vexed,
Have tortured, harassed and perplexed
The State of Kansas, blizzard swept,
Grasshopper bitten, cyclone ripped,
But now the worst of all descends;
A cruel Fate on Kansas sends
This Hiawatha.

The multifarious cereal,
A hundred tricks of Belial,
The isms and the fads of earth
Have mostly had a Kansas birth;
But save us, men and angels, save,
Lest we go down into the grave
And shuffle off our earthly pains
While listening to the maddening strains,
The racking, pestering, sickening, blithering
strains
Of Hiawatha.

THE HUDSON BAY COMPANY.

S. A. PADDOCK.

In 1670 a party of men bound together under the name of the Hudson Bay Company, came to America for the purpose of carrying on a fur trade with the Indians, and immediately built a few forts along the cheerless shores of the vast, landlocked body of water from which their company derived its name. They were under the patronage of Prince Rupert, second cousin to Charles II. Their charter gave them the grant of exclusive trade, besides full possession in perpetuity of all lands in the watershed of Hudson bay. A lucrative trade with the redskins was soon established, and large dividends were paid to the fortunate shareholders until near the close of the 18th century. Then the company's prosperity began to be seriously affected by the energetic competition of Canadian fur traders.

While Canada was owned by the French, the Company, because of the monopoly which it enjoyed, carried on its business in anything but an enterprising way. It was content to wait on the coast for furs to be brought to it, instead of pushing into the interior and sending forth agents. The conquest of Canada by England in 1761 revolutionized the fur trade and, indeed, ruined it for several years. Then the British began trading with the Western Indian tribes, and worked farther and farther into the forest until the Athabasca and Churchill rivers were finally reached.

The Hudson Bay Company was roused from its torpor by the competition of other traders and in 1774 established a fort on Sturgeon lake. Up to that time almost nothing had been done toward the exploration of its extensive territories.

The same year an obstacle more serious than the opposition of a rival company arose in the shape of a conspiracy among the Indians to exterminate the traders. But it was the redskins who were exterminated, or nearly so; not by the paleface, but by that dread disease, the smallpox. The scourge raged until only a few insurgent natives remained alive. That conspiracy was the direct cause of the consolidation of the scattered Canadian fur traders into an association, consisting of 16 and later of 30 partners, under the name of the Northwest Company of Canada. It strove vigorously but vainly to force the Hudson Bay Company out of the field. Its agents busied themselves with exploring the vast territory of Canada, and established several trading posts. The most famous of their explorers was Alexander

Mackenzie who, in 1789, reached the Arctic ocean and discovered the mouth of the great river which now bears his name. Later he crossed the Rocky mountains and followed the Fraser river to its mouth in Georgian gulf.

Thus it came about that the new company in time ruled the country from the Canadian lakes to the Rockies. It even encroached on its rival's territory to the North and forced it to act or be wiped out of existence. Accordingly the original company pushed its posts farther into the interior, and in 1821 established a settlement on Red River, South of Lake Winnipeg, thus putting an obstacle in the way of its competitor. The Northwest Company was not inclined to tolerate this, and a mighty quarrel broke out, resulting in a war, lasting 2 years and ending only when the Red River settlers were forced from their position after the murder of Semple, their governor, in 1816. Though that was the end of active warfare it was not until 1821 that the terrible feud came to an end. It must be remembered that at that time law had little force in the trackless wilderness.

The feud had a most demoralizing effect on the Indians, for both sides, each endeavoring to swell the numbers of its allies, supplied whiskey in unlimited quantities to the Indians. As a consequence the whole region became the scene of battle, and if it had long continued the most important tribes would probably have been exterminated.

The income from the fur trade was rapidly diminished until both companies were forced to discontinue dividends. This state of affairs existed about 6 years. It was seen that if the feud did not soon end both parties would be ruined. There was but one thing to do, and that was to band together into one company. This they did in 1821, under the old name of the Hudson Bay Company. After that, the former enemies, working for mutual benefit, prospered and were soon able to pay half yearly dividends of 5 per cent.

The Indians also prospered, for whiskey was denied them by the Company. In fact, the savages had to go without fire water until 1873, when whiskey smugglers from the United States supplied them with it. The wily smugglers returned across the boundary with their wagons loaded with furs and in certain parts of the country the Company's great warehouses remained empty throughout the year.

The Canadian Government was called on

for aid, and laws prohibiting the introduction of malt and spirituous liquors into the Northwest Territories were immediately passed. Moreover, the organization now known as the Northwest mounted police was charged to enforce them.

Soon after the formation of the new Hudson Bay Company, the British Government granted it a license—terminable in 21 years, but renewed for a like term in 1838—of exclusive trade throughout the territory from Labrador to the Pacific, and from the Red river to the Polar ocean. Twenty-eight years later the Government granted a further license of exclusive trade and management over Vancouver Island to prevent its being annexed by the United States. The Company then held control of 4,000,000 square miles of territory and its yearly profits were immense, amounting to £81,000 with a paid up capital of £400,000. It was reconstructed in 1863 with a capital of £2,000,000 for the purpose of enlarging its field of operation.

Over that vast country about 200 trading posts have been established. These forts are without exception placed on the shore of some lake or river so furs may be easily transported. The business of the larger forts with the Indians is carried on by a chief trader and a general administrator. About 3,500 clerks, postmasters, surgeons, etc. are employed, and nearly 100,000 hunters and trappers, both white and Indian, serve the great corporation. Many ocean vessels are employed on the Northwest coast to carry on trade with the natives. Forty years ago this trade alone employed 1,000 men, 5 armed sailing vessels and one armed steamer.

During the short season when the Northern lakes and rivers are navigable the accumulated furs are transported in canoes to York or Moose Factory on Hudson bay, thence either to Montreal or Vancouver. Ultimately most of them go to London. It takes many months for furs to reach their destination from far points in the interior, on account of the numerous rapids and portages to be passed, and, above all, because of the long winter.

The Company annually exports £150,000 to £200,000 worth of peltries to England, besides exchanging many pelts for Russian and American furs; while a large number are exported direct to China. - The profits are immense. Money or goods from 5 to 75 cents in value is given to the Indian for a marten skin worth \$10 to \$30. For a \$500 fox skin poor Lo receives but little more.

The Company claims that its influence over its savage dependents has been beneficial. So it has, for itself, at least. Whether the conversion of a free, hardy, frugal and self reliant savage into a lazy, dependent, drunken and diseased being, practically enslaved by a vast monopoly, is a gain to the world at large, may well be questioned.

Moose Factory is over 200 years old, and has for some time been the main port on James bay. There are situated the head offices for the region; and, as the vessel from England lands all supplies there, it is the center of distribution for the whole bay. The population is about 200, consisting exclusively of Company employees and their families. Several hundred Indians are connected with the post. A small saw mill manufactures lumber for all the posts in the region. A boat building shop is also maintained, which has turned out vessels capable of crossing the open bay.

Moose Factory is also the headquarters of the missionary diocese of Mooseone. A substantial church has been erected, as well as a residence for the bishop. Outlying stations have been established at Fort Hope, Fort Albany, York Fort, Rupert's House, etc. The Indians are all nominally Christians; most of them are able to speak English and to read in their own language (Swampy Cree). They use a system of phonetic spelling well adapted to the language. South of New Post the Indians are Ojibways, and adherents of the Roman Catholic church. They do not use the phonetic writing, but can write in the ordinary characters as taught by the Catholic missionaries.

The Guide: Well, here we are on the peak at last.

The Tourist: Do you mean we can get no higher? Don't say that I can ascend no farther!

The Guide: Well, you can climb up this alpenstock if you want to. It's 7 feet long.

—Chicago Tribune.

VENEERED HUMAN NATURE.

GRANT WALLACE.

In the San Francisco Bulletin.

All healthy and normal souls love the society of trees and mountains. What a relief to be away for a season from the crowded pavements and the marts of sordid men, where familiarity begets contempt and weariness of spirit, to the wilderness of crags and pines, fresh and inspiring as when spilled from the hand of the Creator, where familiarity begets only respect and tenderness!

Forever, the highest wisdom springs from the tenderest feelings. Your laboratory scientist, coldly intellectual, unemotional, may observe external facts, and tabulate and compare; but he shall never lay hold on the big, eternal truths of life until he lets emotion play under intellect, even as the flame plays under the crucible of cold minerals in his laboratory. Then the gold cometh.

Your city man comes forth encrusted with materiality, functioning brilliantly enough on the mental plane, but lacking in that close sympathy with his brother men and his brother beasts and birds and that tender interest in and consideration for their lives and comfort which the quiet, observant rustic displays.

The city for intellect, the country for genuine human feeling. The city for smug, refined hypocrisy in half the acts of life, the country for uncouth candor and unmanicured sincerity.

For the most astounding examples of ironed and perfumed savagery, commend me to the urban product. The countryman, particularly the mountaineer, who has time for mediation, may wear clothes that do not fit him; he may mispronounce some of his words; but, as a rule, he is genuine and tender souled; but he never shoots a deer if he does not need it.

The city either breaks or hardens the heart. It is ever the grave of innocence and wholesomeness and rest. The unnatural conditions of modern city life, the development of low cunning, the mad scramble for pelf and place, make brutes of men, and encase whatever of soul there may be left in them in a crust of heartless materiality, thick and impenetrable. Civilization has ever developed the physical and the intellectual at the expense of the psychic, the humane and the spiritual.

Such are a few of the reflections that crossed my mind as I lay, rolled in my blanket, on a luxurious and fragrant bed of yellow pine needles and blossoming wild buckwheat, in a gloomy rhus thicket on the

lonely summit of the Sierra de la Liebre mountains.

Range on range of sun-baked mountains, covering hundreds of square miles to the West and South, practically uninhabited save by the deer, the puma, the wildcat and the quail, had melted into hazy blue and had then merged into the general blackness. It was the heart of the deer country, and my duties as Government Ranger in the great forest reserve had been rendered doubly arduous for a month by the necessity of keeping a watchful eye on the bands of deer butchers from the cities, and in seeing that forest fires were not started from their camp fires.

These conscienceless hunters seem, many times, to take a vicious pleasure in seeing how rapidly and completely they can pull off their veneer of urban civilization and revert to their true characters of irresponsible savages, as soon as they are out of the sight of the blue coated policemen. Time after time, in ranging up and down the mountain streams of Ventura, Los Angeles, San Diego and San Bernardino counties, I have found the outlets of the trout pools dammed up where these gentlemen sportsmen from the city had waded in and thrown all the fish out on the banks, in order that they might carry into camp a great catch of 75 to 100 trout, and so make a record.

It is these same gentry who boast of shooting 100 doves a day, whether nesting or not; who slaughter mother does and tiny milk-drinking, spotted fawns, whenever the Ranger or the deputy game warden is not watching; who scatter leaden death among the mocking birds, the orioles and the little families of half grown quails, piping behind their mothers around the water-holes in the canyons, and whose motto is "Kill, kill! No matter what it is, kill!"

As I drowsed under the stars, I remembered how, a few hours before, in following the trail of a puma over the Liebre, it had led me to the recently abandoned camp of a party of 4 deer slayers, hard by the only water-hole in that region, I caught a glimpse of the tawny "terror of the mountains" as he slunk away, waving his long, black tipped tail with quick jerks as an angry house cat does. At the same time 2 coyotes and a family of silver foxes scampered away into the buckthorn chaparral at my approach. All had been devouring fragments of venison and gnawing at the half stripped carcasses of deer surrounding the abandoned camp.

I counted portions of 14 deer, large and small. Two spoiled hides lying near were clearly those of does, which it is never lawful to kill here. I am told the campers admitted killing 20 deer, in 2 weeks, by the murderous method of lying in wait at night at the spring and shooting them down as they came to quench their thirst.

These sportsmen are the highest product of our alleged civilization. All these 4 veneered savages are professional men; 2 being physicians who, having broken down their own health in a mad scramble to build up the health and deplete the pocketbooks of other people, had sought retirement in the wilderness to commune with nature with repeating rifles and pump guns loaded with buckshot. Health to them spelled death to every wild thing within range.

Yet, curious commentary on the helplessness of man, were these banal lead slingers to be deprived of their breech loaders and compelled to wrestle with the wilderness for an existence, they could not for a day compete with the chipmunk or the cottontail.

Were we to dub such sportsmen beasts we would owe an apology to the 4 footed ones, for none, save the puma and the grizzly bear when angered, will kill more than it needs. Only man kills for the mere sake of killing. Only civilized man swings the besom of annihilation. It was not the Indians who annihilated the millions of bison on our plains. It was sportsmen such as I am describing.

One night I was awakened at 2 o'clock by the blood-chilling cry of a mountain lion. A little later, from a distance came the sound of squealing, and the "woof-woof!" of terrified pigs. On my way down the mountain next morning I passed the spot, an ancient hog corral built of chemisal brush, in which possibly 2 dozen wild hogs had taken refuge. There the lion had found them in the night, and with a savage ferocity almost equalling that of the college-bred deer butchers, he had struck dead 11 of the pigs. I found 5 or 6 others wandering about in the canyon, some with their throats or sides torn open, others with eyes scratched out; for the puma strikes with

extended, rigid claws, and the results are frightful.

I have found does wounded and left to die by heartless gunners, and birds and fishes killed for the sake of killing, and thrown away.

A friend, a mountaineer, had half a dozen pet does and fawns which fed with his cattle, and which he prized highly. While absent one day some city sportsmen killed all of them.

All sounds are musical in the woods, save the crack of a rifle. There is nothing more terrible than case hardened, pavement civilization with a gun. It is not the settlers, many of whom do not kill one deer apiece per year, but the kid glove type of hunter from the city who slaughters remorselessly, and sweeps the California hills clear of every form of wild life.

They are as senselessly destructive as the ravening kangaroo rats which carry off my spoons and pencils; objects entirely useless to them. These men are the pickpockets of Nature, nor have they the excuse of the wild justice of revenge, or the necessity of self protection. Ancestral blindness wraps them up.

To remonstrate with such men is like feeding meat to a horse. Had they other eyes than those of corded fat and gristle they might get far greater pleasure out of hunting the wild creatures of the wood with a camera; and they would find it would require greater patience, knowledge and acumen to still hunt thus, than to make the ground wet with the blood of fawns and orioles.

Year after year these cultivated victims of the continuous calamity of blood-thirstiness are permitted to roam the woods and mountains, blind to all the real beauty about them, forever gripping a long range gun and groping about, like the puma or the giant in the nursery tale, with his "Fee-fo-fum," smelling blood and prey. At this rate it is only a question of a few years when there will be left in California neither game nor songsters larger than the cicada.

May the gods endow such Goths and Huns of the fields with a conscience, equal at least, to that of the wolf, which kills only what it needs!

"Oh, yes, I've opened an office," said the young lawyer; "you may remember that you saw me buying an alarm clock the other day."

"Yes," replied his friend; "you have to get up early these mornings, eh?"

"O, no. I use it to wake me up, when it's time to go home."—Philadelphia Press.

SEA TROUT GALORE.

GOLD DUST.

During a great blizzard which extended over the entire country East of the Rockies, a friend and I were in camp on the banks of New river. New river is 40 miles North of Wilmington, North Carolina, and for 25 miles is a tide water stream varying in width from one to 5 miles, and in depth from one to 35 feet.

The population of the surrounding country is composed almost wholly of that class of whites known in the South as Crackers, and of a low type of negro. All the people living near the river are fishermen, but they also plant a little land with corn, cotton and sweet potatoes.

The blizzard, which they term in the South a "freeze," lasted from February 9th to 15th. Snow fell to the depth of 8 inches, accompanied by a severe Northern gale, and the oldest inhabitants said it was the longest and most severe freeze they could remember. The temperature fell to zero during the night of the 11th, and ice formed in many places on the river to the depth of 4 inches. Though the people suffered extremely from cold they were jubilant over the prospect of a large catch of fish, as the freezing of the river killed the fish that were in shallow water.

New river and White Oak river are known throughout the South as the best feeding grounds for mullet. Sea trout come up both rivers with the tide to feed on mullet, their principal food.

Matt and Ben Taylor, 2 old fishermen, suggested that we join forces with them and take part in the grand scramble for trout as soon as the river broke up. That occurred during the night of February 15th.

The next morning we were astir bright and early. We set out for the river, taking an axe to break our way to clear water. After a hard struggle we succeeded in floating the boats, and were the first fishermen on the scene. The sudden change from cold to warm weather broke the ice and caused heavy fog.

After rowing a half mile or so up stream we saw dead trout floating on the surface; then the fun began. We had been out but a short time when the wind changed from South to Southwest and lifted the fog. When we were seen at work gathering the harvest of trout, boats were pushed out from every point. In a few minutes it seemed as if the entire population was on the river. A general scramble ensued as to who should gather most of the harvest. These harvests of fish occur only once in

4 or 5 years, and then last only a few hours; and all manner of craft are impressed into use. The women, both white and black, take a hand with the men.

To add to the excitement and our great discomfort, a heavy Northwesterly wind sprang up, blowing almost a gale. By that time we had our boat full to the gunwale. Being in the middle of the river, it was a question whether we could reach the shore with our cargo or would be obliged to throw it overboard to keep from swamping. Each heavy sea broke over us and added a bucketful or more of water to that already in the boat.

While Matt handled the oars I bailed in double quick time with an immense gourd. We succeeded after tremendous effort in reaching the float ice along the shore, but here our troubles really began. Our boat was so heavily loaded that the gunwale was but little above the surface of the water. The waves dashed the heavy ice against us until we expected the next swell would send us to the bottom. Matt, after great difficulty, brought the boat sufficiently near the shore to allow us to jump overboard; then taking hold of the gunwale we drew the boat in to land.

On counting our fish we found we had a few over 500, weighing $2\frac{1}{2}$ to 13 pounds; averaging about 4 pounds each.

My friend and his fishing partner, Ben, were not so fortunate as Matt and I. They secured only about half a boatload of trout, but they escaped the exciting experience we had in making land and came in dry and warm. Matt and I were soaked to the skin with icy salt water. We were just 5 hours filling our boat and making land.

All trout caught in the river are iced, packed in barrels, and shipped to New York and Philadelphia where they usually bring 12 to 15 cents a pound; but owing to the thousands of fish caught during that "numb," and to a combination between the fish buyers, fishermen on the river were obliged to sell their fish for almost nothing. Seven cents was the highest price paid for any; and we were fortunate in selling ours for that. A great many fish were sold for 3 and 4 cents, and some as low as 2 cents each.

The salt water trout of the South resembles in form the landlocked salmon, and in color the California brown trout. The flesh before cooking has the pink color of the brook trout and is like it when cooked, being delicious in flavor, and exceedingly rich.

AN IMPSON VALLEY FOX HUNT.

R. J. LONG.

A few nights ago some one on the edge of town wound a few blasts on a hunting horn; for what purpose I do not know. It may have been a recall to some errant dog or it may have been that the musician simply wanted to refresh his ear with the mellow notes. Whatever his object he did one thing, and that was oscillate the brain cell containing the memory of my first and last fox hunt.

Before that hunt I had been a scoffer at the enthusiasm shown by devotees of the chase. "What sport," I asked, "can be found riding across country frosty nights listening to the bawling of a lot of hounds?" Those to whom this question was addressed, knowing my love for all other forms of sport, would perhaps inquire, "Did you ever run a fox?" On my admitting that I never had, they would express their contempt for my ignorance.

How I came to be converted was in this way: Ben Bedford, one of the wildest hunters that ever tore along in the wake of a bugling pack, won the love of a bright eyed Indian girl attending school in this city. After their marriage, Ben suffered the fire in his smithy to go out and moved to Indian Territory, setting up as a way-side Vulcan in the beautiful valley of Impson, 25 miles from the nearest railroad. Ben prospered. There was much horse shoeing and other work for a clever smith like Ben, and besides Choctaw marriage had given him the right to fence and cultivate, or rent to others, as much land as he cared to. Saxon like, Ben had a good eye for fertile soil. Game was abundant; the waters teemed with fish; his hounds were lean and hard and the gray foxes gave him the sport he loved best.

When Ben wrote to his brother-in-law, Kinzie Pickard, and me, in the fall of 1900, to come and hunt, I was made glad. We took along the bird dogs, for I have ever been, in lawful season, a pesterer of whirling Robert White. Ben's wife was away on a long visit, but as each man was a competent cook we fared well. I am not going to tell how the bass bit in Ten Mile, Buck and Cypress creeks; how Kinzie killed red squirrels in the bottoms; or how I fogged up the birds over old Faust and Pancho. It is enough to say that we feasted on bass, birds, and turkey breast.

We had been there 10 days, and Kinzie announced one morning that he purposed running a fox that night. I told him he might run a fox if he wanted to, but that I did not propose to engage in any such

silliness. They worked on me that day with argument and threat until I reluctantly consented to go. Preparation began at nightfall. Tom Click, a neighbor, could not go, but contributed 7 lank, lean music boxes, while we had 6. Meanwhile a great and unpleasant suspicion had grown upon me. From certain glances I had intercepted and chuckles overheard I concluded that I was to be ridden to death or lost in the hills; so when we selected our horses I chose a black mare of racing strain, the fastest thing in those parts. They might ride me to a frazzle, but run away from me, never.

It was a great white night, the 6th of November, when we started down the valley with the shadowy figures of the dogs trotting around and before us. Ben and Kinzie were joyous and elated, while I was silent and dubious. I was dissatisfied. Always thin blooded, the frosty air was biting me; my dissatisfaction increased. My companions drew rein about 2 miles from home and sat listening. The dogs had been on forages on each side of the road, but without any decided results. Presently Ben remarked:

"They ought to strike somewhere in here."

"Yes," I snarled, "and we ought to be at home in bed."

"Shut up!" retorted Pickard, and silence ensued. A few minutes we sat thus, when far to South of us sounded a cry that was like mellow wine to the blood. It was the voice of that good old campaigner, Drive; he who had thrashed and dominated every pack he ever ran with. The cry was answered from all sides. Two of Click's dogs darted across the road. Kinzie and Ben were pounding the road 50 yards away, and the black mare was tugging to go. I loosed her rein and found myself tearing along in my first fox chase. It was easy sailing a while, but we soon turned off into a bottom road that was ugly and where the shadows lay deep. There was no slackening of what seemed to me a desperate pace. Emerging, a long ridge lay bare and white before us; gaining its crest every note of a wonderful chorus floated up to us. I was glad I came; my blood was popping hot; all else was forgotten in the witchery of moonlight and riotous melody. I was at once a full fledged fox hunter.

There was tacking a while in the scant brush, and then the chase led straightaway. Helter skelter we went down the ridge in

pursuit. It seemed the fox was trying to outrun his pursuers in a straightaway dash. We struck a good road running our way, and what racing there was to catch up with the pack! We heard them tree, but before we got there the fox was killed. Jim Blackburn, living on the road, had heard the dogs and been unable to stay in bed; his dogs had joined ours, and when he rode to where they had treed, the fox sprang out and was killed. It was a large dog fox, and after some discussion it was decided to return and find its mate.

This resulted in what the others declared one of the finest runs they ever participated in. My Lady Fox was soon discovered, and put up a run for life and liberty that for cunning, gameness and endurance won my profound admiration. Once she passed us sitting still on our horses, in plain view, slipping like a fading shadow into the bushes that lined the little creek. Never getting out of hearing, seemingly loath to leave her accustomed walks, for nearly 3 hours she trailed, a deadly and musical choir in her wake. It was great! It was cruel and pitiful. It was magnificent, but I thought of her lord and master tied to my saddle bow, self-sacrificed in a vain endeavor to lead those speedy devils away from the vicinity of his lady love.

Finally my lady began to dodge her way to a dense swamp far in the North, where

in its tangled depths she might "gain refuge from her toil." Again the rapid ride put the blood lust in me, and when we drew rein on a hill overlooking the swamp every cruel instinct was awake, and I said to Pickard, "I should like to see the kill." "Come on," and he was flying down the road. It was dark in those depths except where the moonlight fell in patches; branches slashed me in the face; the green briar brought blood, but in my ears a bedlam of canine melody was ringing. It was soon over. We were within 30 steps when they caught her. Dismounting, we ran up to the snarling, snapping mass of dogs, dust and flying leaves, into which Pickard plunged, kicking right and left. When he emerged he held the form of my clever little lady, already growing stiff with death.

Then came the revulsion. While I said nothing, in my heart I hated a hound and grieved for the little lady done to death. I lay abed next morning and ached in every joint and tissue. I was congratulated on my conduct and change of heart, and I had to own that I had had magnificent sport. Magnificent it is; the wild riding in the moonlight, your pulses beating to the music of the pack; but when the dogs pile snapping and snarling on a little run down figure, and the leaves whirl and the dust rises it is cruel and pathetic.

TROUBLE WITH THE LAMBS.

A Kansas farmer who employed a football player on his farm last summer had a herd of sheep that was causing him no little trouble. He called the college man out into the pen about 6 o'clock one morning, and said that he wanted him to herd the sheep over to a certain place and then drive them slowly back, so as to have them in the pens by 7 o'clock that night. The new herder started out awkwardly, and the farmer returned to the stable.

Supper time came and not a word had been heard from the sheep. Finally at 8 o'clock the farmer began to be alarmed, and was getting ready to go out on a hunt, when he heard someone come whistling

through the yard, and in walked the new hand, all smiles and apparently not tired at all by his day's work.

"Kinder late. Hev any trouble?"

"Not much, thank you. Got along very nicely. But those 3 lambs did keep me busy, I will admit."

"Lambs! Ain't got a lamb in the hull bunch."

"Well, I guess you have, all right. They are in the pen now."

The farmer grabbed the young fellow by the arm, and they hurried to the pen. There, chasing about among the sheep, the farmer found 3 jack rabbits.—Kansas City Journal.

A MASTER OF THEORY.

G. A. MACK.

When first I met E. Mortimer Murtagoyd he was sitting in a grove of sugar maples, watching for grey squirrels. At least, he said he was watching for them and as he is big and aggressive looking, I took his word for it. His toggery was irreproachable. His corduroy jacket was neither too new nor too old. His leggings were briar scratched, yet not at all shabby. The forearm of his Savage showed a little wear, whether from his hand or a bit of emery cloth it was impossible to tell. Murtagoyd is a neighbor of mine and I had long been impressed by his exceedingly sportsmanlike air; therefore, with my most ingratiating smile, I inquired what success he had had.

"I have just come out," he replied. "Grey squirrels are most active from 4 to 6 p. m. If we remain quiet they will soon make their appearance."

"Probably—" I said, glancing at the surrounding maples, "probably to get syrup for their morning wheat cakes."

My companion paid no attention to this puerility, and I tried again. Said I:

"You have a Savage: I should have thought a .22 more suitable—"

"Do you mean .22-3-30, .22-5-35, .22-5-40, .22-7-40, .22-7-45, .22-8-45 or .22-13-45?"

"I had in mind the single shot," I babbled.

"Oh," said he, "the .22-13-45; an excellent cartridge in its way. Its m. v. f. s. is 1481: trajectory at 100 yards, 2.71; at 200 yards, 12.63; at 300, 33.67. It is capable of penetrating 5 $\frac{7}{8}$ -inch dry pine boards at 15 feet from muzzle; but the Savage miniature, .303-5 $\frac{1}{2}$ -100 is much better for small game, having more shocking power and a flatter trajectory. Its m. v. f. s. is—"

"Isn't that a squirrel?" I interrupted, pointing vaguely at a distant nothing.

Murtagoyd produced a field glass and looked in the direction indicated. Then he lowered the binocular and glanced suspiciously at me. Seeing no trace of guile in my countenance, he gazed again through the glass.

"Ah!" he exclaimed, "I see it now. It is a female, however, and I make it a rule to shoot only bucks."

Then, and until dusk, a flood of inside information rolled over me again; the while I thanked Heaven I had not met him earlier in the day. As we left the grove I suggested that had he been alone he would probably have been more successful in getting game.

"Yes," he assented; "I think your noisy

approach to the woods frightened the squirrels. A sportsman should above all cultivate noiseless celerity of movement. In walking through the forest tread softly on the ball of the foot, not permitting the heel to touch the ground; and be careful to avoid dry twigs."

He showed me how the thing should be done. As an exhibition of airy grace by a 180 pounder, it was well enough; as a demonstration of silent celerity, it rivalled the happiest efforts of a rheumatic cow.

Subsequently I called, by invitation, on Murtagoyd. He was, it appeared, at work in his study, and would I step up? I did so, and found him writing at a library table littered with MSS. and with gun catalogues and other works of reference.

"I'm glad to see you," he cried. "Sit down a minute, dear boy, until I finish this treatise."

The room was large and well furnished. On racks hung a small but choice collection of firearms, chiefly rifles of late design and high power. Every available inch of a large book case was filled with pamphlets and volumes relating to ballistics, guns and hunting. More literature of the same sort was heaped in corners. Photos and lithographs of game hung on the walls, interspersed with cartridge manufacturers' calendars. Presently Murtagoyd looked up.

"This writing is tedious work," he remarked, "but the public has such erroneous ideas about sport, and so much trash is written."

"Ah," I returned, "then you write for publication?"

"Oh, yes," he answered. "Here is a little thing of 12,000 words on 'Some experiments with the .30-40 soft point on the equine cadaver.' It is for the Dublin Sportsman. In it I illustrate, by anatomical diagrams, the fatal shots; also the probable course of bullets entering at given points. It is quite exhaustive."

"I can well believe it," I interjected.

"Yes," he continued, "for instance; one bullet entered at crest of frontal bone, followed the vertebral column, and the bulk lodged at root of tail. Fragments of the ball pierced every vital organ except the appendix vermiformis. Following out the dissection I traced bits of the jacket down both posterior limbs as far as the gambrels."

"Such a demonstration is of undoubted value to science," I remarked politely.

"And here," added my friend, "is a brochure of 20,000 ems for the London Field.

It is entitled 'Neurotic Lesions of Sportsmen,' and is in 3 parts. The first treats generally of hygiene from a sporting standpoint. It advocates daily cold tubbing, deep inhalations and avoidance of stimulants. The next is devoted to blinking, wincing, and other manifestations of gunshyness in man. The last discusses hysterical superexaltation following a successful shot."

"I presume," I said, "you write also for American publications."

"Well," he returned, "not often. You see, English periodicals accept work only from acknowledged authorities; and the disgusting blue pencil habit is not prevalent there. I once sent a brief article of 14,000 words to the leading magazine in this country devoted to sport. I mention no names, but it is published, I think, on West 24th Street. My contribution was on 'The more remote toxic effects of the copper patch on the vaso-motor nerves of the moose.' You will scarcely credit it, but my article appeared in print as an item of 247 words; and some of those were abbreviated!"

I murmured inarticulate sympathy. Then, after waiting for his emotion to subside, I ventured:

"You have a cosy den. I suppose you keep your trophies elsewhere, not caring to wager them on the efficiency of our fire department."

"Eh—yes," said Murtagoyd, "that is it. By the way, this is a charming day; take one of my guns and we will go shoot something."

"Why, really," I answered, "I know of nothing to shoot now except chucks."

"Then we will shoot chucks," he cried. "Take that Krag on the farther rack and come along."

"I'm a little shy of heavy artillery," I replied, "but I will watch you shoot."

"All right; but wait a moment," and he touched a bell. "Maggie," he said, when the girl appeared, "tea, ice, and lemons,"

and turning to me, "Let me offer you Some Russian tea; it's the only drink for a sportsman."

"It's too arctic for me," I rejoined. "If you have anything from the temperate zone, say Scotch——"

"My dear boy, I dare not give you such a nerve-racking concoction; at least, not until we return."

When the tea came, Murtagoyd drank one glass, then another.

"I'm in fine fettle to-day," he said, "I think I may venture on a third."

After he had consulted the thermometer and the barometer, we left the house, he carrying a Savage, and I, the field glass. We traversed a number of fields without finding game. At length, while peeping over a stone wall, I saw a woodchuck sitting on the little mound in front of his burrow, and pointed it out to my companion. He crouched behind the wall for some time, evidently calculating the distance. Then he looked at his watch, glanced at the sun, wet a finger and held it up to test the wind. All this while the quarry sat bolt upright. Murtagoyd took off his coat, laid it on the wall, and rested his rifle on it.

"I shall aim at the point of its shoulder," he announced. "Watch the effect through the glass."

Then he took a long breath, a still longer aim, and fired. Whether it was my imagination or was due to a flaw in the glass, I don't know, but I thought I saw the chuck wink at me. Anyway, with a derisive flourish of his narrative, he dived into the hole. I considerably kept my eyes averted from my companion.

"My calculations were absolutely correct," I heard him mutter. "That brute's name would have been Dennis, but for a spasmodic constriction of the muscles of my right eye. I must limit myself to 2 cups of tea."

Jack: That's a mighty good looking gown, Helen!

Helen: This old thing! It's so shiny I can see my face in it.

"That's probably why it's so good looking."—Exchange.

FROM THE GAME FIELDS.

The man who quits when he gets enough, with plenty of game still in sight, is a real sportsman.

A NEW YORK MAN WHO WEARS BRISTLES.

We went to Bathurst, N. B., September 16th, last, and on arrival there were informed by the game warden that H. A. Jackson, of New York city, and his party had gone up the Nepisquit river a week or so previous; that all but Jackson had taken out licences, but that he had told the game warden, Henry Bishop, that as he intended to hunt bear only, he would not take out a license.

The game warden asked us to keep a sharp lookout for Jackson, as he suspected Jackson meant to violate the law.

We arrived September 21st at our hunting grounds, and camped for the night. We intended to remain one week, but found there a Mr. Storm, a member of Jackson's party, and learned from him that Jackson had fired at a bull moose the night before and had wounded him. This moose we found dead 5 days later. Instead of staying a week at the ponds we moved the next morning, having a suspicion that Jackson had sneaked in 2 or 3 days before us to some other small ponds, distant about 12 miles from the South Branch ponds. We reached this latter hunting ground the night of September 22d, and Wednesday morning, September 23d, we met Jackson coming out. We accosted him and saw strapped on one of his guides a caribou head. Jackson admitted the head was his and we told him what we thought of him in forcible terms.

September 24th Mr. Smith was injured and had to come out of the woods. He arrived in Bathurst September 29th. He went at once to Mr. Bishop, the game warden, and preferred charges against Jackson for killing caribou without a license. Mr. Tilt, on going to the place where Jackson had killed his caribou, found 2 other carcasses of caribou, untouched, except that they had been shot. They were not killed for the heads, for they were spring calves. They were not even killed for meat, for not a pound of this had been taken. It was simply a case of wanton slaughter.

William Gray, Jackson's guide, is a thoroughly disreputable man, and is despised by nearly all his neighbors. He was, of course, a party to Jackson's unlawful work.

Yours truly,

Benjamin B. Tilt,
Abel I. Smith, Jr.

The facts regarding H. A. Jackson are as follows: When he and his party arrived in Bathurst from the woods, we had Jackson arrested on 2 charges, one of shooting a caribou, another of hunting

moose without a license. The party took out only 3 licenses, Mr. Jackson taking none. Jackson employed a lawyer and protested that he had not violated the law. He had some bear skins, which he claimed he shot, but said his friends had shot the 3 moose and one caribou, the heads of which they exposed here. You will note they showed only 3 moose heads here. When the trial came on we did not wish to be too severe on Jackson, and on his admitting the charge he was fined \$50 and costs, for the moose episode, and the party left town.

On their arrival at Bangor, the Daily Commercial published an article which made Jackson out to be a great Nimrod. In Bangor they said the party had 4 large moose heads, the largest one a beauty, having been killed by Jackson, and gave full particulars of their trip. A friend sent me a copy of the newspaper and I wrote the editor exposing Jackson's methods. My letter was published, and afterward copied into the St. John, N. B., Daily Telegraph and other papers. I send you copies of the 2 articles.

Since then, a guide told me Jackson had previously taken moose heads from here by splitting the skull and concealing the skull and antlers in his luggage.

I learned that Jackson or his party killed 3 more caribou on this last trip, and did not even skin them or take off the heads. They simply left the 3 carcasses to rot in the woods.

To further show that this man has been always a poacher, a man named Hotchkins, of Lambert's Lake, Me., who was here lately, tells me he had Jackson fined in Maine, some years ago, and that Jackson skipped out after putting up a deposit. There is also evidence to show that the Jackson party used their permit to catch a few trout at the Falls for catching salmon this year.

We have taken steps to prevent Mr. Jackson from getting any license here in future, and he will probably find that crooked work does not pay among sportsmen.

Yours truly,
H. Bishop, Game Warden, Bathurst, N. B.

I wrote Mr. Jackson as follows:

I understand you killed a moose in New Brunswick, September last, which had a record head. Will you kindly tell me whether this report is correct?

To which he replied:

New York City.

I send you the enclosed from Bangor paper.

A. H. Jackson.

Jackson does not confirm or deny the statement that he killed the moose, but the fact that he encloses a clipping from the Bangor Commercial which says he did, is equivalent to saying yes.

Here is a case that should be covered by international law, or by treaty. In the first place it appears Jackson went into the woods without a license, stating to the game warden that he was not going to kill any other game than bear. The laws of New Brunswick do not require a license to hunt these animals. It is clearly shown in the correspondence and the evidence produced in the New Brunswick courts, that Jackson killed 3 caribou and 2 moose, though he did not gather the first moose. It further appears that he sawed the skull of the big moose in 2 and secreted the head and horns in his trunk, bringing them out without letting the game warden know of his having them. William Gray, Jackson's guide, was a party to this fraud.

Then as soon as Jackson crossed the international boundary into Maine he commenced to boast to the newspaper reporters of having killed an unusually large moose. On his return to New York the Evening Telegram was furnished with 4 photographs, ostensibly made on this trip. One of these shows Jackson sitting behind a big moose head, which he claims to have killed. Another shows Frank Hays holding up a big salmon, which he is supposed to have caught.

Here is an extract from the Telegram's report of an interview with Frank Hays, a member of the Jackson party:

Jackson had a great adventure. He killed the biggest moose that has ever been taken out of New Brunswick. Don't know how much it weighed, but it looked as big as an elephant, and you can tell the size of the antlers in the picture by comparing them with the size of Jackson's head. It was a big bull. Jackson fell across him one day when he strayed away from us to get a record, and he got it.

I got a couple of moose, and whenever the gang wanted fish for breakfast it always fell to my lot to do the hooking. The picture would indicate that the fish I am holding is a salmon, but salmon were out of season while we were there; so it is not a salmon, but it was just as good as a salmon."

Jackson's number in the swine record is 957.

It is unfortunate that we have not a treaty with Canada which would allow an officer to come here, take Jackson across the line and try him in court for this flagrant violation of the New Brunswick law.

—EDITOR.

KERR AND POOLE ARE CONVICTED.

I hand you herewith a clipping from the St. Paul Globe, which details the finish of the Lakefield case. The sportsmen of Minnesota have been following this carefully, as it means great things for the preservation of game in this State. The warden shall receive the encouragement and approbation that are due him when he makes a good haul like this. RECREATION, the sportsman's best friend, will also be interested.

I trust that, while you are getting all kinds of abuse handed out to you by the conscience-stricken game hogs, you will remember that every right minded sportsman is with you, and that you will keep on roasting the hogs.

Chas. E. Scofield, Ortonville, Minn.

The clipping says:

Twenty thousand dollars in fines is the most favorable outlook that confronts William Kerr and Robert Poole, of Lakefield, convicted of complicity in the recent attempt to smuggle 3,000 wild ducks from this State into Iowa.

That estimate of the penalty assumes that the court will impose the minimum fine of \$10 for each bird; but if the maximum fine, \$25 for each bird, were to be exacted, the aggregate would be \$50,000.

The officers of the commission had known for some time that a wholesale business in smuggling game from this State was being carried on in the vicinity of Heron lake. Finally definite information came of a proposed shipment, and Captain William Bird and other officers of the commission located a large number of ducks and other game birds in warehouses at Lakefield controlled by Kerr, and watched them several nights, until final preparations for the removal of the birds were completed. Then the officers of the commission, with the sheriff of Jackson county, followed the wagons in which the birds were being conveyed, until they had nearly reached Montgomery, Iowa. At that point they halted the drivers of the wagons, who were induced to return across the State line into Minnesota, and then they were placed under arrest and the birds were seized. The confiscated game was shipped at once to this city and placed in cold storage. It was found that there were nearly 3,000 ducks in the lot.

In the indictments returned against Kerr and Poole, they were charged with having tried to ship illegally from the State of Minnesota 2,000 wild ducks, although the number seized was more than 3,000.

The case was tried at Jackson in the district court. It was earnestly contested

on both sides, and every point was hard fought. The jury found Kerr and Poole guilty as charged in the indictments, and a stay of sentence was granted pending a motion for a new trial, with the ultimate purpose of an appeal to the supreme court.

The fine can not be less than \$20,000 and may be \$50,000.

This is one of the most important game cases ever tried in this country, and it is earnestly hoped that the Supreme Court of Minnesota may sustain the decision of the Jackson Court. It is not likely that Kerr and Poole are well enough fixed to be able to pay a \$20,000 fine. If not, they should be compelled to go to jail and serve out that portion of the sentence which they can not liquidate in cash. This might mean a long term of imprisonment, but they men deserve it. They knew the law and knew the risk they were taking. They are known to be intelligent men, and if they see fit to carry on such a disreputable and destructive piece of business as this, with their eyes wide open, it is only fair and right that they should suffer the extreme penalty.—EDITOR.

SOME BRITISH COLUMBIA BUTCHERS.

My duties as deputy returning officer for the electoral district of Richmond, B.C., took me, during the recent elections, up Howe sound, a stretch of water some 40 miles long, running in from Georgia, at the head of which the Squamish river enters. At its entrance from the gulf the river is wide and dotted with many islands, some settled and more still covered with heavy forests.

The shores of all, as also those of the sound, are rocky and precipitous. The channels between the islands and between them and the mainland vary from a mile to several miles in width. Deer swim from one island to another or from the mainland to the islands or vice versa.

I had chartered a good sized naphtha launch and my father-in-law, Mr. Denmark, accompanied me on the trip. While passing up the channel between Gambier island and the mainland we saw a deer swimming with just its back and head above water. It was within 75 yards of shore and we put on all steam to head it off. We had no firearms and no rope but the anchor rope.

There happened to be a spare oar aboard, Mr. Denmark grabbed this and stationed himself in the bow to deal the deer a blow on the head as the boat passed. Mr. D. did not get in his work in good shape. The deer gained the shore and scrambled on a ledge of rock in the face of the cliff. Full speed astern soon took us

back to the place where the deer had landed and there, to our unbounded satisfaction, we found there was no way in which he could get out of his nook except by the way he went in. He backed into his corner and stood facing us about 30 feet away. Our rope was too short to lasso him and we dared not land and tackle him with the oar as he was a big buck and evidently meant business.

Suddenly the deer jumped for a small ledge higher up, missed his footing, and went headlong into the water again. That was our chance. We forced the boat in between him and the shore, dropped a noose of the anchor rope over his head and secured him. When we tried to haul him aboard he struggled furiously. We finally hauled his head over the side of the boat and cut his throat with a small pocket knife.

While resting after the capture we saw another deer swimming in mid channel. Having learned a thing or 2 while capturing the first, we knew how to go to work. We got our rope ready and steering alongside, quickly dropped our noose over the deer's head and despatched him in the same way as the first. They are both bucks in prime condition.

J. Burton, Steveston, B. C.

You are a disgrace to the Government that employs you. British Columbia is making or amending laws every year to protect its game, yet you, an employee of that Government, go out and butcher 2 deer in the most cold blooded, hideous, repulsive manner that could possibly be devised. You and your friend should go to Chicago or Kansas City and apply for work in a slaughter house. You would certainly be able to earn good wages there and could satiate your thirst for blood by butchering domestic animals which can be reproduced by the thousands each year. It would be much more manly and decent to hang up a steer by the heels and smash his skull with a sledge hammer than to rope a poor, defenceless deer that is swimming in the water, drag it aboard a launch and cut its throat. Your number in the game hog book is 958 and that of William Denmark is 959.—EDITOR.

A CALL TO OHIO SPORTSMEN.

The enclosed article from the Cincinnati Commercial Tribune of December 11, 1903, gives the sportsmen of this State warning to prepare for a fight.

The Ohio Hotel Men's Association, in convention, appointed a committee to work for the repeal of the Ohio game laws. The present State Legislature will be asked to carry out this proposition.

The hotel men state that the game laws are

absurd, hurtful to their business and of benefit only to the game warden. At the business meeting Nicholas A. Court, of Columbus, was elected President of the association.

Nobody knows better than you how difficult it is to get a good game law and one that will stand. The present law, which has stood the test of the supreme court, permits game to be in possession only during the time it may be hunted in this State (20 days), no matter where it came from, in or out of the State. Nobody but the hotel keepers and game dealers objects to this feature of the law. The sportsmen are satisfied to have and to hold for 20 days; but as the hotel men can not make enough money in so short a time to satisfy them, they will petition our Legislature to extend the season of possession; to allow them to handle, sell and serve game at any time in Ohio provided it comes from a State where it is legal at that time to kill game. The result would be that game would be on sale in Ohio during almost the entire year; also that game would be shot and snared in Ohio during the same period, as these sensitive citizens are not in business for their health, and would surely secure the quails with the least outlay of money, namely, at home.

All quails look practically alike to you and to me, and it would be distressing to see a post mortem held on a quail by a hotel man or game dealer on one side and a game warden on the other, to establish its residence previous to its death.

I understand the Ohio Game Dealers' Association is also interested with the hotel men in seeing that a long suffering traveling constituency is supplied with quail at so much per. The market and pot hunter has not openly appeared, although a shot in the direction of the surrounding brush would probably wing one.

It would scarcely be possible for dealers to secure game from beyond the State without encouraging somebody to violate the law, so stringent are the laws of all States in the matter of the shipping of game out of the State.

The arguments in favor of the present Ohio laws are so many and so forceful that it is unnecessary to refresh your or your readers' memory with a review of them; but the fact that a powerful opposition to these laws is in the field and prepared for work requires more than discussion and expressions of regret; it requires work, now, and continued until the battle is won or lost.

Let us all do our best to defeat this effort and at the same time save our game from constant harassing and total extermination. Please press the button and start the machinery.

F. G., Cincinnati, Ohio.

AS TO BRANDING OF GAME AND FISH HOGS.

I want to offer you a friendly suggestion. Your attacks on what you are pleased to term game hogs are, I think, frequently made in a way lowering to your dignity and to the dignity and effectiveness of RECREATION. You have a good magazine, and it is doing a great work, but I believe you would secure better results and greater support from the better class of readers if your onslaughts against game hogs were couched in more temperate language. I know you mean well, but you ride too rough shod.

W. H. Mullins, Salem, Ohio.

ANSWER.

I thank you for your frank letter. I always appreciate friendly criticisms of my work and you are not the first good friend who has given me the same advice. However, I can not agree with you as to my methods of hunting game hogs.

If you were to get into one of your ducking boats and go after a flock of geese, you would not use No. 12 shot. If you were going after grizzlies, you would not use a 22 caliber rifle. If you were going after Satan, you would not use a squirt gun.

When I talk to gentlemen I always try to use polite English, but when I talk to blackguards and ruffians, the kind of men who slaughter game, and then boast of it, and have themselves photographed with it, I use such language as seems necessary to penetrate their epidermis. These men are usually thick skinned, and it takes a sharp weapon to pierce them.

As you probably know, some of the other sportsmen's journals have been talking mildly and politely to such men 30 years, and not one of them has ever been reformed by it. On the contrary I have had letters from thousands of men saying they had never realized the enormity of their offences until I went after them with my branding iron. They say my words have cut deep, that they have now reformed, and that they now quit when they get enough. Furthermore, many of these reformed butchers are now counseling moderation and decency among their fellow men, in the matter of shooting and fishing.

It is impossible for any man to understand the many peculiar conditions that exist with regard to these matters, without being in such a position as I am in. You know how it strikes you and your friends, but you do not know how it strikes the men at whom it is aimed. Of course I have made enemies of thousands of these men, but I can afford to have their ill will. Many of them have, however, taken their medicine in good spirit and reformed. Meantime hundreds of thousands of other men and boys are fighting shy of my pig pen; and the game and fish are being saved.—EDITOR.

TWO NEW ANIMAL TRAPS.

No. 735,957. George F. Eberhard, San Francisco, Cal. Filed Oct. 9, 1902. Serial No. 126,561.

Claim.—The combination in an animal trap of wire bent on itself to form spring arms, the ends of these arms terminating

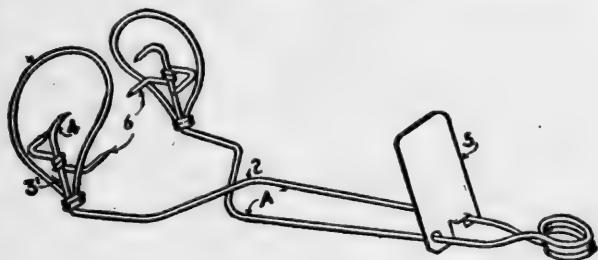

in oppositely curved jaws adapted to interlock, and provided with impaling teeth, of segmental shaped loops, on said arms inclosing and approximately in the same plane with said jaws, said loops adapted to interlock each other when the trap is sprung, and a trigger whereby said arms are held in a compressed position.

No. 729,786. Edward F. McDaniel, Otisco, Ind., assignor of one-half to Arnie C. Schlichter, Otisco, Ind. Filed Nov. 10, 1902. Serial No. 130,707.

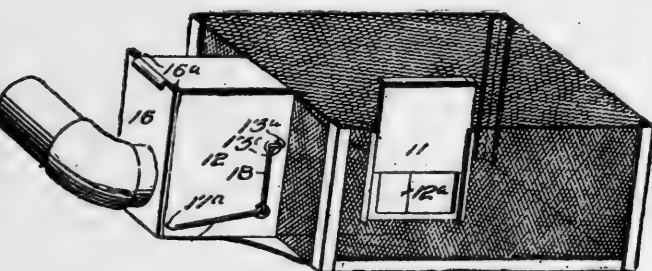

Claim.—An animal trap comprising a cage, an inwardly opening door leading to said cage, and means for attaching bait to the inner side of said door, whereby the animal can gain access to the bait only by operating the door and entering the cage.

WISCONSIN BUTCHERS.

November 20th, 1902, Leonard Morrison, a farmer living 15 miles South of Madison, Wis., was hauling corn to his cattle. While driving through a small wood lot he was astonished to see a 5-prong buck jump up and stand watching him. Morrison drove to his house, got his rifle, and with his brother-in-law set out after the deer. They tracked him across cornfields 2 miles to where he entered a patch of timber. Meanwhile another man had seen the buck enter the woods and pursued him with a shot gun; he jumped the buck and shot twice without effect. The 2 men who had rifles fired at

the deer as it was disappearing in another clump of woods. The buck went on and from the last reports he was headed West and still going, creating more excitement wherever he was seen than an old time Indian uprising. Where he came from is a mystery, as there have been no wild deer in this section for 35 or 40 years, and I know of no park in the vicinity from which he could have escaped.

Henri Leo, Madison, Wis.

Of course the deer must be hunted and killed. It would never occur to any of these men to let a live deer settle down and make his home among them. No; every farmer and every farmer's boy who could muster a gun of any kind must turn out, join the hunt, follow the poor creature and some of them would of course get a bullet or more likely a charge of buckshot into him. Then all the human hyenas would celebrate their victory.—EDITOR.

AN ATTRACTIVE GAME FIELD.

The altitude here is nearly 9,000 feet and the climate is temperate. All the Southern fruits and vegetables are grown here, including many of the sub-tropical varieties. From April till the first of July the weather is pleasant. The days are warm or hot, but the nights are cool. There has not been a night since I have been here when I did not need at least 2 blankets. The rains start in July and continue daily till the last of August. That is the most unpleasant part of the year. The days between 11 and 3 o'clock are warm during June and July, but the rest of the day is fine. The deer are poor and tough in spring, but bear and cats are in good condition. The bear are not fat, but their skins are all right for rugs.

Most people associate Mexico with hot weather, snakes, insects and all kindred pests, not to mention Indians and bad white men. There are no Indians in these parts, and bad men, snakes, insects and other pests are confined to the lowland regions, near the coast and to the South. This is a great country, and is fast becoming popular with sportsmen. An all the year season, no non-resident license laws and plenty of game make it attractive, not to mention the interesting Aztec ruins and the beautiful scenery.

J. H. White.
Colonia Pacheco, Chihuahau, Mex.

GAME NOTES.

Since writing you before, I have arrested 3 salesmen of wholesale millinery houses, who travel in this county. Two pleaded guilty and paid \$50 and costs each. The other called for a jury trial. As I have

never lost a case yet, and have evidence that will keep, without ice, I am not worrying about the outcome. Recently one of my deputies and I went out after 2 Italians. We drew a charge of shot from one of them; no damage done. They had 21 song and insectivorous birds. Cost them \$100 and costs. Since I have begun on the wholesale fellows, they are trying through the Wholesale Jobbers' Protective Association to make it uncomfortable for me. However, as long as I hold the commission, I shall continue, in a fair, conservative way, to enforce the laws, no matter how much money the lawbreakers may have. I have never discriminated between violators of the law.

G. H. Ray, Rock Creek, Ohio.

None of our sportsmen who went after prairie chickens at the opening of the season reported large bags. Those who went North into Wood and Adams counties say the marshes were so wet that the birds sought the brush on higher ground, making shooting difficult.

Our game wardens are busy patrolling the game regions with the view of strictly enforcing the laws. If they keep on as they have started, the prospects are good that there will be less violation of the game laws than ever before.

Clerk Goff, of Dane county, has issued over 1,300 hunting licenses, many being for non-residents.

Leo Bird, Madison, Wis.

Reading July RECREATION I learn that one Charles Gass, of Paoli, Indiana, and a friend unnamed, went on a wild turkey hunt in this State last Christmas, fired 4 loads of shot into a big gobbler and failed to get him. For the information of your other Indiana readers permit me to state that the pursuit, shooting or destruction of wild turkeys in this State is prohibited by statute which provides a penalty of \$50 and 30 days' imprisonment for a violation thereof. I hope Charles will observe this law a good deal better than he shoots.

James D. Ermston, Anderson, Ind.

Game hogs are thick here. I caught one July 3 with 2 little fawns in his possession. I arrested him and Justice Sandel, of Easton, fined him \$50 and costs. That was the first arrest made in this part of the country for violation of the game law. The other hogs are grunting a whole lot, but I'll get more of them before I am through.

J. C., Easton, Wash.

I am glad you soaked one of these fellows and trust you may be successful in getting the others in due course.—EDITOR.

Hunters pay no attention to the game laws in this county. Chickens were scarce because of wet weather during the hatching season. They have been slaughtered regardless of scarcity and close season. It makes me feel like going on a still hunt for some of the butchers and giving them a taste of their own medicine.

R. E. Daniels, Orrack, Minn.

That is just what sportsmen should do in all cases where pot hunters go out and kill off game before the open season.—EDITOR.

I read in August RECREATION an amusing article by Jean Allison, entitled "Give them Marlins." In it he says that when the party arrived at their hunting station they went to bed and dreamed of juicy buck steaks and liver. Did he ever eat a deer's liver? How many of your readers have eaten a deer's liver?

E. B. Brigham, M.D., Indianapolis, Ind.

Our game laws are strict, especially those for the protection of quail. We have a local law much more stringent than our State law. One man was fined \$45 for killing 3 quails out of season.

R. A. Thomas, Del Rio, Texas.

The shooting season opened on Cape Ann with slender bags of game. Shooters report few birds of any kind. Our mainstay is the coot, of which there seems the usual flight.

B. F. Batchelder, Rockport, Mass.

Deer are plentiful in this vicinity, with bear enough to make it interesting. We have a few ducks, snipe and plover. Grouse are scarce.

R. M. Shutts,
Upper Chateaugay Lake, N. Y.

Deer, turkeys and quails are numerous here.

B. D. Harris, Quitsna, N. C.

Never shoot until you have a fair chance of killing.

First Missionary: Well, brother, how did you get on in your field? Did you convert many heathens?

Second Missionary: Yes, but just as I made converts of them, they all became hopeless drunkards.—Life.

He: Was that you I kissed in the conservatory last night?

"About what time was it?"—Life.

FISH AND FISHING.

NOTES OF A RUSSIAN ANGLER.

BARON PAUL TCHERKASSOV.

The following notes have accumulated during more than 30 years' experience as an angler and amateur tackle maker.

Notwithstanding the great improvements in rod making in the last 25 years, there are some points about the average rod of the present day which are not altogether satisfactory. The first of these is the manner in which ferrules are secured to the joints. This is done by means of pins, which, in the majority of rods, are

that sickness without having to send it to the rod maker, all pins ought to be put through so as to enable one to push them out when necessary, with the assistance of the simplest tools; a piece of knitting needle and something like a hammer. This is important, as it is unpleasant and difficult to worm out a ferrule pin in order to tighten the ferrule itself.

Elastic rubber cement, melting at a low heat, ought to be used for fixing the ferrules on to the wood. The cements used formerly to secure the solid rubber tires to

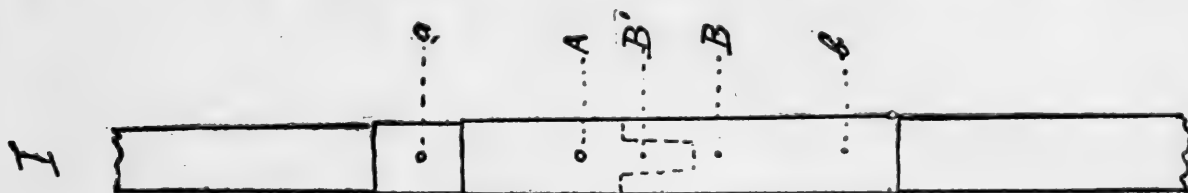

in the wrong places; too high in the male, or counter ferrule, and too low in the female ferrule; i. e., in both cases, too near the rim of the ferrule where it overlaps the wood. The result is that the wood is weakened at the point where it is subjected to the greatest strain, its elasticity being interrupted by the rigid metal ferrule; and if there is a smash, it is bound to occur just at that point. A further source of weakness lies in the exaggerated length of tenons, tongues, or dowels, with corresponding depth of sockets for them. In the accompanying tracing (I) *a-b* indicates

the metal rims of cycles ought to fill the bill exactly. The cement I have used consists of gutta percha, such as used in the manufacture of artificial baits, with or without the addition of powdered shellac.

I have lately come into possession of a 14 foot split cane grilse rod in which the position of the through pins in the male ferrules corresponds exactly with the position shown in the accompanying tracing.

Then there is the old question of flush versus dowelled joints. I decidedly prefer the former, and never have had the slightest difficulty in getting a perfect,

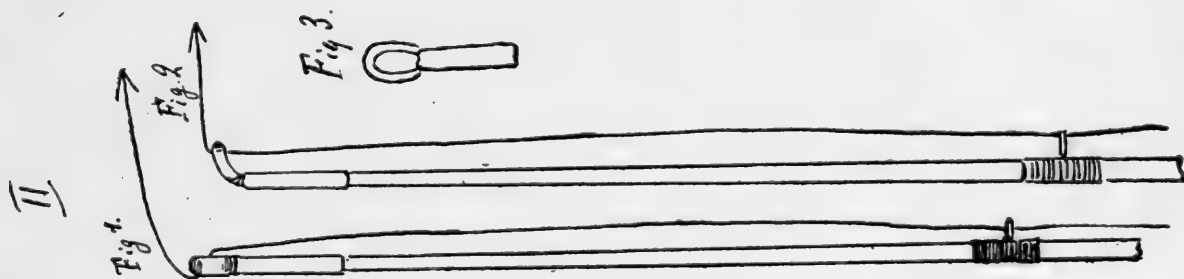

the usual position of the pins in the average rod, while *A-B* shows the position in which they would prove just as efficient and much less objectionable. In rods with flush ferrules, without tenons or dowels, the pin of the female ferrule could be shifted higher still, to the position indicated by *B'*.

Taking into consideration that all materials, except steel, used in the construction of rods, shrink under the action of dry air, that a ferrule-sick rod is an abomination, and that it is important to make it possible for the angler to cure his rod of

smooth, suction fit with them, making all kinds of locking devices superfluous. If there is such a demand for dowelled joints as to compel the makers to continue their manufacture, the length of the dowel or tenon ought to be reduced. The following ratio is satisfactory: length of dowel stands to length of that part of male ferrule which engages with female ferrule as 1 to 3.

In England of late years, the loose rings and keepers, which were formerly considered best for fly rods, whether intended for trout or for salmon, have been sup-

planted by light standing guides. Snake shape seems the most popular, though it undoubtedly has some disadvantages. In American fly rods the old loose ring still appears. The worst part of the ringing of the American fly rod is the end ring, which I have had to alter in all my own rods, as well as in those of my friends. The fly rod is used rings downward, in casting as well as in playing a fish, by the great majority of anglers. Under these conditions the one ring arrangement, as it appears on nearly all American fly rods which I have handled, is not satisfactory, causing an undue amount of friction. The accompanying tracing will help me to illustrate my meaning (II, Figs. 1, 2, and 3). Fig. 1 shows the way in which the line is twisted when working through the one ring tip as it is sent out, and Figs. 2 and 3 show the alteration made by me; Fig. 3 showing shape given to ring previous to bending it as shown in Fig. 2. It is a trifling one, and can be effected in a minute with a pair of ordinary pliers; but the advantages gained by it are not trifling, as anyone may ascertain for himself.

The grip pieces, or handles, of split cane rods are often put on to the lower joint without sufficient care. Several cases have come under my observation where the end of the lower joint was let into the handle $1\frac{1}{2}$ inches, with the natural result of breakage in that place. Breakages of that kind affect the reputation of the article and of its makers.

I remember when eyed hooks of the improved modern patterns were introduced, the brilliant future prognosticated for them. Many of the authorities on this branch of angling held that the fly on eyed hook was sure to supplant altogether the fly on snelled hook, but this expectation has not been realized.

The absence of space between the head of the fly and the eye of the hook is a serious defect. I found it finical work to tie the flies on to the gut in many cases. I have experimented, since then, with flies tied with a free space, 1-32 to 1-16 of an inch, between the head of the fly and the eye of the hook, and find that they are much more easily and conveniently tied to the gut, while not in any way more clumsy in appearance. For large bass, grilse and salmon flies I recommend return, or loop-eyed, hooks, in which the end of the shank, after having formed the eye, is laid back along the shank of the hook, toward the bend.

There is another item about eyed hooks which I do not find satisfactory. The eye is somewhat small, especially in the larger hooks. It might be made larger, so as to accommodate even a twisted gut snell, without in any way making it heavier or more clumsy, by reducing correspondingly

that part of the shank which forms the loop and the returned end of the shank.

Rust proof or brown enameled hooks are less obtrusive than the japanned ones. I strongly recommend rust proofing for double and treble hooks to be kept in stock. It may increase their cost, but will certainly save more in the long run.

THE KILLIE AS A BAIT FISH.

I am told that a few years ago one could buy what were called salt water minnows in cities on the sea coast. These could be packed in sea weed or moss and expressed to any part of the country. They could be carried in the pocket, apparently dead, but when put on a hook and dropped into the water would hustle away just like a fresh water minnow. Are there such fish and can they be bought now? If so, of whom?

C. J. Brower, Poughkeepsie, N. Y.

ANSWER.

The salt water minnow, or killie, is extremely tenacious of life, and bears absence from water wonderfully well. Under favorable conditions it is possible to keep killies alive in an ordinary box for hours. If they are packed carefully in wet sea weed they can be transported with ease and may reasonably be expected to remain alive 36 hours and possibly longer.

The packing of killies for shipment must, however, be done by an expert if this result is to be achieved. In the first place, the bottle green killies should be selected in preference. There is a common striped killie known variously as night killie and bass killie, that is absolutely worthless; it dies within a few hours after being caught.

Only the most lively killies should be used for shipment. The best weed for packing them is the ulva, or sea lettuce, and the pieces that are used must be bright green and living. If poor weed is used it will die and decay, killing the fish instead of preserving them.

Great care must be taken not to pack tightly. A flat tray is best, if it can be handled by the transportation company. The weed must be thrown in loosely, and in such a manner that each killie is separated from the rest. If the packing is at all tight, the wet weed will heat and kill the fish. If a flat tray is too clumsy for shipment, a basket of open wicker work will prove the best receptacle.

No salt water minnows could be carried around in the pocket and survive such treatment. The angler must carry them in a bait pail like fresh water minnows and treat them with as much care.

These salt water killies will live for weeks in small pools of fresh water and be as hardy when taken out as they were on the day of their capture. In ordering, lay stress on the fact that the killies wanted are

the bottle green ones with white bellies. Captain De Nyse, Bath Beach, Long Island, can probably supply them.—EDITOR.

SLAUGHTER NOT JUSTIFIED.

G. C. Gridley returned home yesterday from Du Rivier, in the Nippissing district in Canada, where he has been trout fishing a week or more. He caught an abundance of fish, sending out about 200 pounds and bringing 100 pounds with him.—Utica, N. Y., Observer.

Regarding this report Mr. Gridley writes:

Whoever informed you of the number of pounds of trout recently caught by me in a week rather exaggerated it. Six or 7 of us went into a club preserve about 180 miles North of Ottawa, on the Canadian Pacific Railroad, crossing the Ottawa river at Deux Rivieres, and the entire party estimated that our catch during the 8 days would amount to nearly 400 pounds. We had to confine our fishing to about 2 hours each day, as we caught more trout than we knew what to do with. We sent them liberally to our friends and the club.

G. C. Gridley, Watertown, N. Y.

Well, what if it is a private preserve? Why slaughter fish, even if you do have the opportunity and own the land? That does not justify you in committing a slaughter of fine game fishes. You and your friends could not have eaten 25 per cent. of the trout you say you caught in the time you were there. You may have shipped all the others home, but as the trout season comes only in the hot weather, the chances are that a large number of those fish spoiled and were thrown away. You seem to have been fishing for a record. This ambition that haunts many men to make big records, go home and tell the local editor about it and get their names in the paper is one of the causes of the trout streams all over the country having been cleaned out. If a man wants good trout fishing he must now go to Canada for it. That is probably the reason you and your friends bought or leased that land in Canada, and if you keep up the pace you have already started, you will soon clean that out, too.—EDITOR.

PRISON TOO GOOD FOR THEM.

Glen Morse, clerk of the Circuit Court of Outagamie county, Wis., and 5 or 6 other men were fishing in Evergreen brook, Shawano county, and caught 1,200 trout, ranging from 6 ounces to 2½ pounds each, so these men told me, in 4 days' fishing. Don't you think they got more than their share? You might write Glen Morse or George Ames, of this city, for verification of this story.

F. U. R., Appleton, Wis.

I wrote as suggested and Mr. Ames replied:

I was trout fishing with a party of 7 on the Evergreen river, 20 miles North of Shawano. We fished 3 days and caught 1,258 trout. Of that number about 125 weighed a pound each and some a few ounces over a pound.

George E. Ames, Appleton, Wis.

It is a constant source of wonder to me that decent, law-abiding sportsmen allow such swine as you and your friends to raid their streams and clean them out every year. I wish you had run up against a bunch of farmers like those in Illinois, who turned out, burned the tents and the camp outfits of a lot of fish hogs who were raiding one of their lakes, and then ran the aforesaid out of the country. An ordinary prison is too good for any such outfit as you and your pals. You should be locked in a box car and dumped into the Milwaukee river. Your number in the fish hog register is 960; Glen Morse's is 961, and if I knew the name of the swine who were with you, I would gladly label them also.—EDITOR.

MAY BE A FISH LIE.

While in our county seat the other day I met several local sportsmen. They seemed to have done more hunting and fishing than most business men find time for and I was impressed with their stories. One of them may be of interest to the readers of RECREATION.

Some time in June, 4 of the fellows, Frank Treat, Walter Hanscom and Lester Price, of San Andreas, and Alex. Smyth, of West Point, went to Blue creek on a fishing trip. Blue creek is one of the best trout streams in the Sierra Nevada; not only is it full of fish, but they are of good size.

The fishing was good from the start, and as the boys are all experts they had no trouble in catching all the fish they could use. The day before their return, as each had a circle of friends hungry for trout, they determined to get fish enough for everybody.

It must have been a great day, because at night 4 tired fishermen counted out 600 trout, of an average size of 10 inches. When the townspeople saw this immense catch and were told it had been made in a day, many were incredulous, and openly accused the boys of netting the fish or of killing them with dynamite. When shown the hook marks in every fish, their doubts vanished, and they could but congratulate the lucky ones.

E. B. Schaiffle, Valley Springs, Cal.

If this story is true, these 4 men deserve to be sent to jail for at least 6 months each.—EDITOR.

UNSPORTSMANLIKE.

The fishing party that went up to Big Bend caught 150 bass, 14 catfish, and one eel. The party was composed of Jim Mitchell, Tom Sharp, Emmet Whorley, Bill Maupin and Alphonse Epler. They are much elated over the catch.—Hinton, W. V., Mail.

To my inquiry regarding the truth of this report I received the following reply:

Four friends and I went on a fishing trip around Big Bend tunnel and were gone 4 days. Two of these days the water was too muddy for us to fish. We only fished 4 hours the first day and 7 hours the last day. We caught about 100 bass, and a few catfish on trot lines at night. We used live minnows for bait and fished 15 miles of Greenbrier river.

W. R. Maupin, Hinton, W. Va.

It does not appear that you and your friends caught more than a reasonable number of fish, but you should all be heartily ashamed of the manner in which you took them. No real sportsman ever uses a trot line in these days. Neither does he set his rod over night. He fishes only in daylight, with a rod and line, and if he can not get fish in that way, he lets them stay in the water until some other time.—EDITOR.

MR. FEE PLEASE NOTE.

David Cotton and Daniel Roy, in the employ of the Northern Pacific Railway, went to Battle lake Sunday on a fishing trip. They caught 138 pike within 2 hours.—St. Paul Dispatch.

Concerning this Mr. Roy writes:

You have been correctly informed as to the number of fish caught and the length of time consumed in catching them by Mr. David Cotton and me in Otter Tail lake, near Battle lake, Minnesota.

Daniel Roy,
Northern Pacific Railway Co., St. Paul,
Minn.

It is fair to assume that the fish would average 2 pounds each and that you caught in all 278 pounds of pike in 2 hours. Truly you have earned a place in RECREATION'S fish hog pen and you shall have it.

Your brands read as follows: Daniel Roy, No. 962; David Cotton, No. 963.

Mr. Fee, General Passenger Agent of your road, is a firm friend of the cause of game and fish protection, and I trust that when he reads this he will give you a month off in midwinter, in order that you may have plenty of time to think over your cussedness.—EDITOR.

A SWINISH GUIDE.

George W. Butler is satisfied that Nova Scotia is good enough for him at present. He with his brother, T. V. Butler, and James Goucher are trying to rid the streams of this country of trout, having caught 103 in an afternoon. Later they

caught 180 in one day's fishing.—Yarmouth, N. S., Light.

I wrote Butler, asking if this was true, and he replied:

The report is perfectly true.

S. V. Butler, Hebron, N. S.

It appears from portions of Butler's letter which I have not printed that he poses as a guide, and, like many others of his calling, he believes in making all he can out of the trout streams to-day, letting tomorrow take care of itself. At the rate at which he and his companions are hooking the trout, the supply will soon be exhausted. It may as well be so, for men of such swinish proclivities should be compelled to earn their living by plowing, digging potatoes or some other equally hard work. S. V. Butler's number in the fish hog book is 964; George W. Butler's is 965, and James Goucher's is 966.—EDITOR.

ALL THEY WANTED.

The enclosed clipping is from the White Hall, Ill., Register. What is the use of the Government's distributing game fishes as long as such brutes are running at large.

Fishing in White Hall, Ill., West of Pogram, has been excellent. F. M. Mytinger and J. E. Wyatt caught about 100 black bass, weighing a pound to a pound and a half.

Mytinger's confession is:

Mr. John Wyatt and I caught 100 black bass in 3 hours. We could have taken as many more, but we had all the bass we wanted for ourselves and friends.

F. M. Mytinger, White Hall, Ill.

I am surprised at your statement that you had all the bass you wanted. Men with such bristles as you and your friend seem to wear rarely quit until compelled by darkness, or the exhaustion of the supply, or some similar condition. Any gentleman who goes after bass quits when he gets 10 or 15, but it seems to require about 50 to satisfy you and the other chap.

Your number in the fish hog book is 967, and John Wyatt's is 968.—EDITOR.

DYNAMITER FINED.

Sunday, June 21, a gang of Italians was discovered dynamiting fish in Big Sandy creek. Marshal Gruber was informed and went for them. He succeeded in getting 5. Mayor Stands called on them for \$25 and costs a man, or \$148 for the bunch. They paid the fine. It was a good haul for Sunday, but the wish is generally expressed that the whole gang, about a dozen, had been caught and fined \$50 each. We once had good black bass fishing here and many a fine catch I have made, but dynamite has been getting in its deadly work for several years and, I am sorry to say, with no loss of life, except to the fish.

Sandy, Waynesburg, O.

GUNS AND AMMUNITION.

Anybody can shoot all day, but a gentleman always quits when he gets enough.

THEY WRITE WINCHESTER.

Chicago, Ill.

The Winchester Repeating Arms Co.,

Dear Sirs—I have before me a copy of November RECREATION, which I regard as a real sportsmen's magazine and good authority regarding our outdoor life. In it I see an article about automatic shot guns which interests me much. I am a true lover of nature, American wild animals and game birds, and I enjoy seeking the wild creatures in their native haunts. I regret to learn that you contemplate making a shot gun which will discharge 6 shells in 2 seconds. You will agree with me that there are already too many game hogs at large slaughtering birds and game with the shot guns of the present day, and should an automatic gun be put on the market, it would mean that the birds and game will soon disappear as the buffalo has gone. For instance, a game hog encounters a covey of quail; if he gets a pot shot that means a decrease of about half their number. When they rise he has 5 shells left, and will clean out the whole covey, as most of these fellows are good shots and go for the game, not the sport. With a double barrel gun the birds have a show.

This is a suggestion to protect our game. I shall do all in my power to discourage the use of an automatic shot gun among my many field friends. That such a gun is not intended for real sportsmen is recognized by all.

Mr. Shields has the right idea regarding automatic shot guns, and may success follow him in his endeavor to protect our American game.

An automatic gun may be more modern in construction than others and perhaps equally as powerful, but just place a fire arm of this nature in the hands of a game hog and all the game laws in the Union will be of little use. I sincerely hope that this gun will not be manufactured, but that you will see this important fact before it is too late, as I think there must be a few sportsmen in your company.

Truly yours,

A. S. Miller.

Hampton, Va.

The Winchester Repeating Arms Co.,

Dear Sirs—I call your attention to an editorial in RECREATION for November regarding the manufacture of automatic shot guns. I wish to go on record as endorsing everything contained in that article, and sincerely trust that you are not

contemplating the manufacture of any such gun, which you would never sell to decent sportsmen. Only the lowest class of pot hunters would use such a weapon, and as a rapid exterminator of game it would surpass anything ever known. This, it appears to me, would in the long run injure your business greatly, for if there is no game what chance have you of disposing of shot guns? A man has no use for a mousetrap after the mice are all caught. I have always entertained the highest regard both for your firm and the goods you manufacture, and each year use numbers of your shells; but should you make the mistake of putting such a weapon as an automatic shot gun on the market I should not only condemn it in the strongest terms, but should never again use anything made by you. I believe you would be made the subject of the most scathing condemnation by the L. A. S. and by all who deserve the name of sportsmen. You surely wish to cater to the majority, and the feeling in regard to game protection is growing rapidly. If you have had any serious intention of manufacturing this arm you will do well to abandon it.

Yours truly,

Chas. H. Bentley, L. A. S., 3619.

New Market, N. J.

Winchester Repeating Arms Co.,

Dear Sirs—I have noticed recently that you are about to place on the market a new Winchester gun, an automatic weapon, calculated to be more destructive than anything now in general use, and I write you to protest against this gun. My individual protest may not carry any weight with you, but you should and probably do know that the sentiments expressed in this letter are the sentiments of every real sportsman in the country.

It is a notable fact that the game of this country is fast being killed off, and any invention that tends to destroy game more rapidly is nothing short of a public calamity. The guns of the Winchester Arms Company are sold almost exclusively to hunters, and you should be able to see that if this new gun of yours gets in the hands of pot hunters it will only be a few years until there will be no sale for your guns of any description.

As I have owned and sworn by Winchester rifles and ammunition for the past 10 years, I feel fully justified in making this protest, and sincerely hope you will not cause your admirers and customers to

blush for you because of your lack of regard for our animal and bird life.

Truly yours,
Joseph E. Kelly.

Richmond, Va.

The Winchester Arms Company,

Dear Sirs—The members of our gun club having read in RECREATION a statement to the effect that you intend to put on the market an automatic gun, have instructed me to write you and ask you not to do so. I am also instructed to advise you that they will do all in their power to discourage the sale and use of such a gun. Hoping you may decide not to manufacture any such gun, I am, yours respectfully,

J. H. Pugh.

DEFENDS THE SMOKELESS.

I noticed in RECREATION an article by E. H. Kern, wherein he condemns the smokeless rifle for its wounding of game, and mentions 500 yards as being as far as one can kill deer except by chance. Not more than one man in 10 who goes to Colorado to hunt can guess the distance, and hit one deer in 3 shots at 500 yards. Were it possible to enforce such a law, there should be a fine imposed on any man who shot at deer at any such distance, unless it might be an animal that had been wounded at a shorter range. It is not necessary to try long shots in the country North of Rifle. I have hunted there and found no trouble in getting short shots.

Mr. Kern says 50 does are killed to one buck; that nearly every deer killed bears marks of previous wounds; and that more deer are crippled with smokeless powder than are killed. What particular mark does smokeless powder make, that he can distinguish it from a black powder wound?

He also mentions the crippled and dead deer he saw North of Rifle. There never has been and never will be a gun that cripples no game, unless built on the Marlin line, for any gun that shoots may be misaimed. Still, if long guesswork shots were stopped it would prevent much crippling.

In all my hunting in Colorado I did not see one dead deer that had been wounded and got away to die. I like smokeless powder, for I wish to see if I hit a deer and not have to wait for the clouds to roll away.

The law of Colorado was much improved last winter in making the open deer season September 15 to September 30, and in limiting each hunter to one deer and that a buck. I can easily see how that buck clause might mean a dead deer left to rot.

Anyone not used to hunting big game might kill a doe in cover, mistaking it for a buck. In that case, as the law stands now, the doe would probably be left to rot where it fell.

I think too much is expected of the game wardens. The hills were full of hunters and if there were wardens enough to see that the law was lived up to in every case, the woods would be so full of men that game would go to the open country.

Smokeless guns heretofore have been too light in weight and too small in bore. The last objection has been met to a great extent in the new 35 and 38. Like T. S. Van Dyke, I prefer a deer killed stone dead by a 3 or 4 inch wound, to a deer that gets away and dies a slow death from a wound that might have been made with a fence wire. I have had no trouble with deer getting away, but last fall I lost a silvertip that perhaps would have remained down had I used the 35 instead of the .303.

Stubb, Orwell, Ohio.

RESULTS WITH A 50 CALIBER.

I have been an enthusiastic reader of RECREATION over 5 years. Guns and ammunition have my first attention and I can neither eat nor do anything else until I have absorbed all that department contains. I am in accord with the policy of roasting game hogs and will help all I may.

On the subject of the best all around rifle I must say a word. At the risk of being called an old fossil I will say my favorites are 50 calibers. I have owned a 23 Remington-Lee, a 30-40 Winchester, a 30-40 Marlin, a 303 Savage, a 25-36 and several other high power guns. Their chief points of excellence seem to be the power to kill a squirrel without tearing or kill a bear instantly; also to shoot less than 300 yards or more than 3 miles simply by using different ammunition.

All this I find can be done with the 50 as well or better. I give results which can be proven:

Gun, an old style Sharps carbine; shell loaded with a hollow base ball with a bearing of $\frac{3}{8}$ inch and weighing 97 grains; powder, 7 grains Gold Dust shot gun. At 200 yards this load put 10 shots in a $2\frac{1}{2}$ inch circle, and with it I have killed squirrels without mangling; 200 yard trajectory, 7.31 inches at 100 yards.

Gun, 50-110 Winchester single shot; shell loaded with 215 grains hollow base ball; 30 grains Gold Dust powder; 300 yard trajectory, 23.75 inches at 150 yards.

Same gun: shell loaded with 450 grain ball and 50 grains powder gave a penetration of 31 inches in pine boards, and I have shot with it through a telephone pole 17 inches in diameter. This caliber, especially

if using a hollow point ball, would not be likely to let a deer or even a bear run far.

When an amateur attempts reloading he should know about dense and bulk powders, and the initial or breech pressure difference between nitro and picric acid powders. I think it would be an excellent thing if everyone reloaded his shells, but until the average shooter learns these points it would be folly for him to do so.

Reloader, Batavia, N. Y.

RECREATION FAIR.

Regarding your editorial remarks in December, 1902, RECREATION, I read the article you mention and received the impression that you intended to pay the Winchester people a compliment by conveying the idea that, in view of the character of RECREATION and the fair play observed toward all parties, they would not be so narrow as to take offense and withdraw their ad in consequence of such an article. A re-reading of the article does not alter my impression.

As to the criticism that the Gun and Ammunition department of RECREATION is "comparatively obscure," it seems that the contrary is true, at least so far as rifle, revolver and shot gun shooters are concerned. Neither can I see anything unfair in submitting questions which arise concerning guns or ammunition to acknowledged experts on those subjects.

As to the Winchester people having good reason for withdrawing their advertising from RECREATION from anything that has appeared in its pages, I do not think such grounds exist. I have always been proud of such splendid companies as the Winchester and the U. M. C., and have used a great deal of ammunition, and I confess to considerable disappointment at missing their reading matter in the only sportsmen's magazine which I see regularly. Nothing that has been printed in RECREATION has influenced me against their goods, although as an ardent advocate of greater game protection, I do share some of the opinions which have been expressed concerning the pump gun, no matter by whom manufactured. These views are in no way due to anything that has appeared in RECREATION or any other magazine. It would seem that a sportsmen's magazine which permits the honest criticism of its readers to be published must expect to get along without the support of the gun and ammunition makers.

Howard W. Carter, Norfolk, Conn.

ANSWER STANLEY WATERLOO.

In reply to Stanley Waterloo's letter in September RECREATION I tender my mite of advice. Living in New York City and fi-

nancially unable to go on any kind of a hunting trip, I do the next best thing. There is a 100-yard range near my home where I shoot every Sunday, and where I meet all kinds of cranks. I was surprised one day to see a man there using a telescope sight. It seems he had lost the use of one eye. After studying catalogues and having different rifles made, he settled on this gun I saw him use, which he says completely meets his requirements. The drop of the stock is 4 inches and the telescope is a Malcolm with side mountings. The glass is the wide angle pattern of 2 power. I think such an outfit as this would be just what Mr. Waterloo wants, as it brings the eyes in natural position for shooting.

I use a 22-7-45 for all shooting up to 200 yards. A more accurate little rifle is hard to imagine.

Is there any way of letting the hammer of a Savage down without discharging the gun, so that the action may be opened?

I should like to hear from some readers of RECREATION who are interested in target shooting for the sport there is in it and who live near New York.

Wm. J. Marshall, New York.

The inquiry made by Stanley Waterloo, who wished suggestions as to how to shoot well when deprived of the use of his right eye, reminds me of Captain Robert, a retired French officer, who formerly lived here. The Captain had lost his right eye, and had had a special stock made for his gun, with a proper twist known to gun makers, which brought the barrels easily in line with his left eye, enabling him to shoot with remarkable speed and accuracy.

Joel Doux, Utica, N. Y.

PETERS CARTRIDGES CALLED IN.

HEADQUARTERS,

DIVISION OF THE PHILIPPINES.

MANILA, P. I., November 11, 1903.

Circular No. 49.

The following is published for the information and guidance of all concerned:

"WAR DEPARTMENT,

"ADJUTANT-GENERAL'S OFFICE,

"WASHINGTON, October 2, 1903.

"The Commanding General,

"Division of the Philippines,

"Manila, P. I.

"SIR: The Chief of Staff having been advised by the Chief of Ordnance that the calibre .38 revolver cartridges manufactured by the Peters Cartridge Company are loaded with black powder which has deteriorated since its purchase, he directs that all Post Commanders in your Department be required to turn in all such ammunition to the nearest arsenal, reporting date of

shipment promptly to the Chief of Ordnance of the Army.

"Very respectfully,
"W. P. HALL,
"Acting Adjutant-General."

In the Division of the Philippines the defective ammunition will be turned in to the Manila Ordnance Depot and the reports of shipment sent through the Chief Ordnance Officer of the Division.

By Command of Major-General Wade.
W. A. SIMPSON,
Colonel and Assistant Adjutant-General,

GAS OPERATED FIREARM.

735,131. Gas Operated Firearm. Samuel N. McClean, Washington, Iowa. Filed Jan. 20, 1898. Serial No. 667,361.

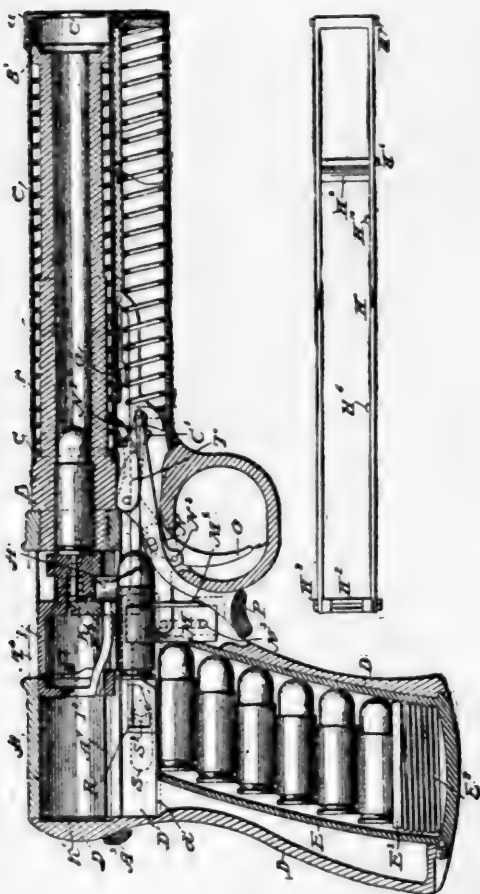

Claim.—In a breech loading gun, the combination of a barrel and a receiver, with a reciprocatory and rotary breech block, a slide operatively engaging said block to reciprocate and rotate said block to lock and unlock it, and means actuated by the gases of explosion and imparting movement to said slide, etc.

ANSWERING HENRY WIGGIN.

I have had a 25-20 carbine, and have used it constantly more than a year with no trouble whatever. I made over the carbine

stock and put on a Swiss plate, removed carbine rear sight and put on a Lyman No. 2 with cup, also removed carbine front sight and put on a windgauge, with aperture pinched and ivory bead. I cut off forearm and magazine; took off the strap holding magazine and fastened it to the barrel with a dowel. Have eased up trigger pull to about $\frac{3}{4}$ pound. This made considerable slashing, but the result obtained is gratifying.

I have used this gun for woodchucks, and had no trouble getting them, within reasonable range. Have also shot it over 200 yard range, loading bullet in barrel separately, using 22 or 23 grains semi-smokeless, with 75 or 86 grain bullet, with good results, taking into consideration that it is a light weight gun and not a target rifle.

For a gallery load I use $1\frac{1}{2}$, 3 or 4 grains Laflin & Rand Infallible, with 65, 75 or 86 grain bullet, preferably 75 grain, made fairly hard. This powder should be weighed, as a slight variation will raise or lower the bullet accordingly. I also use nitro primer and crimp bullet well in shell.

Altogether it makes a fine all around gun and a good caliber to experiment with.

H. B. Johnson, Syracuse, N. Y.

ADJUSTABLE GUN STOCK.

729,030. Adjustable Gun Stock. Joe C. Yount, Thayer, Iowa. Filed Jan. 9, 1903. Serial No. 138,374. (No model.)

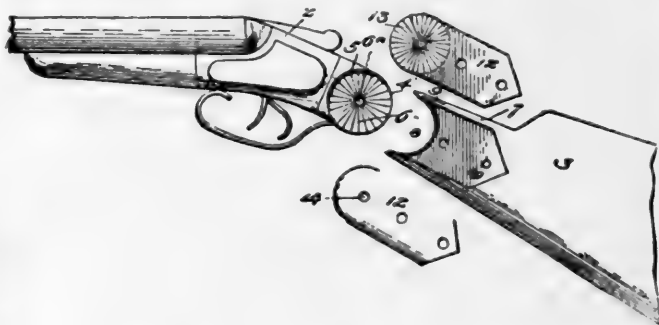

Claim.—In a gun, the combination with the stock having a semicircular concavity in its outer end, of a lock chamber having a semicircular shaped end adapted to engage the semicircular concavity in the end of said stock, circular depressions formed in the sides of the end of said lock chamber, plates having one end fixed to said stock, their opposite ends being adapted to engage the circular depressions formed in said lock chamber, serrations formed in the faces of said depressions and similar serrations formed on the contiguous faces of said plates, whereby said parts are prevented from slipping, and means for clamping said plates in said depressions.

SMALL SHOT.

I greatly enjoy the friendly discussions in RECREATION'S gun and ammunition department. To discuss a subject with a view to bringing up new points or studying details is a good and practical way to diffuse knowledge. The way Dr. J. A. Elliott, of Northumberland, Pa., has of settling some of the mooted questions is the most scientific. His report is clear, decisive and I believe unprejudiced; and is the only one that has completely satisfied me on just those points I wished to know. Such efforts should be encouraged and should be accepted without debate. If there were more of such investigations and less natural gas explosions on other debatable questions, we should arrive at perfection much sooner. It has a discouraging effect on scientific investigators to receive idle, baseless criticism when they have given their time, talent, money and reputation to learn facts. I long to see more investigators and demonstrators, and a higher standard of sportsmanship.

Geo. M. Clouse, M. D., Columbus, O.

Please give dimensions of the German ring target. Does it differ from the target used by the American rifle team?

O. J. Axtell, Hambleville, N. Y.

ANSWER.

The dimensions of the German ring target are as follows: Diameter of bulls eye 12 inches, embracing the 18 ring; highest circle of count, 25, 1½ inches diameter in center of bulls eye. Concentric circles ¾ inch apart counting from 25 down to 1. This target is used for offhand 200 yard shooting.

The military targets, such as used by the U. S. Army and Militia in the international contests, are as follows: Third class for 200 and 300 yard shooting; Outside dimensions, 4x6 feet, bulls eye 8 inches, counting 5. Second class target for 500 and 600 yard shooting; Outside dimensions, 6x6 feet, bulls eye 22 inches in diameter, counting 5. First class: Outside dimensions 6x12 feet for 800, 900 and 1,000 yard shooting; bulls eye 36 inches in diameter, counting 5.—EDITOR.

Will some one interested in revolver shooting tell me of some brand of clean smokeless powder that will give good results in a 44 cartridge?

L. H. L., Hackberry, Kans.

ANSWER.

Good results are obtained with the Hazard smokeless rifle powder No. 2. In using this powder the same charge cup as is used for black powder will give the proper quantities,

that is, using the same bulk. The shells should be well crimped on the bullets to get good results. This will involve opening the mouth of the shells each time they are reloaded. The Ideal reloading tool is suitable for this work. Good results can also be obtained with Laflin & Rand Bulls-eye powder, using a shell with a crease near the mouth to prevent the bullet from slipping too far into the shell. The proper charge of this powder for the regulation 44 is 3½ grains by weight. The shells should also be crimped when using this powder.—EDITOR.

Will a shot gun with a 40 inch barrel shoot farther than one of 32 inches? Has the larger barrel any advantage?

Adrian Valdos, Ambler, Pa.

ANSWER.

There is no advantage in any shot gun having a 40 inch barrel. By common consent large gauges are made with longer barrels than smaller ones. Guns of 28, 24 and 20 gauges are best 26 to 28 inches long; 16 and 14 gauge, about 28 inches; 12 gauge, either 28 or 30 inches. Some 12 gauge brush guns are built with 26 inch barrels, and when properly bored give surprisingly good patterns. Ten and 8 gauge seem preferable in 32 to 36 inch barrels. Assuming that all barrels must be long enough to properly consume the powder gases, the quantity of metal in the barrel and its distribution, coupled with the method of boring, have much more to do with the efficiency of the gun than the length of barrel has.—EDITOR.

Four years ago I was on a bridge over the middle branch of Root river in this State. The bridge is 22 feet above the water. I was shooting suckers with a 38 caliber. A water snake about 4 feet long came swimming up stream; when he was about 20 feet above the bridge I lined up on his neck and cut loose. To my utter astonishment, considerable water flew 10 or 15 feet above the bridge and with it came the snake's head, cut off as clean as with an axe. The water was about 12 inches deep, with solid rock bottom. Can any one explain what brought the snake's head up there? I use a 22-7½-45 and think it far superior to the common 22. I have just seen the first 22 Savage rifle that has been brought here. It is the neatest arm of that caliber on the market. Marlin is now beaten on the only gun he had on the market that was any good, namely his 22 caliber.

W. S. Jones, Albert Lea, Minn.

The Grand Haven Gun Club was organized in this city September 10th, 1903,

and has since built a comfortable and commodious club house on the banks of Stearns bayou, in Robinson township, 5 miles from Grand Haven. The officers of the club are, Conrad Vanden Bosch, President; Wm. Pelleyrom, Vice-President; William Thielman, Secretary and Treasurer; Peter Wieringer, Martin Vanden Bosch, and Henry Hubert, Directors.

We have, adjacent to the club house, a large tract of open ground, which is shaded by several large trees, and which we shall use for trap shooting. We already have 20 members and hope to add largely to the number in the near future. Nearly all our members are regular readers of RECREATION. Sportsmen who may visit Grand Haven are cordially invited to call on us.

Peter Wieringer, Grand Haven, Mich.

732,406. Firearm. Matt Goss, Duluth, Minn. Filed July 24, 1901. Serial No. 69,561. (No model.)



Claim.—A firearm, comprising a barrel and a stock, the stock having a recess and channel formed therein for receiving cartridges, a cartridge case adapted to be inserted in the recess, and means carried by the stock and projecting into the case, for forcing the cartridges into the channelway, together with means for presenting the cartridges to the barrel and firing mechanism of the piece.

Will some reader of RECREATION who has had experience give me some information, which may also be useful to many others. How can Mauser shells of German make be decapped?

What primers will suit 7.65 mm. Mauser shells?

How can a good surface be put on a gun stock without the glossy finish produced by varnish?

What will restore the blue finish on the barrel of a rifle, or be a fair substitute?

How is it done at the factory?

Will someone write an illustrated article for RECREATION describing the different kinds of twist in gun barrels, how they are made, and how they may be recognized?

Which is the more popular method of attaching a telescope to a rifle, by top or side mount?

F. A. G., Woodstock, N. B.

I am greatly pleased with Mr. Savage's letter in RECREATION. He certainly looks on the comments made in your magazine about his arms in the right light. He would no doubt take advantage of any good ideas advanced for the improvement of the Savage arms. Mr. Savage has certainly made many friends by his kindly reply. There is a great difference between his point of view and that of the Peters Cartridge Co. Jno. H. Dawson, Joplin, Mo.

My experience with the 30-30 has not been satisfactory; I have sold out and am going back to the old black powder rifle, which I believe is far ahead of the high power guns for accuracy.

There is not a page in RECREATION that is not interesting, and I do not see how any lover of the gun can get along without it.

M. W. Hodge, Dayton, Ore.

What is regarded as good penetration for a 12 gauge shot gun when loaded with one ounce No. 8 shot and the appropriate charge of smokeless powder? How, without complicated apparatus, can penetration be fairly determined?

Penetration, Pottsville, Pa.

Will some reader please answer.—EDITOR.

The shells put on the market by the Robin Hood Powder Co. are the best I ever used. The members of our camping club all use and praise them. Robin Hood is a particularly clean powder.

Dan Rifenburg, Bennington, Vt.

Doctor—Ah! out for a constitutional?

She—Yes; I walk 2 miles before breakfast every morning for my complexion.

"Is the drug store so far as that?"—London Tattler.

I am a printer and like to see good, neat work. Typographical appearance counts for a great deal in a magazine, and yours is A1. Edw. Bush, Buffalo, N. Y.

"Papa, what is a coquette?"

"Any girl, my son, that a man wants but can't get."—Exchange.

RECREATION is the best sportsmen's guide
W. N. Green, Kearny, N. J.

In family hotels they sing it. "Home, suite home."—Life.

NATURAL HISTORY.

When a bird or a wild animal is killed, that is the end of it. If photographed, it may still live and its educational and scientific value is multiplied indefinitely.

SHOULD THE ROBIN BE KILLED OFF?

I am in receipt of your letter of 24th, and am in full sympathy with your work for the protection of game and birds, excepting the English sparrow and the thieving and destructive robin. When the association will advocate and influence the sentimental women, and the men as well, to allow the penalty for killing a robin removed, I will contribute toward the funds of the association. The robin is a marauder and a thief, as well as the boy or man who would invade your orchard, garden or lawn and destroy or steal your berries, cherries, etc. The robin you protect, but the man you would arrest and punish. The man or boy might come once, but the robin is not satisfied until he has completed the destruction of the fruit.

I own a farm and am fond of raising every luxury in the way of fruit. I share it with my neighbors and friends. It costs money and labor. After all this, the pestiferous robin comes and destroys it, and the owner dare not protect his own property. This is not in keeping with good sense, much less sentiment.

The robin is not an insect-destroying bird. His food is the glow or ground worm, one of nature's provisions to perforate the soil, so the moisture can penetrate to the roots of the growing plant. This is an established fact and corroborated by all horticulturists.

I say raise a fund to exterminate the sparrow and kill the robin, so as to diminish the chances of losing an entire fruit crop by his marauding, thieving propensity. Every farmer in New Jersey will support and corroborate my statement. Kill the robin and the sparrow and I am with you.

J. A. Krunkel, Pennington, N. J.

Here is an extract from Farmers' Bulletin, No. 54, issued by the United States Department of Agriculture, which should convince Mr. Krunkel that he is wrong in advocating the wholesale destruction of the robin:

The food habits of the robin sometimes cause apprehension to fruit growers, for he is fond of cherries and other small fruits, especially the earlier varieties. For this reason many complaints have been lodged against him, and some persons have gone so far as to condemn the bird. The robin is, however, too valuable to be exterminated, and choice fruit can be readily protected from his depredations.

An examination of 330 stomachs shows that over 42 per cent of the robin's food is animal matter, principally insects, while the remainder is made up largely of small fruits and berries. Over 19 per cent consists of beetles, about 1-3 of which are ground beetles, taken mostly in spring and fall, when other insects are scarce. Grasshoppers make up about 1-10 of the whole food, but in August comprise over 30 per cent. Caterpillars form about 6 per cent, while the rest of the animal food, about 7 per cent, consists of various insects, with a few spiders, snails and angleworms. All the grasshoppers, caterpillars and bugs, with a large portion of the beetles, are injurious, and it is safe to say that noxious insects comprise more than 1-3 of the robin's food.

Vegetable food forms nearly 58 per cent of the stomach contents, over 47 being wild fruits, and only a little more than 4 per cent being possibly cultivated varieties. Cultivated fruit amounting to about 25 per cent was found in the stomachs in June and July, but only a trifle in August. Wild fruit, on the contrary, is eaten in every month, and constitutes a staple food during half the year. No less than 41 species were identified in the stomachs. Of these, the most important were 4 species of dogwood, 3 of wild cherries, 3 of wild grapes, 4 of greenbrier, 2 of holly, 2 of elder; and cranberries, huckleberries, blueberries, barberries, service berries, hackberries, and persimmons, with 4 species of sumac, and various other seeds not strictly fruit.

The depredations of the robin seem to be confined to the smaller and earlier fruits, and few, if any, complaints have been made against it on the score of eating apples, peaches, pears, grapes, or even late cherries. By the time these are ripe the forests and hedges are teeming with wild fruits, which the bird evidently finds more to its taste. The cherry, unfortunately, ripens so early that it is almost the only fruit accessible at a time when the bird's appetite has been sharpened by a long continued diet of insects, earthworms, and dried berries, and it is no wonder that at first the rich, juicy morsels are greedily eaten. In view of the fact that the robin takes 10 times as much wild as cultivated fruit, it seems unwise to

destroy the birds to save so little. Nor is this necessary, for by a little care both may be preserved. Where much fruit is grown, it is no great loss to give up one tree to the birds; and in some cases the crop can be protected by scarecrows. Where wild fruit is not abundant, a few fruit-bearing shrubs and vines judiciously planted will serve for ornament and provide food for the birds. The Russian mulberry is a vigorous grower and a profuse bearer, ripening at the same time as the cherry, and, so far as observation has gone, most birds seem to prefer its fruit to any other. It is believed that a number of these trees planted around the garden or orchard would fully protect the more valuable fruits.

Many persons have written about the delicate discrimination of birds for choice fruit, asserting that only the finest and costliest varieties are selected. This is contrary to all careful scientific observation. Birds, unlike human beings, seem to prefer fruit like the mulberry, that is sweetly insipid, or that has some astringent or bitter quality like the chokeberry or holly. The so-called black alder (*Ilex verticillata*), which is a species of holly, has bright scarlet berries, as bitter as quinine, that ripen late in October, and remain on the bushes through November; and though frost grapes, the fruit of the Virginia creeper, and several species of dogwood are abundant at the same time, the birds eat the berries of the holly to a considerable extent, as shown by the seeds found in the stomachs. It is, moreover, a remarkable fact that the wild fruits on which the birds feed largely are those which man neither gathers for his own use nor adopts for cultivation.

MIKE AND BEELZEBUB.

G. E. KASTENGREN.

Mike was only a monkey, it is true, but as full of concentrated deviltry, race prejudice, and loyalty to his many masters as are usually allotted to a dozen of his human relatives. He was a member of the 14th U. S. Infantry and particularly of Company F, in whose corner of the *cuartel* he was compelled to make his headquarters. A light, 8-foot chain made fast to the corner fence post allowed him to skip into an old sentry box, but while in there he had to hang on to sundry nails and pegs, for he could not reach the floor.

As to his race prejudice, he would no more dream of making friends with a Filipino than of taking a bath in boiling oil. As long as he was securely fastened, they would tease him until, in sheer disgust, he

would slip into his sentry box. A few yanks on the chain would bring him out on his fence post, where he would swear fearful oaths in simian volapuk. On one such occasion I happened along the fence, and when Mike spotted me he yelled in his own lingo that he was in sore trouble. No one could have failed to understand that appeal, for he was gesticulating like a wild Frenchman. I hurried up, and gave Mike a chance to take revenge into his own hands, by letting him loose. In about 5 seconds Mike had all the Filipinos in the vicinity shut up in their shacks; and then he tried the impossible task of doing sentry duty at every door at the same time. He almost succeeded, for I could only see a brown streak in the air. After a while he came back thoroughly exhausted, but he had gained the respect of the Filipinos.

Mike had many relatives in the *cuartel*, but they all belonged to a smaller species, while Mike was the size of a terrier. One of these little ones, Baby by name, had selected Mike as his protector, a task the latter accepted with much dignity. While he was engaged in picking over his ward he would allow no one to interfere, but if I let him understand that I had peanuts in my pocket he would drag Baby along and search me for edibles. He would never treat Baby until his own paunch and cheek pouches were filled to bursting.

Beelzebub belonged to the small species, but for deviltry he could hold his own against an African elephant. He escaped soon after his adoption by a misguided American soldier, who made a chain fast to the monkey but failed to make it fast to anything else. At the approach of anyone Beelzebub would skin up the water spout in no time and dance a can can on the hot corrugated iron; the rattling chain meanwhile preventing enjoyment of the siesta. Even at night he would suddenly remember that there was a better place to roost at the other end of the *cuartel*, and he would impartially distribute his rattling chain serenade to the whole regiment. Regulations and taps were nothing to him, and he seemed to enjoy being the cause of many a muttered midnight curse.

Beelzebub was the cause of the downfall of the whole *Cuartel de Malate* monkey colony. One day he invited the tribe to join him in a predatory expedition to the commanding officer's room. A pile of official papers on the desk was awaiting signature to become effective, including the papers of 2 court martials. Beelzebub led the raid through the open windows. On the desk were red and black ink in bright cut glass ink wells. With these 2 colors the monkeys painted a gorgeous tropical sunset on the court martial papers, and quietly departed. Their tracks were clearly out-

lined in black, carmine, and intermediate tints on floor and window sills. Their guilt was so evident that a blanket death sentence was pronounced.

Now comes the peculiar part of the yarn. No one had the heart to kill Mike, but somebody turned him loose and told him to find a safer place for permanent residence. He took the hint, and made his headquarters with the First Idahos, about 3 blocks away. Mike would always recognize his old friends, but a carload of peanuts would not induce him to return to *Cuartel de Malate*.

OUR TENANTS.

The first year they were a pair of song sparrows which built a nest in a tussock of grass by the brook. There was not a tree nor shrub on the place, and but little grass; but in the fall, after our land was graded, we put a hedge of good sized hemlocks in front of the house, and planted maples, elms and other rapid growing trees. Behind the house we made a small orchard, and set out berry bushes. We kept neither cat nor dog, and before the end of this first summer, robins and other birds were in the habit of flying across to our lot to pick up the crumbs and seeds we scattered about the door. After the young sparrows became large enough to fly they frequently joined their neighbors in these morning visits to the house.

The second year there were several sparrows' nests along the brook, presumably the pair of the previous year and their children, now gone to housekeeping for themselves. In the hemlocks were 2 robins' nests, a catbird's nest, and a cedar bird's. Besides these, a purple martin had shown her confidence in us by building a nest on one of the rafters of our porch.

At first the birds showed considerable shyness. When we were out of sight they would fly boldly about the door and on the porch, but as soon as we appeared would beat a precipitate retreat. Gradually this suspicion wore off, and by the time our strawberries were ripe the birds would eat from one end of the bed while we picked at the other.

This year more birds flew across to us from neighboring yards and from the woods, seeming to have communicated to each other the fact that seeds were to be found about our door, and that there were no dogs nor cats to molest them. Occasionally an oriole or a wood thrush would appear among them, and once a scarlet tanager flew from the woods, and, after a sharp scrutiny of the house, made a hasty meal from the seeds. When food became scarce, the birds grew bolder, and would even hop inquiringly into our kitchen. During the winter several sparrows and a pair of blue

jays took our hospitality for granted, and came regularly each morning for breakfast. Among our visitors was always a good sprinkling of snow buntings and stragglers that had failed to go South.

As our maples, and elms, and apple trees grew, other birds came and took possession of them, and before long we found ourselves in the midst of a select community of rare songsters. It is now our fourth year in the country, and we have only to open our windows in the morning to be treated to sweeter music than any trained orchestra could furnish.

F. H. Sweet, Palm Beach, Fla.

PROBABLY MR. PARK'S BEAVER.

I was interested to see in the December issue of RECREATION an account of a beaver which Mr. Park had seen traces of on a recent trip to Indian river. In September, in company with a friend, I explored much of the same territory, and during our stay at Kennell's old camp, on the Little Moose, our guide, Frank Baker, told me of a beaver dam which he had seen on a tributary not more than 2 miles from our camp. Baker is a careful observer of animal life, and he told us in such a way that I have every reason to believe it is the same beaver Mr. Park speaks of, and the one that gnawed through the wire grating and escaped from Governor Woodruff's place about 2 years ago. Baker had noted cuttings at several points along the Sumner stream, and on the still water above the old dam of Little Moose, near where the trail leads over to Beaver lake. He had also seen cuttings on Indian river and on Beaver lake itself. He found one tree 10 inches in thickness which was all but gnawed through. Whether it was the beaver's desire to find a remote region where he could live out his days unmolested by man, or whether he was seeking vainly a companion, I do not know; but at any rate I visited the dam the next morning and am convinced he had found the former. We spent most of the morning in carefully going over his work. He certainly was a busy little fellow, and it was evident from numerous trees and chips we examined that he had done all this work unaided. I feel sure there was but one beaver, because we observed no other tooth marks. The leaves of a large poplar tree, which he had felled near one of the skidding trails, were still fresh, and I judge the cutting had been done the night before. Not having a boat we were unable to discover his house. The dam raised the water 2 feet, and was strong enough to enable us to walk across.

This lone worker is what is commonly termed by trappers and woodsmen a bachelor beaver, although in this case he had not been ostracized by his kinsmen, as those

familiar with the habits of the animal assert is often the case. On my return from the woods I saw Mr. Middleton, the commissioner, and I trust that at the next meeting of the board they will decide to put in some more beavers.

Kensett Rossiter, Cambridge, Mass.

ANSWER BUCK SHOT.

Buck Shot, Milnor, N. Dak., asks how to poison coyotes. As a boy in the valley of the South Platte, in Colorado, I poisoned many in the following manner: I would take say a quarter of the carcass I wished to poison and drag it in a circle 2 or 3 miles across, and every few hundred yards would drop a small piece of meat with a killing dose of strychnine inserted in a gash, so the animal would not taste it. The drag always ended at the carcass. We would sometimes get 6 or 8 coyotes, some foxes, skunks, and occasionally a wolf.

D. M. P., El Paso, Tex.

Buck Shot, of Milnor, N. Dak., can poison coyotes in this way: Take fresh eggs, drill a small hole in the end of each and through the hole work strychnine into the contents of the shell. Then, after dipping the poisoned eggs in the white of another egg to seal the holes, leave them where a coyote will find them. You will surely get him.

W. A. Stoner, Priest River, Idaho.

NATURAL HISTORY NOTES.

Are there 2 kinds or species of mallard ducks? What work on natural history would you advise me to get, to set myself and others right on questions of this kind?

J. V. Myers, Larned, Kan.

ANSWER.

There is but one kind of mallard duck. The drake is marked by a conspicuous metallic-green head and neck and a gray body. The female is brown with black lines running lengthwise of the body. In appearance, the male and female differ widely; just as many other ducks do.

The best natural history will appear about February first, written by W. T. Hornaday, and published by Charles Scribner's Sons. Its title will be "The American Natural History," and it will be advertised in RECREATION.—EDITOR.

Please tell me if the whip-poor-will and the night hawk are the same bird.

E. E. Aplanalp, Hancock, N. Y.

ANSWER.

The whip-poor-will and the night hawk are birds of different species, but they belong to the same family and their habits are much alike. In flight, the night hawk may always be recognized, in the daytime, by the

large white spot underneath each wing. At night, the whip-poor-will is of course recognized by its cry. The night hawk is much more given to flying by day for the purpose of catching insects in the air than is the whip-poor-will. The scientific name of the whip-poor-will is *Antrostomus vociferous*; that of the night hawk is *Chordeiles virginianus*.—EDITOR.

I recently saw, in low bushes at the edge of a wood, a bird with grayish black back and tail, grayish white under parts, light brown throat, and a brown spot on top of head. Can you tell me its name? I took a shot at it with a camera, but have not developed the plate.

F. M. J., Gloucester, Mass.

It is impossible to identify the bird from the description you give. If you have succeeded in getting a good picture of it, please send me the print, and I shall then no doubt be able to tell you what the bird is.—EDITOR.

I notice in August RECREATION an inquiry from L. M. Badger about deer horns found in a crotch of an oak. Most likely the horns were placed there by some Indian hunter. It is common among some tribes to hang up horns of deer, elk and moose, and the paws of bear in this manner. I once found a set of moose horns embedded in a poplar tree. Red squirrels, chipmunks, wood rats, weasels, and, in fact, almost any of the smaller forest animals, will gnaw deer and moose horns.

F. L. Wilson, McEwen, Ore.

"Don't you suppose it is possible for a man to go through the world without telling a lie?"

"I doubt it. Almost every man has been in love at some time in his life."—Life.

I like RECREATION more than any magazine I have ever taken, and like it all the more because you place the rooters where they belong—in the pen.

A. E. Dabney, Staunton, Va.

The melancholy days have come,
The saddest of the year,
When man goes out and shoots a friend,
And thinks he is a deer.

—Yonkers Statesman.

I cannot do without RECREATION. My sisters take as much interest in it as I do, and that is saying considerable.

E. L. Cole, Pelican Rapids, Minn.

I never read a magazine that pleased me better than RECREATION.

Arthur E. Gage, Schenectady, N. Y.

THE LEAGUE OF AMERICAN SPORTSMEN.

GENERAL OFFICERS

President, G. O. Shields, 23 W. 24th St., New York.

1st Vice-President, E. T. Seton, 80 West 40th St., New York.

2d Vice-President, W. T. Hornaday, 2969 Decatur Ave., Bedford Park, N. Y.

3d Vice-President, Dr. T. S. Palmer, Dept. of Agriculture, Washington, D. C.

4th Vice-President, A. A. Anderson, 80 West 40th St., New York.

5th Vice-President, Hon. W. A. Richards, General Land Office, Washington, D. C.

Secretary, A. F. Rice, 155 Pennington Ave., Passaic, N. J.

Treasurer, Austin Corbin, of the Corbin Banking Co., 192 Broadway, New York.

STATE DIVISIONS

ALASKA

Dr. E. M. Rininger, Chief Warden, Nome.

ARIZONA.

M. J. Foley, Chief Warden, Jerome.

ARKANSAS

W. R. Blocksom, Chief Warden, Eureka Springs.

CALIFORNIA.

Dr. David Starr Jordan, Chief Warden, Leland Stanford University.

COLORADO.

A. Whitehead, Chief Warden, 303 Tabor Building, Denver.

CONNECTICUT.

Hon. F. P. Sherwood, Chief Warden, Southport; Dr. H. L. Ross, Vice-Warden, Canaan; H. C. Went, Sec.-Treas., Bridgeport.

DISTRICT OF COLUMBIA.

C. H. Townsend, Chief Warden, U. S. Fish Commission.

FLORIDA.

W. W. K. Decker, Chief Warden, Tarpon Springs.

GEORGIA.

J. J. Doughty, Chief Warden, Augusta.

IDAHO.

L. A. Kerr, Chief Warden, Kendrick.

ILLINOIS.

M. D. Ewell, M.D., Chief Warden, 59 Clark St., Chicago; F. M. Taber, Vice Warden, 144 Kinzie St., Chicago; G. C. Davis, Sec.-Treas., 123 S. Central Ave., Austin.

INDIANA.

John J. Hildebrandt, Chief Warden, Logansport; O. R. Moore, Vice-Warden, Anderson; Dr. M. L. Humston, Sec.-Treas., Goodland.

IOWA.

Carl Quimby, Chief Warden, Des Moines; C. C. Proper, Sec.-Treas., Des Moines.

KANSAS.

O. B. Stocker, Chief Warden, Wichita.

KENTUCKY.

Geo. C. Long, Chief Warden, Hopkinsville.

MAINE.

Col. E. C. Farrington, Chief Warden, Augusta.

MARYLAND.

J. E. Tylor, Chief Warden, Cxford.

MASSACHUSETTS.

Heman S. Fay, Chief Warden, Hazleton Block, Marlboro; J. E. Tweedy, Vice-Warden, North Attleboro; A. C. Lamson, Sec.-Treas., 194 Main St., Marlboro.

MICHIGAN.

J. Elmer Pratt, Chief Warden, Grand Rapids; R. S.

Woodliffe, Vice-Warden, Jackson; A. B. Richmond, Sec.-Treas., Grand Rapids.

MINNESOTA.

Dietrich Lange, Chief Warden, 2294 Commonwealth Ave., St Paul; H. A. Morgan, Vice-Warden, Albert Lea; Prof. O. T. Denny, Sec.-Treas., St. Paul.

MISSOURI.

Bryan Snyder, Chief Warden, 726 Central Bldg., St. Louis.

MONTANA.

Professor M. J. Elrod, Chief Warden, Missoula; Sidney M. Logan, Vice-Warden, Kalispell; R. A. Waagner, Sec.-Treas., Bozeman.

NEBRASKA.

Fred. E. Mockett, Chief Warden, Lincoln; P. O'Mahony, Sec.-Treas., Lincoln.

NEVADA.

Dr. W. H. Cavell, Chief Warden, Carson; Geo. W. Cowing, Sec.-Treas., Carson.

NEW HAMPSHIRE.

Dr. A. F. Barrett, Sentinel Bldg., Keene; Sidney Conant, Sec.-Treas., Keene.

NEW JERSEY.

Percy Johnson, Chief Warden, Bloomfield; Dr. W. S. Colfax, Vice-Warden, Pompton Lakes; I. V. Dorland, Sec.-Treas., Arlington.

NEW MEXICO.

P. B. Otero, Chief Warden, Santa Fe.

NEW YORK.

John R. Fanning, Chief Warden, Powers' Bldg., Rochester; Col. R. E. Moss, Vice-Warden, Wallack's Theatre, New York City; Dr. C. C. Curtis, Sec.-Treas., Columbia College, New York City.

NORTH DAKOTA.

Dr. W. D. Jones, Chief Warden, Devil's Lake.

OHIO.

W. E. Gleason, Chief Warden, Mitchell Bldg., Cincinnati; A. C. Thatcher, Vice-Warden, Urbana.

OKLAHOMA.

W. M. Grant, Chief Warden, Oklahoma City.

ONTARIO.

C. A. Hammond, Chief Warden, Box 701, St. Thomas; D. L. Mells, Sec.-Treas., St. Thomas.

OREGON.

Robert F. Kelly, Chief Warden, Box 188, The Dalles; C. B. Cushing, Sec.-Treas., The Dalles.

PENNSYLVANIA.

C. F. Emerson, Chief Warden, 189 N. Perry St., Titusville; Hon. C. B. Penrose, Vice-Warden, 1720 Spruce St., Philadelphia.

RHODE ISLAND.

Zenas W. Bliss, Chief Warden, 49 Westminster St., Providence.

SOUTH CAROLINA.

C. F. Dill, Chief Warden, Greenville.

SOUTH DAKOTA.

D. C. Booth, Chief Warden, Spearfish; John C. Barber, Sec.-Treas., Lead.

TENNESSEE.

Hon. G. C. Martin, Chief Warden, Clarksville; Hon. Austin Peay, Jr., Sec.-Treas., Clarksville.

TEXAS.

Prof. S. W. Stanfield, Chief Warden, San Marcos; W. E. Heald, Sec.-Treas., San Angelo.

UTAH.

Hon. John Sharp, Chief Warden, Salt Lake City.

VERMONT.

S. C. White, Sec.-Treas., Woodstock.

VIRGINIA.

R. G. Bickford, Chief Warden, Newport News; C. O. Saville, Vice-Warden, Richmond; M. D. Hart, Sec.-Treas., 1217 East Main St., Richmond.

WASHINGTON.

F. S. Merrill, Chief Warden, Spokane; F. A. Pontius, Sec.-Treas., Seattle; Munro Wyckoff, Vice-Warden, Pt. Townsend.

WEST VIRGINIA.			County.	Name of Warden.	Address.
E. F. Smith, Chief Warden, Hinton,			Alleghany,	G. A. Thomas,	Belvidere.
WISCONSIN.			Broome,	John Sullivan,	Sanitaria Springs
Frank Kaufman, Chief Warden, Two Rivers; Dr.			Cayuga,	R. R. Mathewson,	Binghamton.
A. Gropper, Sec.-Treas., Milwaukee.			Chemung,	H. M. Haskell,	Weedsport.
WYOMING.			"	Fred. Uhle,	Hendy Creek,
H. E. Wadsworth, Chief Warden, Shoshone			Columbia,	M. A. Baker,	Elmira.
Agency; Frank Bond, Sec.-Treas., Cheyenne.			Cortland,	A. B. Miller,	Jackson's Corners
<i>Applications for membership and orders for badges</i>			Dutchess,	James Edwards,	Cortland,
<i>should be addressed to Arthur F. Rice, Secretary, 23 W.</i>			"	A. B. Miller,	Jackson's Corners.
<i>24th St., New York.</i>			"	Chas. H. DeLong,	Pawling.
LOCAL WARDENS			Erie,	Jacob Tompkins,	Billings.
CONNECTICUT.			Essex,	Marvin H. Butler,	Morilla.
County.	Name of Warden.	Address.	Franklin,	W. H. Broughton,	Moriah.
Fairfield,	George B. Bliss.	2 Park Row, Stamford.	Greene,	Jan. Eccles,	St. Regis Falls.
"	Harvey C. Went,	11 Park St., Bridgeport.	Hamilton,	W. J. Soper,	Windham.
"	Samuel Waklee,	Box 373, Stratford.	Herkimer,	David Aird, Jr.	Lake Pleasant.
Litchfield,	Dr. H. L. Ross,	P. O. Box 100, Canaan.	Jefferson,	D. F. Sperry,	Old Forge.
Middlesex,	Sandford Brainerd,	Ivoryton.	"	C. J. Smith,	Watertown.
New Haven,	Wilbur E. Beach,	318 Chapel Street, New Haven.	Livingston	A. C. Cornwall,	Alexandria Bay,
"	D. J. Ryan,	188 Elizabeth St., Derby.	"	Jos. Northrup,	"
FLORIDA.			Montgomery,	M. De La Vergne,	Lakeville.
Brevard,	C. H. Racey,	Waveland.	New York,	K. S. Chamberlain,	Mt. Morris.
ILLINOIS.			Oneida,	Henry Skinner,	Springwater.
Iroquois,	J. L. Peacock,	Sheldon.	Orange,	Dr J. W. Cowan,	Geneseo.
Rock Island,	D. M. Slottard,	12th Ave. and 17th St., Moline.	Orleans,	Charles W. Scharf.	Canajoharie.
IOWA.			Oswego,	C. L. Meyer,	46 W. B'way, N.Y. City.
Clinton,	D. L. Pascol,	Grand Mound.	Putnam,	J. M. Scoville,	Clinton.
Pottawattamie,	Dr. C. Engel,	Crescent.	Queens,	James Lush,	Memphis.
KANSAS.			"	J. Hampton Kidd,	Newburgh.
Ness,	Frank Lake,	Ransom.	"	Thomas Harris,	Port Jervis.
MASSACHUSETTS.			Oswego,	J. H. Fearby,	E. Shelby.
Norfolk,	Orlando McKenzie,	Norfolk.	Putnam,	J. E. Manning,	154 West Utica St.
"	J. J. Blick,	Wrentham.	Queens,	H. L. Brady,	Oswego.
"	S. W. Fuller,	East Milton.	"	Gerard Van Nostrand,	Mahopac Falls.
Suffolk,	Capt. W. J. Stone,	4 Tremont Row, Boston.	"	W. S. Mygrant,	Flushing, L. I.
Worcester,	B. H. Mosher,	Athol.	"	P. A. Geepel,	46 Elton Street, Brooklyn.
MICHIGAN.			"	L. B. Drowne,	473 Grand Ave., Astoria, L. I.
Berrien,	W. A. Palmer,	Buchanan.	"	Lewis C. Att,	119 Somers Street, Brooklyn.
Cass,	Thomas Dewey,	Dowagiac.	Richmond.	Lewis Morris.	Broad Channel Hotel, Rockaway, L. I.
Hillsdale,	C. A. Stone,	Hillsdale.	St. Lawrence,	Dr. B. W. Severance,	Port Richmond.
Kalamazoo,	C. E. Miller,	Augusta.	"	A. N. Clark,	Gouverneur.
Lake,	John Trieber,	Peacock.	Schenectady,	J. W. Furnside,	Sevey.
Ottawa,	W. H. Dunham,	Spencer.	Schoharie,	O. E. Eigen,	Schenectady.
NEBRASKA.			Schuyler,	G. C. Fordham,	Sharon Springs.
Hall,	E. C. Statler,	Grand Island	Suffolk,	F. J. Fellows,	Watkins.
NEW HAMPSHIRE.			"	P. F. Tabor,	Central Islip, L. I.
Cheshire,	S. C. Ellis,	Keene.	Tioga,	Geo. Wood,	Orient, L. I.
Sullivan,	G. A. Blake,	Lempster.	Ulster,	M. A. DeVal,	Owego.
"	J. W. Davidson,	Charlestown.	"	Wm. S. Mead,	The Corners.
NEW JERSEY.			Warren,	Geo. McEchron,	Woodstock.
Hudson,	A. W. Letts,	51 Newark St., Hoboken	Washington,	C. L. Allen,	Glens Falls.
Mercer.	Edw. Vanderbilt,	Dentzville, Trenton.	"	J. E. Barber,	Sandy Hill.
"	Roland Mitchell,	739 Centre St., Trenton	"	A. S. Temple,	Dresden.
"	F. C. Wright,	Trenton.	Westchester,	George Poth,	Whitehall.
Monmouth.	Dory-Hunt,	Wanaque.	"	Chas. Seacor,	Pleasantville.
Morris,	Joseph Pellet,	Pompton Plains.	"	M. W. Smith,	57 Pelham Road, New Rochelle.
"	Chas. W. Blake,	Dover.	"	Ralph Gorham,	Croton Falls.
"	Francis E. Cook,	Butler.	Yates,	B. L. Wren,	Mt. Kisco.
"	Calone Orr,	Hibernia.	"	Seymour Poineer,	Penn Yan.
Somerset,	G. E. Morris,	Somerville.	"	"	Branch Port.
Sussex,	Isaac D. Williams,	Branchville.	OHIO.		
Union,	A. H. Miller,	Cranford.	Allen,	S. W. Knisely,	Lima.
"	C. M. Hawkins,	Roselle.	Clark,	Fred C. Ross,	169 W. Main St., Springfield.
Warren,	Jacob Young,	Phillipsburg.	Cuyahoga,	A. W. Hitch,	161 Osborn St., Cleveland.
"	Reuben Warner,	"	Erie,	David Sutton,	418 Jackson St., Sandusky.
NEW YORK.			Franklin,	Brook L. Terry,	208 Woodward Av., Columbus.
Albany,	C. D. Johnson,	Newtonville.	Fulton,	L. C. Berry,	Swanton.
"	Kenneth E. Bender,	Albany.	Hamilton,	W. C. Rippey,	4465 Eastern Ave., Cincinnati.
"	W. S. Swift,	Voorheesville.	Knox,	Grant Phillips,	Mt. Vernon.
			Lorain,	T. J. Bates,	Elyria.
			Muskingum,	Frank D. Abell,	Zanesville.
			Ottawa,	Frank B. Shirley,	Lakeside.
			Scioto,	J. F. Kelley,	Portsmouth.
			Stark,	A. Dangeleisen,	Massillon.
			OKLAHOMA.		
			Kiowa and Comanche Nation,	A. C. Cooper,	Ft. Sill.

PENNSYLVANIA.

County.	Name of Warden.	Address.
Allegheny,	S. H. Allen,	Natrona.
Beaver,	N. H. Covert,	Beaver Falls.
	W. R. Keefer,	"
Bradford,	Geo. B. Loop,	Sayre.
Butler,	F. J. Forquer,	Murrinsville.
	J. W. McGill,	Harrisville.
Cambria,	W. H. Lambert,	720 Coleman Ave., Johnstown.
Cameron,	Harry Hemphill,	Emporium.
Carbon,	Asa D. Hontz,	East Mauch Chunk.
Clarion,	Isaac Keener,	New Bethlehem.
Clinton,	M. C. Kepler,	Renovo.
"	Geo. L. Kepler,	"
"	R. T. Antes,	Pine Station
Crawford,	Jasper Tillotson,	Tillotson.
"	Geo. T. Meyers,	Titusville.
"	J. B. Lamb,	Buel.
Cumberland,	J. C. Gill,	Mechanicsburg.
Delaware,	Walter Luson,	Ardmore.
Elk,	D. R. Lobaugh,	Ridgway.
Fayette,	Ely Cope,	Cadwallader.
Jefferson,	John Noll,	Sykesville.
Juniata,	Clifford Singer,	Oakland Mills.
	Ezra Phillips,	McAlesterville.
Lackawanna,	Wm. Weir,	Moosic.
"	Wm. Major,	"
"	Frank A. Tarlox,	Wimmers.
Lycoming,	Jas. J. Brennan,	Oval.
"	B. D. Kurtz,	Cammal.
McKean,	C. A. Duke,	Duke Center.
"	L. P. Fessenden,	Granere.
"	Wm. Holsinger,	Stickney.
Montgomery,	L. C. Parsons,	Academy.
Northumberland,	G. W. Roher,	505 Anthracite St., Shamokin.
Perry,	Samuel Sundry,	Lebo.
Potter,	Ira Murphy,	Coudersport.
"	Wiley Barrows,	Austin.
"	Chas. Barrows,	Austin.
Tioga,	E. B. Beaumont, Jr.,	Lawrenceville
	G. H. Simmons,	Westfield.
Venango,	G. D. Benedict,	Pleasantville.
Warren,	F. P. Sweet,	Goodwill Hill.
	Nelson Holmes,	Cornplanter.
Wyoming,	Cyrus Walter,	Tunkhannoc.

TENNESSEE.

Madison,	H. T. Rushing,	Jackson.
Montgomery,	P. W. Humphrey,	Clarksville.
Robertson,	C. C. Bell,	Springfield.
Stewart,	John H. Lory,	Bear Spring.
Sumner,	W. G. Harris,	Gallatin.

UTAH.

Washington,	S. C. Goddard,	New Harmony.
"	J. A. Thornton,	Pinto.

VERMONT.

Essex,	H. S. Lund,	Granby.
Orleans,	E. G. Moulton,	Derby Line.
Rutland,	Wm. J. Liddle,	Box 281, Fair Haven
Windsor,	F. A. Tarbell,	West Bridgewater.

VIRGINIA.

Henrico,	W. J. Lynham,	412 W. Marshall, Richmond.
King & Queen,	R. D. Bates,	Newtown.
King William,	N. H. Montague,	Palls.
Louisa,	J. P. Harris,	Applegrove.
Mecklenburg,	J. H. Ogburn,	South Hill.
Smythe,	J. M. Hughes,	Chatham Hill.

WASHINGTON.

Okanogan,	James West,	Methow.
Stevens,	Jacob Martin,	Newport.
"	L. H. Lee,	Northport.
Yakima,	J. Brachmann,	N. Yakima.

WYOMING.

Carbon,	Kirk Dyer,	Medicine Bow.
Fremont,	Nelson Yarnall,	Dubois.
Laramie,	Martin Breither,	Cheyenne.
Uinta,	{ S. N. Leek, F. L. Peterson, }	Jackson.

LOCAL CHAPTERS.

Albert Lea, Minn.,	H. A. Morgan,	Rear Warden.
Anadarka, O. T.,	Bert Smith,	"
Angelica, N. Y.,	C. A. Lathrop,	"

Augusta, Mont.,	H. Sherman,	Rear Warden.
Austin, Minn.,	G. F. Baird,	"
Austin, Pa.,	W. S. Warner,	"
Boston, Mass.,	Capt. W. I. Stone,	"
Buffalo, N. Y.,	H. C. Gardiner,	"
Cammal, Pa.,	B. A. Ovenshire,	"
Champaign Co., O.	Hy. F. MacCracken	"
	Urbana,	"
Charlestown, N. H.,	W. M. Buswell,	"
Cheyenne, Wyo.,	J. Hennessy,	"
Choteau, Mont.,	G. A. Gorham,	"
Cincinnati, Ohio,	B. W. Morris,	"
Coudersport, Pa.,	I. L. Murphy,	"
Cresco, Iowa,	J. L. Platt,	"
Cross Village, Mich.,	Job Rohr,	"
Davis, W. Va.,	J. Heltzen,	"
Dowagiac, Mich.,	W. F. Hoyt,	"
East Mauch Chunk, Pa.,	E. F. Fry,	"
Evansville, Ind.,	F. M. Gilbert,	"
Fontanet, Ind.,	W. H. Perry,	"
Ft. Wayne, Ind.,	W. L. Waltemarth	"
Great Falls, Mont.,	J. M. Gaunt,	"
Heron Lake, Minn.,	K. C. Buckeye,	"
Hollidays'bg, Pa.,	T. J. Hemphill	"
Hopkinsville, Ky.,	Hunter Wood,	"
Indianapolis, Ind.,	Joseph E. Bell,	"
Jerome, Ariz.,	Dr. L. A. Hawkins,	"
Johnsonburg, Pa.,	W. J. Stebbins,	"
Kalispell, Mont.,	John Eakright,	"
Keene, N. H.,	F. P. Beedle,	"
Kingfisher, Okla.,	A. C. Ambrose,	"
Lake Co., Ind.,	Dr. R. C. Mackey,	"
Lawton, O. T.,	Marion Miller,	"
Lincoln, Neb.,	A. J. Sawyer	"
Logansport, Ind.,	E. B. McConnell,	"
Ludington, Mich.,	G. R. Cartier,	"
McElhattan, Pa.,	A. B. Winchester,	"
Mechanicsburg, Pa.,	Dr. J. H. Swartz,	"
Minturn, Colo.,	A. B. Walter,	"
Morgantown, W. Va.,	B. S. White,	"
New Albany, Ind.,	Dr. J. F. Weathers,	"
New Bethlehem, Pa.,	Isaac Keener,	"
Oklahoma City O. T.,	N. F. Gates,	"
Penn Yan, N. Y.,	Dr. H. R. Phillips,	"
Phillips, Wis.,	F. K. Randall,	"
Princeton, Ind.,	H. A. Yeager,	"
Reynoldsville, Pa.,	C. F. Hoffman,	"
Ridgway, Pa.,	T. J. Maxwell,	"
Rochester, N. H.,	Gustave Andreas,	"
"	N. Y.,	"
"	C. H. McChesney	"
St. Paul, Minn.,	O. T. Denny,	"
St. Thomas, Ont.,	L. J. Hall,	"
Schenectady, N. Y.,	J. W. Furnside,	"
Seattle, Wash.,	M. Kelly,	"
Syracuse, N. Y.,	C. C. Truesdell,	"
Terre Haute, Ind.,	C. F. Thiede,	"
The Dalles, Ore.,	C. B. Cushing,	"
Two Harbors, Minn.,	T. D. Budd,	"
Walden, N. Y.,	J. W. Reid,	"
Wichita, Kas.,	Gerald Volk,	"
Winona, Minn.,	C. M. Morse,	"

LIFE MEMBERS OF THE LEAGUE.

Anderson, A. A.,	80 W. 40th St., New York City.
Beard, D. C.,	204 Amity St., Flushing, L. I.
Blackstone, Lorenzo,	Norwich, Conn.
Buzzacott, Francis F.,	Chicago, Ill.
Brown, J. Stanford,	489 Fifth Ave., New York City.
Butler, C. E.,	Jerome, Ariz.
Carey, Hon. H. W.,	Eastlake, Mich.
Carnegie, Andrew,	2d, Fernandina, Fla.
Carnegie, George,	Fernandina, Fla.
Carnegie, Morris,	Fernandina, Fla.
Corbin, Austin,	192 Broadway, New York City.
Dickinson, E. H.,	Moosehead Lake, Me.
Edgell, G. S.,	192 Broadway, New York City.
Ellis, W. D.,	136 W. 72d St., New York City.
Fearing, D. B.,	Newport, R. I.
Ferry, C. H.,	1720 Old Colony Bldg., Chicago, Ill.
Ferry, Mansfield,	183 Lincoln Park Boulevard, Chicago, Ill.
Fraser, A. V.,	478 Greenwich St., New York City.
Gilbert, Clinton,	2 Wall St., New York City.
Hudson, E. J.,	33 E. 35th St., Bayonne, N. J.
McClure, A. J.,	158 State St., Albany, N. Y.
Mershon, W. B.,	Saginaw, Mich.
Miller, F. G.,	108 Clinton St., Defiance, O.

Morton, Hon. Levi P., 681 Fifth Ave., New York City.
 Nesbitt, A. G., Maple St., Kingston, Pa.
 O'Connor, Col. J. C., 24 E. 33d St., New York City.
 Pierson, Gen. J. F., 20 W. 52d St., New York City.
 Prescott, A. L., 90 W. Broadway, New York City
 Rice, A. F., 155 Pennington Ave., Passaic, N. J.
 Seton, E. T., 80 W. 40th St., New York City.
 Seymour, J. H., 35 Wall St., New York City.
 Smith, E. B., Bourse Bldg., Philadelphia, Pa.
 Smith, W. H., Bryn Mawr, Pa.
 Thompson, J. Walter, Times Bldg., New York City.
 Towne, E. S., Care of National Blank Book Co., Holyoke, Mass.
 Underwood, W. L., 52 Fulton St., Boston, Mass.
 Valentine, Dr. W. A., 5 W. 35th St., New York City.
 H. Williams, Box 156, Butte, Mont.

DISCOUNTS TO LEAGUE MEMBERS.

The following firms have agreed to give members of the L. A. S. a discount of 2 per cent. to 10 per cent. on all goods bought of them. In ordering please give L. A. S. number:

Syracuse Arms Co., Syracuse, N. Y. Guns.
 Davenport Fire Arms Co., Norwich, Conn. Shot guns, rifles.
 Gundlach Optical Co., Rochester, N. Y. Photographic goods.
 Blair Camera Co., Rochester, N. Y. Photographic goods
 James Acheson, Talbot St., St. Thomas, Ontario, Sporting goods.

THE ANNUAL MEETING.

At this writing there is an excellent prospect that the annual meeting in Columbus, O., February 10th, will be a great event. We already have assurance from the following League officers and delegates that they will be present:

Dr. T. S. Palmer, Vice-President, Washington, D.C.
 W. W. K. Decker, Chief Warden, Tarpon Springs, Fla.
 Col. Geo. C. Long, Chief Warden, Hopkinsonville, Ky.
 G. C. Martin, Delegate, Brooksville, Fla.
 W. Van Irons, Delegate, Bliss, Idaho.
 Dr. F. Schavoir, Delegate, Stamford, Ct.
 W. H. Duncan, Delegate, Barnwell, S. C.
 C. H. Chapman, State Fish and Game Warden, Sault Ste. Marie, Mich.
 C. E. Brewster, Deputy Fish Warden, Grand Rapids, Mich.
 Homer Sheridan, Delegate, Mount Clemens, Mich.
 C. A. Cooper, Rear Warden, Fort Sill, O. T.
 T. E. Dawson, Delegate, Midvale, Mont.
 W. F. Scott, State Fish and Game Warden, Helena, Mont.
 M. J. Elrod, Chief Warden, Missoula, Mont.
 Hon T. R. Kershaw, State Game Commissioner, Whatcom, Wash.
 E. P. Dorr, Delegate, Chicago, Ill.
 S. L. N. Ellis, Chief Warden, Visalia, Cal.
 Sam Fullerton, Executive Agent, State Fish and Game Commission, St. Paul, Minn.
 Hon. L. T. Christian, Delegate, Richmond, Va.
 C. W. Robinson, Delegate, Newport News, Va.
 H. G. Smith, Treasurer State Board of Fish and Game Commissioners, Winona, Minn.
 W. E. Gleason, Chief Warden, Cincinnati, O.
 A. C. Thatcher, Secretary-Treasurer, Urbana, O.
 George Lilienthal, Delegate, Zanesville, O.
 Hon. J. C. Porterfield, State Game Warden, Columbus, Ohio.
 C. F. Emerson, Chief Warden, Titusville, Pa.
 W. H. Gardner, Delegate, Hollidaysburg, Pa.

C. H. Pond, Delegate, Scranton, Pa.
 Dr. Jos. Kalbfus, Secretary State Game Commission, Harrisburg, Pa.
 A. F. Rice, Secretary, Passaic, N. J.
 P. H. Johnson, Chief Warden, Bloomfield, N. J.
 W. T. Hornaday, Vice-President, New York.
 Wm. Benton, Delegate, Holmes, Wyoming.
 F. C. Wright, Delegate, Trenton, N. J.
 G. A. Lincoln, State Fish and Game Warden, Cedar Rapids, Iowa.
 Hon. P. B. Otero, Chief Warden, Santa Fe, N. M.
 Dr. E. M. Rininger, Chief Warden, Nome, Alaska.
 D. C. Nowlin, State Game Warden, Lander, Wyo.
 J. W. Baker, State Game Warden, Portland, Ore.
 John J. Hildebrandt, Chief Warden, Logansport, Ind.
 Hon. Frank Littleton, Ex-Chief Warden, Indianapolis, Ind.
 J. E. Tylor, Chief Warden, Baltimore, Md.
 Ernest Russell, Delegate, Worcester, Mass.
 Dr. A. Gropper, Secretary-Treasurer, Milwaukee, Wis.
 Valentine Raeth, Delegate, Milwaukee, Wis.

Officers in several other States are planning to attend, but have not yet completed arrangements. The Ohio officers and members are making elaborate preparations to entertain visitors, and there is every indication that this meeting will surpass all its predecessors in numbers and in interest.

BALLADS OF BAD BABIES.

HARRY P. TABER, in the Saturday Evening Post.

Rodolph Mortimer McPhee
 Chopped his papa's apple tree;
 Took it to the shed and hid it.
 When his papa asked who did it,
 "I don't know," said Rodolph, "I
 Ain't afraid to tell a lie.
 I won't tell you what I've done.
 I ain't no George Washin'ton."

Little Heinie Hassenpfeffer
 Saw a gentle Jersey heifer
 Eating up her noonday fodder.
 "Ha!" he said, "I'll go an' prod 'er
 With a pitchfork, so's to show 'er
 She can't do so any more."
 But the gentle Jersey heifer
 Prodded Heinie Hassenpfeffer.

Once when little Jimmy Binner
 Had some custard pie for dinner,
 He saw Uncle Joseph Tate
 Coming through the garden gate.
 Jimmy threw his custard pie
 And hit his uncle in the eye.
 "Gee!" said little Jimmy Binner,
 "Pretty good for a beginner!"

Wilhelmina Mergenthaler
 Had a lovely ermine collar
 Made of just the nicest fur,
 That her mamma bought for her.
 Once, when mamma was away,
 Out a-shopping for the day,
 Wilhelmina Mergenthaler
 Ate her lovely ermine collar.

FORESTRY.

EDITED BY DR. B. E. FERNOW.

It takes 30 years to grow a tree and 30 minutes to cut it down and destroy it.

WHAT IS FORESTRY?

In a former issue of RECREATION I defined a forest as a piece of woodland placed under man's care for the purpose of producing wood crops and incidentally serving the further purposes of soil protection, regulating of waterflow, and pleasure. The care of such woodlands is forestry.

Forestry has to deal with aggregates of trees, stands, acres, all devoted to one end, namely, the production of a wood crop. It does not, therefore, deal with the individual trees, except as they are components of a crop, any more than the farmer deals with the single potato plant. It is a misnomer to speak of "city foresters," unless a city really own a forest and have a manager employed; a commendable thing to have. To apply to the guardians of the park and street trees, the tree wardens, the appellation of "forester" is, to say the least, unfortunate. Indeed, it has been mischievous; it has misled the public, befogged its intellect as to the real meaning of forestry and foresters. It has, like the misused arbor days, introduced the æsthetic and the sentimental side into the discussions of forestry, and has clouded the economic, much more important, questions of forestry in the minds of newspaper writers and the public.

The beauty and shade of trees are good things to take care of, and the tree warden is a laudable institution, but his work has nothing to do with forestry, which is after the substance of the tree, and, like the lumberman, after logs.

Even those who realize that forestry has to do with the forest as a crop, have still in mind that their duty as citizens is to insist on forest preservation, and they believe this is obtained by preventing the bad lumberman from cutting altogether, or, at least, cutting below certain sizes.

Some years ago a group of gentlemen in New York proposed to secure the passage of legislation restricting the lumbermen in the State of New York from cutting below a certain diameter, and they called on me, as an expert, to tell them what, under proper forestry principles, would be the right diameter to lay down as a law. Great was their astonishment when I declared that any diameter which paid best, even down to the size of the little finger, would satisfy the demands of forestry. There is only one obligation which distinguishes the forester from the lumberman, and that one makes all the difference in method between the 2, namely, the obligation or reproduc-

tion; replacing the harvested crop. Both forester and lumberman are in the business of supplying the industries with wood material, only the lumberman does it by harvesting the accumulations of the past without reference to the future. The logger is merely a converter into useful shape of what nature unattended has grown. He works for the present only.

The forester prepares himself to do the same thing, namely, to convert nature's accumulations for man's use; but he conceives that the need for this material will continue, and he provides for that continuance by securing a new crop of serviceable timber to replace the harvested one. Financially the 2 forest managers—lumberman and forester—are also to a certain extent in the same boat. Both carry on their business for profit, and not for æsthetic purposes; but the lumberman is handling only "call money." He seeks only present profit. The forester treats his forest as an investment; he calculates his profits from and for the long run. Continuity is the keynote of forest management by the forester.

There is absolutely no difference between forester and farmer except as to the kind of crop each raises on his soil, and the manner in which he treats his crop. The forester, like the farmer, raises a crop, the wood crop; but, of course, he also harvests the crop. Hence, when a legislative committee found fault with the Cornell Forest demonstration, because the old, over-mature crop of nature was harvested to be replaced by a better crop, the committee simply exhibited its ignorance as to what forestry implies. The forester preserves the forest not by abstaining from cutting it, but, as all life is preserved, by reproducing it.

There are various methods of doing this, and only an expert can decide which, under given conditions, is the best. These methods of producing a wood crop and of tending it after it is produced until harvest time, are called silviculture. from the Latin words *silva*, forest, and *cultura*, cultivation.

Why should we apply cultivation to a crop which evidently can be grown by nature alone in satisfactory quality? For the same reason that the farmer applies cultivation to his crop, namely, to secure a better result than nature alone can produce; bigger potatoes, more of them to the acre; larger apples of better taste, and just so, more and better wood per acre in a shorter time!

If Nature were left alone she would reproduce all the forests we have cut, provid-

ed she had time allowed her, and she would produce as much wood per acre as she can; but she would not make a selection of the useful kinds alone. She would give the tree weeds just as much chance as the valuable trees, and she would not care whether it took 100 years or 1,000 years to produce a desirable log. It is this time element which is of moment to man. Economy of time and economy of space are his requirements in all production. To grow the most useful, the most valuable wood in largest quantity in the shortest time is what the forester sets out to do, and thus he improves on Nature's wasteful way. As long as there are virgin stores to draw from his art may be despised, for it is not needed; only when these stores are exhausted or nearly so, and when the realization comes that a serviceable log can not be grown by Nature in less than 150 or by man in less than 60 to 120 years, does the care of the forester appear desirable. Forestry is a child of necessity.

FORESTRY TESTS AT ST. LOUIS.

The following, which has been making the rounds of the newspapers, this particular clipping to be credited to the New York Times, is worth reprinting to show what utter nonsense regarding forestry matters is being served to the gullible public.

If this statement had been printed in the comic columns, and, especially, if it had had the benefit of Mr. Dooley's inimitable method of presentation, it would probably have done immense service in showing the absurdities of certain alleged friends of forestry. But no, this is given as a piece of news in sober seriousness!

The United States Government will participate in a competitive exhibit at the St. Louis Fair, and will have for a rival the German Empire. Which nation's method of forest management is best and most practical is the problem to be solved.

This competitive exhibit will have especial interest for the State of New York on account of the experiments in forestry which New York has been making with a view to the preservation of the forests of the Adirondacks. The New York experiments have been made under the auspices of the Cornell University, to which State lands were ceded for the purpose.

The experiments have been so unsatisfactory that they are now the subject of investigation by the Legislature of New York. It is expected by those who will be in charge of the United States' forestry exhibit at St. Louis that the Legislature of New York at the coming session may see fit to appoint an expert on forestry to go to St. Louis to study the experiments in forestry methods to be made there, with a view to affording the Legislature light on a problem which has been vexing the officials of New York for several years past.

Two tracts of land, each about 5 acres in extent, have been assigned to each Government as the laboratory for the tests to be made in St. Louis. The 2 lie side by side, so that the visitor may walk through what the Americans call an "arboretum" and observe all American methods of forestry, and then step across into what the Germans designate as a "forest garden" and learn the German method.

No trees will be cut from either tract. Rather transplanting will be resorted to, and when the exposition opens miniature forests, perfect in every detail, with narrow gravel walks winding in and out, may be seen. Every tree that thrives in the latitude of St. Louis will be represented, and the specimens can be easily designated. Attached to each tree will be a label on which will be stamped the botanical and common names.

Each display will embrace the same number of trees, and they will be practically of the same varieties. Here all similarity ceases. The treatment will accord with the practices in vogue in the respective countries. In the American arboretum the trees will be treated according to the American idea. In the German forest garden will be reproduced, in miniature, the effects that obtain in the forests of the Fatherland, and the story of how the wonderful forests of that country have been preserved through ages, and renewed from time to time, will be told by practical demonstration.

The exhibits will be in charge of the most expert foresters to be found in the 2 countries. Interest will not centre in the exhibits merely because they represent all that is best in the forestry of these countries, but because of the practical demonstrations and tests that will be made every day of the exposition. Trees will be transplanted, and the most approved apparatus for this work will be shown in actual operation; trees also will be pruned and trained, and all implements used will be part of the exhibit.

Furthermore, trees will be inoculated with disease, and when the disease is fully developed the most approved treatment will be accorded. Careful data will be kept on all such experiments, and the results will be made known, together with a full description of the treatment, in order that the preservation of the forests may be accomplished.

Forests have deadly foes in the insect world. Collections of the insect enemies will be gathered and kept carefully isolated. On occasions best adapted to experiments that will reveal all the effects of the destroying powers of the insect, and the efficacy of the treatment to be given, the insects will be released and permitted to attack the trees. Then sprays, washes, and other treatments will be resorted to. Some valuable experiments will be made every day, and full details may be had of the process and results.

Much rivalry exists between the German and American foresters, and each class will do all in its power to prove that its methods are the best.

The intelligent readers of RECREATION will readily perceive the ridiculousness of the proposition, knowing that forestry, or tree growing, is a matter of time, which can in no way be compressed into weeks or months.—EDITOR.

PRESERVE ADIRONDACK FORESTS.

The public in general understands that the forests are being rapidly depleted, and the sentiment in favor of preserving the Adirondack forests is strong throughout the State. In fact the 5 governors preceding Odell were all in favor of protecting the forests and acquiring lands for the State; and his action in taking issue against the sentiment of a majority of the people of this State is not endearing him to them, especially the sportsmen, for it is generally conceded that the true sportsman has a better idea of and more regard for the forests than politicians have. It is to be hoped that

without much further delay, authority will be given to buy for the State all the land available in the Adirondacks before more of it is secured by the lumbermen.

To give an idea of the destruction that is going on, I will note that a gentleman from this city is reported to have recently bought 60,000 cords of pulp wood for one papermaking company, 10,000 cords of which are to be delivered for Watertown paper mills. If this wood were in a pile one cord high, this quantity would extend 16 miles. I am informed that there are 50,000 cords now at Dexter, Jefferson county, both in the stream and on the bank, and that one pile on the bank represents 13,000 cords.

It is reported that 9 successful novels recently published in the United States had a total sale of 1,600,000 copies. Since the average weight of each book sold was probably 20 ounces, calculation will prove that these 1,600,000 books contained 2,000,000 pounds of paper.

As trees 4 inches in diameter are cut for pulp, a paper manufacturer observes that the average spruce tree yields a little less than half a cord of wood, which is equivalent to about 500 pounds of paper. In other words, these 9 novels required 4,000 trees, and they form but a small portion of the fiction so eagerly read by the American public.

S. E. Stanton, Watertown, N. Y.

This is only one of several instances in which Governor Odell has shown a hostile attitude toward the game and the forests of this State. The sportsmen, and that means the friends of the Adirondack forests, will have another reckoning with Odell at the ballot box, if he should ever run for office again.—EDITOR.

SOME PHILADELPHIA TREE HOGS.

Frightened at the prospect of an overstocked market and a serious financial loss, the Christmas tree syndicate here late this afternoon decided on the destruction of 30 carloads of spruces and pines that were lying in the West Philadelphia yards of the Pennsylvania Railroad, thereby cutting the supply in half.

At dusk this evening a locomotive started out of the switchyard with 15 cars. These were run to a dump some distance from the city, where the 15 loads of trees were saturated with oil and a torch was put to them. A second string of cars loaded with trees, was afterward taken to the same place.

Altogether 4,000 trees were burned between dusk and midnight. There are now in Philadelphia about 3,000 trees to supply a normal demand for 5,000.—Philadelphia paper.

I should like to call the attention of all true sportsmen to this outrage. Such ruthless waste of pine and spruce trees, which are among our most beautiful conifers, is scandalous. These syndicate men are worse than game hogs.

RECREATION is doing a great good by roasting such brutes.

J. N. Farson, Plainfield, N. J.

The object in burning these trees was, of course, to compel people to pay 3 or 4 times as much for their Christmas trees as they would have had to pay if this generous supply had remained in the market. In other words this Christmas tree syndicate destroyed 4,000 young trees in order to get a chance to rob their customers.

This is the sort of thing that makes anarchists and socialists.

The proper medicine for the tree burners would be a good large dose of whipping post.—EDITOR.

FOREST MANAGEMENT.

Under the direction of A. F. Potter, the United States Bureau of Forestry has begun an examination of the lands withdrawn from public sale in the Northern and Central parts of the State of California, the object being to determine what proportion should be included within permanent forest reserves and what portions excluded; and, in connection with other work to be done by the Bureau of Forestry, in co-operation with the State, to outline a State forest policy. The following points will be especially investigated:

The distribution and character of the forest, with a description of the varieties of trees and brush covers; the condition of the forest, to what extent devastated areas are being again forested by natural production, what protection is needed and where planting will be necessary to reforest the lands; the extent of damages by fire, its usual causes and the season at which fires are most likely to occur; the extent of lumbering in the past and at present and its effect on the forest; the effect which the creation of forest reserves will have on lumbering; the quantity of merchantable timber and its accessibility to market; the nature and relative importance of industries in the proposed forest reserves and adjacent regions and their dependence on the timber lands and water supply; the effect of the forest and brush cover on the water flow; the location, size, importance and industries of towns and settlements within or near the proposed forest reserves; the means of transportation, roads and railroads; the extent of mineral lands and mining and the demand on the timber by this industry; the demand on the range for pasturing live stock; to what extent the prosperity of local residents depends on the live stock industry; the number and kind of live stock being pastured; the length of season; the condition of range; where grazing should be allowed and where restricted.—Exchange.

My business prevents my taking many trips; but RECREATION well read is almost as good as really getting into the woods.

Karl O. Balch, Lunenburg, Vt.

In 18 years I have taken a great many papers and magazines, but find none equal to RECREATION.

S. S. Dice, Ligonier, Pa.

I take several other magazines, but RECREATION beats them all.

Geo. F. Norris, Torrington, Conn.

PURE AND IMPURE FOODS.

Edited by C. F. LANGWORTHY, PH.D.

Author of "On Citraconic, Itaconic and Mesaconic Acids," "Fish as Food," etc.

"What a Man Eats He Is."

DIET FOR THE AGED.

In his recently published "Diet in Relation to Age and Activity," Sir Henry Thompson, who at the time of writing it was in his 82d year, gives, on the basis of experience, excellent advice regarding the food best suited to old age. Some of his statements follow:

"I advise more emphatically than ever, simplicity in diet. Not only should the quantity of food taken be gradually diminished in proportion to decreased activity of body and mind, but not more than 2 or 3 different forms of food should be served at any one meal. There is no objection to variety in the choice of provisions. On the contrary, it is neither necessary or desirable to make use of the same kinds of aliment every day. Moreover, these necessarily vary with the season of the year, both in the animal and vegetable kingdoms. From the profusion which nature gives should be selected those which each individual, at the time of life supposed, has discovered, by personal experience or otherwise, to agree best with his constitution. I say advisedly 'with his constitution,' rather than with his stomach. There are notable examples of the stomach easily digesting materials which are highly injurious to the constitution. For instance, many persons readily digest and assimilate fatty or fat-forming elements in their food and become unduly corpulent in consequence. Such a condition should be avoided as most undesirable in advancing years, and as one of the most certain to prevent longevity, and give rise to complaints which entail discomfort and even suffering during later life. No one should permit himself to become the subject of obesity in advancing years; and almost invariably it is his own fault if he does. The prevention may be insured by largely reducing the use of fatty foods, as fat of meat, bacon, ham, etc.; by renouncing all pastry which contains that element largely; also cream, and much milk, as well as all starchy matter, which abounds in the potato and other farinaceous products of the vegetable kingdom; and especially in those combinations so popular and so universally met with at the family table, as rice, sago, tapioca and corn-flour puddings, made with milk and eggs, of which the yolks contain much fat, the whole being sweetened with

sugar and making a combination of carbohydrates of the most fattening kind. Admirable for childhood and middle life, and afterward, during the years of maximum activity, they must be completely renounced if corpulence appears in later life. In this condition also large quantities of liquid are undesirable at meals; indeed, no liquid should be taken during the meal, and only in moderate quantity soon after it. If any wine is taken it should be a light Moselle, while ale or beer in any form is wholly inadmissible. Pure water alone is probably the best, or as used in tea, coffee, and cocoa-nibs.

"Respecting the act of eating, itself, it is desirable to add a few words. The process of masticating affects the food in 2 ways during the period it is retained in the mouth, before the act of swallowing it takes place.

"First, it is essential that all food whether formed of meat, fish, bread, or vegetables, should be thoroughly divided into minute fragments by the teeth, so that the animal portion may be properly subjected to the action of the gastric juice when it arrives at the stomach; also because for all starchy foods already spoken of as the carbohydrates, complete and prolonged mastication is, if possible, even more necessary, although they are generally soft and easily swallowed. The act of mastication excites a constant flow of saliva into the mouth. This fluid contains a specific chemical agent known as "ptyalin," by means of which the actual digestion of all the starchy products is performed in the mouth. These starchy products are completely insoluble in water, but saliva converts them into glucose, which is quite soluble; and on being swallowed they can therefore be absorbed as soon as they reach the stomach. This fact should never be forgotten; that the mouth is the cavity in which that large portion of our food which consists of bread, farinaceous foods and vegetable tubers ought to be digested by means of mastication and insalivation, that is, thorough mixing with the saliva. If, however, this process be neglected, as unhappily is too often the case, the stomach, which is capable of digesting animal food only, of course including milk and eggs, and has no power whatever to digest starchy matters, is liable to

be deranged by the presence of much undigested bread and pudding. These, if not well masticated, must be detained there until the animal products are dissolved, when the entire contents reach the small intestine (duodenum), where digestion of the starchy matters is effected by contact with the pancreatic juice which renders them soluble and capable of being absorbed as nourishment to the system."

SOME COOKING EXPERIMENTS.

Scientific studies of the changes brought about in food by cooking, the effect of different methods of cooking on the composition and digestibility of food, the losses in weight in cooking, and similar topics, are not numerous, and especial interest attaches therefore to the recent work of Richter, a German investigator.

He was himself the subject of digestion experiments, each of 2 days' duration, in which about 600 grams of cooked peas were eaten each day. In the first test the peas were cooked to a purée in distilled water, and in the second in hard water, and in both cases the material was passed through a sieve. The peas cooked in distilled water were better borne and caused less digestive disturbance than the others. When cooked in distilled water the peas had the following coefficients of digestibility: Dry matter, 92.86; protein, 89.84; fat, 87.56; and ash, 81.09. When the peas were cooked in hard water the coefficients were as follows: Dry matter, 91.08; protein, 83.40; fat, 58.92; and ash, 51.78. The observed inferior assimilation of peas cooked in hard water was attributed in part to the formation of alkaline earth albuminates and alkaline earth soaps which are not broken down by cooking or by the digestive juices, and in part to digestive disturbances caused by the alkaline earth salts, especially magnesium chloride present in the hard water used.

In an article recently published in a Belgian journal, Carpiaux reports some studies of the composition of eggs and the losses in weight in cooking, selecting for his tests the eggs of a number of breeds of hens. In every case the eggs were cooked for an hour in a steam bath. It is stated that the loss in weight during cooking was insignificant, ranging from 0.03 to 0.1 gram per egg. As was to be expected, the weight of the eggs varied within rather wide limits, the Braekel eggs weighing on an average 66.45 grams each, being the heaviest, and the eggs of bantams (Barbu d'Anvers), weighing 29.55 grams, being the smallest. It was found that the proportion of yolk is greatest with the eggs of bantams and, generally speaking, with the eggs of the breeds best suited for fattening. Both the

yolk and the white of the eggs of the different breeds varied somewhat in composition, and the author discusses the differences at some length, attention being called especially to the lecithin content of the yolk and its importance in nutrition.

ADAPTING FOOD TO BODILY NEEDS.

All persons are alike in that they must have protein for the building and repair of the bodily machine and fuel ingredients for warmth and work, but individuals differ in the quantities and proportions they require, and even among those in good health there are many who are obliged to avoid certain kinds of food, while invalids and people with weak digestion must often have special diet.

For people in good health and with good digestion 2 important rules are to be observed in the regulation of the diet. The first is to choose the things which agree with them, and to avoid those which they can not digest and assimilate without harm. The second is to use such kinds and quantities of food as will supply all the nutrients the body needs and at the same time will not burden it with superfluous material to be disposed of at the cost of health and strength.

For guidance in this selection, Nature provides us with instinct, taste and experience. Physiological chemistry adds to these the knowledge, still new and far from adequate, of the composition of food and the laws of nutrition. In our actual practice of eating we are apt to be influenced too much by taste; that is, by the dictates of the palate. We are prone to let natural instinct be overruled by acquired appetite, and we neglect the teachings of experience. We need to observe our diet and its effects more carefully and to regulate appetite by reason. In doing this we may be greatly aided by the knowledge of what our food contains and how it serves its purpose in nutrition.

Though there may be differences among abnormal persons, for the great majority of people in good health the ordinary food materials—meats, fish, eggs, milk, butter, cheese, sugar, flour, meal, and vegetables—make a fitting diet, and the main question is to use them in the kinds and proportions fitted to the actual needs of the body.

When more food is eaten than is needed, or when articles difficult of digestion are taken, the digestive organs are overtaxed, if not positively injured, and much energy is thus wasted which might have been turned to better account. The evils of over-eating may not be felt at once, but sooner or later they are sure to appear; perhaps in excessive fatty tissue, perhaps in general debility, perhaps in actual disease.

BOOK NOTICES.

PIONEER DAYS IN OHIO.

Dr. Zane Grey has written what I regard as one of the strongest and most thrilling historical novels of the day. It deals with the history of the first settlement on the Ohio river, where Wheeling now stands, and recounts vividly the perils, the hardships and the privations of the sturdy pioneers who hewed out a hole in the forest, built a block house and defended it, time and again, with their lives. The last battle of the Revolution was fought on that ground, and had it proved a victory instead of a defeat for the British arms, the struggle would no doubt have lasted several years longer.

Dr. Grey is a direct descendant of Colonel Zane who built Fort Henry, and who for several years commanded the troops stationed there. The heroine of the story is Betty Zane, a sister of Colonel Zane, and the author tells in a most stirring way how that young girl ran through a hail storm of British bullets and Indian arrows, a distance of some 200 yards, to the magazine, and brought a keg of powder to the defenders of the Fort, reaching them at a moment when the last charges they had were being fired from their guns. But for the heroic bravery of this girl, the Fort would have been compelled to capitulate within another hour, and a victory for the British at that point would have meant an entire change in the tide of the war.

There is just enough of a love story running through the book to hold the sympathy and to rivet the attention of the reader to the more serious and tragic phases of the drama.

Among the other historical characters who figure in this story are Simon and James Girty, Jonathan and Isaac Zane, Lew Wetzel, and Wingenund, Thunder Cloud, Logan, and other Indian chiefs.

Wetzel was a friend and companion of Daniel Boone, and next to him was probably the greatest and most successful Indian hunter that ever trod the virgin soil of the middle West.

Dr. Grey is himself a big game hunter and a careful student of the science of rifle shooting, and is thus enabled to analyze the characters of such men and to describe in detail their wonderful feats of marksmanship in a manner that few other writers of this day could. There is not a man living, who knows the power and the deadly accuracy of the old Kentucky rifle, who will not hold his breath while reading some of the accounts of Wetzel's wonderful feats of marksmanship.

Here is an extract that will give the reader an idea of the treat in store for him when he gets a copy of Dr. Grey's book:

Wetzel's keen gaze, as he looked from left to right, took in every detail of the camp. He was almost in the village. A tepee stood not 20 feet from his hiding place. He could have tossed a stone in the midst of squaws, and braves, and chiefs. The main body of Indians was in the center of the camp. The British were lined up farther on. Both Indians and soldiers were resting on their arms and waiting. Suddenly Wetzel started and his heart leaped. Under a maple tree not more than 150 yards' distant, stood 4 men in earnest consultation. One was an Indian. Wetzel recognized the fierce, stern face, the haughty, erect figure. He knew that long, trailing war bonnet. It could have adorned the head of but one chief—Wingenund, the sachem of the Delawares. A British officer, girdled and epauletted, stood next to Wingenund. Simon Girty, the renegade, and Miller, the traitor, completed the group.

Wetzel sank to his knees. The perspiration poured from his face. The mighty hunter trembled, but it was from eagerness. Was not Girty, the white savage, the bane of the poor settlers, within range of a weapon that never failed? Was not the murderous chieftain, who had once whipped and tortured Wetzel, and who had burned Crawford alive, there in plain sight? Wetzel reveled a moment in fiendish glee. He passed his hands tenderly over the long barrel of his rifle. In that moment as never before he gloried in his power—a power which enabled him to put a bullet in the eye of a squirrel at the distance these men were from him. But only for an instant did the hunter yield to this feeling. He knew too well the value of time and opportunity.

He rose again to his feet and peered out from under the shading laurel branches. As he did so the dark face of Miller turned full toward him. A tremor, like the intense thrill of a tiger when about to spring, ran over Wetzel's frame. In his mad delight at being within rifle shot of his great Indian foe, Wetzel had forgotten the man he had trailed for 2 days. He had forgotten Miller. He had only one shot, and Betty was to be avenged. He gritted his teeth. The Delaware chief was as safe as though he were a thousand miles away. This opportunity for which Wetzel had

waited so many years, and the successful issue of which would have gone so far toward the fulfillment of a life's purpose, was worse than useless. A great temptation assailed the hunter.

Wetzel's face was white when he raised the rifle; his dark eye, gleaming vengefully, glanced along the barrel. The little bead on the front sight first covered the British officer, and then the broad breast of Girty. It moved reluctantly and searched out the heart of Wingenund, where it lingered for a fleeting instant. At last it rested on the swarthy face of Miller.

"For Betty," muttered the hunter, between his clenched teeth as he pressed the trigger.

The spiteful report awoke a thousand echoes. When the shot broke the stillness Miller was talking and gesticulating. His hand dropped inertly; he stood a second, his head slowly bowing and his body swaying perceptibly. Then he plunged forward like a log, his face striking the sand. He never moved again. He was dead even before he struck the ground.

Blank silence followed this tragic shock. Wingenund, a cruel and relentless Indian, but never a traitor, pointed to the small bloody hole in the middle of Miller's fore-

head, and then nodded his head solemnly. The wondering Indians stood aghast. Then with loud yells the braves went for the cornfield; they searched the laurel bushes; but they discovered only moccasin prints in the sand, and a puff of white smoke drifting away on the summer breeze.

I predict for this book a sale of 100,000 copies.

"Betty Zane" is published by the Charles Francis Press, of 30 West 13th Street, New York, and sells at \$1.50. In ordering please mention RECREATION.

Charles A. Sterling, Broadwater, Virginia, has published a small book, giving a history of Hog island, on the coast of Virginia. The object of the book is to interest sportsmen in a plan to organize a club and lease the shooting privileges on this island. It is said to be a popular resort for ducks, geese and brant, and I am informed the settlers on the island are nearly all willing to lease the shooting rights on their lands, at nominal prices. Anyone interested in such a proposition would do well to communicate with Mr. Sterling. The book sells at 25 cents.

PUBLISHER'S NOTES.

EXPERT ENDORSEMENT.

U. S. Commission of Fish and Fisheries,
Station at Viento, Oregon.

J. R. Buckelew,
111 Chambers St., N. Y.

Dear Sir:

I have tried the Collan Oil on 2 pairs of shoes, with better results than I expected. On my heavy hunting shoes, which I wear when engaged on work along the rivers and in the wet, I put a heavy coat of the oil, or rather 3 heavy coats. First I applied it to them thoroughly, then allowed them to dry; after which I coated them in the same manner twice again. On all occasions I was careful to get the oil well into all the seams, along the top and sides of the sole and on the bottom of the sole. Since its application 2 weeks ago I have had occasion to wade almost to the tops of the shoes in the Columbia and Little White Salmon rivers, and have worn the shoes through mud while it was raining hard. During this time they have not leaked at all, and have remained soft and pliable; so I can say the use of the oil is gratifying,

for I have hitherto been forced to wear rubber boots on almost every occasion.

Truly yours,
(Signed) J. N. Wisner.

TWO HANDSOME CALENDARS.

The Horton Manufacturing Company, Bristol, Conn., is sending out a beautiful calendar for 1904. It represents a 20th century girl in the act of stepping out of a birch bark canoe on the shore of a river, holding in one hand a 5 pound black bass, which she is supposed to have just taken from the water, and in the other hand one of the famous Bristol steel rods. The work is beautifully lithographed in natural colors, and a glance at the picture will set the nerves of any angler tingling. Every lover of the woods and the waters should have a copy of this calendar.

Another beautiful work of art in the calendar line comes from the Harrington & Richardson Arms Co., makers of the well known revolvers and shot guns, Worcester, Mass. The picture in this case represents a typical American beauty, with golden hair,

arrayed in evening costume and lavishly decorated with violets. The color scheme is superb, and there is sure to be a great demand for this calendar. Any reader of *RECREATION* who will write the company, mentioning this magazine, can get a copy of the calendar free—while the supply lasts.

GAME ALONG THE GRAND TRUNK.

In a recent conversation with an officer of the Grand Trunk Railway, he stated that the deer and moose hunting season in the Province of Ontario for November last was even better than previous seasons, as returns from the express companies and other channels demonstrate. The Canadian Express company carried a total of 2,950 deer, weighing 309,101 pounds. This number shows an increase of 682 carcasses over last season. These figures, of course, do not give any idea of the total number of animals killed, as the major portion of them are carried home by other conveyances, and many of the hunters bring home the heads only as trophies. It is estimated that about 10,000 deer and 100 moose were killed during the 15 days open season in the Highlands of Ontario. It has also been noticed that many more sportsmen from the United States have gone into the hunting regions this year. The grouse and duck shooting has also been good throughout the Highlands, but quail have been more scarce than in past years.

A NEW BUZZACOTT BOOK.

Buzzacott, Racine Junction, Wisconsin, has recently issued a book entitled "The Anglers' Manual." It is scarcely necessary to say more of this than that it is on a par with his Campers' Manual. That is, it gives more information, for a smaller price, than any book I have ever seen. This Anglers' Manual sells at 10 cents a copy, and contains \$10 worth of information, at a conservative estimate. The text is terse and is condensed to a minimum of space. The illustrations, over 200 in number, show nearly every device that fishermen ever have occasion to use. Among these illustrations are accurate portraits of most of the species of game fishes found in this country.

There are many other valuable features in the book, but it is scarcely necessary to enumerate them here. No man or woman who is interested in fishing would ever hesitate to pay 10 cents for a book that tells all about it, and this one does that. In writing for it please mention *RECREATION*.

HISTORY OF GREAT FLOOD.

The Passenger Department of the Chi-

cago & Alton railway has issued a book, entitled "The Flood of 1903," which is one of the most remarkable publications that has ever come to me from any railway company. The book is a pictorial history of the great Mississippi flood, which, as everyone knows, carried away millions of dollars' worth of property, and inflicted untold misery and suffering on thousands of people. Several of the cuts in this book are made on the panoramic plan. They are 4½ inches high by 25 inches long, and show the terrible expanse of water and the fearful loss of property in the most graphic way that these could possibly be portrayed by the camera.

Mr. Charlton is entitled to great credit for the ingenuity and enterprise displayed in this matter, for "The Flood of 1903" is a great book. Any reader of *RECREATION* can get a copy of the book by enclosing 25 cents in postage to Mr. George J. Charlton, G. P. A., C. & A. Railway, Chicago, Ill.

A LESSON IN ADVERTISING

In their 1904 calendar just received, N. W. Ayer & Son have adhered to their popular conception of a business calendar, but have changed the design and coloring. The size is the same, about 14 by 28 inches, with large readable dates, but the clay modeling design printed in sepia tints, gives more prominence to their well known motto, "Keeping everlastingly at it brings success"; not a bad idea for people to have before them throughout the year.

The blank spaces occurring each month contain suggestions on business getting, advertising in general, and N. W. Ayer & Son's methods of advertising in particular, the whole forming an interesting and instructive lesson in productive publicity.

Requests for this calendar addressed to their Philadelphia office, accompanied by 25 cents to cover cost and postage, will be taken care of for the present. Last year the supply lasted barely 10 days.

ONLY ONE CLUB BRAND.

Judge Colt, of the Circuit Court of the United States, District of Massachusetts, deserves the congratulations and thanks of the American people for the broad and sweeping decision rendered Nov. 9, 1903, restraining Adams, Taylor Co., of Boston, Mass., from using the word "Club" in connection with bottled Cocktails. The complainants, G. F. Heublein & Bro., have spent much time and money in introducing the celebrated Club Cocktails, which like all well known and staple articles have been more or less imitated. This decision means not only protection to the maker of the goods, but affords equal protection to the purchaser, and simplifies the matter of

getting what you want and pay for. We trust the courts will continue this good work and protect known and established brands from the piracy to which they so long have been subject.

DISEASES OF DOGS

The Sergeant dog remedies, made by the Polk Miller Drug Co., Richmond, Va., are compounded by a veteran, who all his life has been an owner and lover of fine dogs. He believes in treating these faithful animals as members of the human family; has studied their diseases in every phase; has experimented until now his remedies are known all over the United States as the best on the market. Veterinary surgeons everywhere use them and say of them: "It is no experiment to use Sergeant's dog remedies, for they have become the standard medicines in our practice." If anybody wishes to know anything about dogs, their varieties, their ailments, their treatment, 3 cents postage and a request to Polk Miller Drug Co., Richmond, Va., will bring a handsome free book on dogs.

REVIVAL OF BICYCLE INDUSTRY

The re-issue of the Pope bicycle daily leaf calendar may be considered the opening gun proclaiming the natural and healthful return of bicycling. Col. Albert A. Pope, the founder of our bicycle industries and the pioneer in the good roads movement, is again at the head of the bicycle industry. On the 366 calendar leaves are freshly written lines from the pens of our greatest college presidents, doctors, clergymen, statesmen, and other eminent men and women, all of them enthusiastically supporting bicycling. Half of each leaf is blank for memoranda. This calendar is free at the Pope Manufacturing Company's stores, or any RECREATION reader can obtain it by sending 5 2-cent stamps to the Pope Manufacturing Co., Hartford, Conn., or 143 Sigel Street, Chicago, Ill.

The Malcolm Rifle Telescope Co.,
Syracuse, N. Y.

DEAR SIR: Great credit is due your Company for putting on the market such an excellent telescope rifle sight as the little Rough Rider. I have carried one to the woods 2 seasons for a month each trip. I have used rifles, both large and small bore, since I could hold one, and the use of your hunting 'scope of 3 powers much more than doubles the pleasure I get out of my rifles.

Your A side mounts are all anyone could wish, compact and neat, up and down and sidewise. The Rough Rider 'scope simply makes a rifle of any size complete.

J. D. Berdan, Roselle, N. J.

Benton Robbins, Cassville, Mo., has secured Patent No. 728,302 on a gun barrel protector. This is described as an absorbent sheath, open at one end and closed at the other, with a tightly fitting, closely coiled spring arranged within the sheath, and a plug adapted to screw into the open end of the sheath. A ring is attached to this plug so that a string may be fastened to it and dropped into the barrel. Then the sheath is to be drawn into the barrel and left there.

With all the cleaning devices being manufactured, in the way of wick plugs, oils, sheathes, &c., there will be no excuse hereafter for any man who may carry a dirty gun.

Watkins, N. Y.

D. M. Tuttle Co.,
Canastota, N. Y.

Sirs:

I am much pleased to say that the 18 foot launch, 1½ H. P. motor, bought of you in July last, has proved entirely satisfactory. We often have rough water at this end of Seneca lake, and I have had her in big waves. Was out to-day with a party of 8, and she rode the swells like a duck. The motor works perfectly. In short, we are well pleased and satisfied with the investment and made no mistake in selecting a Tuttle boat.

Respectfully yours,
Edward Hanner.

Sportsmen and others will be interested in the November issue of the Baker Gun Quarterly, published by Baker Gun and Forging Co., Batavia, N. Y. It contains articles on the subject of buck shot and its use in choke bore guns, a system of bookkeeping for the Rose system at tournaments, essays on duck shooting, and other instructive matter, besides full descriptions and prices of the Baker Guns. The Quarterly will be sent free to any address on request. In writing for it please mention RECREATION.

Reading, Pa.

West End Furniture Co.,
Williamsport, Pa.

Dear Sirs:

The gun cabinet you sent arrived safe and it more than meets my expectations. I do not see how any sportsman can be without one.

E. R. Schaeffer.

A. W. Phillips, of Providence, R. I., has received Patent No. 724,931 for an animal trap, intended for the trapping of rats, mice and other small rodents, and which has some good points.

EDITOR'S CORNER.

WHAT AN INDIANA EDITOR SAYS.

Here is more hot stuff "ferninst" the game hogs and the automatic gun. It is from the facile pen of the Editor of the Indianapolis Sentinel.

With these frosty October mornings there comes to the dweller in town and city a desire to get out in the stubble fields with dog and gun; that instinct reasserts itself which centuries of civilization have yet been unable to eradicate; the "call of the wild," the wish to go out and kill something. In all the shooting districts is heard the bang of the shot gun, and soon we shall have the sportsmen back in town, boasting of their prowess and enumerating with gusto the immense number of birds they have been able to slaughter. Among them will, of course, sing loud that most self satisfied and shameless of brutes, the game hog.

It is to protect our birds and animals against this species of swine that all game laws have been enacted, but the game laws only serve to make him more alert and to reduce the competition. He shoots for the pleasure of slaughtering, and his pleasure is increased in direct ratio to the size of his bag. He argues that if a dozen birds make a good day's sport, a hundred would make a better, and a thousand would constitute perfect happiness. His brother, the fish hog, has done his best during the summer to rid our lakes of bass and trout; those he could not use he has thrown away, not back in the water, and now the game hog will emulate his example.

A sturdy crusade against the *Sus americanus venator* has been taken up and is being vigorously prosecuted by G. O. Shields, better known as Coquina, the veteran editor of RECREATION. Those who turn sport into slaughter and the hunting fields into shambles he arraigns by name, and whenever he can he publishes their pictures, a veritable rogues' gallery. Coquina's latest kick is against the automatic gun which is now being introduced by one of the big arms companies. The arm he refers to has already been seen in the form of a revolver, which fires 7 to 10 cartridges in about 2 seconds. The mechanism as applied to a shot gun bids fair to produce a deadly machine for the use of the pot hunter. Mr. Shields describes it as "a gun with a magazine holding

a number of cartridges which may be discharged as fast as a man can pull the trigger. The shooter jumps a bunch of quails, ducks or geese, cocks his gun and fires. The recoil of the first shot throws out the empty shell, throws a new one into the chamber and cocks the gun ready for another shot. From that on, all the shooter has to do is to swing the muzzle of his gun from one bird to another and pull the trigger until the last shot is fired. Pistols built on this plan hold 7 to 10 cartridges, and it is possible to fire all of them in less than 2 seconds. The magazine of an automatic shot gun, holding 6 cartridges, could be emptied as quickly, and if the shooter were an expert, as many of the game butchers are, it would be possible to kill 10 or more birds out of a covey before they could get out of reach."

All the game laws in the world can not hold the game hog, for brutes know no law but that of their own swinish nature; but decent people and true lovers of sport may do their share toward creating such a sentiment against game butchers that their trade will be followed with ever increasing difficulties. It is hardly to be expected that the company which has paid a large amount for a new engine of destruction will be moved by principle to withdraw the gun from the market. It is the brute instinct that must be conquered.

No doubt Mr. Bennett, of the Winchester Co., will also accuse the Editor of the Sentinel of mud slinging, even as he accuses me. But the impartial reader, the real friend of game protection, will hail the Editor of the Sentinel as a stalwart ally in our good work

AN IOWA EDITOR'S OPINION.

Here is a red hot editorial from the Sioux City, Iowa, Journal, of Sunday, November 1st. The man who writes this article is a sportsman and, of course, a gentleman. I commend this wholesome advice to brother editors throughout the country:

November RECREATION directs attention to a new automatic shot gun which has just been placed on the market, and which, if generally adopted by sportsmen, is likely to neutralize all the good effects which have come from recent legislation for protection and preservation of game birds. The new weapon works on the same principle as

the automatic guns used in modern warfare. It is provided with a magazine and is equipped with a contrivance by which the recoil of one shot throws out the first cartridge and automatically replaces it with another. In this way the gun may be fired as rapidly as the holder can pull the trigger, 6 shots in 2 seconds being made possible. Armed with such a weapon a hunter could turn loose on a flock of birds and slaughter the game at will. RECREATION appeals to all true sportsmen to refuse to use the automatic gun and to try to induce the manufacturers to withdraw it from the market. Men who have the best interests of real sport at heart will be quick to see the force of the appeal.

There used to be an idea that the only test of a sportsman's ability was the size of the bag he secured. It was in consequence of this idea that the repeating rifle and repeating shot gun came into vogue. The use of these more destructive weapons brought about 2 important results. They greatly increased the handicap under which the game birds were competing, and they taught the sportsman that big bags were no longer a test of sportsmanship. Generosity and selfishness both played a part in the learning of this lesson. The shooter ascertained that the element of difficulty cut a large share in the enjoyment of game shooting. He found that ease of killing did not furnish an excuse for wholesale slaughter. Moreover, he discovered that, with all sportsmen taking all the birds they could secure, the supply was being so depleted that there was imminent danger of total extinction.

Thus it was that a new code of ethics was established. The better class of sportsmen no longer consider it good form to take everything in sight merely because opportunity is presented. After securing a reasonable quantity of game they prefer to leave some for others. Also they are found in hearty co-operation with the authorities in the enforcement of laws for the protection of game. The game hog and the pot hunter are now equally in disfavor among legitimate sportsmen.

It is to this policy of enlightened selfishness that the argument against the automatic shot gun will appeal. If the new weapon shall come into general use not many open seasons of the present length will be required for the extinction of the limited number of game birds now remaining. If necessary the use of such destructive weapons could be prohibited by law, just as the use of devices for the wholesale slaughter of

game fishes is prohibited. It would be more creditable to sportsmanship, however, if its devotees would of their own accord refuse to countenance the use of the weapon and compel the manufacturers to cease making it because of lack of demand. The automatic gun should be tabooed by every organization of self-respecting sportsmen.

TO PROHIBIT AUTOMATIC AND PUMP GUNS.

When there were no other guns than muzzle loaders in use game was abundant all over this continent. The wild pigeon swarmed through the Southern and Middle States; buffalo and antelope covered the Western plains; the elk and the mule deer were almost congested in the Rocky mountains and in the Cascades; and the river valleys were alive with them far out on the plains.

Then came the breech loading rifle. This made it possible to kill game so fast that it paid men to kill and skin buffalo and other large animals for the market. Soon after the beginning of this commercial slaughter game of all kinds began to decrease in numbers. Closely following the single shot breech loader came the repeating rifle and the breech loading shot gun. Later the repeating shot gun followed, and every man and woman who reads knows the sequel. The wild pigeon and the buffalo are gone. The antelope is nearly extinct. The elk is entirely wiped out of Arizona and New Mexico. There are scarcely more than 50 remaining in Colorado, where 10 years ago they could be counted by thousands. They are cleaned out of Wyoming, Montana and Idaho, except in the vicinity of Yellowstone Park. They are practically extinct in Oregon, though a few stragglers may still be found in the high mountains of that State.

The mule deer is also being rapidly killed off. Twenty years ago the Virginia deer was abundant in Ohio, Indiana, Illinois, Iowa and Kansas, but not a single wild deer could be found in any one of these States to-day. There are not 10 per cent of the deer in Pennsylvania that were there 20 years ago. All this is due to the so-called improvement in hunting rifles.

Birds of all kinds have disappeared rapidly and several important species of game birds are verging on extinction.

In spite of this tragic condition of affairs, we are now confronted with an automatic repeating shot gun. It is generally conceded that no decent sportsman will use one, but there are thousands of game hogs who will use them if permitted. Nearly all the market hunters now use pump guns. They will discard them and buy automatic guns, because they can kill more game

with them. These men used swivel guns, and 4 bore and 8 bore shoulder guns until stopped by law. Let us now bring them back again by law, to the double barrel gun of 10 bore or smaller.

GAME LAW BREAKERS CONVICTED.

State Game Protector, J. E. Overton, Port Jefferson, N. Y., has just completed a successful year's work in the enforcement of the game and fish laws, and in punishing law breakers. I have had occasion to report several cases to him during the year, which have been brought to my attention, and which for various reasons the League could not prosecute. Mr. Overton has followed all these to a finish, and has been successful in convicting several of the men in question.

Here are some extracts from his report to the Commission at Albany:

Rufus Morris, netting in Pelham Bay, fined	\$25
Andrew Joslin and Frank Cegal, killing deer out of season.....	100
H. V. Schmeelk, taking oysters illegally	50
Haight and Wright, offering gulls for sale	25
John Minugh & Co., selling pike and pickerel out of season and without license	125
Carl J. Recknagle, having Bald Eagle in possession	35
Flint Smith, killing bittern, sentence suspended	—
John F. Nagel, Ed. Bedell, Benj. Churchill and Clifford Clark, shooting ducks from launch.....	20
Arthur Nolan, Geo. Nolan and Frank Bennett, same offense	45
Wm. L. Young and Albert Wend, same offense	30
Ferdinand Downs, same offense	25
Max Single, shooting at a deer on protected grounds	10

Mr. Overton has several other cases pending in the courts, and altogether he has made an excellent record for himself.—
EDITOR.

ANOTHER WESTERN EDITOR CONDEMNST IT.

An automatic shot gun is the latest alleged improvement in the way of fire arms. The Winchester Arms company is about to manufacture a shot gun which any decent and self respecting sportsman ought to be ashamed to use. RECREATION, for November, describes this automatic gun as follows:

"A gun with a magazine holding a number of cartridges which may be discharged as fast as a man can pull the trigger. The shooter jumps a bunch of quails, ducks or geese, cocks his gun and fires. The recoil of the first shot throws out the empty shell, and throws a new one into the chamber and cocks the gun, ready for another

shot. From that on, all the shooter has to do is to swing the muzzle of his gun from one bird to another and pull the trigger until the last shot is fired. Pistols built on this plan hold 7 to 10 cartridges, and it is possible to fire all of them in less than 2 seconds. The magazine of an automatic shot gun, holding 6 cartridges, could be emptied as quickly, and if the shooter were an expert, as many of the game butchers are, it would be possible to kill 10 or more birds out of a covey before they could get out of reach."

Laws have been passed in all the States and in all parts of the civilized world for the protection of game. The Winchester automatic shot gun is designed to work unwarranted butchery among birds and small game. A sportsman could not pride himself on his ability as a gunner if he went duck hunting with one of these repeaters. The most stringent game laws in the world would be ineffective to preserve the species of wild birds that remain in this country if the use of these automatic guns became general. A sentiment ought to be aroused against the use of such a gun strong enough to discourage the gun makers from placing it on the market. No self respecting hunter would ever use one.—Tacoma, Wash., Daily News.

The practice of using postage stamps for small remittances in the mails has grown to enormous proportions. The result is that the Department loses heavily, not only because of improper sales by postmasters for that purpose, thereby increasing their compensation wrongfully, but in imposing on postoffices, especially in the large cities, the labor of handling mail matter the revenues from which are derived by other postoffices. It encourages trafficking in postage stamps, and this encourages the robbery of postoffices. Many plans have been proposed for obviating this evil, but none which have come to my attention equal in simplicity, effectiveness and efficiency, the post check proposition. With such a simple means of making remittances, merchants would soon be compelled to refuse postage stamps as currency. The postage stamp would then lose its value for the purpose of remittance. This system of transmitting money in the mails should be authorized, at least in an experimental way. I hope readers of RECREATION may see fit to write their Congressman urging this.

I frequently get a partial description of some bird, with a request for identification. I am always glad to give information of any kind, to any reader of RECREATION; but it is difficult to identify a bird without a complete description of it. In fact it is better to have the skin of the bird; or at least the head, wings and tail. I do not mean by this to encourage the killing of birds for the mere sake of finding out what they are; but if you kill a bird and then want to know what it is, it would be well to skin it carefully, so it can be mounted, and then if no one in your vicinity can identify it send me the skin and I will return it to you with the information desired.

Schlitz Beer

Receives World's Highest Endorsement

European government scientist awards Schlitz the highest honor.

From Weihenstephan, Bavaria, the most renowned school of brewing in the world, comes this triumph for Schlitz.

The Beer That Made Milwaukee Famous pronounced best American Beer by the Bavarian Government's famous scientist, Prof. Dr. Hans Vogel, Director of the Scientific Station for the Art of Brewing, subventioned by the Royal Bavarian Government. Bavaria is the cradle of the art of brewing.

SCIENTIFIC STATION FOR THE ART OF BREWING
WEIHENSTEPHAN, NEAR FREISING

(Subventioned by the Royal Bavarian Gov't)

PROF. DR. HANS VOGEL,
ACADEMICAL DIRECTOR

WEIHENSTEPHAN, Nov. 22, 1903.

Schlitz Brewing Co., Milwaukee, U. S. A.

Through the courtesy of Commerzeinrath (Counsellor of Commerce) Dr. Datterer, I have received several bottles of your beer. I have not only partaken of same, but have also made a searching chemical analysis, the result of which I enclose. The analysis, as a matter of course, can give no idea of an important feature—the flavor of the beer. I frequently receive samples of American beers for analyzation, but I can truthfully say without flattering that I never drank a better American beer than yours. The beer tasted full (round) and fresh, and no trace of the usual disagreeable pasteurization flavor was discernible. Once more permit me to express my recognition. Very respectfully,

HANS VOGEL.



The Beer That Made Milwaukee Famous!

LIVER-EATING JOHNSON.

R. H.

John Johnson, of Montana, is the modest name of the man who is better known to fame as Liver-Eating Johnson. I first met him in the '60's. He gained his sanguinary title in the stockades on the Musselshell, where for many weeks he, in company with Crow Davis, Jesse Mabbitt and a few others, kept the Indians at bay and almost every day sent one or more of them to join the other good Indians. Even before that time Johnson was known as a fearless scout and Indian fighter, a good hunter and a skilful trapper. He was invariably cool, even in the greatest danger; and though fearless he was never reckless. Even in his old age Johnson had a wonderful physique. He was gray haired, over 6 feet tall, weighed about 270 pounds, wore number 12 shoes and had hands the size of average hams. His voice gave forth fog horn tones, and over his expressionless face no smile was ever seen to flit, but in his eyes the close observer could notice an almost perpetual twinkle. It was his delight to have around him a circle of tenderfeet who hung spellbound on his blood curdling tales. On these occasions he showed a strong aversion to the truth, and seldom allowed it to obtrude. A few years ago I heard him tell the following:

"It makes me tired to hear people say there is any danger or excitement on the ocean. I sailed all over the world when I was a kid, just looking for tough times, and couldn't find them. I was shipwrecked 6 times, but there wasn't any excitement about that. I only floated around a little for a few weeks on a leaky raft, seeing nothing but sky and water. The only lively time I had was when I jumped into the loop of a lariat and towed a raft with 7 men and 8 women aboard into Charleston harbor, a little swim of about 385 miles.

"But I never could find any real excitement on the ocean, so I came out to the mountains to see if I could kick up some among the Indians. Now, you folks might not believe it, but I did find some with the Indians, wounded bears, cloud bursts, snow slides and that kind of cattle. After prospecting 10 years, Wild Cat Bill, Flap-Jack Dick, Sour Dough Ike and I made a big cleanup in Boomerang gulch and dissolved partnership. Bill struck out for the Whoop Up country, Dick and Ike loafed around until they were taken in by the Indians, while I ran down the trail to Boston, to take another look at the ocean and see if it was all there. I tried to put up at a place they call Harvard, but the boys were sassy and wouldn't let me camp there. Guess old man Harvard was out at the time. I went down to Mr. Parker's tavern and hadn't taken a dozen cocktails when I met a man who had sailed with me when he was a kid. His name was Ebenezer Higinbotham. I had taught him all about navi-

gating the trails and he kept right on until he became captain of a whaler. He told me the ship was hitched somewhere outside and begged me to go with him hunting whales. I studied over this through 20 cocktails, and then made up my mind to go.

"We struck up North, rubbed out all the lines of longitude and shortitude, and many a whale did we sight. I wanted to set a bear trap or 2 for them, but Eb laughed at me. One day the fellow that was roosting up among the lariats yelled out, "A whale, a whale!" as if it was going up there to bite him. The men got 2 boats over the side, and rowed away as if a lot of Apaches were hot on their trail. The captain watched them through a glass. I never use a glass except for whiskey and then only when I can't get at the bottle. The fellows rowed out and stuck 2 pike poles into that whale. He just swung his rudder round, sort of careless like, and smashed one boat into splinters. Then he opened his mouth and chewed the other boat up in one chew. The men swam around a little and finally got into a boat the captain sent out to them.

At last I says, "Lower the biggest Mackinaw you have, put in your stoutest and longest lariat, my express rifle, and the whiskey bottle. Lively now!" They jumped to obey orders. I got into the boat, struck out for that whale, and got up pretty close to him. You ought to have seen the look on that critter's face! He acted as if he had never been in a school of whales. I swung the lariat a time or 2 about my head and let drive. It caught him in the upper jaw and tight over the nose. I hauled in the slack and fastened the end to my belt. Why didn't he dive? How could he? Didn't I just tell you I was rowing? I kept up a lively gait and the whale just laid back on the lariat; but at last he saw it was all up with him, so he came along as gentle as a calf. I got ashore and snubbed him to a tree. Then I rowed out, and putting up my rifle, shot him through the brain. I didn't want to risk a shoulder shot, as he was so deep in the water. Then the captain and crew came to tow the varmint to the ship.

The captain cried when I told him I was not going back with him, but was going to row down to Boston, some 4,500 miles by the nearest cut off. Then he knew what I wanted the whiskey and crackers for. He said anyway I must share in the proceeds. I told him I only wanted as much as the other men got; no more. Three weeks after I got to Boston a banker sent me word I had to my credit in gold, \$30,000—my share of the whale's lard. Big whale? Say, Mister! Do I look like a man who would tackle a little one?"

"Miss Passé was kissed in a dark hallway the other night."

"Is that so?"

"Yes, and there hasn't been a light in her house since."—Life.

THE EQUITABLE



J.W.ALEXANDER
PRESIDENT

J.H.HYDE
VICE PRESIDENT

HENRY B HYDE
FOUNDER.

ONLY A FEW FLAKES

at a time — but what an
accumulation all together.

Only a few dollars at a time
invested in an Endowment
Policy in the Equitable — but
what an accumulation for
your maturer years.

And while the money is ac-
cumulating for you your
family is protected.

Vacancies for men of character to act as representatives
Apply to GAGE E. TARBELL, 2nd Vice President

For full information fill out this coupon, or write

THE EQUITABLE LIFE ASSURANCE SOCIETY of the
United States, 120 Broadway, New York. Dept. No. 16

Please send me information regarding an Endowment for
\$.....if issued at.....years of age.

Name.....

Address.....



AMATEUR PHOTOGRAPHY.

"For sport the lens is better than the gun."

I wish to make this department of the utmost use to amateurs. I shall, therefore, be glad to answer any questions and to print any items sent me by practical amateurs relating to their experience in photography.

THE WINNERS.

RECREATION'S 8th annual photo competition closed November 30, and is now a matter of history. Nearly 500 entries were made, and among these were over 100 high class pictures. As usual, the judges had great difficulty in deciding which of these should be awarded the first prize, which should have second, third, etc.; but after careful deliberation they finally placed the prizes as follows:

1st prize, Rail Shooting on the Susquehanna, U. C. Wanner.

2d prize, At Home in the Rushes, J. E. Stanley.

3d, Bob White by Flashlight, S. L. Bee-
gle.

4th, The Fisherman Who is Always
Lucky, Chas. Vandervelde.

5th, The Golf Girl, George Worth.

6th, A Good Pair to Draw to, E. F. Pope.

7th, Don't Bother Me, I'm Busy, A. S.
Goss.

8th, I'm Trying to Look Pleasant, Flor-
ence Molique.

9th, Saved, by Gum! G. Wilbur Wood.

10th, Three Black Crows Sat on a Tree,
R. H. Beebe.

Special prize for best photo of a live wild
animal, On a Newfoundland Marsh, Mrs.
W. B. Lee.

11th, The Skater, Rud Engelmann.

12th, The Army and Navy, Chester A.
Reed.

13th, At Breakfast, John H. Fisher, Jr.

14th, Yes, Sir, S. G. Jameson.

15th, A Good Catch, George Hartmann.

16th, A Morning Snooze, J. E. Tylor.

17th, Pin Cushions, Wallace J. Bundy.

18th, Good Bye to Trains for 30 Days,
Thos. C. Martindale.

19th, Right on Them, Wm. H. Fisher.

20th, Defiance, Geo. W. Fisk, Jr.

21st, Humming Bird, Geo. J. Newgarden.

22d, Caught Once More, B. T. Boies.

23d, A Flying Leap, Chas. F. Tess.

24th, American Goshawk, C. V. Oden.

25th, A Cozy Retreat, name of photog-
rapher unknown.

26th, The Foster Mother, F. Spittal.

27th, The Eagle's Gibraltar, A. J. Brun-
quist.

28th, Canada Goose, Dr. Edward A.
French.

29th, Antelope in the Bad Lands, Mrs. T.
F. Roberts.

30th, Stepping High, E. F. Cowgill.

31st, A Corking Good Story, R. C. W.
Lett.

32d, Goose Shooting on the Big Sioux,
E. W. Edgington.

33d, Blue Heron in His Favorite Haunt,
J. P. Hambly.

34th, Young Night Hawk, W. Stark.

35th, Ruffed Grouse, Fred L. Libby.

36th, Pine Grosbeaks, Robert Stevenson.

37th, Honeysuckle Camp, W. D. Gay.

38th, Family of Screech Owls, O. J. Ste-
venson.

39th, Young Robins, H. C. Markman.

40th, Chicken Thief, A. J. Lewis.

41st, Feeding the Baby, J. B. Parker.

42d, A Sun Bath, F. S. Andrus.

43d, Great Blue Heron, Frank C. Nash.

44th, Making Friends, G. N. Waterbury,
Jr.

45th, Coon, Homer W. Squier.

46th, Hawk Eggs, Geo. C. H. Warner.

47th, Patching the Canoe, W. E. Lurchin.

48th, Round the Camp Fire, Leonard F.
Weston.

49th, The Angler, S. G. Jameson.

50th, Grouse, F. J. Angier.

51st, A Moonlight Sail, Albert Haanstad.

52d, I'm Busy, C. M. Whitney.

53d, Nest and Eggs of Ruffed Grouse, H.
H. Fraser.

54th, Midwinter Recreation, Chas. Mars-
den.

The following were highly commended:

The Coon Wins; Snake in Full Retreat;
Something Doing; Stick a Tater in His
Mouth; Rescued; The Reptile Strikes; A
Black Climber prepares an Attack; Mutton
Up and Mutton Down, and a River Shore
Feast, J. E. Tylor.

Posing and Top Line Work, U. C.
Wanner.

The Early Bird; Trying Their Muscle;
Who Wants Me? R. H. Beebe.

At Bay and Fly Casting on Williamson
River, Oregon, E. C. Cross.

Confidence and a High Jump, Chester A.
Reed.

A Sour Old Customer, Wm. H. Fisher.

A Good Start and the Turkey Hunters,
Frank H. Shaw.

Defending His Castle, A. J. Brunquist.

The Ski Girl, George Worth.

Turtles, James E. Stanley, Jr.

A Faithful Mother, J. B. Parker.

Woodchuck Prospecting, F. S. Andrus.

A Bad Case of Snakes, C. L. Fulstone.

The Skaters and the Old Oaken Bucket,
C. Vandervelde.

The judges were Joseph T. Keiley,
lawyer and expert amateur photographer,
and Frank P. Dwyer, General Eastern agent
of the Grand Trunk Railway. Both these
gentlemen are well equipped in every way
for the performance of the difficult task

assigned them, and both did what they considered right and fair to all concerned.

Many readers will be disappointed at not finding their names in the list, and others at not finding theirs as far up as they had expected; but all such should remember the peculiar conditions that enter into a contest of this kind. No man or woman can possibly appreciate the difficulty under which the judges labor, without being themselves placed in such a position.

I trust that all who were successful in this competition may be even more so in the next, and that those who did not win prizes this time may get good ones the next time.

Only 40 prizes were offered in this competition, and, of course, only this number were awarded by the judges. I have, however, decided to send RECREATION one year to each of the persons named on the list and numbered 41 to 54 inclusive.

PSEUDO STEREOSCOPIC PICTURES.

BARON PAUL TCHERKASSOV.

Anyone who has looked at a photograph through a magnifying lens must have no-

stereoscopic work. I have taken it up recently and during this brief time it has afforded me much more enjoyment than I formerly got out of photographic work with a half plate stand camera and a quarter plate hand camera, with which I have taken many pictures in the last 12 years. One day in 1901, while going through some old prints, the idea came to me that it might be possible to get a stereoscopic effect with some of them. After a few trials, I learned how to dispose the 2 separate prints, and what sizes to give them, as well as a few minor points the knowledge of which facilitates the work. The results having proved satisfactory, a brief outline of my methods may interest other photographers.

Two conditions must be fulfilled in order to attain good results: The focal distance of the lens should be between 4 and 5 inches; and prominent objects in close proximity to the camera should be avoided. This may require some explanation. In genuine stereoscopic work, it is on the utmost advantage to get some prominent objects in as close proximity to the lens as the latter's construction permits, for such objects, appearing on the 2 separate prints

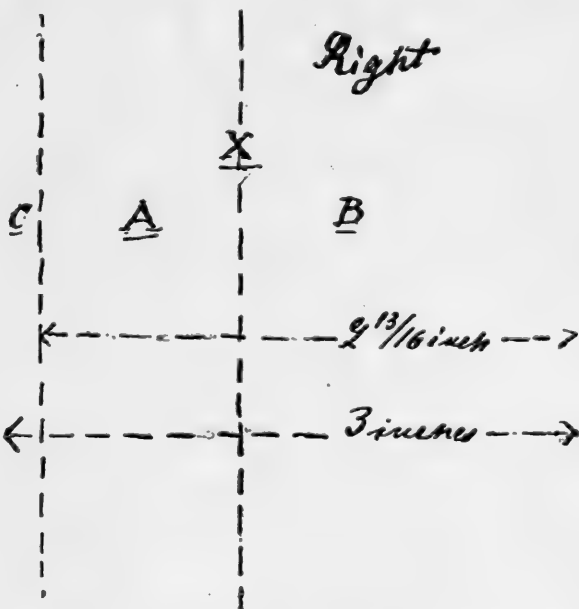

ticed how much more lifelike it looks; how all the objects stand out in strong relief; how much more natural the perspective appears. It must be obvious that if one picture, seen through one magnifying lens, gains so much, a binocular contemplation of 2 identical pictures through 2 lenses is bound to produce a still more striking effect. This is shown to the utmost perfection attainable with pictures in monochrome, in stereoscopic pictures, taken with a properly constructed stereoscopic camera. It seems strange, therefore, that, as nearly as I can judge by my personal experience, hardly 20 per cent of amateur photographers do

in different positions relative to objects situated farther from the lens, are of great value in bringing out the stereoscopic effect; but, in *pseudo* stereoscopic work, where they necessarily stand in the same relation to other objects, in both prints, they are not of such value in enhancing the effect of the stereoscopic image, while they reveal to the careful observer the imitation.

It is strange how differently people regard the same picture when they think it is genuinely stereoscopic and after they learn that it is what they call faked. I once showed my collection to some friends.

who admired them greatly and did not criticize those views among the lot which were imitations. Afterward I said that some of the pictures were made up from photos taken with an ordinary hand camera; and they went over the whole collection again, but could not find out which were which till I pointed them out. Then it was a case of: "Well, it is wonderful we did not notice it before! Now we see the difference clearly." After that, they seemed not to care for my made up stereoscopic pictures, though some of them are exceedingly beautiful.

Given a pair of perfectly matched prints, that is, identical in depth and in tone, the next question is what size to cut them, how to trim and how to mount them so as to obtain the desired stereoscopic effect. I take 3 inches wide by $3\frac{1}{4}$ high as about the standard. Selecting some point in the picture from which to take the necessary measurements for the width, trim one print so as to get that point 3-16 of an inch farther from the left edge than in the second print. In the second print, add this space of 3-16 inch to the right margin, measuring, of course, from the same fixed point. That is, designating the different parts of the print thus: A, the strip to the left of the arbitrarily chosen starting point X; B, the strip to the right of that point; and C, the 3-16 inch wide strip; the right hand image has the following formula: $C + A + B$; and the left hand image, $A + B + C$. See diagram.

Mount the 2 prints on the stereoscopic blank. To do this properly requires but average care and ability. The most important operation is to get the base lines of both prints perfectly true. Next comes the trimming of those edges which will come into juxtaposition in the center of the blank. A space a trifle over 1-16 inch wide may be left here, but I usually mount the edges close together.

There is, perhaps, no novelty in this style of making up stereoscopic prints from single ones. If this should happen to be the case, I can only say that I never have come across a description of it, or heard of it. All there was to learn about it I have worked out by myself, "rule of thumb" fashion. The deductions came afterward.

MAKING THE PRIZE WINNERS.

Regarding the winner of 3d prize, Bob White by Flashlight, reproduced on page 104 of this issue, I wrote Mr. Beegle as follows:

Will you kindly tell me all about the conditions under which the quail picture was made? Was the photo made from a live bird or from a mounted specimen?

It appears to me to be from a live bird, but if you have been reading RECREATION, you will know that as soon as the picture is published some critics may bob up and claim it is from a mounted specimen.

The second question is, if the bird was alive, was he in his wild state or in domestication, or in confinement. If at large, you have been exceedingly fortunate in getting so fine a picture of him.

The judges, in awarding the prizes, would immediately raise all these questions, and it will be well to have a full statement from you with the picture.

To this, Mr. Beegle replied.

My photo of a quail was made from a live wild bird, not domesticated, although it was a captive several days, and after the photo was made flew away, perhaps to become the prey of some gunner. To assert or imply that it was a snap shot of a quail in the grass, taken by going afield with a camera, would be more than ridiculous; but it is exactly what it represents, a live wild bird, free and unhampered, released and photographed in a tuft of grass, without any strings or other contrivances to keep it confined. It seems to me that any man who ever saw a quail can tell from the natural expression of the bird, the alertness, etc., that no taxidermist could duplicate it. Those who might think it a photo of a mounted specimen I should under no circumstances try to convince. They would not have the intelligence to know a live quail from a stuffed one, and they deserve no consideration whatever. To those who have done any of this work I stand ready to demonstrate that possibly even better pictures may be made than the one submitted.

This photo was taken with a Goerz lens, 1-10 second exposure, and printed on Velox paper.

S. L. Beegle, Orange, N. J.

The photo of the caribou stag on the barrens of Newfoundland was taken October 24, 1903, at 50 feet, as the animal was coming slowly toward me. The camera used was an Eastman Cartridge Kodak, No. 4.

Mrs. William B. Lee, Rochester, N. Y.

This photo is reproduced on page 101 of this issue. —EDITOR.

Ernie: No, she isn't going to marry Claude, after all.

Ida: But they say he can quote Emerson and Browning.

Yes, but the other young man can quote Sugar and Steel.—Chicago Daily News.

RECREATION is the best magazine published. J. M. Kyle, Cedarville, O.

PREMOS and POCOS

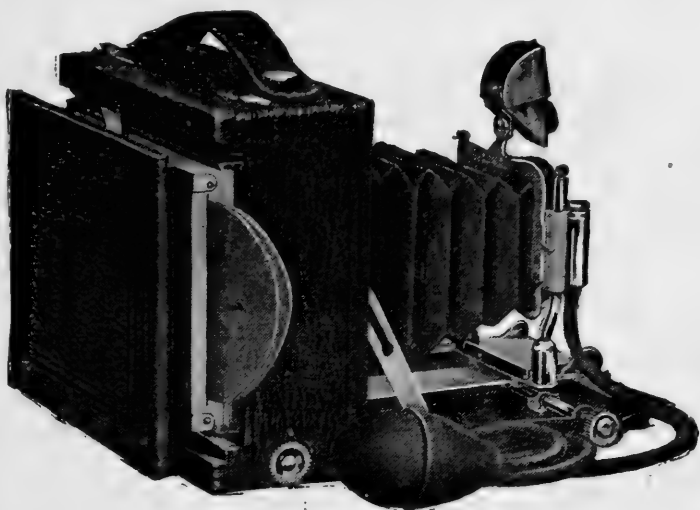

as
Film
Cameras

By means of Premo Film Pack Adapter any $3\frac{1}{4} \times 4\frac{1}{4}$ or 4×5 Premo or POCO becomes a daylight loading film camera, and you may

**Focus on the
Ground Glass**
Just as with Glass Plates

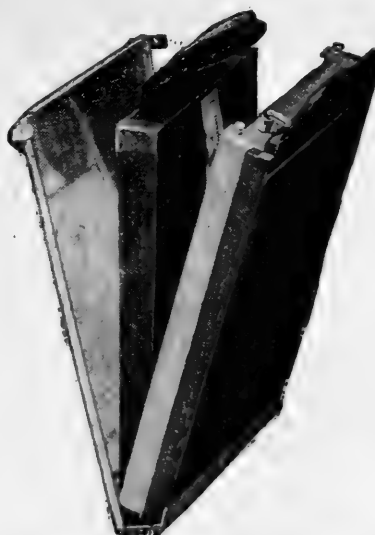

ADAPTER—size of ordinary plate holder

The Film Pack (12 exposures) loads into Adapter in simplest possible way. After exposure, a single motion presents next film.

$3\frac{1}{4} \times 4\frac{1}{4}$ Premo Film Pack Adapter	-	-	-	-	-	\$1.00
Premo Film Pack, 12 exposures, $3\frac{1}{4} \times 4\frac{1}{4}$	-	-	-	-	-	.70
4×5 Premo Film Pack Adapter	-	-	-	-	-	1.50
Premo Film Pack, 12 exposures, 4×5	-	-	-	-	-	.90

For use with Film Pack only

PREMO FOLDING FILM CAMERA

PREMO BOX FILM CAMERA

Rochester Optical Co., ROCHESTER
NEW YORK

Ask the dealer or write us for booklet

"Century" Cameras.



"Century" Quality

is the result of twenty years' practical experience in Camera building. Is it any wonder, then, that **Perfection** is realized in the

"Century"?

Not only are Centurys perfect Plate Cameras, but they are also adapted for Daylight Kodak Film and

The New Film Pack.

Our complete Catalogue tells all about them. Can be had from your dealer or by mail direct.

CENTURY CAMERA CO.
Rochester, N. Y.

A Press Button Hunting Knife

Is one of the best articles a hunter ever carried

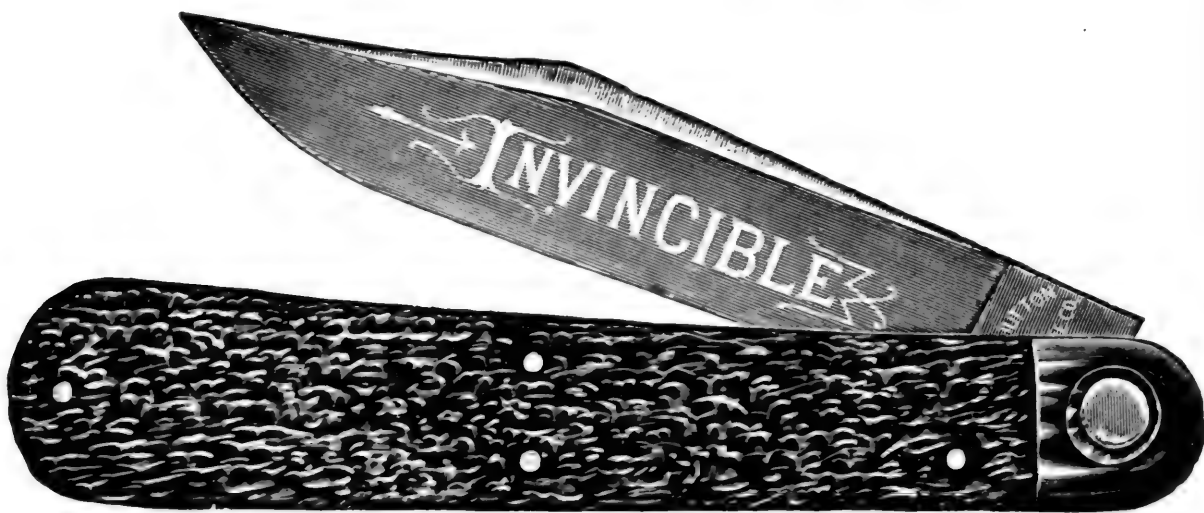

It has a 4 Inch Blade made of the Best Silver Steel

The knife cannot come open in your pocket. It cannot close on your hand when in use. It opens and closes only when

YOU PRESS THE BUTTON

If you once use one of these knives you will never use any other. You can get one as a premium for

3 YEARLY SUBSCRIPTIONS TO RECREATION

Sample Copies furnished on request.

COONING IN DELAWARE.

Jack and I drove to the branch to try our new coon dog, Trueman. While we were tying our horse my pup Moscow struck in the branch, the new dog gave tongue, and in less than 5 minutes both were barking to a tree not far off. When we got there all we could see was Trueman's tail sticking out of a hollow stub about 4 feet high. He had jumped up on the stub and gone into it head first. The hollow was too small for him to turn around in and too deep to back out of. We grabbed the dog by the tail and hind legs and pulled him out. He brought the coon with him and never let go until it was dead.

Farther up the branch Trueman struck another trail and ran it about half a mile. He finally lost the scent, either because of the thick brush and wet ground or, more probably, as I have since learned, through my bad handling. On the way back to where we had tied the horse the dog commenced to bark. We found he had another coon in a hollow log. It took about an hour of hard chopping, punching and prying to get the rascal out. He is now living in my coon cage, as contented as can be.

W. L. Barnes, Seaford, Del.

Mrs. Noorich—That picture's one of the old masters.

Norah (the new maid)—Well, it can't be of any value, ma'am, or sure he'd 'av' took it wid him whin he moved.—Harper's Magazine.

**LANTERN SLIDES COLORED
SKILLFULLY AND ARTISTICALLY
FOR
Lecturers, Teachers and others**

I refer by permission to the Editor of RECREATION

MRS. C. B. SMITH
The Ansonia, 74th St., & Broadway,
New York City.

The Davenport you kindly gave me is the cutest little rifle I ever saw. I thank you heartily.

W. Baumline, Albany, N. Y.

No Curl to Eastman's N.C. Film.

The one drawback to the use of film has always been its tendency to roll up. There's none of this with N. C. Film. There's not even a modified curl. It lies flat in development and afterward the negatives may be as readily handled as so many pieces of thin cardboard. No other film is like it. It is patented. Develops in daylight if you have a Kodak Developing Machine.

It has other advantages too—orthochromatism (*i. e.* a correct rendering of color values) speed—latitude.

Your Kodak dealer has it. No advance over the prices you have always paid for Eastman film.

**\$4,850.00 in Cash Prizes
for Kodak Pictures. Send for circular.**

EASTMAN KODAK CO.
ROCHESTER, N. Y.

OIL PORTRAITS ON APPROVAL.

If you will send me a photo of yourself or a friend and state color of hair, eyes and complexion I will paint and send you on approval a miniature oil or pastel portrait.

Canvas 6x8 or 8x10 inches, \$10.00
Canvas 10x12 or 12x14 inches, \$15.00

Z. EMMONS, 58 West 104th St., New York.

Reference: Mr. G. O. Shields.

For Golf & Tennis Players

"PRESTO! - CHANGE!"

ATTACHABLE EYEGLASS TEMPLES



Eye Glasses into Spectacles. Spectacles into Eye Glasses

BE PROTECTED!

DON'T BREAK OR LOSE YOUR GLASSES IN EXERCISE, WIND AND STORM

Can be attached by anyone

Send thickness of lens when ordering by mail

Price in Nickel 50c. a pair.

Gilt 75c. a pair.

Gold Filled \$1 a pair.

Solid Gold \$2.50 a pair.

Established 1842

GALL & LEMBKE, Dept. C, 1 W. 42d St.

21 Union Sq., New York Send for Circular



PATENTED
JULY 17th 1902



COVERED BY
Foreign Patents

No. 3 Weno Hawk=Eye

POPULAR SIZE

POPULAR PRICE

EASY TO OPERATE

EVER READY

Makes picture $3\frac{1}{4} \times 4\frac{1}{4}$. Sells for \$9.00. Fitted with Automatic Shutter, Iris Diaphragm, Universal Focus Lens. **It's EVER READY.** Uses Perforated Daylight Loading Film, also Eastman Cartridge Film.

No. 3 Weno Hawk=Eye, \$9.00

Full Description in Hawk-Eye Booklet.

BLAIR CAMERA CO.

Rochester, N. Y.

Do you want a Good, Reliable,
Substantial, Well Made

Single Barrel Shot Gun

If so, send me

10 YEARLY SUBSCRIPTIONS

and I will send you such a
Gun as a premium

It is made by the *DAVENPORT ARMS CO.*, and this means it is made of good material and that only good workmanship is put on it.

This is one of the many remarkable opportunities *RECREATION* is offering to men and boys to fit themselves out completely for shooting and fishing.

Sample Copies for Use in Canvassing
Furnished on Application.

Address

RECREATION

23 W. 24th St., New York City

IN ANSWERING ADS PLEASE
MENTION RECREATION.



Burnt Work—Something Great. To persons sending subscriptions to *RECREATION* through me, or sending them direct to the office to my credit, I will send the following prizes:

For 1 yearly subscription to *RECREATION* I will give a neat barrel match safe mounted on an oval back, both burned and decorated, equal in value to 75 cents.

For 2 yearly subscriptions to *RECREATION* I will give a 6 inch round picture frame burned and decorated with beautiful old fashioned poppies tinted with water colors. These would cost you \$1.25 at the least.

For 5 yearly subscriptions to *RECREATION* I will give either a round stool 14 inches high with round upholstered top or a square stool same height with square upholstered top. These would probably cost you \$7 or \$8 finished as I finish them with designs burned in the wood and leather.

RECREATION is fine. I like the way you give it to the game hogs. Give them some more; they need it.
C. S. Humphrey, W. New Brighton, N. Y.

The Mayor of a small provincial town in France had the following notice promulgated:

"After analysis at grocers' and wine merchants', eatables and drinkables that have been pronounced injurious to health will be confiscated and distributed among the various local benevolent institutions."—Exchange.

It's Not a Toss-Up



as to the quality of pictures made with a

KORONA Camera



GUNDLACH-MANHATTAN OPTICAL CO., 730 So. Clinton Ave., Rochester, N. Y.

“THE KORONA and the FILM PACK”

is the title of an artistic
little folder which tells how
the **KORONA** can be
c o n v e r t e d i n t o a

Focusing Film Camera

by the use of the

FILM PACK ADAPTER

Do you want it? Your name, please.

Mention RECREATION.

Going Fishing?

Well fixed for rods? If not,
send me 5 yearly subscriptions to
RECREATION
and get a Bristol Steel Rod—
any one listing at \$6.00 or less.

Everybody knows what a Bristol
Steel Rod is. It is equal in
strength, durability, suppleness,
and all the other good qualities to a
split bamboo rod costing \$20.

BEYOND A DOUBT GOERZ DOUBLE ANASTIGMATS

For all around Work are UNEQUALLED



We would **draw your attention** to the **illustrations** on pages 88 to 98 of this magazine. **All of the original Photographs** were made with

GOERZ DOUBLE ANASTIGMAT LENSES

We are now prepared to supply **Sector Shutters** of all sizes, and at the following **reduced prices**: \$17.00 for small and \$20.00 for the larger sizes.

Ask for our new illustrated catalogue

C. P. GOERZ OPTICAL WORKS

52 E. UNION SQUARE Room 27, NEW YORK CITY

Mention RECREATION.

A PROSPECTOR'S HOLIDAY.

GEO. F. WRIGHT.

Last winter, while encamped on Snake river about 100 miles above Lewiston, we saw bighorn sign. We were prospectors; but it was our off season and there was plenty of grub in the cabin. Moreover, as we could not get back across the Seven Devil mountains until spring we could well afford to put in a day or so after sheep. The pursuit of that variety of game is usually beset with difficulties that make it more work than sport; but it was different with us.

For 100 miles or more Snake river runs in a canyon which is relieved here and there by flats a few acres in extent at the mouth of some mountain stream. These flats yield fine gold, as does all the dirt along the river. Travel beside the stream is exceedingly dangerous; so we had crossed the mountains, a few weeks before, to reach our flat. Although shut out from civilization, we were happy. There was no snow on the flats and but little on the lower slopes of the mountains. The richness of the soil in that region makes amends for its scarcity. There the bunch grass loses its distinctive feature. It does not bunch, but forms a carpet that brings joy to the heart of a hungry cayuse. Nor is there lack of animal life. The morning after we got settled I found, across the stream and not a stone's throw from our shack, the remains of a bighorn buck, with cougar sign around it.

When ready for our hunt we started afoot, leading a pack horse, for the mountain summit. The trail was badly uptilted at the farther end, but after 3 hours' climbing we bumped into zero weather. Just inside it stood the Grand Patriarch of all the bighorn bucks on that range. Not long did he stand, and out of sight he went before we could get a shot. A thousand yards away he came into view again, going 23 feet at a jump and not rising in the air an inch.

My partner had recovered his breath by that time, and blazed away with a .45-70. The first shot struck 100 feet too low, and the second was worse. I was so completely out of breath that I knew I could not shoot standing. Running to an opening, I threw myself flat on what I too late found was a snow bank. When I had rescued myself I began pumping pug-nosed bullets into the vacuum the buck was making. I scored clean misses with my first 2 shots. The third was a scratch on the white patch the buck wore on his trousers. What was left of his heart after the fourth shot, we had for lunch. The horns were 14¾ inches around.

A few minutes later we reached the summit of the mountain. The top, sliced off by glacial action, is a plateau of about 200 acres, exposing a rich deposit of gold-bearing gravel. Miners who visit the place in the spring can, with the little

snow water they are able to save, rock out \$10 to \$20 a day for a few weeks.

In one of the cabins on the summit we ate a light lunch of 2 quarts of pink beans, the same quantity of coffee, dashed with canned cream, and, last and greatest, the heart of the buck.

Then we looked across Snake river at Oregon and range after range of golden, green, red and snow-capped mountains. It was worth living 32 years just to stand there and look. Almost under our feet, far below winter, we could see summer and our cabin in the valley; and everywhere about us, amid kinnikinnic brush and mountain mahogany, was mule deer sign.

We continued the hunt after exchanging rifles; my partner saying that having seen a full Lyman rigged Savage at work, he was disgusted with his smoke-maker. Coming presently to a little mound covered with mahogany, he took one side and I the other. In a few minutes I walked out of the brush and almost into 2 magnificent bucks facing each other and pawing the snow. In the same instant they saw me and were off down the mountain. When I had fired 3 times one was out of sight and the other lay, 300 yards away, with a hole in his head and one of his prongs shot off. He was a beauty, and so heavy I could not drag him. I called my partner, and we cut off the buck's head and hung it up after making a second count of the 10 points it sported.

The fact that impressed us most was that though we had eaten game meat of all kinds, from the Arctic circle to any old place, we had never enjoyed anything else as we did the flavor of that buck's liver. Large thick slices of it, well done with bacon on the side, sour dough bread and a ravenous appetite combined in the making of a gastronomic triumph. How so much tenderness got inside such a hunk of gristle as that deer was, I have not yet figured out. We could not stick a knife in gravy made from the rest of the beast.

Detroit, Mich.

The Peters Cartridge Co.,
Cincinnati, Ohio.

Dear Sirs: You are not the only manufacturer of shells, and friends of RECREATION can use other brands. You should bear in mind that there is only one RECREATION, that its friends are legion and that most of its subscribers, myself included, do not use shells not advertised in it.

F. H. Cogswell.

I am very much pleased with your magazine, as I think everyone who enjoys sport ought to be. I have read a good many books, but RECREATION beats them all.
Carl B. Edminster, White River Junction,
Vt.

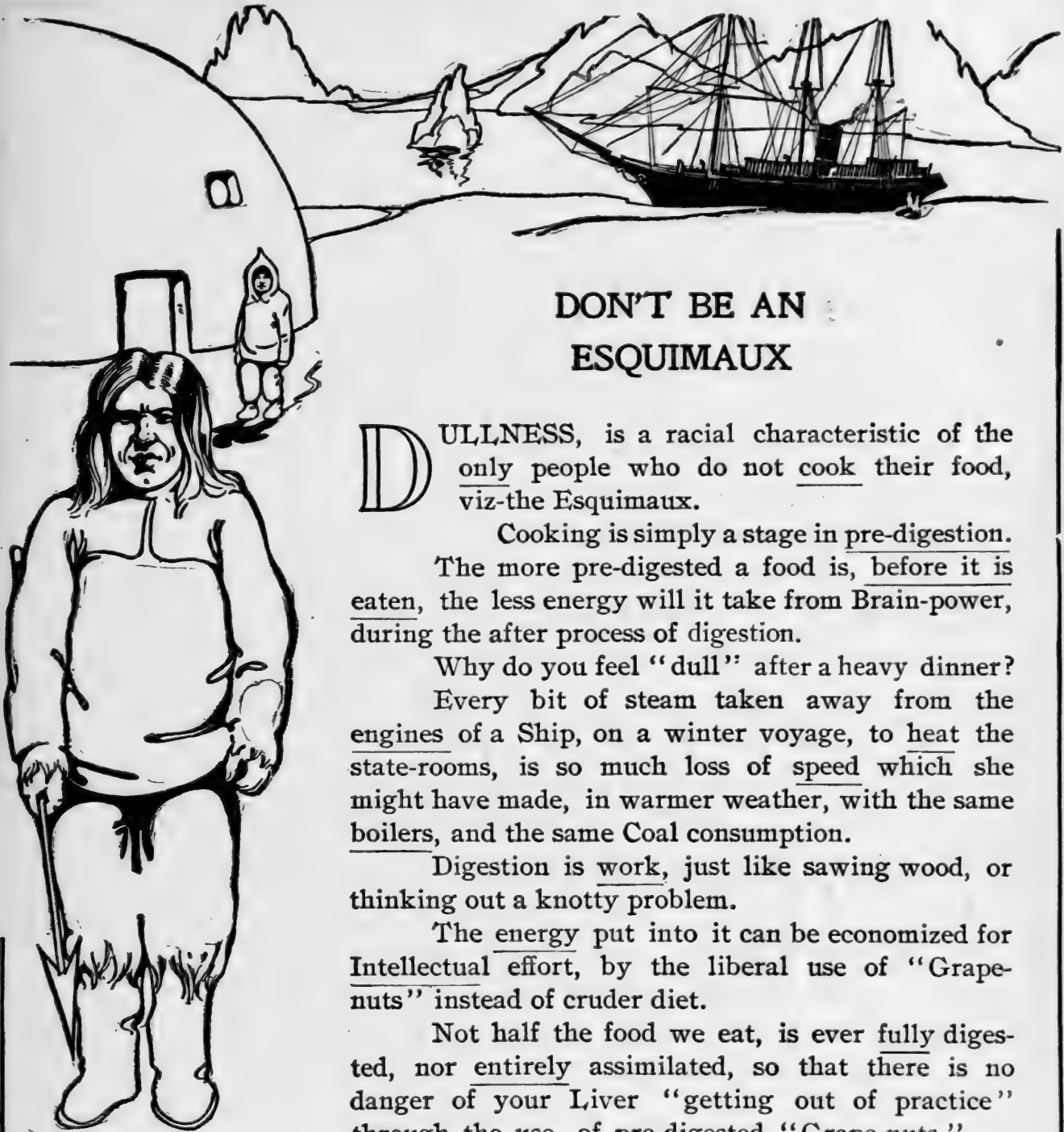

DON'T BE AN ESQUIMAUX

DULLNESS, is a racial characteristic of the only people who do not cook their food, viz-the Esquimaux.

Cooking is simply a stage in pre-digestion. The more pre-digested a food is, before it is eaten, the less energy will it take from Brain-power, during the after process of digestion.

Why do you feel "dull" after a heavy dinner?

Every bit of steam taken away from the engines of a Ship, on a winter voyage, to heat the state-rooms, is so much loss of speed which she might have made, in warmer weather, with the same boilers, and the same Coal consumption.

Digestion is work, just like sawing wood, or thinking out a knotty problem.

The energy put into it can be economized for Intellectual effort, by the liberal use of "Grape-nuts" instead of cruder diet.

Not half the food we eat, is ever fully digested, nor entirely assimilated, so that there is no danger of your Liver "getting out of practice" through the use, of pre-digested "Grape-nuts."

The Postman doesn't forget how to walk, merely because he rides home on a street car, when he is tired.

"Grape-nuts" is Wheat, with its Energy-producing Starch, and its Brain-building Phosphates, pre-digested beyond the Liver stage, ready for prompt assimilation and superior Brain work.

A Government analysis proves it to be eighteen times readier for assimilation than Oatmeal, and thrice as dextrinated as the average Wheat food.

This analysis will be sent free on request.

Grape-Nuts



Bicycle Cards are Good Cards.

Their splendid wearing, dealing and playing qualities, are found in no other popular-priced card. Sold by dealers from Greenland to Tasmania.

The U. S. Playing Card Co.
Cincinnati, U. S. A.

HOYLE for 10c. In stamps—128 pages.
Address Dept. 23

For Duplicate Whist, best of card games, use Falne's Trays
Lessons free with each set of trays. Write for particulars.



Club Cocktails

Famous the world over for purity. They never vary. The secret of their perfect blend is that they are kept six months before being drawn off and bottled. Be sure you have them in your camp, on the yacht, and on your outing trips wherever you go. They are ready and require no mixing. Simply pour over cracked ice.

For Sale by all Fancy Grocers and Dealers

G. F. HEUBLEIN & BRO.
29 BROADWAY, N. Y. HARTFORD, CONN.

DO YOU WISH TO IMPROVE YOUR SHOOTING? IF IT IS AS GOOD AS IT CAN BE, DO YOU WISH TO KEEP IT SO? IN EITHER CASE, THE J. C. HAND TRAP WILL BRING WITHIN YOUR REACH THE FULL ADVANTAGE OF A SHOOTING RANGE. THESE TRAPS WILL SUCCESSFULLY THROW ANY OF THE CLAY TARGETS NOW IN USE, GIVING A LIFE LIKE REPRESENTATION OF A BIRD IN FLIGHT. I WILL SEND YOU A J. C. HAND TRAP FOR 5 YEARLY SUBSCRIPTIONS TO RECREATION. SEND IN YOUR CLUB NOW, AND IMPROVE ON YOUR SHOOTING.

Chicago, Ill.

The Peters Cartridge Co.,
Cincinnati, Ohio.

Dear Sirs: As a sportsman and a subscriber to RECREATION I wish to express the surprise I feel at your course in withdrawing your ad from that magazine because a correspondent, writing on sporting matters, expressed an unfavorable opinion of your cartridges.

The value of the correspondence in a sportsmen's magazine consists in the confidence inspired by its honesty and candor, its fairness and the independence of its contributors. If no one was allowed to express his views of anything advertised in the paper, unless those views were favorable, how long would the paper retain the confidence of its readers?

I am largely influenced in my opinion of sporting goods that I have not tried by the opinions expressed in RECREATION of fellow sportsmen who have. But would I be so influenced if convinced that their letters were only puffing adjuncts to the advertising department of the magazine?

No, gentlemen, you are wrong. Your course is not one that fair minded sportsmen can approve. You show yourselves unduly sensitive. Ammunition that requires such methods to defend it must be far from perfect. It is only fair, however, to suppose that you acted in a fit of temper. If so, there is yet time to set yourself right in the estimation of sportsmen.

Channing M. Coleman.

BIG MONEY In Mail-Order Business

People are buying more by mail than ever before: one mail order house does a business of a million dollars monthly; another receives 2,000 letters daily, nearly all containing money; mail order trading is unquestionably the business method of the future. The field is large, the possibilities unlimited. Let us send you our plan for starting beginners; it covers every point. Enclose stamp.

CENTRAL SUPPLY CO., Kansas City, Mo.

PLAYS Dialogues, Charades, Recitations and other entertainment books.

Send for free catalog of over 2000 plays.
Dramatic Publishing Company

358 Dearborn St. Chicago, or 40 W. 28th St., New York

A RARE OFFER

A TREAT TO YOU—"A SURPRISE"

Three Splendid Books

500 Pages. Over 1,000 Illustrations

Covering every subject of

**FISHING
ANGLING
HUNTING
CAMPING, Etc.**



Send 10c. in coin or stamps for either book or 30c. for the three books.

The Best and Most Instructive Books ever published (they will surprise you).

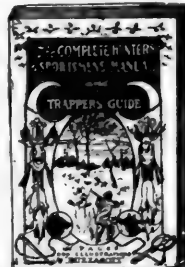

A Remarkably Good Offer DON'T MISS IT

Write at once

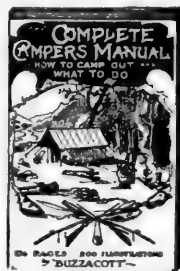

THE BIGGEST VALUE

ever offered the Sporting Public, so say thousands of sportsmen.

The three Books bound in one volume of 500 pages, now ready. "A Complete Sportsman's Library." Circular free

WRITE AT ONCE. Address

"BUZZACOTT," Racine Jct., Wis.

PIANO Do You Want a Genuine Bargain

Hundreds of Upright Pianos returned from renting to be disposed of at once. They include Steinways, Knabes, Fischers, Sterlings and other well known makes. Many cannot be distinguished from new yet all are offered at a great discount. Uprights as low as \$100. Also beautiful New Uprights at \$125, \$135, \$150 and \$165. A fine instrument at \$290, fully equal to many \$400 pianos. Monthly payments accepted. Freight only about \$5. Write for list and particulars. You make a great saving. Pianos warranted as represented. Illustrated Piano Book Free.

FROM LYON & HEALY

39 Adams St., CHICAGO.

World's largest music house; sells Everything known in Music

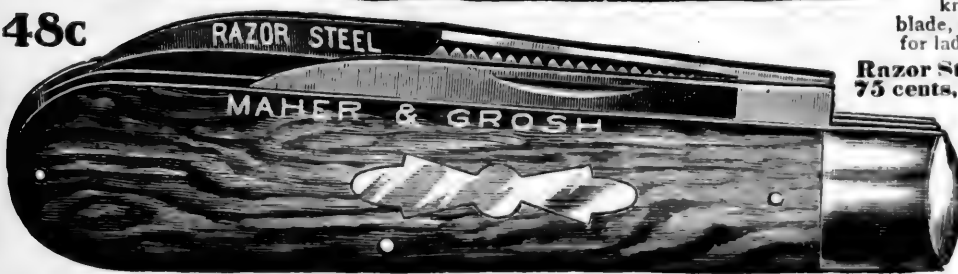

48c

Our Guarantee: The Record of 25 Years

Time proves all things, and our record with a million customers tells our story. We deal direct with consumers and warrant every blade hand-forged razor steel. This is "Chauncey Depew's Pet," has three blades (one is a file). Handle is choicest selected pearl; German silver back and ends. Price, in chamois case, \$1.50, postpaid. Same knife, 2 blade, \$1; plainer finish, 3 blade, same quality \$1; smaller, 2 blade, for lady, \$1; plainer finish, 75 cents.

Razor Steel Jack Knife, 2 blade, price, 75 cents, but 48 cents for a while; 5 for \$2. This knife and 60c. Shears for \$1.00. Hollow Ground Razor and Strop to suit, \$1.33. Illustrated 80-page list free, and "How to Use a Razor."

MAHER & GROSH CO.,
74 A Street, Toledo, Ohio

SOME RARE OPPORTUNITIES

These goods are all new, and will be shipped direct from factory. Prices named are those at which manufacturers and dealers usually sell. Here is a good chance to get

A Book, a Gun, a Camera
A Sleeping Bag, a Fishing Rod
A Reel, a Tent, } FREE OF COST

Subscriptions need not all be sent at once. They may be sent in installments as taken and credit will be given on account. When the required number is obtained the premium earned will be shipped.

TO ANY PERSON SENDING ME

TWO new yearly subscriptions to RECREATION at \$1 each, I will send a copy of *Hunting in the Great West*, cloth; or an Ingersoll Watch or Cyclometer, listed at \$1; or a Recreation Waterproof Match Box, made by W. L. Marble and listed at \$1; or a Shakespeare Revolution Bait listed at 75 cents; or a Laughlin Fountain Pen; or a dozen Trout Flies, assorted, listed at \$1; or a pair of Attachable Eyeglass Temples, gold-plated, made by Gall & Lembke; or one Rifle Wick Plug, made by Hemm & Woodward, Sidney, Ohio, 30 caliber to 50 caliber, or Shotgun Wick Plug, 20 gauge up to 10 gauge, or a pair of chrome tanned horsehide hunting and driving gloves, listed at \$1.50, made by J. P. Luther Glove Co.

THREE new subscriptions at \$1 each, a safety pocket ax, made by W. L. Marble and listed at \$2.50; or a dozen Bass Flies, assorted, listed at \$2; or a pair of Shotgun Wick Plugs made by Hemm & Woodward, Sidney, Ohio, 20 gauge to 10 gauge; or a Polished Buffalo Horn Gun Rack, made by E. W. Stiles; or a pair of gauntlets, for hunting and driving, ladies' size, listed at \$2.50, made by J. P. Luther Glove Co., or a Press Button Jack Knife, made by The Novelty Knife Co., and listed at \$1.

FOUR new subscriptions at \$1 each, an Ideal Hunting Knife, made by W. L. Marble and listed at \$2.50; or a 32 caliber, automatic double action revolver, made by Harrington & Richardson Arms Co.

FIVE new subscriptions at \$1 each, a copy of *Cruisings in the Cascades*, cloth; or a set of Nehring's Convertible Ampliscopes, listed at \$5.00; or an Ideal Hunting Knife made by W. L. Marble, and listed at \$3; or a pair of lock lever skates, made by Barney & Berry, listed at \$4.50; or a J C Hand trap made by the Mitchell Mfg. Co., listed at \$4.; or a Bristol Steel Fishing Rod, listed at \$6, or less; or a Yawman & Erbe Automatic Reel, listed at \$6 to \$9.

SIX new subscriptions at \$1 each, a Hawkeye Refrigerating Basket made by the Burlington Basket Co., or one dozen Eureka golf balls listed at \$4; or a Pocket Poco B 3¼x4¼, made by the Rochester Optical & Camera Co., listed at \$9.

SEVEN new subscriptions at \$1 each, a copy of *The Big Game of North America*, or of *The American Book of the Dog*, cloth, or one set Lakewood golf clubs, 5 in number, listing at \$5; or a series 11 F Korona Camera, made by the Gundlach Optical Co., listed at \$10.

EIGHT new subscriptions at \$1 each. A series 1, 4x5, Korona Camera, made by the Gundlach Optical Co., listed at \$12. or an Acme single shot gun, made by the Davenport Arms Co., and listed at \$8.

TEN new subscriptions at \$1 each, a Cut-Glass Salad Bowl, made by Higgins & Seiter, and listed at \$4.50; or a Waterproof Wall Tent 7 x 7, made by Abercrombie & Fitch, and listed at \$8; or a Rough Rider rifle telescope, made by The Malcolm Rifle Sight Mfg. Co., and listed at \$12; or a Pneumatic Camp Mattress, listed at \$18.

TWELVE new subscriptions at \$1 each, a Davenport Ejector Gun, listed at \$10., or a Cycle Poco No. 3, 4x5, made by the Rochester & Optical Camera Co., listed at \$15; or an 8 ft. folding canvas boat, made by the Life Saving Canvas Boat Co., listed at \$29.

FIFTEEN new subscriptions, \$1 each, a Shakespeare Reel, Silver Plated, listed at \$15; or a set of rabbit plates made by Higgins & Seiter, and listed at \$8, or a Field Glass made by Gall & Lembke; or a Kenwood Sleeping Bag, complete, with canvas cover, listed at \$16; or a Bulls-Eye rifle telescope, made by The Malcolm Rifle Sight Mfg. Co., and listed at \$16; or a 10 ft. special canvas boat, made by the Life Saving Canvas Boat Co., and listed at \$35; or a pair of horsehide hunting boots, listed at \$10.

TWENTY new subscriptions at \$1 each, a 14-karat small size Gold Hunting-case Watch, with Waltham Movement, listed at \$20; or an Elita single shot gun, made by the Davenport Arms Co., and listed at \$18., or an Acme Folding Canvas Boat, No. 1, Grade, A listed at \$27; or a Mullins Duck Boat, listed at \$20.

TWENTY-FIVE new subscriptions at \$1 each, A 4 x 5 Planatic lens, made by the Rochester Lens Co., and listed at \$45.

THIRTY new subscriptions at \$1 each, a Waterproof Tent, 14½ x 17, made by Abercrombie & Fitch, and listed at \$25.

FORTY new subscriptions at \$1 each, a Savage .303 Repeating Rifle; or a No. 10 Gun Cabinet, made by the West End Furniture Co., and listed at \$32.

FIFTY new subscriptions at \$1 each, a No. 20 Gun Cabinet, made by the West End Furniture Co., and listed at \$38.

TWO HUNDRED new subscriptions at \$1 each, a strictly first class upright piano, listed at \$750.

Address, **Recreation** 23 West 24th St.
New York



How To Grow Tall

WOULDN'T YOU LIKE TO ADD FROM TWO TO FIVE INCHES TO YOUR HEIGHT?

To be a "good height to dance with," to be "tall enough to see in a crowd?" To improve the symmetry of your figure and to add to your general appearance? It is entirely possible for you to increase your height and accomplish these other advantages in your own home without taking any internal treatment, without drugs, without operation, without pain or injury to yourself, without putting yourself to any inconvenience.

FREE TO ANY SHORT PERSON.

In order that anyone can learn how to get increased in height, we have prepared an interesting book for free distribution, explaining why some people are short and others tall, and telling how short people can add from two to five inches to their height, and get all the advantages that good height carries with it. All you have to do is to write for this book, stating your height, your weight, your age, your sex, and we will send you full particulars about the science of getting increased height and good figure. Address at once

THE CARTILAGE CO., DEPT. 104D, ROCHESTER, N. Y.

TO COQUINA, THE ROASTER.

V. S. FITZPATRICK.

We were camping in the mountains by a sparkling little brook,
When, one day, we got to arguing about our favorite cook.

I said mine was Coquina, and I sang his praises loud;

For when it comes to cooking he can do himself right proud

At frying, boiling, stewing and at making up a toast;

But to do him right and justice,

You should let him make pork roast!

First he heats the pan and oils it well,
with League of Sportsmen grease,

Then he grabs the filthy game hog and prepares him for the feast.

How that hog does squeal and holler as Coquina plies the knife!

For to make him fit for roasting he must skin the brute alive.

Then he jams him in the bake pan, RECREATION sauce spreads thick,

Puts him in an oven piping hot and bastes him with a stick;

Bring him out all nicely roasted; then we drink the cook a toast,

For the dish he's made so savory, is a sure 'nuff game hog roast!

IN ANSWERING ADS PLEASE MENTION RECREATION.

Good Beer Is a Food

Pabst Blue Ribbon is a good beer. By "good beer" we mean a scientific infusion of perfect malt and choice hops. To make a perfect food product the materials must be perfect, the plant must be clean, and the process must give no chance for impurity or infection.

Pabst Blue Ribbon

is made from selected barley under our own supervision; the hops are the best that can be bought, and the water is from Lake Michigan, the best water in the world for brewing beer. Pabst uses artesian water from his own wells for cooling beer, not for brewing it. Artesian water is "hard" water and not suitable for brewing good beer.

In the polished copper brewing vats, the water and malt are boiled for hours, cooled in pipes under flowing artesian water, and never exposed to air that is not filtered and purified. Perfect malt, choice hops and a clean plant make Pabst Blue Ribbon

The Beer of Quality

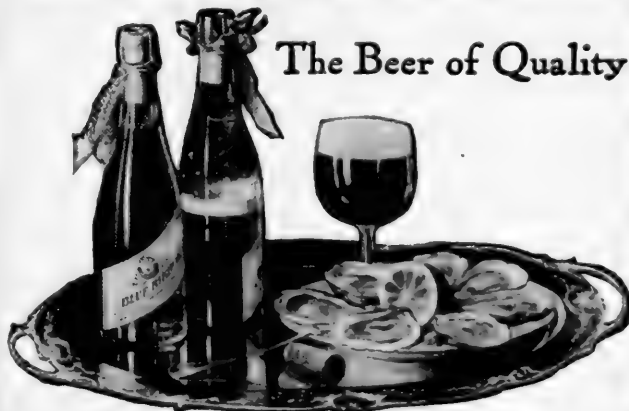

FREE

Until Cured



TRADE MARK

To men who suffer any personal weakness of whatever nature, the effects of indiscretions, overwork, exposure or excesses, varicocele, or from rheumatism, lame back, lumbago, kidney, liver or stomach complaints, I, beginning with this month, have this proposition to make: I will give you the use of my world-famed Dr. Sanden Electric Belt free until you are cured, and will not ask one cent in advance or on deposit. The price of my belts is from \$4 up, and when cured you pay the price of same, and no more, and not until then. The advice and guidance I will give you until your health is regained, is from nearly 40 years' successful experience, and will cost you nothing.

My reason for making this offer is simply to convince skeptics of my faith in my treatment. I have a remedy that I know will do what I claim for it, and from my knowledge of sportsmen feel safe in leaving it to their honor to do right by me if I do right by them.

I have two best little books ever written upon electricity and its medical uses, and even if you don't need or wish to try my treatment, they will interest and instruct you.

Write today for my treatment and books, free, by mail, sealed.

DR. G. B. SANDEN
1155 Broadway, New York

KEEP YOUR HANDS WARM

Send me 2 yearly subscriptions to **Recreation** and I will send you a pair of **Leather Hunting Gloves** made to your measure, by the **Luther Glove Co., Berlin, Wis.**

Sample copies for use in canvassing furnished on request

Taxidermy Free to Subscribers of Recreation.

To any person sending me \$1 for 1 year's subscription to RECREATION I will mount free of charge any bird up to and including the size of a robin, blue jay, etc. For 2 subscriptions I will mount birds the size of screech owl, quail, etc. For 3 subscriptions I will mount birds the size of ruffed grouse. For 4 subscriptions, red tail hawk, wood duck, etc. For 5 subscriptions, brant, fish hawk, etc. For 6 subscriptions, great horned owl, etc. For 7 subscriptions, great blue heron, etc. For 10 subscriptions, swan, pelican, eagle, wild turkey, etc. For 15 subscriptions I will mount a deer head. Or any person sending me work to the amount of \$10 or more I will give RECREATION for one year. Prices given on application and all work guaranteed. The subscriber must pay express both ways. Here is a chance for sportsmen to decorate their dens with trophies free of cost.

A. W. Perrior, 316 E. Kennedy St., Syracuse, N. Y.

I like RECREATION better than any similar publication I have seen and wish you success with it.

F. Sales, Bedford City, Va.



H. J. TILLOTSON, M. D.
The Master Specialist of Chicago, who Cures Varicocele,
Hydrocele, and treats patients personally.
Established 1880.
 (Copyrighted)

manent. My consultation will cost you nothing, and my charges for a perfect cure will be reasonable and not more than you will be willing to pay for the benefits conferred.

Certainty of Cure is what you want. I give a legal guaranty to cure or refund your money. What I have done for others I can do for you. I can cure you at home

Correspondence Confidential. One personal visit at my office is preferred, but if it is impossible for you to call, write me your condition fully, and you will receive in plain envelope a scientific and honest opinion of your case, Free of charge. **My home treatment is successful.** My books and lectures mailed free upon application.

H. J. TILLOTSON, M. D., 140 Tillotson Bldg, 84 Dearborn St., CHICAGO

Varicocele Hydrocele

**Cured to Stay Cured in 5 Days.
No Cutting or Pain. Guaranteed
Cure or Money Refunded.**

VARICOCELE. Under my treatment this insidious disease rapidly disappears. Pain ceases almost instantly. The stagnant blood is driven from the dilated veins and all soreness and swelling subsides. Every indication of Varicocele vanishes and in its stead comes the pleasure of perfect health. Many ailments are reflex, originating from other diseases. For instance, innumerable blood and nervous diseases result from poisonous taints in the system. Varicocele and Hydrocele, if neglected will undermine physical strength, depress the mental faculties, derange the nervous system, and ultimately produce complicated results. In treating diseases of men I always cure the effect as well as the cause. I desire that every person afflicted with these or allied diseases write me so I can explain my method of cure, which is safe and per-

A Fountain Pen

has become a necessity with every business man. You can get a

Laughlin Fountain Pen

Made by the Laughlin Manufacturing Co.
 Detroit, Michigan

For 2 Yearly Subscriptions to RECREATION

And you can get these 2 subscriptions in 20 minutes, any day.

The Laughlin is one of the best pens in the market, and thousands of them are in daily use.

There is no reason why you should be without one.

**Sample Copies of Recreation for Use in Canvassing
 Furnished on Application**

I always enjoy RECREATION and could not be without it.

J. C. Howenstein, Ft. Wayne, Ind.

Mother: Here, Bobby, you have forgotten to pack up your tooth brush.

Bobby: But I thought I was going on a vacation.—Exchange.

RECREATION is the best and only periodical for hunters who prefer sport to butchery.

Leo. I. Mulvery, Loyal, Wis.

"I Grow Hair"



This Magic Compound Grows Hair in a Single Night

**IN ONE
NIGHT**

I send a trial package of my new and wonderful remedy free, by mail, to convince people, it actually grows hair, stops hair falling out, removes dandruff and quickly restores luxuriant growth to shining scalps, eyebrows and eyelashes and restores the hair to its natural color. Send your name and address to the Altenheim Medical Dispensary, 866 Foso Bldg., Cincinnati, O., for a free trial package, enclosing a 2-cent stamp to cover postage. Write today.

ARNICA
Tooth Soap
the International Dentifrice

Beautifies the teeth, hardens the gums, sweetens the breath. Preserves as well as beautifies the teeth. Comes in neat, handy metal boxes. No powder to scatter, no liquid to spill or to stain garments.

25 Cents
At all Druggists.
C. H. STRONG & CO., Proprietors,
Chicago, U. S. A.



Free:—I will give anybody sending me 1 subscription or renewal, any one of the articles named below:

Ideal Shell Closer, 10-12-16 gauge, sells for 50c.

Ideal Shell Loader, 10-12-16 gauge, sells for 50c.

Perfection Gun Oiler, can not spill when not in use, worth 50c.

Web Shot Shell Belt, 10-12-16 gauge, sells for 75c.

Henry B. Floyd, 723 Eighth St., N. W. Washington, D. C.

IN ANSWERING ADS PLEASE MENTION RECREATION.

Are You an Amateur Photographer?



If so, would you like a Camera that will photograph

- A whole range of mountains
- A whole sweep of river
- A whole army
- A whole fleet of ships
- A whole city

Or any other vast stretch of scenery or moving objects? **THE SWING LENS DOES IT.**

The AL VISTA
Is the thing

One of the greatest inventions of the age.

I will give you a No. 5-B as a premium for 12 subscriptions. For particulars address

Recreation, 23 West 24th St. New York City

Sent on Approval
TO RESPONSIBLE PEOPLE
Laughlin
Fountain Pen

Guaranteed Finest
Grade 14k.
SOLID GOLD PEN.

To test the merits of

RECREATION

as an advertising medium we make this grand special offer, your choice of

These Two Popular Styles For Only **\$1.00** **Postpaid to any Address**

(By Registered mail 8 cents extra)

Holder is made of finest quality hard rubber, in four simple parts, fitted with very highest grade, large size 14k, gold pen, any flexibility desired—in feeding device perfect.

Either Style—**RICHLY GOLD MOUNTED** for presentation purposes, \$1.00 extra.

Grand Special Offer

You may try the pen a week; if you do not find it as represented, fully as fine a value as you can secure for three times the price in any other makes, if not satisfactory in every respect, return it and we will promptly refund your money.

Illustration on left is full size of Ladies' style; on right, Gentlemen's style. **Lay this RECREATION Down and Write NOW.**

Safety Pocket Pen Holder sent free of charge with each Pen.



ADDRESS :

Laughlin Mfg. Co.
424 Griswold St., DETROIT, MICH.

THE Keeley Cure

**Alcohol,
Opium,
Tobacco
Using ***

Produce each a disease having definite pathology. The disease yields easily to the Treatment as administered at the following Keeley Institutes:

ALWAYS ADDRESS THE INSTITUTE NEAREST TO YOU.

Birmingham, Ala.	Crab Orchard, Ky.	Fargo, N. D.	Columbia, S. C.
Hot Springs, Ark.	New Orleans, La.,	North Conway, N. H.	Dallas, Tex.,
Los Angeles, Cal.	1628-38 Felicity St.	White Plains, N. Y.	Bellevue Place.
San Francisco, Cal.,	Portland, Me.	Columbus, O.	Richmond, Va.
1170 Market St.	Lexington, Mass.,	Cor. 3rd and	Seattle, Wash.
West Haven, Conn.	Grand Rapids, Mich.	Dennison Aves.	Huntington, W. Va.
Washington, D. C.,	St. Louis, Mo	Portland, Ore.	Waukesha, Wis.
211 N. Capitol St.	2803 Locust St.	Harrisburg, Pa.	Toronto, Ont.
Augusta, Ga.	Boulder Hot Springs,	Philadelphia, Pa.,	Winnipeg, Man.
Dwight, Ill.	Boulder, Mont.	812 N. Broad St.	London, Eng.
Charlestown, Ind.	Omaha, Neb.	Pittsburgh, Pa.,	Cape Town, S. A.
Marion, Ind.	724 S. 19th St	4246 Fifth Ave.	
Des Moines, Ia.	Buffalo, N. Y.	Providence, R. I.	

Rev. T. DeWitt Talmage's famous lecture, "Evils of Intemperance," mailed on application. **LESLIE E. KEELEY, M.D., LL.D**

P. D. ARMOUR,

Head of the great Armour Packing Company, Chicago, Ill.,
(in a personal letter to Dr. Keeley) said:

I have sent about two hundred of my employees, from butchers to foremen, and all have been permanently cured. I do not think there is any one thing, or any one man, who ever did the good to humanity that you are doing with your cure.

Details of treatment and proofs of its success sent free on application.



In RECREATION for November I read that the Winchester Repeating Arms Company is about to manufacture an automatic shot gun. The destruction of game due to the repeating arms of the above and other makes is an undisputed fact, and the protest of every true sportsman should be raised against the manufacture of a weapon which will aid market or pot hunters, better styled by RECREATION game hogs, for such they are in their ruthless destruction. I, for one, protest, and I urge every true lover of the gun and rifle to use his influence to discourage the use and sale of automatic guns, save that they be used in the destruction of men who disregard our game laws and kill for the mighty dollar everything that wears fur or feathers.

I use a 12-gauge hammerless gun, and this is fast enough for me. I also use a Winchester, 30-40-92 model rifle, but have rarely had to use it as a repeater. I have hunted through Maine, New Hampshire and New York, and I think my experience should count for something. If minute automatic guns are placed on the market the men using them should be considered as miscreants, and not only they, but people who sell these guns should be prosecuted.

I have been a reader of RECREATION for years, and I commend your article to the sportsmen of the whole country for their support.

Theodore H. Seavey, Aldan, Pa.

WANT A REEL?

You can get one for nothing.
Or at least for a few hours' work.

Send me

15 Yearly Subscriptions
to
RECREATION

and I will send you

A TALBOT REEL

Listed at \$20

Made by W. H. Talbot, Nevada, Mo

This is one of the finest pieces of fishing tackle ever made. It is built like a gold watch. Equal to any Kentucky reel you ever saw.

**In Tournaments, Always a Victor
Among the Angler's Treasures, Always the Chief**

I have but a few of these reels in stock and this offer will be withdrawn as soon as the present supply is exhausted.

Sample copies of RECREATION for use in canvassing furnished on application.

D. M. TUTTLE CO.

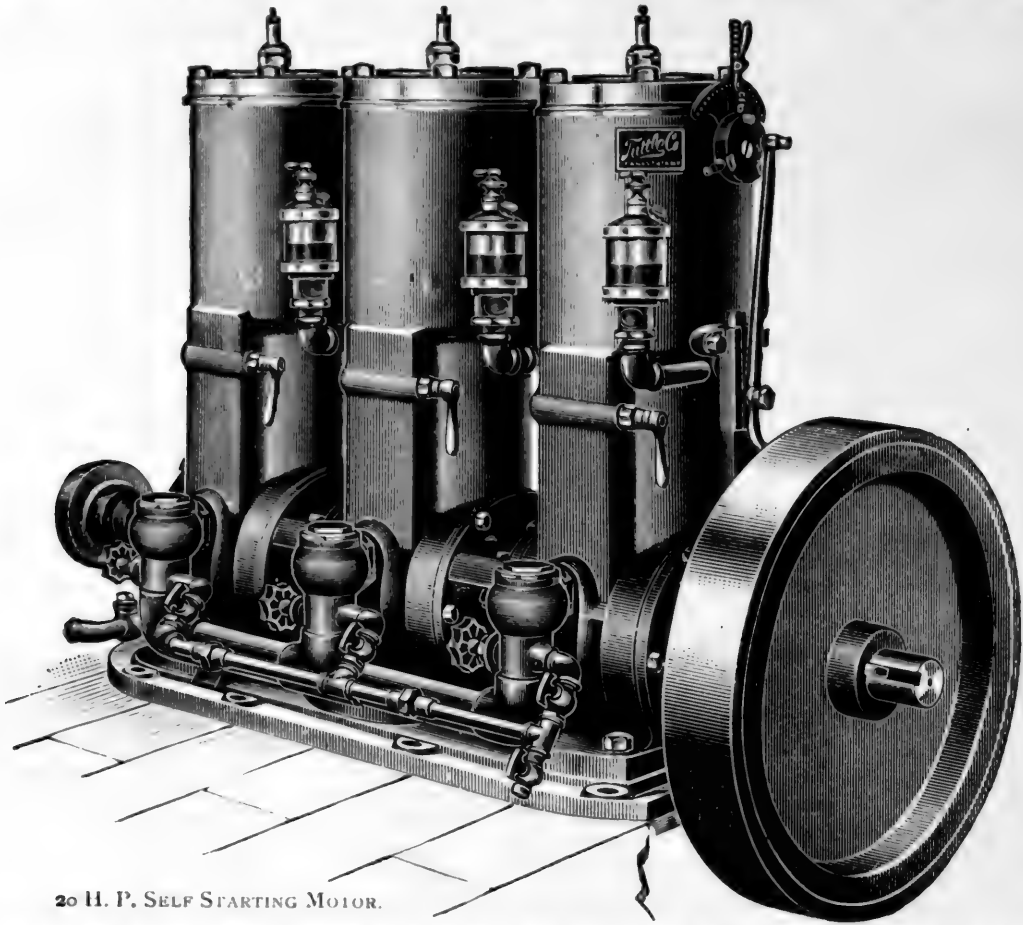

20 H. P. SELF STARTING MOTOR.

GASOLENE MOTORS AND LAUNCHES

THE above is a cut of our 3 cylinder self starting and reversible jump spark motor. With the cylinders once charged with the explosive mixture, the motor may be left for hours, after which it can be started, in either direction, by simply moving the lever attached to the commutator at top of front cylinder in the direction desired. The motor always comes to rest with one piston at the bottom of its stroke, with the other two on opposite side of crank shaft, with fresh charge partly compressed. The firing of either of these charges will start the motor, the direction being under control of the operator. The moving of the lever in either direction brings the segment in face of commutator in contact with brush in eccentric arm so as to ignite either charge, independently of moving the balance wheel. This lever also controls the time of ignition, which can be increased or retarded at the operator's will, allowing the motor to be slowed down to its minimum speed without use of throttles.

The two cylinder motors with this attachment are also self starting and a crank is not necessary as both can be started when cold by simply priming with gasolene and rocking the balance wheel to mix up charge and then making connection by means of the lever.

Motors from $1\frac{1}{2}$ H. P. to 20 H. P., one, two, three and four cylinders.

LAUNCHES



From 15 to 50 ft., Open, Half and Full Cabin. Any model. *Send for Illustrated Catalogue.*

D. M. TUTTLE CO., 10 Main St., CANASTOTA, N. Y.

The Western Recreation Launch

ABSOLUTE LAUNCH SATISFACTION

Is contained in the "Western Recreation." It possesses those essential points, Grace, Beauty of Outline, Symmetry, Simplicity and Safety. Speed is there too if you want it. Most reasonable in first cost, most economical to maintain.

THE BEST FINISHED, HANDSOMEST, MOST RELIABLE.

We build them with either Torpedo or Semi-Elliptic Hulls, and in completeness, it is the ideal and dependable craft for both pleasure and security.

The Western Marine Engine Will please those who build their own hulls. Beautiful Art Catalog describing our Launches and Marine Engines sent upon receipt of 10c. Catalog L.

WESTERN LAUNCH AND ENGINE WORKS, MISHAWAKA, IND.

RECREATION is the neatest and best thing published. It is genuine recreation to read it.
A. A. Ong, Moulton, Ia.

I would not be without RECREATION. Stay with the game hog, Coquina; you're all right.

T. J. Gardiner, Las Animas, Colo.

"Papa," said Tommy Treadway.
"Now, Tommy," replied Mr. Treadway, "I shall only answer one more question to-day, so be careful what you ask."

"Yes, papa."

"Well, go on."

"Why don't they bury the Dead sea?"—
Answers.

THE MATTHEWS TORPEDO LAUNCH

Any Power Installed
Cabin Work a Specialty
Quality Unexcelled

Address:

THE MATTHEWS BOAT CO.
BASCOM, OHIO, U. S. A.



The "Perfect" Fishing & Hunting Motor Boat.

Length, 17ft. Beam, 4ft. Weight 350 lbs. Speed 6 to 7 miles. Price \$125

The above equipped with The "Valveless" Gasoline Marine Motor, the most simple Motor on the market. Small weight. Large power. Perfect control. Price Motor Complete \$75.

F. W. SHERMAN, 16-18 Exchange Street,
Buffalo, N. Y.

Write for catalogue. Agents Wanted



11-foot Special

Folding Canvas Boats

were not satisfactory until the

KING

was produced. It's a revelation in boat construction, nothing like it ever made. *Nonsinkable. Can't tip over. Puncture Proof,* wear longer than a wooden boat. No repairs. No cost for storage, always ready, folds into a small neat package, carry by hand,

used by the U. S. Navy. They are simple, wonderful. A thoroughly patented article. Beware of imitations. Made only by ourselves. *A catalog of 100 engravings and 400 testimonials sent on receipt of 6 cents.*

Bottom Boards rest on the frame, not on the canvas, ribbed longitudinally and diagonally. They are *stiffer and safer* than a Wooden Boat because the lines are fuller, and are much easier to row or paddle.

KING FOLDING CANVAS BOAT CO.

Mention RECREATION.

KALAMAZOO, MICH., U. S. A.

TO AMATEUR PHOTOGRAPHERS

Here is a Chance
to Get a
FINE CAMERA EASILY

A 4x5 Weno Hawk-eye film camera listing at \$8, for 5 yearly subscriptions to RECREATION. A No. 3 folding Weno Hawk-eye film camera, listed at \$15, for 10 yearly subscriptions to RECREATION.

These are both neat, compact, well-made and handsomely finished cameras, capable of doing high-class work.

*Sample copies for use in canvassing
furnished on request.*

Address **RECREATION**

23 West 24th St.

NEW YORK.



DRAWN BY ROY MASON.

A Marble Safety Pocket Axe

is the handiest tool a sportsman ever carried, and a life-saver and comfort-provider in the woods. Hunters, canoeists, yachtsmen, campers, fishermen, all need it and unite in praising its supreme utility. Has a guard which closes over the blade and allows it to slip into hip or breast pocket or hang safely at the belt. Made from the finest steel and superbly finished. No. 1, 16-oz., \$2.50. No. 2, 20-oz., \$2.50. Cheaper grade with wooden handle \$1.50. From sporting goods dealers or direct from us.

A fine catalogue of sporting necessities free for the asking. Ask for catalogue A

MARBLE SAFETY AXE CO.,

GLADSTONE, MICHIGAN, U. S. A.

RECREATION is steadily growing in favor in Toronto, and I have hopes of obtaining many subscribers.

Geo. Lee, Toronto, Can.

RECREATION is the best sportsmen's magazine in the world.

S. J. Engleson, Watson, Minn.

"An ounce of tobacco, please."

"Which sort?"

"Doesn't matter; it's for a blind gentleman."—The Sketch.

Everyone is pleased with RECREATION, and especially with your fight on the game and fish hogs.

Robt. Searcy, Eufala, Ind. Ter.



ACME FOLDING BOAT CO., MIAMISBURG, O.

Send for catalogue of our full line of Folding Canvas Boats and Canoes, which have been adopted by Governments of United States, Canada and England. Just filled an order for U. S. Government who prefer our boats. Received medal and award at Chicago World's Fair. If you investigate we will get your order. Mention RECREATION.

Acme Folding Boat Company, Miamisburg, O.

A SPORTSMAN'S BOAT Mullins' "Get There" Steel Duck Boat



14 ft. long, 36-inch beam.

PRICE, \$20

Crated on cars Salem.

Endorsed by Thousands of Sportsmen. Air Chamber each end. Always ready. No repairs
Send for handsome free book. Mention RECREATION.

W. H. MULLINS, 228 Depot Street, Salem, Ohio

ANOTHER GREAT OFFER TO AMATEUR PHOTOGRAPHERS

A 4 x 5 SERIES 1 KORONA CAMERA
LISTED AT \$12.50, FOR 8 YEARLY SUBSCRIPTIONS TO *RECREATION*;

A 5 x 7 SERIES 1 KORONA CAMERA
LISTED AT \$18, FOR 12 YEARLY SUBSCRIPTIONS;

A 4 x 5 SERIES 2 KORONA CAMERA
LISTED AT \$18.50, FOR 14 YEARLY SUBSCRIPTIONS;

A 4 x 5 SERIES 3 KORONA CAMERA
LISTED AT \$21, FOR 18 YEARLY SUBSCRIPTIONS;

A 4 x 5 SERIES 4 KORONA CAMERA
LISTED AT \$25, FOR 20 YEARLY SUBSCRIPTIONS;

A 4 x 5 SERIES 5 KORONA CAMERA
LISTED AT \$36, FOR 30 YEARLY SUBSCRIPTIONS.

*SAMPLE COPIES, FOR USE IN CANVASSING,
FURNISHED FREE*

ADDRESS

R E C R E A T I O N

23 WEST 24TH STREET, NEW YORK CITY

Something Special — Playing Cards Free:—To each person sending me \$1 for one year's subscription to RECREATION, or sending it direct to be placed to my credit, I will forward, all charges prepaid, a pack of elegant gold edge playing cards. These are no cheap second quality cards but first quality, of extra selected stock, highly enameled and polished, fancy set pattern backs, each pack wrapped in handsome glazed wrapper and packed in strong telescopic case.

L. J. Tooley, 141 Burr Oak St.,
Kalamazoo, Mich.

Visitor—You must have a remarkably efficient board of health in this town.

Shrewd Native—You are right about that.

"Composed of scientists, I presume?"

"No, sir. Scientists are too theoretical."

"Physicians, perhaps?"

"Not much. We don't allow doctors on our board of health; nor undertakers, either."

"Hum! What sort of men have you chosen?"

"Life insurance agents."—New York Weekly.

I am glad to see your magazine increasing in circulation. It is the only real sportsmen's magazine published.

Percy McGhee, El Paso, Tex.

SMALLEY

MARINE GAS ENGINES

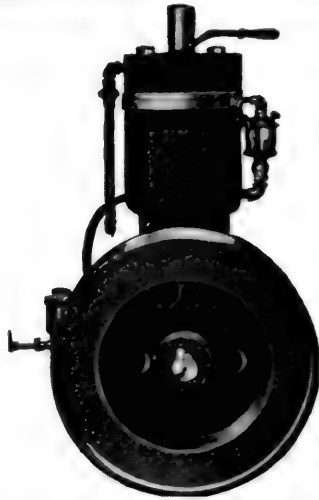

Designed for use in any kind of a boat requiring from 1½ H. P. to 20 H. P. Either single or double cylinder. Simple, mechanical, handsome, durable, positive, economical, and moderate priced. Our speed control, propeller equipment, and many other features should be investigated. **OUR NEW PLANT** is the largest in the world devoted exclusively to the manufacture of Marine Gasoline Engines. We operate our own pattern, foundry, forge, and machine departments. We manufacture every part of our engines, from fly wheel to propeller.

Every engine is connected to its propeller and given an actual water test before placed in purchaser's hands.

SEND FOR ILLUSTRATED CATALOGUE. ADDRESS DEPT. C
Smalley Motor Co., Ltd., Bay City, Mich., U.S.A.

THE LATEST, SAFEST AND BEST CANVAS BOAT

Is what we offer you. A Boat built on modern lines that will prove a pleasure to own and use. Selected materials used throughout, and it comes to you **guaranteed** the best. A handy and safe boat for fishing and shooting. Send 4 cents in stamps for catalogue and reliable testimony.

Mention RECREATION.

LIFE SAVING FOLDING CANVAS BOAT CO.

Kalamazoo, Mich.



Latest patent and improved Canvas Folding Boat on the market. Puncture proof; Tempered steel frame. No bolts to remove. Folds most compact of any boat made.



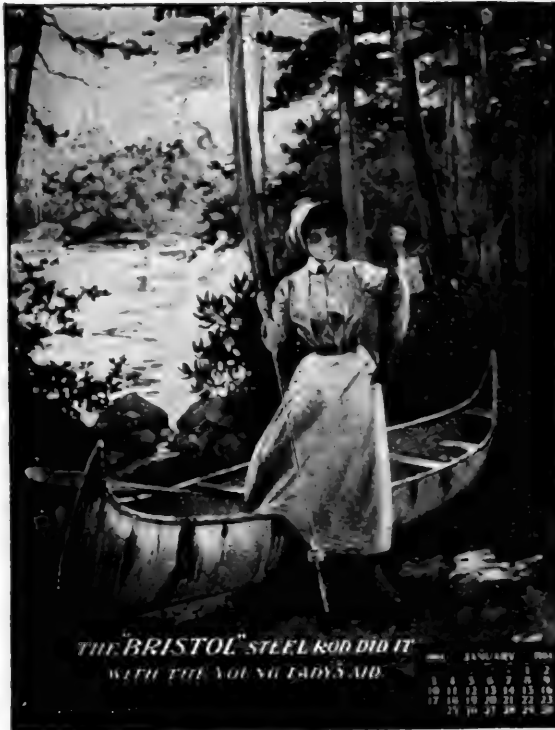

The "Bristol" Calendar

THIS illustration gives but a faint idea of our beautiful calendar, which is printed in ten colors, making it a handsome and striking design. Hang one in your office, den or home, and when you want a fishing rod be sure to get a "BRISTOL." Sold by all dealers. Calendar sent to any address on receipt of ten cents (stamps or silver) to cover cost of mailing provided you mention this magazine.

Ask for Catalog "D," describing 25 styles of "Bristol" Steel Fishing Rods—it is free.

The Horton Mfg. Co.
Bristol, Conn., U. S. A.

Fay & Bowen Motors and Launches

Operated by Gasoline Vapor

The Fay & Bowen Marine Motor is a revelation to those who have used others. Reliable, safe, durable and easy to operate. Remarkable speed control. Best of all it starts when you start it. No handle or crank is used.

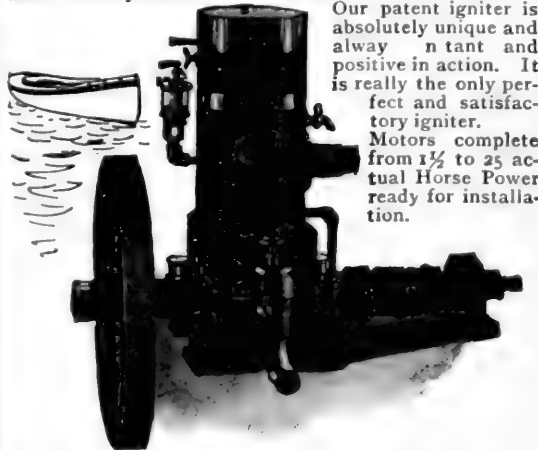

Our patent igniter is absolutely unique and always instant and positive in action. It is really the only perfect and satisfactory igniter. Motors complete from 1 1/2 to 25 actual Horse Power ready for installation.

We also build a line of the finest launches afloat, complete and with our motor installed and all ready to run. We make these in either the usual round stern model or our flat stern torpedo model in lengths from 18 to 35 feet. We can furnish large cabin launches on special order. For excellence of workmanship and beauty of finish and design our boats are unsurpassed. Ask for description of our fast torpedo outfits.

Send for Catalogue and live testimonials from satisfied customers. Our customers are our best advertisers.

Fay & Bowen, 28 Mill St., Auburn, N. Y.

Small Profits—Quick Sales

TROUT FLIES



for trial—send us

- 15c for an assorted sample doz. Regular price, 24 cents. **Quality A Flies**
- 30c for an assorted sample doz. Regular price, 60 cents. **Quality B Flies**
- 60c for an assorted sample doz. Regular price, 84 cents. **Quality C Flies**
- 60c for an assorted dozen Regular price 84 cents. **Bass Flies**

SPLIT BAMBOO RODS

Fly Rods 10 feet, 6 ounces **57 cents** Bait Rods 9 feet, 8 ounces
With cork grip and extra tip, in wood form

THE H. H. KIFFE CO.
523 Broadway, New York City

Catalogs of any of above goods free on application.
Mention RECREATION.

Free: If you send your subscription to RECREATION through me or direct to the office to be placed to my credit, I will send you, free of charge, any one of the articles mentioned below:

Shot gun bench crimper, sells for 75 cents, in 10-12 16-20 gauge.

Shot gun cleaning rod, three attachments, sells for 50 cents, in 10-12 16 gauge.

Micrometer powder and shot measure, adjustable, and for both black and smokeless powder, sells for 65 cents.

U. S. Government rifle cleaner, any caliber, with attachments, sells for 60 cents, packed in neat canvas bag.

A duck, snipe or turkey call, sells for 75 cents each, best made.

A hand painted sporting picture, suitable for framing, and just the thing for your den, worth \$1.50.

"Hunting in the Great West," by G. O. Shields. H. S. Hill, 815 11th Street, N. E., Washington, D. C.

HAVE YOU A FRIEND
ANYWHERE IN THE WOODS,
IN THE MOUNTAINS
OR ON THE FARM,
WHO LONGS FOR SOMETHING TO READ
IN THE LONG WINTER EVENINGS, OR IN
THE LONG SUMMER DAYS?
SEND HIM RECREATION.
IT WILL PLEASE HIM A WHOLE YEAR
AND HE WILL RISE UP AND CALL YOU
BLESSED.
AND IT ONLY COSTS YOU \$1.

Bridgeport, Conn.

The Peters Cartridge Co.,
Cincinnati, Ohio.

Dear Sirs: Your action with regard to RECREATION would certainly convince the average reader that the criticism complained of must have hit hard; in fact, was true.

Harvey C. Went.

RECREATION has given me many pleasant hours. Its views and principles are in direct line with my ideas. Sportsmen the country over should be grateful for your earnest, fearless work to save the game.

C. Tinker, Moniteau, Pa.



As the
Body is bent, so are
PRESIDENT
Suspenders
inclined.

Fit the wearers every movement. Metal trimmings cannot rust—no leather to soil the shirt. Satisfaction, a new pair or your money back. Price 50c and \$1.00 at dealers or by mail.

THE C. A. EDGARTON MFG. CO.,
Box 219, Shirley, Mass.



Famous Navajo Weavings eagerly sought by collectors, and bought at \$50 to \$250, are not equal in brilliance of coloring or harmony of design to our Indian Blankets. For decorating cosy corners they have historical interest and artistic value rivaling the famous rugs of Turkey; most luxurious for slumber and couch robes, baby blankets, outing, travel and athletics. Price \$5—remittance with order. Express prepaid anywhere in U. S. Money refunded if unsatisfactory. Book K showing patterns and colors, free.

AMERICAN INDIAN
BLANKET MILLS,
Jacksonville, Ill.



MATTHEW I. FOX

1123 BROADWAY

Madison Square and 25th Street

TAILOR AND IMPORTER

I refer by permission to the editor of RECREATION

Webber's Hand-Knit Jackets

(Look for Webber's Name on Collar Band)



WEBBER'S No. 4



WEBBER'S HUNTING JACKET

Webber's Hand-Knit Jacket No. 4. "A New One," made of Zephyr yarn, very soft and woolly, medium heavy weight, very elastic. The Jacket for Spring and early Summer. This jacket is not made for shooting particularly but for all outdoor purposes. Order one and if not satisfied return it and get your money back. **Price each, \$6.50**

Webber's Hand-Knit Hunting Jacket, Medium heavy weight, - - - - - each \$4.00

Webber's Hand-knit Alaska Jacket, made with strap across throat, lined pockets and extra heavy, each \$5.00

Mr. Geo. F. Webber, Detroit, Mich.

Portland, Maine, Dec. 28, 1903.

Dear Sir:—Referring to the hunting Jackets purchased from you this Fall, we beg to say that the sportsmen are delighted with them. They certainly fill a long felt want.

We expect to have a still larger sale on them next season than we did this year.

Yours truly,

T. B. DAVIS ARMS CO.

Mr. Geo. F. Webber, Detroit, Mich.

Portland, Oregon, Dec. 16, 1903.

Dear Sir:—We have just wired you to duplicate our order for 9 dozen shooting jackets and concerning this would say we wish them made in the same colors and sizes as our order No. 4201. We have found these jackets to be most excellent sellers and in fact they are the best of the kind we have ever sold. They are practically indispensable for a trapshooter and are also used exclusively by local duckshooters here as a warm garment worn under the ordinary hunting coat. They not only afford protection from the cold but the pockets are a great feature as the shooter always has sufficient quantity of shells at his command.

Yours truly,

HONEYMAN HARDWARE CO., per A. J. Winters.

If your dealer does not handle them send me the price and I will send you a jacket, express prepaid, and if not satisfactory, return the jacket and I will return your money.

GEO. F. WEBBER

MANUFACTURER
Station A

DETROIT, MICH.

PATENTS

promptly obtained OR NO FEE. Trade-Marks, Caveats, Copyrights and Labels registered. **TWENTY YEARS' PRACTICE.** Highest references. Send model, sketch or photo. for free report on patentability. All business confidential. **HAND-BOOK FREE.** Explains everything. Tells How to Obtain and Sell Patents, What Inventions Will Pay, How to Get a Partner, explains best mechanical movements, and contains 300 other subjects of importance to inventors. Address,

H. B. WILLSON & CO. Patent Attorneys
786 F Street, N. W., WASHINGTON, D. C.

The Harrington & Richardson single gun received. It is a fine specimen, and I feel almost guilty in accepting it from one who devotes so much time and energy to protecting our game. If we had had a few Shields years ago buffalo would still roam our Western plains.

J. D. Snyder, Lowell, Ohio.

I have been reading RECREATION but 8 months, nevertheless I have become more firmly attached to it than I have to any other publication.

B. C. Bradley, Northville, Mich.

IF YOU WOULD LIVE NEXT TO NATURE READ RECREATION.

When You Get Up In the Night

The Ever Ready Pocket Flash Light

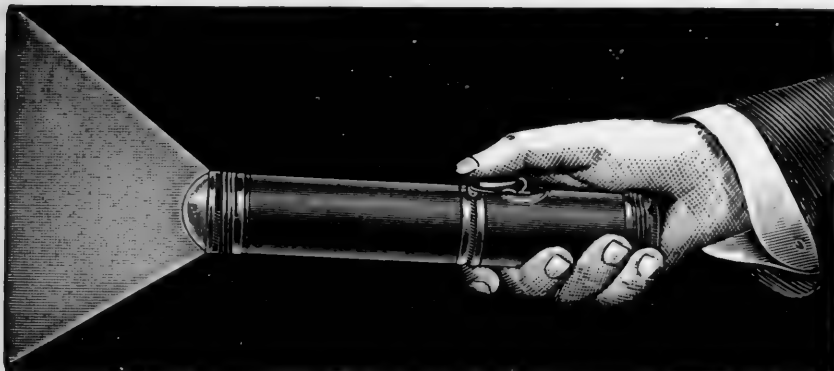

will enable you to find the match box without breaking your neck.

A luxury to every one who camps out, or who lives in the country.

No Wires No Chemicals No Oil, Smoke nor Odor No Danger

Price complete, \$3. Extra battery (No. 10), 30 cents.

The Ever Ready House Lamp

Is a luxury for man, woman or child. It obviates all hunting for matches in the dark. It saves you from falling over the furniture when searching for the water pitcher the other door, or whatever you may seek.

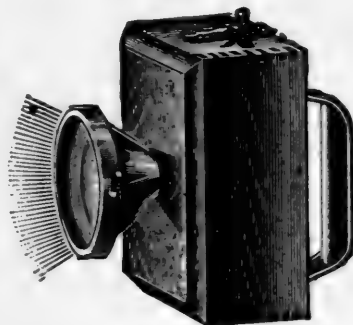

Fine Lens, Highly Polished Reflector, Finely Finished Nickel Trimmings.

Price complete, \$3.

Extra battery (No. 610) 30 cents. Extra bulb, 50c.

The Ever Ready Ruby Electric Lamp



will save the eyes, the patience and the conscience of the amateur photographer who may be fortunate enough to own one.

It is provided with patent catch, so that ruby glass slide can be raised and a strong white light can be had.

One dry battery will last 3 months and costs only 30 cents.

Price of lamp complete, with one battery \$2.50.

Remit by P. O. or Express Money Order.

B. L. SCOTT

23 West 24th Street,

NEW YORK.

I refer, by permission, to the Editor of RECREATION.

Date, _____ 190

G. O. SHIELDS,

Editor and Manager of RECREATION, 23 West 24th St. New York.
Herewith find \$1.00 for which please send me RECREATION one year
beginning with _____ number,

Name, _____

Remit by P. O. or Express Money Order, or New York Draft.

DETACH THIS, FILL OUT, AND SEND IN

JAMAICA

An ideal spot in which to spend a winter's vacation
and avoid all the extremes of the northern climate.

LAND OF THE NEVER-ENDING JUNE

5 days from Boston, 4 days from Philadelphia by the
UNITED FRUIT CO.'S STEAMSHIP LINES

Sailing weekly between BOSTON and PHILADELPHIA and
JAMAICA, the magnificent twin screw U.S. Mail Steamships:

Admiral Dewey

Admiral Sampson

Admiral Schley

Admiral Farragut

Fare for round trip, including stateroom accommodations and
meals, \$75; one way \$40. Send for our beautiful Booklet
whether you contemplate the trip or not.

Division Passenger Agent:
**UNITED FRUIT COMPANY, Pier 5, North
Wharves, Phila. Long Wharf, Boston**
Raymond & Whitcomb Co., Thos. Cook and Sons
and Leading Ticket Offices.

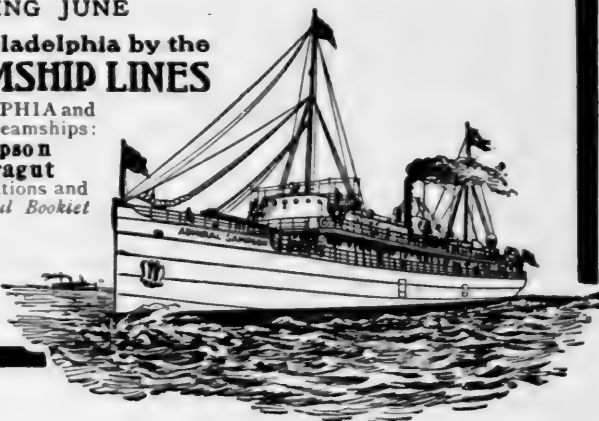

I saw RECREATION at every place I went
in the East. It is the only true sports-
man's magazine published.
W. H. Lumley, Cheyenne, Wyo.

I have been a constant reader of your
estimable magazine for the past 2 years
and enclose \$1 for a new subscription.
Karl Griener, New York City.

APPLICATION FOR MEMBERSHIP IN THE L.A.S.

ARTHUR F. RICE, Secretary L.A.S., 23 W. 24th St., New York.

DEAR SIR: Enclosed \$1 for membership fee for one year.

I certify that I am eligible to membership in the L. A. S. under the
provisions of the constitution, and refer to 2 League members (or to 3
other reputable citizens) named hereon.

Name _____

Street or P.O. Box _____

City or Town _____

References

Detach this, fill out and send in.



Increase Your Income.
Learn profitable poultry raising. Our success in teaching it has been phenomenal. Seven distinct courses by the personal correspondence method. The faculty are practical poultrymen and experienced teachers. All students who have studied with us have made money. This fascinating business, still in its infancy, offers tremendous opportunities for all who begin NOW. Write to-day for illustrated booklet fully describing our various courses of instruction.
COLUMBIA SCHOOL OF POULTRY CULTURE, Box 610, Waterville, N.Y.

"Pigeons and All About Them"

F. M. GILBERT'S latest work. 264 pages, illustrated—strictly up-to-date. The only complete Pigeon Book published in the last twenty years. Cuts of all the best-known varieties. Standards of all varieties. Tells how to build loft, buy, mate, breed, feed, how to ship to customers, how to prepare for shows and ship to shows, how to prevent and cure disease, tells which are the best breeders and feeders, tells best varieties to breed in a city and which in small towns, tells how to mate for color—in fact, it tells just what it has taken the author forty-five years to learn by actual experience. Endorsed by all the leading fanciers in America. Hundreds of letters praise it. Fourth edition now out. To get it promptly send one dollar to **Frank M. Gilbert, Evansville, Ind.**

FOR SALE

LIVE jack rabbits, prairie dogs, squirrels, deer, mandarin, wood and other wild ducks, geese, swan, and other game birds and animals.

CHAS. PAYNE, Wichita, Kansas.

MEXICAN OPAL AND SOMBRERO FREE WITH EACH SUBSCRIPTION TO RECREATION.

To anyone subscribing to RECREATION through me, I will send free a beautiful genuine Mexican Opal as large as a pea, together with a miniature Mexican Sombrero, made of silver and horsehair beautifully dyed. Arthur Thomson, Box 332, San Antonio, Texas.

DO YOU WANT A LENS?

If so, why not get a good one?
And why not get it free of charge?
This is easy.

Any old box will answer the purpose if it does not leak light; but you must have a fine lens to make a fine picture.
You can get

A Royal Anastigmat Lens, 4x5, Series No. 1,

Made by the Rochester Lens Co., Rochester, New York,

**And listed at \$45,
For 20 yearly subscriptions to RECREATION.**

You can get any other lens made by this Company on a basis of one subscription to \$2. of the list price of the lens.

Sample copies of RECREATION for use in soliciting furnished on application.

SPORTSMEN

Learn to Mount Birds, Animals, Heads, Antlers, Tan Furs, Etc.



We teach the art of TAXIDERMISTRY perfectly by mail. The game season is open and you will secure some fine trophies. They deserve a place in your home or office. Why not

BE YOUR OWN TAXIDERMIST?

We teach the art easily and quickly to any one by *Standard Methods*. Expert instructors; reasonable prices. Endorsed by all leading sporting journals, and recommended by the most eminent taxidermists. Our interesting catalog tells all about it, and it's yours for the asking.

Write for one to-day.

The Northwestern School of Taxidermy, Inc. 411A BEE BUILDING OMAHA, NEB.

BUFFALO SKULLS

AND

Buffalo Horn Novelties

Send for Illustrated Catalogue. Mention RECREATION

E. W. STILES

141 Washington St. Hartford, Conn.

Squab Book Free



Squabs are raised in 1 month, bring big prices. Eager market. Astonishing profits. Easy for women and invalids. Use your spare time profitably. Small space and capital. Here is something worth looking into. Facts given in our FREE BOOK, "How to make money with Squabs" PLYMOUTH ROCK

SQUAB CO., 11 Friend St., Boston, Mass.

Taxidermists' Glass Eyes for Stuffed Birds and Animals

Oologists' and Entomologists' Supplies **Materials**

Send 5c. in stamps for catalogue

FRED. KAEMPFER, 88 STATE ST., Chicago, Ill.

Taxidermy work done in all its branches
Mention RECREATION



INDIAN CURIOS

WHOLESALE & RETAIL CURIO DEALERS' SUPPLY DEPOT.

Bead Work, Baskets, Elk Teeth, Mexican Goods, Beads, Fossils, Mirrors, Arrow-Heads, Pottery, Alaska Ivories, Shells, Agates, Photos, Great Stock, Buy Cata. 5c., stamps. Mention RECREATION. If a dealer say so.

L. W. STILWELL, DEADWOOD, SO. DAKOTA



J. BLAKE

Buyer and Exporter of **RAW FURS**

1 WEST THIRD ST.

NEW YORK

Write for price list

FINE MOUNTED GAME HEADS, BIRDS, ETC., for sale at unheard-of prices. Send 10 cents for photos.

JOHN CLAYTON, Taxidermist, Lincoln, Maine

KEEP YOUR FEET Dry and Warm

any doctor will tell you so.

The best way is to wear a pair of



**Thompson-
Quimby
Hunting
Boots**

Get a Pair Now

They will last years and are the cheapest in the end. I refer by permission to the Editor of RECREATION. Measurement blanks and prices on request. Mention RECREATION.

T. H. GUTHRIE

33 William St.

NEWARK. N. J.

The Harrington & Richardson automatic revolver given me as a premium arrived safe. Am much pleased with it. It appears as good as guns costing \$9 to \$12.
I. L. Rich, Tioga, Pa.

The longer I take RECREATION the better I like it.

E. Y. Buzzard, Newberry, Pa.

How is your Muscle?

Would you like to build it up?

How are your Lungs?

Would you like to expand them?

How is your Circulation?

Would you like to improve that?

If so, send me **6 yearly subscriptions** to RECREATION, accompanied by a money order for \$6, and I will send you a new

PROFESSIONAL PUNCHING BAG

made by H. D. CRIPPEN, No. 52 Broadway, New York and listed at \$6.95.

There is a frame with the bag that you can attach to a door casing, a window casing or a wall, or a board fence, or anywhere else you may see fit to put it, and you will thus have a small gymnasium of your own. The Crippen bag is one of the liveliest ever devised, and if you will put 20 minutes a day on it, for a month, you will find a wonderful improvement in your muscle and your health.

Sample copies of RECREATION, for use in canvassing, will be mailed free.

My husband is perfectly delighted with RECREATION, and so am I.

Mrs. A. G. Jones, Kansas City, Kan.

RECREATION was good enough, but it gets better every issue.

W. H. Lumley, Cheyenne, Wyo.

BRADLEY'S ANTI-RUST ROPES!

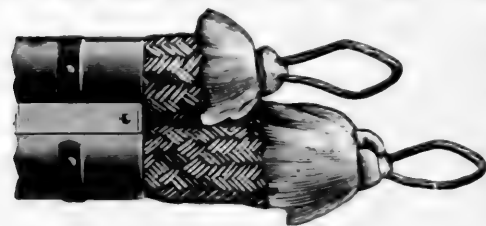

For SHOT GUNS, RIFLES and REVOLVERS. They cannot rust or pit if these ropes are used. No more worrying to keep your fire arms in perfect condition. Sent postpaid, \$1 per set for Shot Guns; 50c. for Rifles; 25c. for Revolvers. Give gauge and length of barrel. Send for circular giving full particulars.

BRADLEY'S SHOT GUN SIGHT

Makes wing shooting easy and certain. Scores greatly increased at trap and in field. Instantly attachable and detachable. Price, post-paid, 50 cents. Send for circular.

Address C. L. BRADLEY, CLARKSVILLE, TENNESSEE.
Mention RECREATION.

THE MALCOLM RIFLE TELESCOPE

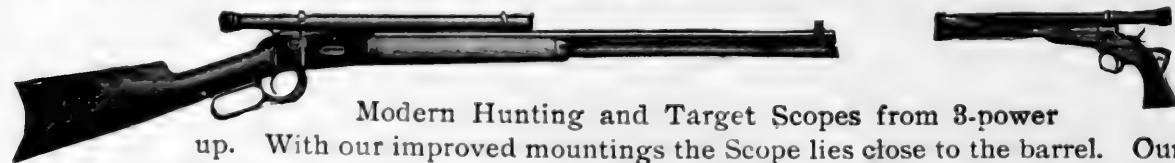

Modern Hunting and Target Scopes from 3-power up. With our improved mountings the Scope lies close to the barrel. Our "Rough Rider" of 3-power is an ideal hunting glass. Our "Bulls Eye" at 5 to 8-power is perfection itself for both hunting and target purposes.

SEND FOR 1903 CATALOGUE

Mention RECREATION.

THE MALCOLM RIFLE TELESCOPE MFG. CO.

F. T. CORNISH, Mgr.



"Collan-Oil"

preserves leather and renders shoes and harness positively

WATERPROOF

Used by the U. S. the Army and Navy and National Guard.

Send 25c. for trial can.

AGENTS WANTED

Write for terms and circulars

J. R. BUCKELEW

Dept. A.

111 Chambers St., N. Y.

Practical Common Sense in 6 Sizes.

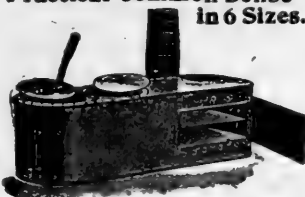

CAMP STOVE

Either with or without oven. The lightest, strongest, most compact, practical stove made. Cast combination sheet steel top, smooth outside, heavy lining in fire

box and around oven, holds its shape, telescopic pipe carried inside the stove. Burns larger wood and keeps fire longer than any other. Used by over 9,000 campers and only one stove returned.

For catalogue giving full particulars, mention RECREATION and address,

D. W. CREE, Manufacturer, Griggsville, Ill.

KOENIG'S SHELL EXTRACTOR.

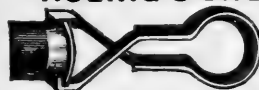

10 Cts. Postpaid.

E. G. KOENIG, NEW JERSEY'S LARGEST GUN HOUSE
SOUTH BROAD ST., NEWARK, N. J.

B. Bernard

Buyer of Raw Furs and Ginseng Root.

150 Blecker St., New York.

Quotations sent on request.

"Yes," said the dentist, "to insure painless extraction you'll have to take gas, and that's fifty cents extra."

"Oh!" said the farmer. "I guess the old way'll be best; never mind no gas."

"You're a brave man."

"Oh! it ain't me that's got the tooth; it's my wife."—Philadelphia Ledger.

All your subscribers here agree that RECREATION is the best sportsmen's journal they ever read.

John J. Weaver, Hampshire, Ill.

The Elita single barrel gun arrived in good condition. I was surprised to find it so much better than I had expected.

C. M. Ambrose, Summerville, Mass.

NEWHOUSE STEEL TRAPS

Made since 1848 by ONEIDA COMMUNITY

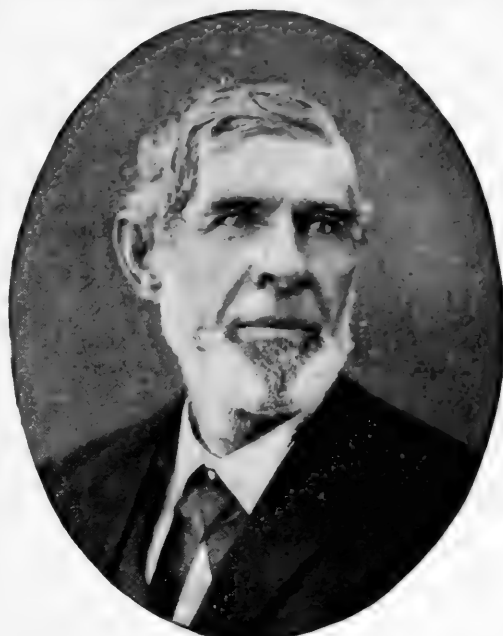

S. NEWHOUSE

(The Old Trapper and Trapmaker)

Fifty years ago this famous old Trapmaker of the Oneida Community would not let a trap leave his hand till he KNEW that it would hold any animal that got into its jaws—even greater pains are taken now than then in selecting the finest steel and rigidly testing every part.

This is why all experienced Trappers insist on having the

"NEWHOUSE"

ELEVEN SIZES. EVERY TRAP GUARANTEED

Illustrated Catalogue Mailed



In addition to regular sizes we make Special Traps for every recognized need. This cut shows our No. 11 Web Jaw NEWHOUSE which makes it impossible for such animals as skunks to escape by gnawing off a leg. Ask for special circular.

ONEIDA COMMUNITY
ONEIDA NEW YORK

Send twenty-five cents for "The Trapper's Guide," telling about the habits of wild animals and how to trap them

SLEEP

IS TIRED NATURE'S
SWEET RESTORER

After a hard day's tramp, you must have

A Good Night's Rest

in order to fit you for the next day's work. Better to sleep on a good bed without your dinner, than sip at a banquet and then sleep on the cold, hard, wet ground. You can get

A Recreation Camp Mattress

of rubber, with valve for inflating, made by the Pneumatic Mattress Co., and listed at \$18.

For 10 Yearly Subscriptions to
RECREATION

Send for Sample Copies

Address RECREATION, 23 West 24th Street, New York

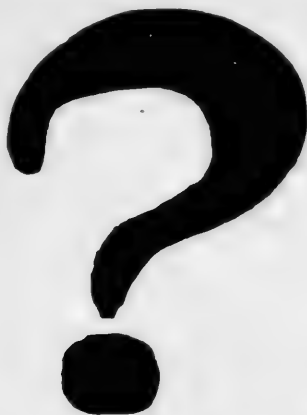

Discriminating sportsmen are enthusiastic over the many novel features of the **SAVAGE 22 CALIBER REPEATER**. It is hammerless, shoots the short, long and long rifle cartridges all in the same arm, and its accuracy alone has placed it in a class by itself.

WRITE TO-DAY FOR CATALOGUE G—FREE

Our 1904 Calendar sent on receipt of ten cents in stamps

SAVAGE ARMS COMPANY

UTICA, NEW YORK, UNITED STATES OF AMERICA
BAKER & HAMILTON, San Francisco and Sacramento, Cal., PACIFIC COAST AGENTS

I have been a regular subscriber to RECREATION for 2 years and think it the best sportsmen's magazine published.

R. W. Hennessy, Burnt Ranch, Cal.

RECREATION is the best sportsmen's periodical published. I wish you success in your war against game hogs.

Harry Atkinson, Fordyce, Ark.

RECREATION leads all the sportsmen's publications.

S. W. Weede, Flatwillow, Mont.

Byer: The boys of Captain Lushman's company want to present him with some little testimonial.

Cutler: How about a nice pocketknife? Here's a beauty, with four blades and a corkscrew.

"Haven't you got any with one blade and four corkscrews?"—Philadelphia Ledger.

"If our combination is illegal," said the capitalist, "I suppose we will have to change it."

"Wouldn't it be easier to change the law?" asked his associate.—Chicago Evening Post.

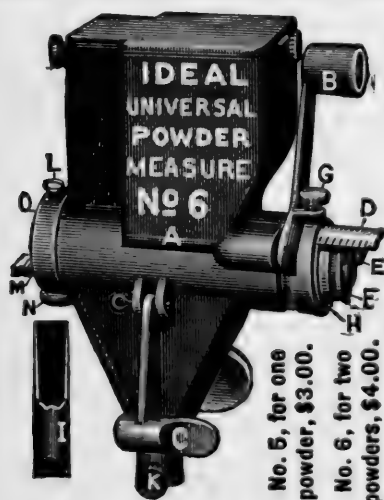

POWDER! POWDER!

All kinds of powder for **Rifles, Pistols** and **Shot Guns**, measured accurately from 1 to 145 grains. 4 different measures in 1. The latest and best tool. Ask your dealer for it.

Every shooter should have 1. Send 3 stamps for **Ideal Hand Book**, 146 pages of information to shooters.

IDEAL MFG. CO., 120 St., New Haven, Conn., U. S. A.

The PHIL B. BEKEART CO., of San Francisco, Cal., Agents for Pacific Coast

When you write kindly mention RECREATION

HERE IS ANOTHER!

If you will send me

30 Yearly Subscriptions

to

RECREATION

I will send you

**A No. 10 Goerz Trieder-
Binocular Field Glass**

Listed at \$38.

Every well-informed man knows the great power of this modern prismatic field glass. It is indispensable to every hunter, and is one of the latest and best on the market.

I have but a few of these instruments on hand and the offer will be withdrawn as soon as the supply is exhausted. Therefore, if you want one

START IMMEDIATELY

Sample copies of RECREATION for use in canvassing furnished
on application

1904 Art Catalog



CONTAINS

**Photographs and Descriptions
Sixteen Guns**

ABOVE CUTS SHOW

No. 3, List Price, \$80.00

No. 2, List Price, 60.00

WRITE FOR SPECIAL PRICES
MENTION RECREATION

Ithaca Gun Company
I T H A C A , N E W Y O R K

WINTER IS HERE

GET A PAIR OF SKATES

For yourself, your best girl or your brother, or for some other girl's brother, or for any one you love, and who is fond of skating

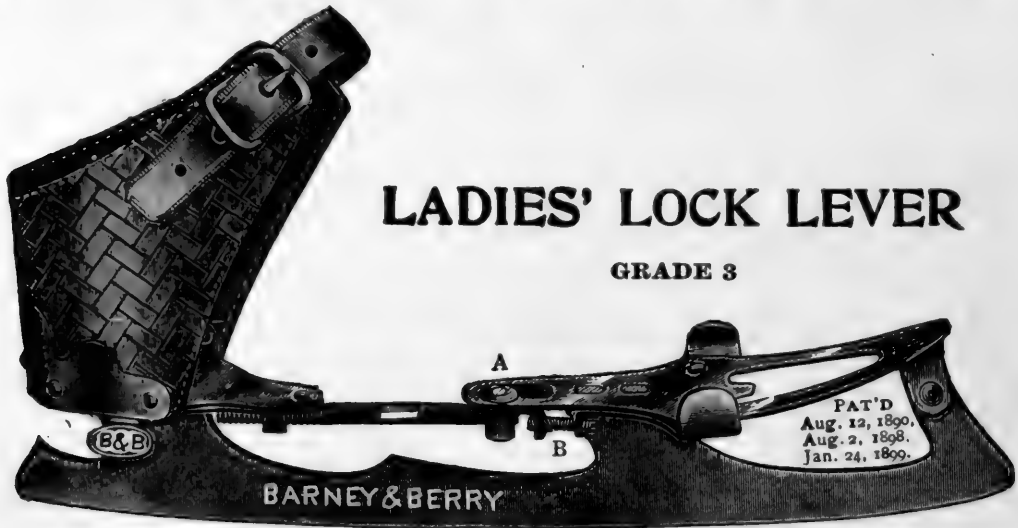

For 5 Yearly Subscriptions to RECREATION

I WILL SEND YOU

A Pair of Lock Lever Skates

OR

A Pair of Ladies' Lock Lever Skates

Grade 3, made by Barney & Berry, Springfield, Mass.



As every skater knows, these are the best skates made in the world. The winter season is here, and you could scarcely select a more appropriate present

FOR A MAN, OR A WOMAN, A BOY OR A GIRL

than a pair of these high-grade skates. Only a limited stock on hand, and when these are gone this offer will be withdrawn.

Sample copies of RECREATION for use in canvassing furnished on application.

ONE OF THE 9
"SYRACUSE"
Built for Business.



COPYRIGHTED 1903

SYRACUSE ARMS CO.

This picture shows the result of a
SINGLE SHOT from a **SYRACUSE**
16 GAUGE

THREES OF THIS KIND ARE HARD TO BEAT

Write for a
Syracuse
CAT.

SYRACUSE
ARMS CO.

SYRACUSE, N. Y.

Mention RECREATION.

No better

POWDER

in the world for winter shooting
than

WALSRODE

Not affected by any CLIMATE.
If you can not get shells in your
neighborhood, write to us.

SCHOVERLING, DALY & GALES
302-304 Broadway, New York

Send 5 cents for Specialty Catalogue

Mention RECREATION

AN IMPORTANT OFFER

For 2 Yearly Subscriptions to RECREATION

I will send you

A RIFLE WICK PLUG

Made by HEMM & WOODWARD, Sidney, Ohio, 30 caliber
up to 50 caliber.

OR

A SHOT GUN WICK PLUG

20 gauge up to 10 gauge

For 3 Yearly Subscriptions to RECREATION

A Pair of Shot Gun Wick Plugs

20 to 10 gauge.

Sample copies for use in canvassing furnished on
application.

Address RECREATION, 23W. 24th St., N. Y. City

HAVE YOU A FRIEND
ANYWHERE IN THE WOODS,
IN THE MOUNTAINS
OR ON THE FARM,
WHO LONGS FOR SOMETHING TO READ
IN THE LONG WINTER EVENINGS, OR IN
THE LONG SUMMER DAYS?
SEND HIM RECREATION.
IT WILL PLEASE HIM A WHOLE YEAR
AND HE WILL RISE UP AND CALL YOU
BLESSED.
AND IT ONLY COSTS YOU \$1.

I have been reading RECREATION for some
time, and think it is the book of all books.
G. H. Harvey, E. Liverpool, O.

RECREATION is O. K. and a good thing,
so push it along.

John R. Burton, Merrill, Ia.



We make a specialty of Featherweights
and Trap Guns with our new
SINGLE TRIGGER

Send stamp
for 1903 Catalogue
Mention RECREATION

D. M. LEFEVER SONS & CO.,

Manufacturers of the "NEW LEFEVER"

Not connected with Lefever Arms Co.

SYRACUSE, N. Y.

Guaranteed
Perfect

Our New
Perfect
Gun Cleaner
By Mail,
30 Cents

H. & R. SINGLE SHOT GUN

Automatic and Non-Ejecting

The cheapest absolutely safe gun, with improvements found heretofore only in the highest priced.

**PERFECT IN MODEL
AND CONSTRUCTION**

**SIMPLEST "TAKE
DOWN" GUN MADE**

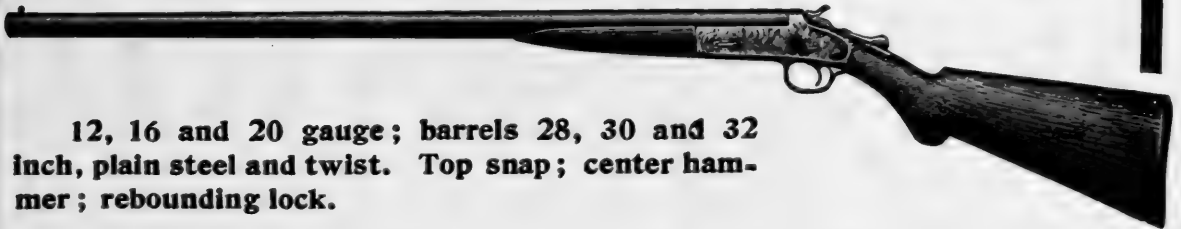

12, 16 and 20 gauge; barrels 28, 30 and 32 inch, plain steel and twist. Top snap; center hammer; rebounding lock.

Your dealer can supply, or we will sell to you direct. Write for Catalog.

HARRINGTON & RICHARDSON ARMS CO.

Dept. R, WORCESTER, MASS.

Makers of H. & R. Revolvers

I don't think a more interesting epitome of true sportsmen's practices could be put in space than is contained in January RECREATION.

Wm. C. Koonse, Columbia, Ala.

RECREATION comes regularly and is the it is the best magazine published. Could not get along without it.

Will Small, S. Coventry, Conn.

Knicker: Do you believe in a college education?

Bocker: Yes; it teaches a boy's father how to take care of his money.—Life.

I have read RECREATION the past 2 years, and am satisfied that it has had a great deal to do with making my doctor's bill light.

T. L. Chapman, Jr., Hoboken, N. J.

THE PARKER AUTOMATIC EJECTOR

The Latest attachment to
The "OLD
RELIABLE"



New York Salesroom, Send for Catalogue. PARKER BROS.,
32 WARREN ST. Mention RECREATION. Meriden, Conn.

A Valuable Present

FOR YOUR WIFE
YOUR MOTHER
YOUR SISTER
OR YOUR BEST GIRL

For 25 Yearly Subscriptions to RECREATION

I will send you a set of

1 DISH AND 12 TOMATO PLATES

made by HIGGINS & SEITER, 50 W. 22d St., N. Y.
LISTED AT - - \$19.50

AND

For 20 Yearly Subscriptions to RECREATION

I will send you a set of

12 Watermelon Plates

Listed at - - \$16.50

[See Illustration]



THESE are fine, thin, white china plates, beautifully hand painted, with pictures of tomatoes and tomato vines, or watermelons and watermelon vines, in natural colors, and each set of plates is enclosed in a case made in an exact imitation of a large tomato or a watermelon.

No more beautiful or appropriate present could possibly be

found for a lady than one of these sets.

You can earn one of them in a few hours, and at the same time earn the everlasting gratitude of the lady to whom you may give it.

Send for package of sample copies for use in canvassing.

Six Books for the Sick What I Learned After 30 Years

Which
shall
I
send?

Book 1 on Dyspepsia.
Book 2 on the Heart.
Book 3 on the Kidneys.
Book 4 for Women.
Book 5 for Men (sealed).
Book 6 on Rheumatism.

No money is wanted.

Simply select the book you need.

It is my experience as a specialist of 30 years. In the book I tell how at last I found a way to reach difficult, deep-seated diseases. Thirty years of earnest, ardent toil in hospitals and at bedsides, made it possible for me to write these books.

The book tells how I perfected my prescription—Dr. Shoop's Restorative. How by scientific experiments I traced out the causes that bring on chronic diseases.

I found invariably that where there was a weakness, the inside nerves were weak.

Where there was a lack of vitality, that the vital nerves lacked power.

Where weak organs were found, I always found weak nerves.

Not the nerves commonly thought of, but the vital organs' nerves. The inside—the invisible nerves.

This was a revelation.

Then my real success began.

Then I combined ingredients that would strengthen—that would vitalize these nerves.

That prescription I called a restorative. It is known the world over now as Dr. Shoop's Restorative. After that I did not fail to cure one in each hundred. In the extremely difficult cases, my failures for five years were only one in each forty treated. I found cancer incurable. Cancer is for surgery, not medicine.

Then how to get this prescription to the sick ones everywhere, was my thought.

I must announce it in the public press. But, thought I, will they realize the real truth of my discovery—the real power of Dr. Shoop's Restorative? Then a way came to me—like an inspiration.

"I will offer it to the sick on trial," said I. "Then they will know I am sincere."

I wrote a reliable druggist in each city and village in America.

I got their agreement to co-operate with me.



Now by any sick one
Dr. Shoop's Restorative
Can be taken at my risk.

For a full month I will let you use it entirely at my risk. Send no money. Just write me for the book you need. When I send it I will tell you of a druggist near you who will permit the month's trial. Take the Restorative a month. Then decide. If you say to the druggist, "It did not help me," that will relieve you of any expense whatever. He will bill the cost to me.

This is my way of clearing your mind of all doubt as to what Dr. Shoop's Restorative can do. No matter how prejudiced you can not dispute this absolute security I offer. You can not resist an offer like this if you are at all sick. If you have a weakness, write me. If you can't do things like you used to do them, tell me about it. Write in confidence. As a physician I will tell you a way to help.

Get my book now—to-day.

Address Dr. Shoop, Box 5214, Racine, Wis.

Mild cases not chronic, are often cured by one or two bottles. At druggists.

Left From Our FIRE SALE. A few
High Grade Hammerless **GUNS**

SCOTT, GREENER

LANG and others

12, 16 and 20 Bores. Trap and some very light weights. 26, 28 and 30 inch

which we are closing out at **Greatly Reduced Prices—BARGAINS.**

☞ Descriptive List with full description mailed on receipt of 2 stamps.

Also a lot of **AMERICAN HAMMERLESS DOUBLE GUNS**, pistol stock, through cross bolt, all improvements twist barrels, 28 and 30 inch, 12 bore, closing out at **\$19.50 each**

These are entirely new, and bargains.

☞ Send 2 stamps for full list.

Mention RECREATION

Also our **Special Swedish Leather Jackets** in demand at this season

REDUCED PRICES IN A

L
o
o
t **Double Breech Loading Hammer Guns** \$8, \$10, \$12, c
t

WM. READ & SONS, 107 Washington Street, Boston

ESTABLISHED 1826

Send 2 Stamps for Lists

Your Job Printing Free: For 1 yearly subscription to RECREATION I will give you free either 100 envelopes with your return card printed thereon, or 100 visiting cards. Send stamp for samples. Henry J. King, Fultonville, N. Y.

Wanted: RECREATION magazines from first publication up to December, 1899. Write what you have, also price. W. O. Hall, L. B. 11, Kittery Point, Me.

For Sale: A 5x7 Bausch & Lomb Plagmat Lens. In perfect condition; used only a few weeks. Cost \$45. Will sell for \$20. Address S. G., care RECREATION.

For Sale:—Ithaca hammerless shotgun, 12 gauge, No. 2 quality, almost new. Price \$35. A. W. Houghton, Marion, O.

Composer—Yes, my opera will be sung when the works of Handel, Mozart, Beethoven, and Wagner are forgotten.

She—Yes, but not until then.—Indianapolis Journal.

Enclosed you will find \$1 for which please send me RECREATION for another year. It is something I can not do without. Long may it live to down the game hogs.

W. J. Blackwell, Ruffin, N. C.

RECREATION is certainly the best magazine of its kind printed. I like the way you give it to the game and fish hogs.

F. B. Garnsey, Grindstone, N. Y.

THE
DAVENPORT
1904 MODELS.

The Productions of
over 50 YEARS of
Practical Experience.

Catalogue
Free



Mention
RECREATION

The W. H. Davenport Fire Arms Co., Norwich, Ct.

1. The first part of the document is a list of names and addresses of the members of the committee. The names are listed in alphabetical order, and the addresses are given in full. The list includes the names of the members of the committee, the names of the members of the sub-committee, and the names of the members of the advisory committee. The addresses are given in full, including the street, city, and state.

17
A NEW
E W

17
A NEW
E W

17
A NEW
E W

17
A NEW
E W

17
A NEW
E W

RECREATION

OFFICIAL ORGAN OF THE LEAGUE OF AMERICAN SPORTSMEN



AMATEUR PHOTO BY C. O. SPEIGHT.
SCREECH OWL

One of the 20th Prize Winners in RECREATION's 7th Annual Photo Competition.

PUBLISHED BY G. O. SHIELDS (COQUINA)
23 WEST 24TH ST., NEW YORK

Tale of Alaskan Hardships; With full page drawing by
W. H. LAWRENCE



THE OLD WAY

THE BOAT as pictured below in every detail—length 15½ feet, beam 4 feet, with ¾ h. p. Blomstrom gasoline engine,

\$100

*So simple a child can operate
with entire safety*

Catalogue D, including Marine Gasoline Engines of from ¼ to 80 horse-power at corresponding prices, free on request.

THE C. H. BLOMSTROM MOTOR CO.
1284-1294 River Street Detroit, Mich.

[From the Chicago Journal, May 7th, 1903]

At last an honest soul has put a 15½ foot launch with gasoline engine—4 foot beam—within the reach of the masses.

THE NEW WAY



RECREATION

Copyright, December, 1903, by G. O. Shields

A Monthly Magazine Devoted to Everything the Name Implies

\$1.00 A YEAR.
10 CENTS A COPY.

G. O. SHIELDS (COQUINA),
Editor and Manager.

23 WEST 24TH STREET,
NEW YORK

CONTENTS OF THIS NUMBER

	PAGE.
The Other 2 Men Pushed on with 4 Dogs	FRONTISPIECE
A Tale of Alaskan Hardships.....	W. J. 171
Where the White Goats Get Their Salt. Illustrated.....	G. O. SHIELDS 175
The Sage Grouse.....	CHARLES S. MOODY 177
Bears and Things.....	FRANK MOSSMAN 179
An Eye for An Eye. Illustrated.....	MELEAGRO 181
The Modern Squirrel Hunter. Poem.....	JOHN L. WOODBURY 183
A Tale of the Woods.....	CHARLES T. MURRAY 184
A Florida Fishing Party.....	E. M. LEEBE 187
Captain Joe Muffrau. Poem.....	H. W. BRADLEY 188
Baiting a Bear.....	WILLIAM J. LAMPTON 189
Early Days on the Yakima.....	J. E. NEWTON 191
How Sam Flynn Was Cured of Office Seeking.....	JENNIE P. BUFORD 193
The Trumpeter Swan. Illustrated.....	ALLEN BROOKS 194
How I Lost My Gun.....	OTTO VON STOCKHOUSEN 195
Signs of Spring. Poem.....	E. C. M. RICHARDS 196
The Dissolution of Abijah Dusenbury.....	DR. G. A. MACK 197
On a Russian River. Illustrated.....	BARON PAUL TCHERKASSOV 199
My Trip to Wood's Canyon.....	EDWARD CASHMAN 201
The Regeneration of Windy.....	CHARLES A. HARMON 205
Fishing After Dark.....	MAY MCHENRY 207
His Change of View. Poem.....	CANDICE A. BRAMBLE 208
A Pilfering Grizzly.....	FRANK R. GROVER 209
From the Game Fields..... 210	Forestry..... 236
Fish and Fishing..... 217	Pure and Impure Foods..... 239
Guns and Ammunition..... 221	Publisher's Notes..... 242
Natural History..... 229	Editor's Corner..... 244
The League of American Sportsmen..... 232	Amateur Photography..... 250

Entered as Second-Class Matter at New York Post Office, Oct. 17, 1894.



**YOU CAN'T
LOSE THEM**
If you wear

a Key Chain attached with
WASHBURNE'S
Patent Improved
FASTNERS

Little and inconspicuous, but with a bulldog grip
that never loosens by accident.

Key Chain and Ring - - - 25c. } Sent
Cuff Holders - - - - - 20c. } Post
Scarf Holder - - - - - 10c. } Paid.

Illustrated Catalogue of other novelties on request.
Sold Everywhere.

AMERICAN RING CO.
Dept. 44, Waterbury, Conn.

Sore Throat

Hoarseness, Quinsy, Tonsillitis
Laryngitis and other throat
troubles quickly relieved
and promptly cured
by the use of

Hydrozone

This scientific germicide is used and endorsed by leading physicians everywhere. It is *absolutely harmless*, yet a most powerful healing agent.

By killing the germs that cause these diseases, without injury to the tissue, Hydrozone cures the patient. Sold by leading druggists. If not at yours, will send bottle, prepaid, on receipt of 25 cents.

Prof. Charles H. Hareland

F-59 Prince Street, NEW YORK
FREE.—Valuable Booklet on How to Treat Diseases.

For Hunters, Anglers, Prospectors, Ranchmen, The Press Button Knife

IS THE THING.

A single pressure of the button opens it. It locks open, cannot close on the fingers, saves the finger nails, has 2 blades hand-forged from Wardlow's best English steel, and is in every respect as good a knife as can be made. Ladies' and Gentlemen's sizes in Stag Shell or Ivory handles, including moisture-proof Chamois case securely mailed to any address for **75 CENTS.**

Send for catalogue K for description and prices of other styles.

**THE
NOVELTY
KNIFE CO.**

**426 East 52d Street,
NEW YORK.**

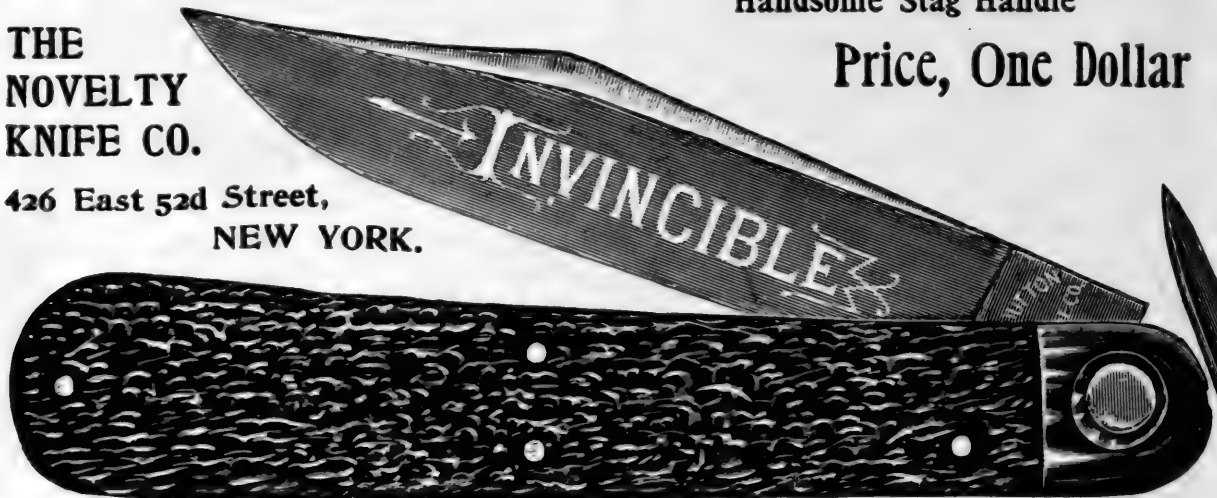

And all others who go
into the Woods or Hills

Our 5-inch Press Button Hunting Knife can not be excelled. Can be opened with one hand, and will not open or close accidentally.

Handsome Stag Handle

Price, One Dollar



Camping Out

Camping may be pleasant, or disagreeable or dangerous. The equipment has much to do with it. Expense may be large and results unsatisfactory, or small with good results. "KNOW-HOW"—what to take, what to leave—has most to do in insuring the comfort, pleasure and safety of an outing expedition, be it to explore untraveled mountains, or to find the north pole, or just to spend a month in the woods.

Our business is to "KNOW-HOW." Our success leads us to believe that we have learned our business.

We manufacture and sell everything for outfitting camping parties. Let us send our Catalogue R, or better still, call on us, if you contemplate "smelling burning wood" before an open tent in the shadow of the woods.

ABERCROMBIE & FITCH

314-316 Broadway, New York

The
OLDSMOBILE
GOES
In the CROWDED
CITY and
EVERYWHERE

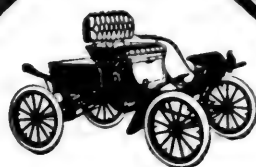

On any busy street count the number of Oldsmobiles you see. If there are not more than twice as many as any other make of motor car, you are living in a very exceptional city.

Oldsmobile progress did not stop with bringing out the Standard Runabout—a car that has sustained its reputation at home and abroad in open contest with all others.

Oldsmobile perfection has been applied to other types of motor cars, and at any of our selling agencies in the larger cities, you can see our

Oldsmobile Standard Runabout
 Price \$650

Oldsmobile Light Tonneau Car
 Price \$950; without Rear Seat, \$850

Oldsmobile Touring Runabout
 Price \$750

Oldsmobile Light Delivery
 Wagon
 Price \$850

For further particulars about the Oldsmobile line, see our nearest selling agent, or write direct. A captivating automobile story, "Golden Gate to Hell Gate," free on request to Dept. 83

Olds Motor Works, Detroit, U. S. A.

Member of the Association of Licensed Automobile Manufacturers



20th CENTURY LAUNCHES

Steam Yachts. Sail Yachts. Row Boats. Canoes

Send 20 cents for catalogue giving the truth in detail about the best boats built, our **Automobile Launch**, our new up-to-date plant, our one lever control, jump spark, under water exhaust, self-oiling motor, our \$150.00 launch and other 1904 creations. Agencies in all principal cities. Satisfaction guaranteed. Address,

Racine Boat Mfg. Co., (Riverside), Muskegon, Mich.



THE works of the Racine Boat Manufacturing Co., of Racine, Wis., were burned down last May. An entirely new plant has been established at Muskegon, Mich. They are now at work on their 1904 product and new catalogue will be ready for distribution March 1st.

In writing for same please mention Recreation. The Racine Boat Manufacturing Company's Ad will occupy this entire page in April and subsequent issues of Recreation.

Wherever a Wheel Will Turn
a CADILLAC Will Go

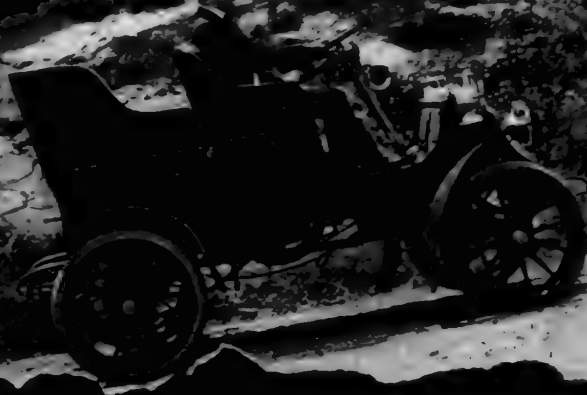

The Cadillac is the only automobile embodying broadly utilitarian principles. The picture above shows a strong, stylish, powerful touring car that will accommodate four people comfortably; that is as smooth-running and reliable as any high-priced machine. Remove the tonneau, and it becomes a smart runabout—superior to every other in simplicity and ease of operation; equalled by none in speed, strength, appearance or mechanical excellence.

The

CADILLAC

is an automobile absolutely unique in perfection of design and carefulness of construction. No other is so easily and perfectly adaptable to the various requirements of business and pleasure; no other has so many points of intrinsic superiority. Improved wheel steering-gear; new departure in brakes; positive ignition. Transmission is simple, noiseless and "fool-proof." When car is running on high gear the speed can be regulated on ordinary roads by throttle alone. Engine develops eight horse-power, runs without vibration, and will drive steadily, surely, powerfully, "wherever a wheel will turn." Model A, 1904, with detachable tonneau, seating four, all facing forward, \$850.00; without tonneau, \$750.00. All 1904 Cadillacs are equipped with Clincher Tires.

Our free illustrated booklet K gives address of agency nearest you, where the Cadillac may be seen and tried.

CADILLAC AUTOMOBILE CO., Detroit, Mich.

Member Association of Licensed Automobile Manufacturers.

AUTO-BOATS

The latest fad



Speed 12 to 35 miles.
 Sizes 30 to 70 feet, using
 our own new design, the

“Speedway” Gasolene Automobile Motor

We also build The Only Naphtha Launch, Electric Launches, Alco
 Vapor Launches, Steam and Sail Yachts.

Our showrooms contain 100 finished launches to select from.

Send 10 cents in stamps for new catalogue of auto-boats, naphtha or alco vapor launches

Gas Engine & Power Co. and Charles L. Seabury & Co., Consolidated
 MORRIS HEIGHTS, NEW YORK CITY

Down Town Office, 11 Broadway

Chicago Office, 1409 Michigan Ave.



Model "H"

here illustrated is a strong, light Touring Car, having an 81-inch wheel base. It starts from the seat, is equipped with four elliptic springs, detachable tonneau, brass side lamps and horn. It is built to run easily and ride smoothly, and has no equal at the price, and few at double the price. Simple in construction and powerful in operation are

Rambler

Touring Cars

Six different models \$650.00 to \$1350.00 at the factory.

Model "H" \$850.00 at the factory. Rambler Delivery Wagons, with detachable top, \$850.00 at the factory. **Model "L"** fitted with canopy top, beveled plate glass swinging front and side baskets, \$1,350.00 at the factory.

Our new illustrated catalogue shows each different style of car and tells its special points of merit. Shall we mail you a copy?

Thomas B. Jeffery & Company,
Kenosha, Wis., U. S. A.

Chicago Branch, 304 Wabash Ave.
Boston Branch, 145 Columbus Ave.



THE GOLDEN GATE



THE Fast Trains

ARE VIA THE
**UNION
PACIFIC**

If you want a quick and pleasant trip, select the Union Pacific, its trains from Omaha reaching the Pacific Coast.

16 HOURS QUICKER

Than any other line

**No Change of Roads
No Change of Cars
No Detours**

**"THE OVERLAND ROUTE"
ALL THE WAY**

**Be sure your Ticket reads
over the UNION PACIFIC**

Full information cheerfully
furnished on application to

R. TENBROECK
General Eastern Agent
UNION PACIFIC RAILROAD
287 Broadway, NEW YORK CITY

Sent on Approval

TO RESPONSIBLE PEOPLE

Laughlin

Fountain Pen

Guaranteed Finest
Grade 14k.
SOLID GOLD PEN.

To test the merits of
RECREATION

as an advertising medium
we make this grand special offer, your choice of

These
Two
Popular
Styles
For Only **\$1.00**
Postpaid
to any
Address

(By Registered mail 8 cents extra)

Holder is made of finest quality hard rubber, in four simple parts, fitted with very highest grade, large size 14k, gold pen, any flexibility desired—in feeding device perfect.

Either Style—**RICHLY GOLD MOUNTED** for presentation purposes, \$1.00 extra.

Grand Special Offer

You may try the pen a week; if you do not find it as represented, fully as fine a value as you can secure for three times the price in any other make, if not satisfactory in every respect, return it and we will promptly refund your money.

Illustration on left is full size of Ladies' style; on right, Gentlemen's style. Lay this **RECREATION Down and Write NOW.**

Safety Pocket Pen Holder sent free of charge with each Pen.



ADDRESS :

Laughlin Mfg. Co.

424 Griswold St., DETROIT, MICH.

BRUIN
AND THE
NORTHERN PACIFIC
TRADEMARK are
closely related.
The railway leads
direct to
YELLOWSTONE
PARK

Where Bruin is
seen in his glory.

The Park Season extends
from June 1st. to Sept 30th
and **RATES ARE GREATLY**
REDUCED and **NEW HOTELS**
have been built.

Send six cents for
"WONDERLAND"

CHAS. S. FEE, G.P.&T.A. ST. PAUL, MINN.



THE FOCAL POINT

WABASH

VIA THE WABASH

C.S. CRANE G.P.&T.A.
ST. LOUIS

KANSAS CITY
OMAHA
DES MOINES
ST. PAUL
CHICAGO
PITTSBURG

ST. LOUIS WORLD'S FAIR

SOUTHERN RAILWAY

TO ALL THE PRINCIPAL CITIES AND RESORTS South, Southeast, Southwest, Florida, California, Cuba, Mexico and Central America.

"The Land of the Sky" and "Sapphire Country"

Fullman Drawing and State-room Sleeping Cars: Dining, Library and Observation Cars of the Highest Standard. The Route of the Washington & Southwestern Limited and Sunset Limited New York and New Orleans, Los Angeles, and San Francisco.

The Southern's Palm Limited
New York and St. Augustine.

Write for Descriptive Matter
NEW YORK OFFICES: 271 & 1185 Broadway
ALEX. S. THWEATT, Eastern Passenger Agt.
W. A. TURK, - Passenger Traffic Manager
S. H. HARDWICK, General Passenger Agent
WASHINGTON, D. C.

"She sits forever in the sun."

DENVER,
COLORADO.

Joaquin Miller thus wrote of Denver, and all who have seen it pronounce this one of the most beautiful of modern cities. It is best reached by the

NEW YORK CENTRAL LINES

and their connections. Only one change of cars from New York or Boston to Denver.

Details of rates and trains gladly furnished by any New York Central ticket agent.

A copy of "America's Winter Resorts," will be sent free, on receipt of a two-cent stamp by George H. Daniels, General Passenger Agent, New York Central & Hudson River Railroad, Grand Central Station, New York.

A SUMMER PARADISE

**GRAND
TRUNK
RAILWAY
SYSTEM**



HIGHLANDS OF ONTARIO

1000 FEET ABOVE SEA LEVEL.
**MOST CHARMING SUMMER
 RESORTS IN AMERICA.**
 INCLUDING
**MUSKOKA LAKES
 LAKE OF BAYS
 MAGNETAWAN RIVER
 30,000 ISLANDS OF GEORGIAN
 BAY
 KAWARTHA LAKES
 LAKES SIMCOE
 AND COUCHICHING
 LAKE NIPISSING
 AND FRENCH RIVER**

EASY OF ACCESS. PERFECT IMMUNITY FROM MALARIA.
 GOOD HOTEL ACCOMMODATIONS.
 RATES TO SUIT ALL POCKETS.

THE "ROYAL MUSKOKA"
 FINEST SUMMER HOTEL IN CANADA.

FREE ILLUSTRATED PUBLICATIONS

CAN BE HAD FROM GRAND TRUNK RAILWAY
SYSTEM. ADDRESS NEAREST OFFICE.

Boston, Mass.	T. Wyden	346 Washington Street
Houston, N. Y.	Chas. E. Coon	505 Main St. (Riffler's Store Bldg.)
Chicago, Ill.	G. W. Vane	181 Mar. House Loan and Trust Bldg.
DETROIT, Mich.	J. H. Beagle	210 Clark St. cor. Jackson Boulevard
Los Angeles, Cal.	Geo. W. Walcott	124 Woodward Avenue
MONTREAL, QUES.	W. H. Duben	271 Wilton Building
New York, N. Y.	J. Quinlan	Business Directory Building
San Francisco, Cal.	W. H. Clancy	127 St. James Street
St. Paul, Minn.	F. F. Dwyer	Post Building, 290 Broadway
Toronto, Ont.	W. O. Johnson	17 Front Street
	David Brown, Jr.	111 East West Avenue
	J. D. McDonald	Calum Building
	J. W. Ryder	X. W. cor. King and Yonge streets

OR TO G. T. BELL,
 GENERAL PASSENGER AND TICKET AGENT,
 MONTREAL, CANADA.

MENTION THIS MAGAZINE.

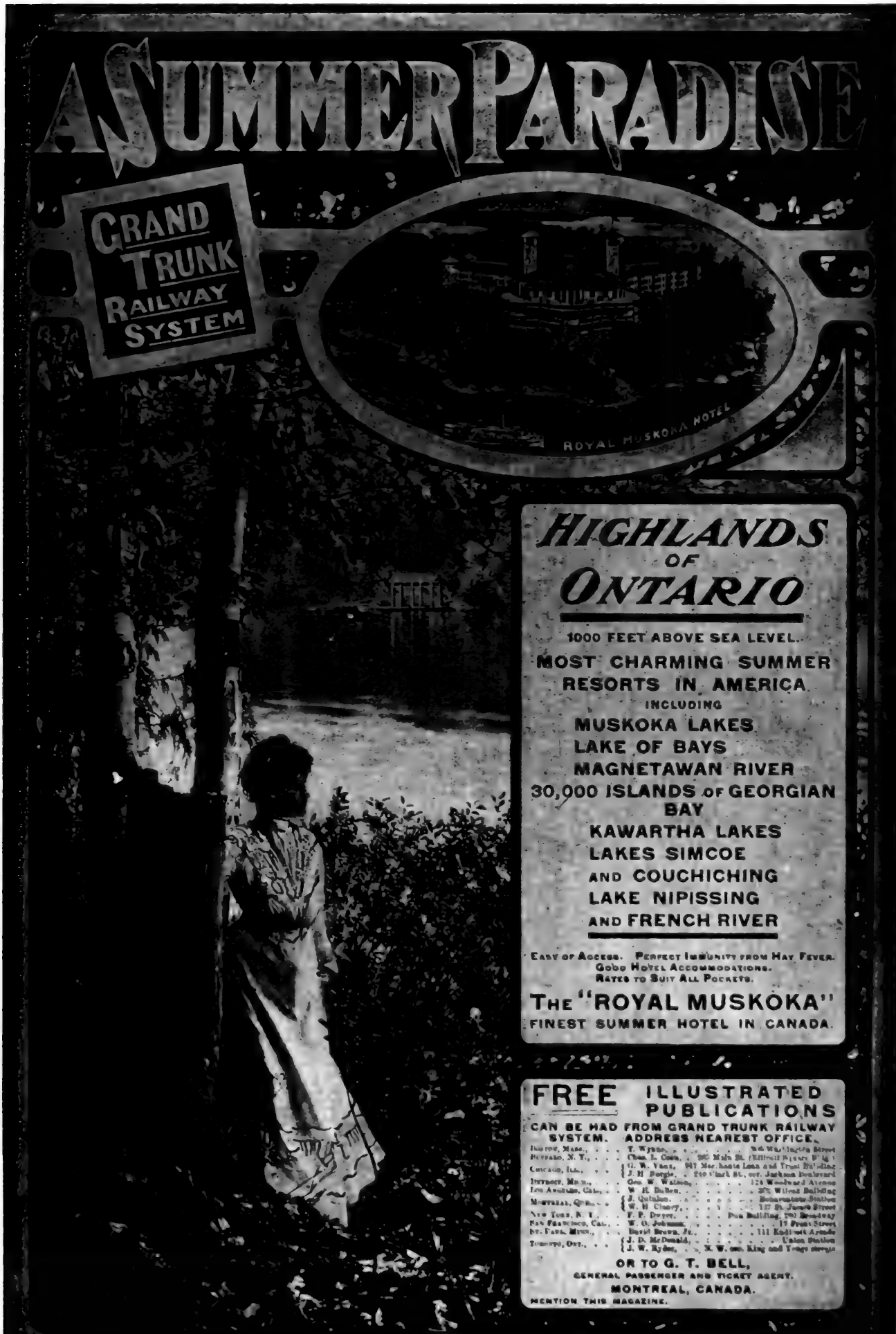

Have You Read
Betty Zane?

**Read what the
 Brooklyn Daily
 Eagle says of it:**

"One welcomes most cordially the appearance of a frontier story which is told without melodramatic exaggeration, without tiresome prolixity, and with a just and well poised admixture of history and romance. Such a story is 'Betty Zane,' by P. Zane Grey, and for once one must suppose here is a good story which has not gone the round of the publishers. Excellently printed and tastefully decorated by the author as it is, 'Betty Zane' might well have formed the piece of resistance of a big firm's Christmas list, for it is certainly as good an historical romance of the sort boys love as has appeared in a year. It is exciting, it is well told and it is good history. The author is a descendant of the Zane family, he has family documents and legends to draw on, and we hope, as he hints he will 'come again,' with the final adventures of Wetzel."

If not, there is in store for you one of the greatest literary treats of your life

=====
 The book
 sells at
\$1.50
 a copy
 =====

In ordering please mention **RECREATION**

Published by the
Charles Francis Press

30 West Thirteenth Street

New York City



McILHENNY'S
Tabasco



Sauce

Imparts Delicious Flavor

Insures Good Digestion

The Perfect Seasoning for Soups, Salads, Oysters, Clams, Fish, Sauces, Roasts, Gravies, Etc.

Indispensable for the table and in kitchen. Purer and more healthful than ground pepper.

THE ORIGINAL McILHENNY'S TABASCO

Used in leading Hotels, Clubs and Restaurants half a century. AT ALL DEALERS.

FREE—Write for "Tabasco Book"—new and unique recipes.

McILHENNY'S TABASCO, New Iberia, La.

HIGGINS & SEITER

Fine
China

Rich Cut
Glass



"Napoleon"

Cut Glass Decanter, 12½ inches high, 5½ inches diameter, quart size. \$7.50 each

If you would like to be thoroughly well informed as to

CHINA and GLASS

with a view to obtaining it from the largest collection in the world, at
"¼ Less than Elsewhere"

send for our Catalogue 14U, carrying more than a thousand illustrations. "Serving a Dinner," an elegant brochure by "Oscar," of the Waldorf-Astoria, also sent free to those really interested.

West 21st and West 22d Streets
Near Sixth Avenue NEW YORK CITY

"Buy China and Glass Right"

"FOR 36 YEARS A STANDARD PIANO."

THE WING PIANO

YOU NEED THIS BOOK IF YOU INTEND TO BUY A PIANO. A book—not a catalogue—that gives you all the information possessed by experts. It makes the selection of a piano easy. If read carefully, it will make you a judge of tone, action, workmanship and finish; will tell you how to know good from bad. It describes the materials used; gives pictures of all the different parts, and tells how they should be made and put together. It is the only book of its kind ever published. It contains 116 large pages and is named **The Book of Complete Information about Pianos**. We send it free to anyone wishing to buy a piano. Write for it.

SAVE FROM \$100 TO \$200 We make the WING PIANO and sell it ourselves. It goes direct from our factory to your home. We do not employ any agents or salesmen. When you buy the WING PIANO you pay the actual cost of construction and our small wholesale profit. This profit is small because we sell thousands of pianos yearly. Most retail stores sell no more than twelve to twenty pianos yearly, and must charge from \$100 to \$200 profit on each. They can't help it.

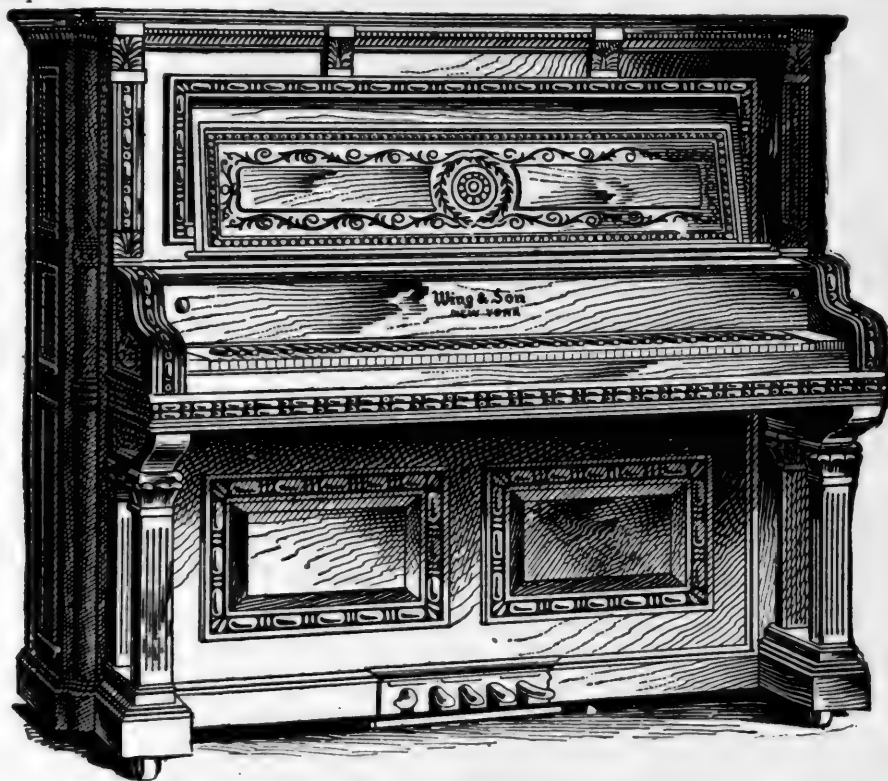

A Wing style—45 other styles to select from.

SENT ON TRIAL WE PAY FREIGHT. NO MONEY IN ADVANCE. We will send any WING PIANO to any part of the United States on trial. We pay freight in advance, and do not ask for any advance payment or deposit. If the piano is not satisfactory *after twenty days' trial in your home, we take it back entirely at our expense.* You pay us nothing unless you keep the piano. There is absolutely no risk or expense to you.

Old instruments taken in exchange. **EASY MONTHLY PAYMENTS.**

INSTRUMENTAL ATTACHMENT A special feature of the Wing Piano; it imitates perfectly the tones of the mandolin, guitar, harp, zither and banjo.

IN 34 YEARS, 33,000 PIANOS We refer to over 33,000 satisfied purchasers in every part of the United States. WING PIANOS are guaranteed for twelve years against any defect in tone, action, workmanship or material.

WING ORGANS Are just as carefully made as Wing Pianos. They have a sweet, powerful, lasting tone, easy action, very handsome appearance, need no tuning. Wing Organs are sold direct from the factory, sent on trial; are sold on easy monthly payments. For catalogue and prices write to

WING & SON. 350 to 356 West 13th St.,
NEW YORK.

1868 —36th Year—1904.



When Your Dog Won't Eat

Didn't know a dog could have chronic dyspepsia? Just let a case of disordered digestion run on unattended to, and you'll see a dog with chronic dyspepsia.

Sergeant's Condition Pills

will improve the appetite, because whatever the cause may be, these pills will seek it out at once—hit the nail right on the head—and set things right; tone up all the dog—give him vim and vigor. At all Druggists and Sporting Goods Dealers. Two sizes.

50c. and \$1.00

Sergeant's Sure Shot

The dog's lack of appetite may come from a very common dog ailment—WORMS.

Sergeant's Sure Shot will rid a dog or puppy of worms with never-failing promptness, and contain absolutely nothing that can injure any dog.

Price, 50c. per Bottle

If you can't get Sergeant's Dog Remedies, we will send them to you, post-paid, on receipt of the price.

POLK MILLER DRUG CO., Richmond, Va.

*3 cents and your address will bring you our
handsome Dog Book and pedigree blanks—FREE*

UNCLE SAM SAYS IT'S ALL RIGHT.

Uncle Sam in the person of Ten Government Officials, has charge of every department of our distillery. During the entire process of distillation, after the whiskey is stored in barrels in our warehouses, during the seven years it remains there, from the very grain we buy to the whiskey you get, Uncle Sam is constantly on the watch to see that everything is all right. We dare not take a gallon of our own whiskey out of our own warehouse unless he says it's all right. And when he does say so, that whiskey goes direct to you, with all its original richness and flavor, carrying a **UNITED STATES REGISTERED DISTILLER'S GUARANTEE** of **PURITY** and **AGE**, and saving the dealers' big profits. That's why **HAYNER WHISKEY** is the best for medicinal purposes. That's why it is preferred for other uses. That's why we have half a million satisfied customers. That's why **YOU** should try it. Your money back if you're not satisfied.

HAYNER WHISKEY

1 QUART \$1.00

4 QUARTS \$3.20

WE PAY EXPRESS CHARGES IN EITHER CASE.

Send us **\$1.00** for **ONE QUART** or **\$3.20** for **FOUR QUARTS** of **HAYNER SEVEN-YEAR-OLD RYE**, and we will pay the express charges. We ship in a plain, sealed package; no marks to even suggest contents. If you don't find it all right and better than you can buy from anybody else for double the money, ship it back to us at our expense and your money will be promptly refunded. We ship one quart on your first or trial order only. All subsequent orders must be for at least 4 quarts at 80 cents a quart. The packing and express charges are almost as much on one quart as on four and even at \$1.00 for one quart we lose money, but we want you to try it. **WE PREFER TO HAVE YOU ORDER FOUR QUARTS FOR \$3.20 RIGHT NOW FOR THEN WE WILL MAKE A LITTLE PROFIT AND YOU WILL ALSO SAVE MONEY.**

Trial orders for Ariz., Cal., Col., Idaho, Mont., Nev., N. Mex., Ore., Utah., Wash., or Wyo., must be 1 Quart for \$1.25 by **EXPRESS PREPAID**. Subsequent orders on the basis of 4 QUARTS for \$4.00 by **EXPRESS PREPAID** or 20 Quarts for \$16.00 by **FREIGHT PREPAID**.

Remit by Check, Bank Draft, Express or Money Order. It is unsafe to send currency unless you register your letter. Write our nearest office and do **IT NOW**.

ESTABLISHED
1866.

THE HAYNER DISTILLING COMPANY,

**DISTILLERY
TROY, OHIO.**

DAYTON, OHIO.

ST. LOUIS, MO.,

ST. PAUL, MINN.,

ATLANTA, GA.,







THE OTHER 2 MEN PUSHED ON WITH 4 DOGS.



RECREATION.

Volume XX.

MARCH, 1904

Number 3

G. O. SHIELDS (COQUINA), Editor and Manager

A TALE OF ALASKAN HARDSHIPS.

W. J.

J. A. Ritchie, of Montreal, D. A. McPhee, of Winnipeg, Roy Moffatt, of Pembroke, Ontario, Philip Billneau, of Duluth, and Alec Holmes, of Fresno, California, found themselves at the headwaters of the Porcupine river in the season of 1898, too late to attempt its descent by boat. With no other guide than one of Ogilvie's charts, they started, some time after winter had set in, to make a Southward cross-country trip of about 200 miles, to reach the Yukon.

Holmes froze both feet at the outset, though not seriously. Believing himself unequal to the long trip, he decided to turn back and trust to getting enough salmon at a previously found hole in the ice to keep off starvation until help should come. Holmes and Billneau were partners, independent of the other 3 men, but the 2 parties had joined for the trip up the Porcupine and overland. Moffatt and Billneau decided to remain with Holmes, Moffatt being the best hunter of the party, while Ritchie and McPhee continued the journey as already planned. They were to return with help as soon as it could be secured.

Holmes, Moffatt and Billneau went into camp at Fish branch on the upper Porcupine. Holmes fished while Moffatt and Billneau hunted. They had 7 dogs; the other 2 men pushed on with 4. All the party were poorly provided with clothing for cold weather, but they were stout young fellows, 25 to 35 years old.

Ritchie and McPhee left the others October 31. They crossed the 3 lakes

at the head of the Porcupine, crossed a mountain range, with snow 2 feet deep, traversed a wide, uneven valley drained by 3 tributaries of the Ogilvie river, crossed another low range, and found themselves on the head of the left fork of Big Sheep creek, which pours into the Yukon a few miles below 70-mile river, and 130 miles below Dawson. They reached a cabin at the mouth of Big Sheep a few days later, having been 10 days on the trip, about half of that time without food except some beaver hides. They had lost one dog and were on the point of killing one of the survivors for food. They had seen some game on the way, but were unable to get any.

The young men found good friends at the cabin. It was occupied by 4 old timers: Al and Lee Pate, George Stiller and Julius Sternberg. These men at once volunteered to return and help the others of the party out of their predicament. McPhee had an incipient attack of scurvy and a frost-bitten toe. Ritchie, who, despite the hardships he had undergone, was in good shape to travel again, acted as guide for the rescue party, his companions being Lee Pate and Julius Sternberg. With several extra pairs of snow shoes they set forth November 13, with 30 days' food supply. As the young men had come through in 10 days, the relief party expected to make the round trip in a month.

Over 6 weeks passed and no word was heard from them. The people of 70-mile began to talk of sending after them. Finally, December 19, they re-

turned, exhausted, having been 6 days practically without food. Unfortunately they had not found the men whom they had gone to relieve. They had found the camp at the salmon hole, near Fish branch, and a note left by Moffatt, saying his party had been unable to replenish their supply of game or fish, and, fearing assistance might be delayed in reaching them, had decided to attempt the return trip to La Pierre house, 200 miles down the Porcupine.

La Pierre house is an abandoned trading post, but a few Indians usually winter in that vicinity, and from them the men might get help. Otherwise, they might be able to make the portage to Fort McPherson, 80 miles farther, where some of the party had a large stock of provisions cached. Though the note did not so state, it was evident that Holmes was able to travel, doubtless with some aid from the dogs.

"It is to be regretted," said Mr. Pate, "that they did not come on our way, instead of turning back. Had they done so, they would have met us half way and both parties would have probably been saved considerable hardship. However, they knew their way back over the trail they had come and were ignorant of the country this way. They had no means of knowing if their partners had reached the Yukon."

The members of the relief party were reluctant to go into details of their experiences; they had no desire to pose as heroes and made light of their hardships, remarking that they had discovered the needlessness of carrying provisions on an Alaskan winter trip.

"You don't feel hungry after the second or third day," said Pate, "though you do feel yourself getting weaker all the time. A little tea and tobacco we had helped out wonderfully. The worst feature about going without food is that it makes you more susceptible to cold. We were unable to sleep the last 2 nights; had

to stay up and keep a roaring fire going. Yes, of course, we had the dogs, and had we not known that we should probably hold out, one or 2 of the animals might have gone the way of all flesh."

That the men had gone without food almost too long was made plain when they attempted to eat. Sternberg fainted outright and considerable effort was required to bring him around. The others experienced more or less nausea, vertigo, etc., but with a little caution were soon able to eat heartily. On the trip they had had but one chance at game. A moose was seen, and Sternberg, a man of considerable reputation as a hunter, attempted to secure the animal but failed. Sleds and snow shoes were in bad shape. The snow shoe lacings and all spare bits of hide, even to the dog whip, had been fed to the dogs on the return trip.

Narrating his experience, Ritchie said: "We left Edmonton early in September, 1897, having been induced to try that route largely by the advertising of Edmonton merchants and by an article written by A. A. Hemming, of Hamilton, Ont., who had never made the trip. Hemming called it the "poor man's route." We found it anything but that. It is not only an intolerably roundabout way of getting into the country, but is extremely expensive and difficult.

"Our party wintered on the Mackenzie below Great Slave lake. We pushed on to Peel river in the spring. At Granite Rapids a pistol costs \$50. At Smith's Rapids it cost \$15 to \$100 to have a boat taken through. At Fort McPherson, on Peel river, we had to take the 80 mile portage to Porcupine waters. There Indians are indispensable if you wish to get an outfit over; the packing charge is \$7 a hundredweight.

"It was July before McPhee, Moffatt and I finally arrived on the Porcupine, with but a few hundred pounds of food. We were joined by Holmes

and Billneau, who, like ourselves, had decided to try the extreme headwaters. We prospected all summer, but found no gold; I believe there is no pay dirt on the headwaters of the Porcupine. During the summer there was plenty of game and we got along well. It was not until both flour and tobacco had given out that things began to look blue; yet we were making good progress toward the Yukon, and all would have got out of the country had not Holmes frozen his feet."

Mr. Ritchie told in detail the story of the trip out by McPhee and himself; that their food gave out in 4 or 5 days; that they were threatened by a band of wolves, which were finally driven off; that bad luck followed 2 efforts to shoot game they saw, and that they were finally reduced to the necessity

of eating in succession 5 beaver hides.

"How did we manage to eat them? Oh, we singed off all the hair, then toasted pieces of the hide to a crisp and chewed."

Both McPhee and Ritchie had little doubt that Moffatt, Billneau and Holmes were able to reach La Pierre house, though it was a long, hard trip to make inside the Arctic circle, in midwinter, on short rations.

It was not the case, however. The 3 men were never again seen alive. The next summer Indians found 2 skeletons on the Porcupine, 80 miles from Belle river, and showed them to the N. W. mounted police. The bones were supposed to be those of 2 of the missing men. Where the third one met his death is unknown.



AMATEUR PHOTO BY C. C. SPEIGHT.

SCREECH OWL.

One of the 20th Prize Winners in RECREATION'S 7th Annual Photo Competition.

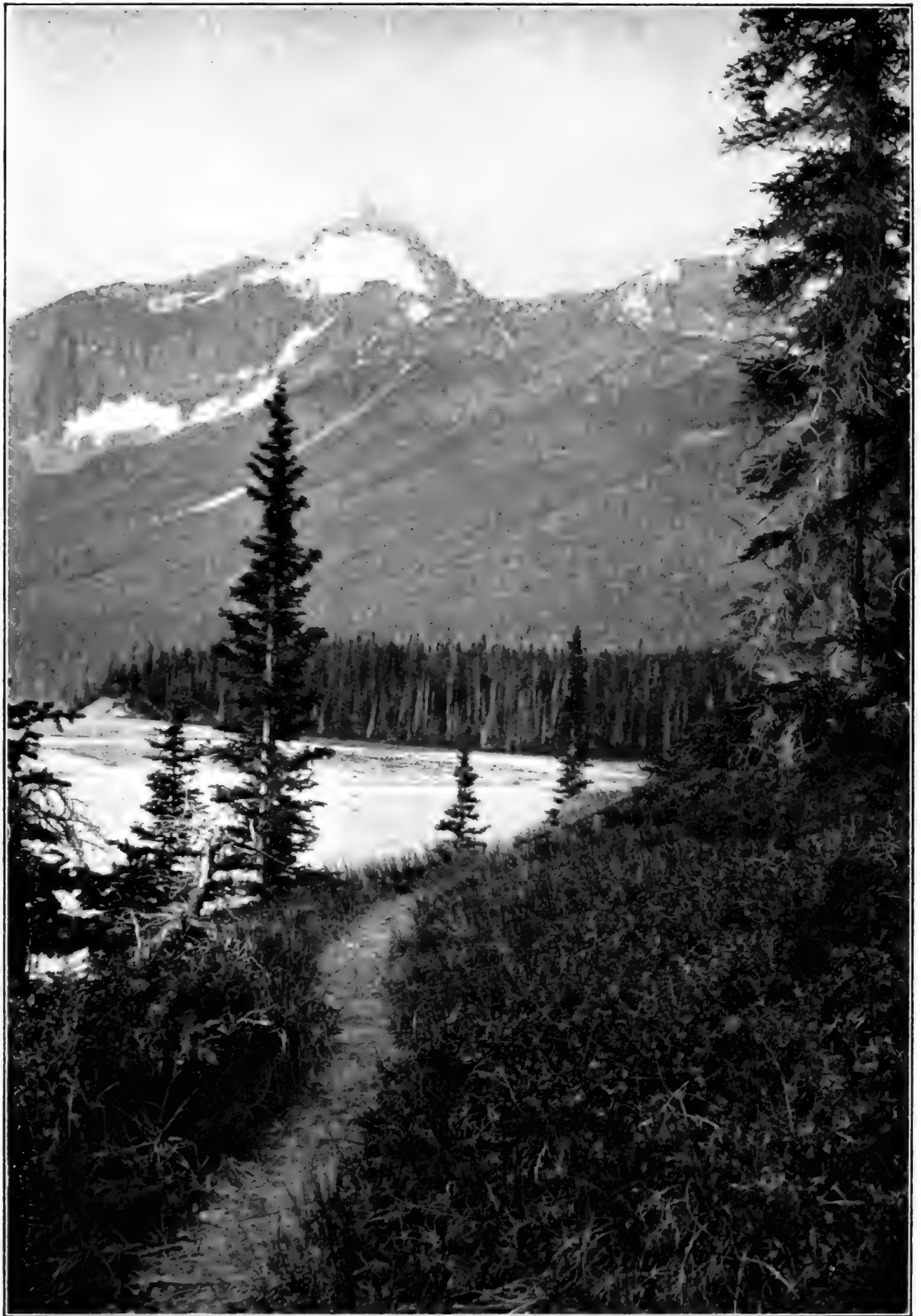

A MOUNTAIN GOAT TRAIL.

WHERE THE WHITE GOATS GET THEIR SALT.

G. O. SHIELDS.

Photos by the Author.

There is in the Canadian Rockies one of the greatest goat licks to be found anywhere. It appears to have been used hundreds of years, and in that time many tons of earth have been eaten and carried away by these strange animals. The formation is a light, chalky clay, and appears to contain a large percentage of some form of salt that the animals require in the summer, when eating young grass or other plants.

This clay was deposited by the river ages ago, when it was a much larger stream than now, and when the normal stage of water was probably 20 or 30 feet above where it is at the present day. The bank has an average height of 30 or 40 feet above the present water line and is about 200 feet long. It is covered with spruce and pine trees, some of which are a foot in diameter, and among them is a heavy growth of grass and weeds.

There are trails leading into the lick from the surrounding mountains, which average a foot to 2 feet in width, and which are in places worn a foot deep in the hard earth.

As we traveled up the river on which this lick is situated, we saw goat tracks anywhere from a week to a month old, 20, 30 and even 40 miles away, all headed up stream. These indicated that the goats were making their spring migrations to their Saratoga, so to speak. It is not unreasonable to suppose that goats living 100 miles distant gather about this lick and spend the summer there, ranging back each day 5 to 10 miles to get their food. Their trails can be followed 4 or 5 miles back before the animals seem to scatter out to feed. One of these trails leads up the river about a mile, to where a big drift has formed, which extends entirely across the stream. Trees of all sizes have jammed in there and piled up, one on another, forming a complete bridge across the stream, and the goats walk these foot logs night and morning, as they go to and from their salt feast.

We were seriously in need of fresh meat when we arrived at our camp near the lick, and Wright went up there to get a young goat. There was nothing doing at the lick at that time, so he followed the trail up the river, crossed the drift on the same logs the goats used, picked up the trail on the opposite side and followed it up a mountain 2 or 3 miles away. There the animals habitually scattered out and roamed in search of the food they needed to carry on their business.

Wright climbed to an altitude of about 1,200 feet above the river, when he landed on a sharp ridge, and looking up, saw a band of 22 goats, old, young and middle aged, big, little and middle sized. He slipped up to them, picked out a goat that would make a few square meals for us, killed him and brought him to camp. Wright said he could have loaded the pack train in 5 minutes if he had been disposed to use his opportunity.

At the first shot, some of the goats trotted away, but most of them stayed about, or walked toward him and tried to find out if the thing was still loaded. He was within 40 feet of some of the big old Billies, but had meat enough for present purposes, so did not disturb them. Unfortunately, he did not take his camera with him that day.

The goats have eaten into the side of the hill in places, so far that the roots of the trees hang down over the excavation. The eager and hungry animals keep on digging and eating clay until now and then a large chunk of the overhanging bank falls on them, crumbles and tumbles down into the river. They have loosened some large rocks which have rolled down part way. Many standing trees and several old logs that had lain on this hill for years have been undermined and have slid down into the river.

The cupidity of these poor brutes has proved the destruction of most of them. The time has evidently been when thousands of goats used the lick, where but a few, perhaps 100, use it now. All about there on the river banks are remains of old Indian camps, and in each of these is a veritable bone yard. The Indians have evidently made a practice of going there every summer, for perhaps 100 years past, killing goats and drying the meat for winter use; yet the poor brutes crave the salt so eagerly that they keep on going back every summer to get more, just as an old toper will keep going back to a saloon for more whiskey, even though he may have been kicked out of it a dozen times.

There are unprincipled pot hunters who go to these licks now, and kill 10 or 20 goats, where each man should be satisfied with one. It requires no hunting whatever. If a man is too lazy to climb the hills, he can simply sit down anywhere within rifle range of the cut bank an hour before sunset, or at daybreak, and pot his goats when they come in to get their supper or breakfast of salt mud.



A GOAT LICK.

There are several other goat licks or sheep licks in the Canadian Rockies, but none I have heard of are so large, nor have any been used to such an extent as this

one has. The Canadian Government should enact a law prohibiting the killing of any goat or sheep, elk or deer within 2 miles of any salt lick.

THE SAGE GROUSE.

CHARLES S. MOODY.

My first acquaintance with the sage grouse, *Centrocercus urophasianus*, was in the early spring of '83, when on a visit to the Big Bend of the Columbia. In my youthful verdancy I mistook these birds for turkeys strayed from some farmhouse. Where the farmhouse was, I had not paused to ask myself. In all that immense plateau there was only one human habitation. Wild Goose Bill, a squaw man, held dominion over the whole country, a region that is now one great wheat field. The grouse were sitting beneath the sage brush lining the dim wagon trail, and with my new Fox gun I slew one, congratulating myself that we should have fresh meat for supper. We had it, but somehow we did not enjoy it as I had expected. They say it is all right when you get used to it, but it takes anybody except a Siwash a long time to get used to it.

When the spring sun has brought new life to the sleeping vegetation, Mr. Sage Grouse dons his courting garments, tunes his lyre, and goes forth to seek a mate. He usually finds one, for it has been my observation that the softer sex are within hailing distance whenever there is any wooing on hand. Having made his advances and been accepted, the twain repair to some elevated spot, bare of vegetation, that, during the nesting season, is used as a trysting place. There, at early morning, and late evening, the ardent swain, with wings spread, tail and head erect, struts to and fro before his demure dame, all the while giving vent to a series of gutturals that may be particularly fetching to the object of his amours, but are anything but harmony judged by human standards. How long this performance is continued I am unable to say; probably, however, throughout the laying time and until the mother bird takes up the task of incubation.

The nesting site is some swale grown with rye grass, or some hillside underneath a large sage. There are laid 8 to 10 beautiful, dark brown eggs, deeply mottled and streaked with black. The nest is a mere depression in the light, alkali soil. The

period of incubation corresponds to that of the other *Gallina*, that is, about 21 days. When the little downy, cream colored chicks first make their appearance they resemble those of the domestic hen; and like the hen, the mother bird is extremely solicitous for their welfare. So intrepid is she in their defense that she has been known to beat off a great barred owl which was seeking a young grouse for dinner.

It has been suggested, owing to the fact that these birds inhabit the dry, arid plains of our Northwest, that they do not drink. Such is not the case. When the country was new and unsettled, at evening the hunter could see thousands of them winging their way to some distant spring. Visit the springs, of which there were a few, and the noise of the wings was as distant thunder, as the birds rose in myriads.

Late in the fall, after the winter winds have begun to blow, the male bird who has spent the summer with some of his cronies boasting about the size and excellency of his brood, a habit he probably learned from some human fathers I know, rejoins his flock. Together they seek a sheltered valley, where their winter food of sage grows, and there pass the cold months. It is the sage that gives them a taste like concentrated sausage seasoning.

The sage grouse is an unwary bird. It can be approached within a few rods. These birds possess a curiosity akin to that of the antelope, which impels them to investigate anything new. Once on the wing, however, their flight is graceful and swift, much like that of an English pheasant. When a sage grouse starts for the next county it takes a good marksman to bring him down. I deeply regret that pot hunters have been permitted to slaughter this magnificent bird, so little fit for the table yet so picturesque a figure in the landscape. In a few more years the lover of Nature will be compelled to visit some museum of natural history or some zoological garden for a sight of the birds that were once doorway visitors at every ranch on the Western plains.



AMATEUR PHOTO BY G. W. WOOD.

SAVED, BY GUM!

Winner of 9th Prize in RECREATION'S 8th Annual Photo Competition.
Made with Bausch & Lomb Lens



AMATEUR PHOTO BY R. H. BEEBE.

THREE BLACK CROWS SAT ON A TREE.

Winner of 10th Prize in RECREATION'S 8th Annual Photo Competition. Made with Goerz Lens.

BEARS AND THINGS.

FRANK MOSSMAN.

A black bear will eat anything, from a honey bee to a well greased sawmill. He is an epicure on honey. He will knock over a hive and fight off bees with one hand while he helps himself to tenderloin honey steaks with the other.

He is also fond of pork. He will gather a hog in his arms as mamma does her baby, and cuff it into silence if it yells. When he has reached timber with it, he will sit on his haunches and cuff it till Porkie is converted into chops, spare ribs, sausages and other convenient delicacies.

I remember some fun I once had with a bear which was trying to carry off my winter's supply of spareribs. I had danced all night at a country hop and on my return at daybreak to my palatial residence, half wickyup, half cyclone remains, I found Bruin at his work. I had neither a gun nor son of a gun, so grabbing the first thing within reach, a pitchfork, I went after him and poked him in the dining car. I was handicapped by my swallowtail coat, though it eventually proved useful.

The bear paid no heed to me till I poked him; then he turned on me. We both sparred cautiously for an opening. Thinking he had caught one the bear made a swipe at me, and caught me on the hash machine. Feeling that I could fight freer in my working clothes, I started to the house for them. The bear removed all those little difficulties, and my clothes. Five to one on Bruin and no takers, when 2 young ladies happened along. The sight of a bear chasing a wild eyed man, whose only raiment was a pair of poorly matched side whiskers was too much for their nerves, and they unbuckled a few yells, which caused my pursuer to break for the timber. I did likewise, having always been noted for modesty when my wardrobe was not handy.

My clawhammer coat undoubtedly saved my life. When the fight was the hottest the tails of that garment displayed almost human intelligence. I could see better fighting grounds on a tree a mile away and started for it. That's where the coat tails got in their work. They flapped up and down so fast in the bear's face that he could see nothing but coat tails and the dust I kicked up. I finally reached the tree but the bear had lost hope of lunging on me and dropped out of the race.

On one occasion my dog ran a bear into a big hollow cedar. Coming up, I sent one of my dogs into the hole at the ground.

As he did not get hurt I went in. Peering up into the darkness above me and seeing nothing, hearing no sound, I concluded the dog had been fooled.

Just then something slipped, and it wasn't the bark. It was the bear. I made for the hole; so did the bear. The fellow was so delighted at the meeting that he took me in his arms and folded me to his bosom. He hugged me so close, and withal was so awkward with his claws, that for a moment I contemplated sending for a suit of clothes. At last, through a slight inadvertence on the bear's part I got out and with a lucky shot laid him low.

I was so changed in appearance that my dogs didn't know me at first. I was a second Rip Van Winkle, as far as clothes and ribs were concerned. If you wish to know how the tail end of a cyclone feels just get fast in the hollow of a tree in company with a healthy bear and 4 or 5 dogs.

In my youthful days it was my dearest ambition to own a menagerie. The great lack was for material. One fortunate day I chanced on 2 bear cubs, gathered them in my arms and started joyfully homeward. Unluckily the old lady bear came on the scene and asked to be included in the collection. As my project did not embrace a 3 ring attachment I dropped the cubs, also the menagerie scheme, and fled for life, making more noise and tracks than 2 menageries. I reached my long legs in front of me, pulled the distance under me, and kicked it out behind, like a streak of small boys 100 yards long.

I once set a trap for a bear: several traps, in fact. A stout pen was made in the timber and a hog put in. This bait was fed once in 2 days, and the way he yelled for rations was a caution. The bear heard the rumpus, came up to pay the hog a visit, and began by taking a walk around the pen. In that way he put his foot in it, a No. 5 Newhouse. There was another trap, but the bear seemed satisfied; didn't care to look up any more; so he tarried there till I went out and called on him socially.

Late in the fall the bears here fill up on salmon, then crawl into a hole and pull it in after them. I found a bear hole once, and crawled in. The bear had hired a family of skunks to 'tend door. As I had no ticket they refused me admittance, but generously presented me a bouquet. I retired. I may get old and gray, but the scent of that bouquet will linger in my whiskers forever.



THE FOX, STRAINING EVERY MUSCLE, FLEW OVER THE WHITE SOFTNESS.

AN EYE FOR AN EYE.

MELEAGRO.

It was a clear cold night late in January. A full moon, shining on the fields of snow, unbroken save by patches of evergreen and maple forest, made the night almost as light as day. A hardly perceptible wind drifted from the North, causing the tall tree tops to sway lazily to the accompaniment of a gentle moaning. In a hollow among some young hemlocks, with the large, dark woods on both sides, sat a rabbit, attentively lis-



ATTENTIVELY LISTENING.

tening to something moving in the depths of the gloomy forest. The spot was a natural enclosure. Beyond its hemlock wall everything was in another world, for all that human senses could detect. The rabbit, however, was greatly interested in something there in the woods, and signified his curiosity by his fixed position. Sitting on his haunches with his ears inclined slightly forward, he looked much like the stump near which he was stationed. He remained thus several minutes, and then quietly resumed his feeding, digging holes in the snow wherever his nose told him there lay some delicate morsel. Still he

seemed ever on his guard, keeping one ear in a listening attitude.

On the other side of the border of evergreens, in the dark woods, crouched a larger form. It lay at full length on the snow, its whole attitude showing intense excitement. Slowly and with utmost precaution it glided forward. So steady were its movements that they were almost imperceptible. It raised one dark fore foot, placed it before the other, keeping its head pointed in the same direction and its tail and back on a level. It was a fox, with a dinner in sight, or, more correctly, in scent. Never did animal take more pains, and never was there a more beautiful creature than this fox, stalking his dinner; every line of his body a natural curve, and the whole the emblem of crafty grace. Slowly he approached the border of the moonlit glade. Carefully he placed his feet, that they might make no sound; for the slightest misstep would mean the loss of his dinner, and he was hungry. A low murmuring arose from the forest, a gentle swaying of the tree tops, although below, where fed the rabbit, all alert, but still unconscious, and where crouched the fox, all eagerness, not a breath stirred. From the distance the long, faint howl of a fox hound restrained in his kennel and anxious for the hunt, came drifting. The fox heard, and the hair above his shoulder blades rose slightly, but otherwise he cared not. He was at the edge of the open, his nose moving restlessly and glistening in its moisture, beyond the protection of the guarding hemlock boughs. A few feet distant sat the rabbit and the sight of that delicious morsel made the fox's eyes glitter more savagely. Slowly he crept from out his covering, and crouched for the spring. An owl in the distance uttered its quavering whistle, the rabbit sat up to listen. There was a quick rustling near the hemlocks, and a great, furry object hurled itself at the surprised rabbit, which quickly turned and fled. The snow was deep and the rabbit was thus handicapped; while the fox, a personification of feathery swiftness, straining every muscle, flew over the white softness and came up with the pursued. There was a scream, a snarl, a significant crunching and then all was quiet, while from the distance came again the owl's querulous moan.

Then, without a sound the fox stalked back to the edge of the woods, something hanging from his jaws. As the howl of the restless hound came again to his ears, he

stopped to listen, and then as silently as he had come, he disappeared in the friendly forest.

Slowly the moon crept across the heavens until it neared the Western horizon. During all those hours not a living creature moved within the limits of that natural enclosure. The owl circled in the woods beyond but did not invade the loneliness of that spot. The shadows of the young hemlocks lengthened until they were covered by the darker shadows of the main woods, which in turn threw the whole place into deep and obscure darkness. The moon, reddening as it neared the horizon, at last sank behind the distant hills and the stars again came forth in their splendor. Silence reigned supreme. The fitful breeze had died, the stiff hemlocks stood like sentinels, tireless watchers of the varying phases of nature. The coldness increased until the frost made the woods resound with the occasional crack of one of its monarchs.

The stars in the East began to disappear, one by one, until only the morning star was left. This grew dimmer as the grey light of dawn became stronger, until it, too, said good morning and vanished. The light increased, the deep woods threw off their gloom and once more became suited to human eyes. A beautiful, reddening glow suffused the Eastern sky, increasing in strength until it became bright yellow. Then suddenly the sun leaped over the pure, white, glistening hills, changing everything into dazzling glory. The opening in the heart of the woods was transformed with its gladsome brightness and only the tracks in the snow told of the murder that had been committed there. Squirrels and other animals of the day called through the forest, and birds, awakening from their rest, voiced their thanksgiving, while at breakfast among the seeds.

Suddenly all natural sounds of the wilderness were silenced by the long howl of a fox hound. It was repeated once and all was again quiet. Then without a sound, as if he walked on air, and as lightly as if upheld by some unseen power, a beautiful fox stepped out into the open.

His rufus coat shone like gold in the bright sunlight as he stood with one fore foot slightly raised and looked back over his shoulder, listening for the hound which had intruded on his domain. What a picture! A bright red, wild creature, every line of his body graceful, black legs, black ears, inclined sharply forward, and rufus tail tipped with white, outlined against the dazzling snow and the dark green hemlock!

Could a more beautiful object be imagined than this wild creature, dependent on his own wits for a livelihood, responsible to none, and free? If the hound were to pur-

sue him he was ready for the chase! The evening meal of rabbit had given him strength, so he cared not for the clumsy dog. He forgot the man and his gun. The fox never killed except for need; the man killed for gain and pleasure.

While thus the fox stood, the hills once more resounded with the baying of the hound and Reynard trotted silently away, to try his ingenuity on the foolish dog. He had hardly vanished into the opposite side of the woods, when the hound's tonguing took on another tone, more eager, as he struck the fresh scent and leaped ahead.

The chase was on! The fox sped away across country, running easily, but swiftly, over stone walls and rail fences as he came to the fields. Then he halted and listened to the excited baying of his pursuer. Out in the open, half a mile distant, stood the fox hunter, leaning against the bars, where he might get a shot at the unsuspecting fox; but the quarry, as if guided by an unseen guardian, after running along the top of a rail fence for several hundred feet, leaped back into the brush and sped away. On came the hound, racing along on the fresh scent until he reached the fence. Then he was at fault for several minutes, but at length regained the trail. Away he went until his loud voice became barely audible, and then was lost to hearing.

Once within an hour the hunter saw the fox race across a distant meadow, and several minutes later he saw and heard the hound pursuing. Again a long period elapsed before aught was heard of the chase, for the fox had led away and seemed willing to rely simply on his speed and endurance to escape. Several times in the afternoon the man thought he heard his dog, far to the Southward, but was not certain. At last when there were still some 2 hours of sunlight left, the hound's voice sounded faintly from the South, slowly and uncertainly growing louder. Now it was almost inaudible as the fox led him down into the valley, now distinct as he trailed along the ridges. The man heard, put out his pipe, and prepared to lay out the fox which had caused his hound so much exertion. He was angered that he had been kept out in the cold all day and had not had a chance to shoot. He was angry to think he had lost a day's wages and might have to return empty handed; but as the hound's music drifted to his ear visions of the bounty and the price of the silky fur came into his mind. Perhaps he would not go home empty handed, after all, and deep down in his hardened heart he rejoiced. He was not poor, nor did he need the money. Nevertheless, his lust for killing was intensified by his desire for gain.

The fox, unconscious of danger, was

speeding back to the deep forest whence he started. He was nearly half a mile ahead of the dog, and running easily when the hunter saw him stop to listen. On he came again after a moment's pause, straight for the bars which sheltered the man. The fox did not know that as he flew along a pair of gun barrels were leveled at his graceful form. He did not know the man behind them was only waiting until he should come in range, so he might change this beautiful creature to a mere mass of carrion. As the fox flew onward, going straight as an arrow to his death, he thought of the hound, tired and hot as he labored, and, perhaps himself a little weary,

he stopped to look around. Again he heard the hound behind and must have laughed to himself as he thought of the trouble he had made. Then, resuming his course, he leaped straight toward the gun.

He was so close that there could be no chance of missing. A streak of fire belched from the gun. The fox leapt high into the air and turning struggled away, a front and a hind leg broken. Without a sound he struggled on, pain and hate gleaming from his yellow eyes, until the second barrel put an end to his suffering and he was at peace with everything; a mass of silky redness on the pure, white snow.

THE MODERN SQUIRREL HUNTER.

JOHN L. WOODBURY.

A rustling among the branches,
By the autumn sun gold-crowned;
A patter of ripe nuts falling
In a shower on the leaf-strewn ground,

And the heart of the hunter quickens,
As his keen glance upward steals;
While his way through the tangled brush-
wood
To'rd the wary game he feels.

Like a statue amid the forest,
He waits till the feast is done;
Till the squirrel glides from his cover,
And blinks in the dazzling sun.

Down the tree he swiftly scurries,
With never a fear nor doubt,
Till he reaches a branch that suits him,
Where he stops and peers about.

And he sees not the silent hunter,
Who his piece to a ready brings;
A swift, sure aim and a pressure,
But no roar through the forest rings.

No thud of a falling body,
But only a clicking sound;
No wounded and bleeding creature
Lies gasping on the ground.

Like a flash the startled squirrel
Flies back up the tree's rough face,
Away, like a glancing sunbeam,
All unharmed in his beauty and grace.



AMATEUR PHOTO BY JNO. H. FISHER, JR.

LITTLE GREY BROTHER.

Highly Commended in RECREATION'S 8th Annual
Photo Competition.

And the hunter's heart is swelling
With a pleasure that lacks the pain
Which must ever come to the sportsman
When a woodland creature's slain.

For we read in RECREATION
Of the modern sportsman's fun
When he learns to hunt with a camera,
And cares no more for the gun.

A TALE OF THE WOODS.

CHARLES T. MURRAY.

This is the story of Francois, the guide. He told it one night when, after a day's tramp, we had encamped on the shores of a lake, deep in the heart of the wilderness. The lake was dark and gloomy, surrounded, save on the side where we had built our camp, by great forests of pine. As we lay back on our beds of hemlock, with pipes well alight and the gleam of the camp fire in our eyes, the cry of a loon, wild and quavering, came floating over the dark waters. Francois started so quickly that he spilled the lighted tobacco from his pipe, and I heard him whisper to Sam, the Indian, "I no lack dis place, me, she seem too mooch lak Devil lac."

"Tell us about Devil's lake, Francois;" I said, half dreamily; and he did, while Sam and I lay back and listened, soothed by the murmur of the wind in the trees and the lisp of the waves as they washed the pebbly beach.

"I been there once, me," began Francois, "but, Mon Dieu, no! I nevaire go thare gin; not if I been live so old as Messu Methusilum, not after all de moose or caribou or deer what live roun' dat lac. She was good many year ago dat I come on dat place, but ever tam I hear loon holler lak she did jess now, I 'member dat tam lak she was yisteday. I was young mans, me, den, not 'fraid notting 'tall—jess leve fight mans or bear as not; but when you come see Ole Nick, heesself, den you know what scare is. I was been guide dat summer for Messu Georges, heem dat's dead now. Hees die rat on shore dat lac; heart disease, de doctaire say, but, me, I know bettaire, I was been there maself an' see."

Then I remembered having heard or read of the tragic death of Georges in the heart of the woods, and how his faithful guide had carried the body miles through an almost pathless wilderness, that it might have decent burial.

"And you were with him, Francois, when he died?" I asked with some curiosity, for I had heard great things of Georges' guide.

"No, no, Messu," said Francois; "I not be right there, me, cause then I be daid too, but I hear and see, yes, I see plain-tee. Messu Georges an' me have been hunt on de woods 2, 3 week dat tam. Had plaintee game an' fish an' have nace tam. One day we come cross beeg crick, ver' black an' cole and full of trout.

"Not ver' beeg trout but jess many. I doan lak look dat brook, but when Messu

Georges, he say we folla heem up, I muss go too. Dat crick she's beeg almose lak de rivair, but Messu he tink it only leetle way to de start. So we hide our stuff on de bushes and teck de rifle an' fresh pole an' start. All dat day we tramp, tramp, an' dat stream she's get beeger an' beeger an' blacker. Den Messu he feel mooch encourage an' he say, 'Only leetle funder now,' so on we go an' jess as de sun she's goin' down, we come on dat lac. Soon as I see dat black lac, I get scare, cause I know dat's de place where de Devil, heemself live. 'Twas beeg lac, mooch gin so beeg as dis one, but de rocks an' de trees was black, also, same lak de water. On one side dat rivair we go up was sandy beach, 'bout so beeg as de canal; ever where else, great, beeg pine tree growed down on dat lac clear to de watair, an' some growed rat in de watair, lack de tree grow on de mill pon' some tam. Bymeby, when I teck look roun' an' see dese ting, I say to Messu Georges, 'I no stay here, me, I go back.'

"Non, non, mon ami," he say, 'we camp here. Muss be mooch feesh on dat lac.' So I have stay.

"I cut down some brush for meck de house, an' feex de bed, den Messu he git hungry an teck hees l'ill pole an' go down on dat lac an' trow hees fly. By gar! dat fly no more tech dat watair dan 3, 4 feesh jump for 'em. He ketch 2 at de firs' cass. Not ver' beeg fish, them. So Messu he go up de shore l'ill funder an' trow way out whare beeg rock shes stick up lak de mushrat house. He trow 3, 4 tam an' when hees mose discourage, he git big raise. Way go de line, de reel she sing, an' de feesh he jomp far out on de lac. But Messu got heem fass an' by-meby reel heem in. I git hole on hees gill an' den we have our suppaire.

"After we been eat lot, we lay down an' smoke on de pape. Ever'ting she's ver' still, only some tam we hear de loon yell lak she do to-night. De sun she's gone down an' dat lac she's so black lak de tundir cloud. Messu he smoke, smoke on de pape, den he say, quick lak. 'Francois'; an' you bet I jomp good. Messu, he laff, den he say:

"'What all foolishness 'bout dis lac?'

"I tole him 'bout Ole Joe, an' how de Devil heemself come up outen de watair an' got heem, an' I say we better move our camp back on de woods. Messu he laff more an' shack hees head. Den we set dare for long tam'. Messu he say notting

'tall, an' I say same ting, but keep look on dat black lac. Den Messu he say:

"'What dat out yender?"

"I look an' look, but doan see notting.

"I think I see canoe,' said Messu, an' mon gar! I look gin an' see someting lak canoe, but so dark can't be sure.

"'Ver' strange,' say Messu. 'Some Injun or trappair, mebbby.'

"I say notting but keep tink mooch. Den de moon she's begin come up an' dat meck me feel bettair, cause dat lac not so black. Messu he say hees tired an' we go on de bed, so we crawl in dat brush house, an' pull de branch on top ourselfe. I do'no for sure, but I tink I go sleep, 'cause me, I's ver' tired. Nex' ting I know somebody poke me on de rib an' when I wake up, Messu he set up an' pint hees fingair an' say:

"'Francois, look dare!"

"I look where he say an' way over nex' odder side dat lac, I see canoe plain, wit someting all white on it. Den de moon she's hit a cloud an' de light mose go out an' I feel Messu reach for hees rifle. I begin say prayer mighty fass, me, for what good l'ill rifle do on de Devil heemself. Den cross dat lac come one loud cry jess lak woman she's meck when she's fear mooch. I tink den Messu, hees begin get scare also lak me, cause he say:

"'For God's sack, Francois, what dat?"

"Den de moon she come out gin, an' I see dat canoe come near an' in it was a woman an' she's paddle fass, fass, an' Holy Mother! jess behine her come nudder canoe wit someting beeg an' black on it an' dat boat move fass too, an' gain on de firs' one quick. Dare was pint of lan' wit trees on heem thar, an' bimeby bote canoe he go behine dat pint. Den Messu he say:

"'Mon Dieu, Francois! Did you see what was in hine canoe?"

"I so much scare I can say notting but pray, cause I know what dat ting be. Bymeby dat bote come out in de light gin. De secon' canoe she's mooch near den, an' dat woman she turn her head roun' an' shriek

an' shriek awful, jess lak loon, an' I see Messu cover up bote hees ear. Dat ting in de secon' canoe he stan' up den an' I see heem plain, plain. Mon Dieu, I been try be good mans, me, since that day. Hees ver' beeg an' tall an' hairy lak de black bear. I hear Messu cock hees rifle an' fore I can stop heem, bang, go de gun, an' I can't see for de smoke. Wen I look gin, dat woman she's disappeare—gone up on de smoke, an' de ting in odder canoe was come at us fass, an' he doan have paddle, de boat go himself. Den he turn hees face an' look for see us—"

Here Francois paused and repeatedly crossed himself, then continued:

"Hees face was jess lak de picture of de Devil you seen on de book. Beeg black horns, nose lak de eagle and long tushes lak de wolf hound. 'Mon Dieu, Messu, run quick!' I yell, but he begin shoot 2, 3 tam. I see de bullet splash roun' de boat, but she doan stop 'tall but come rat on. Jen I jomp quick and run fass on de woods an' hide me. Bymeby, pretty soon, when I doan hear notting, I say to maself, 'Francois, you beeg coward, you dam fool. De moon she's high on de sky den an' mooch light, so I begin creep on dat house. Messu Georges hees set up straight jess lak notting happen, an' I tink firss hees gone sleep, so I crawl up soff, so not wake heem up. Den I see hees chin drop way down on hees bress; an' see beeg track on de san' leading down to dat lac from where Messu he set. Gre't, deep footprint lak de moose she meck, only, Mon Dieu days lak a man's wid beeg nail prints. I look at Messu den gin' an' I see hees eyes wide open. Hees mout drop down, an' I know hees daid. Den de scare she tek hole on me gin' an' I run fass from dat plass. Next tam I go back de sun hees way up on de sky. I took Messu on ma back an' carry heem down dat crick way from dat plass. Messu Doctaire, down on de village, who look at him say hees die by heart disease, but Francois, me, he know bettaire.

Father: "It seems to me Freddie, that everything I say to you goes in at one ear and out at the other."

Freddie: "Well, I s'pose that's what I've got 2 ears for."—Exchange.

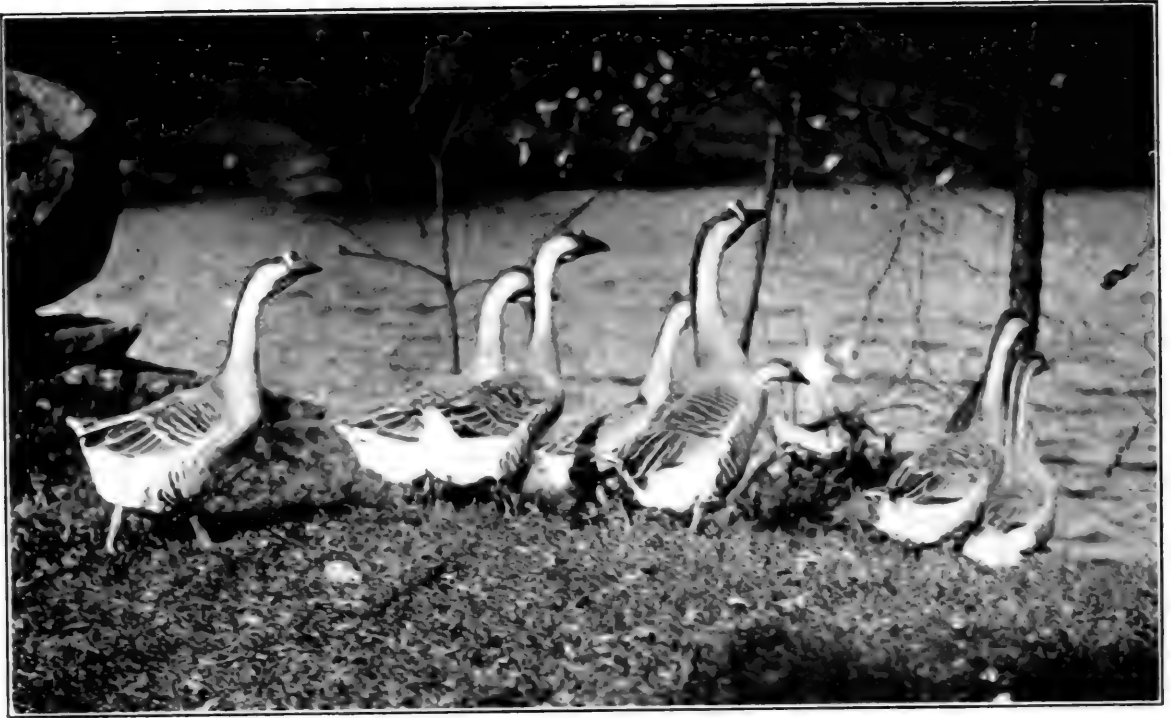

THE ARMY.



AMATEUR PHOTOS BY C. A. REED.

THE NAVY.

Winners of 12th Prize in RECREATION'S 8th Annual Photo Competition.

A FLORIDA FISHING PARTY.

E. M. LEETE.

A bright day in March, 189—, found my wife and me driving slowly through a Florida pine forest. Our outfit was queer to our Northern eyes. Our little Florida pony was hitched to the skeleton of a wagon, and a small round bottomed row boat was loaded on to the 4 wheels. We sat in this boat, my wife on a tent tightly rolled in the bow, and I in the stowsheets, driving the horse. We had with us in the boat a basket of luncheon, cooking utensils, rods, lines, an ax, bedding, and feed for our horse. We had been in the South a month and had exhausted all near resorts, when someone told us of a lake 12 miles out in the country, where bass, or trout, as they are called in Florida, were abundant. To this lake we were headed, and were then more than half way there. The sand was deep and the sun was hot. Our horse was tired, so we let him take his own gait, as time with us was of no account. We had come from mid-winter in New England, and the transition from snow and ice to summer in so short a time was a marvel which we thoroughly enjoyed. There were houses only at rare intervals, and no fences; only the trail leading through seemingly endless pine woods. We came once to a turpentine camp, and passed hundreds of pine trees gashed to get the turpentine, somewhat as maple trees are tapped in the North. We found dozens of small lakes set like jewels in the forest. In the town, where we were stopping there were 21 within the corporation limit, a tract 2 miles square, and most of them with neither inlet nor outlet. It was a long pull, but about 3 o'clock we reached the lake we were bound for.

On a point jutting out into the water, and covered with pine trees, we pitched our tent with the open end facing the lake. We cut palmetto leaves to spread our blankets on, gathered wood for a fire and made ready for the night. Then we launched our boat, to catch a fish for supper. The lake was bordered by pine forests and in places a dense growth of underbrush, the home of alligators, moccasins and water snakes. I had learned when blue fishing on Long Island sound that I could often get fish on a long line when boats using shorter ones could not get a bite, and soon found that the same rule worked in Florida. When we were half way across the first bay we had a strike and my wife hooked a fish and boated him, a trout weighing about a pound; and this was followed by others, until we had 6.

Not wishing to waste any we started back to our little tent, gleaming white against the dark green of the woods.

The sun was nearly down when we pulled the boat up on the bank and stepped out. Taking our fish, we went up to camp and started a fire. It is wonderful what a fire will do to make a spot look home-like. In the gathering darkness, before the blaze lit our camp, it did look a trifle lonesome, away out there in the pine woods, and both of us, for a moment, thought of our bed back in town. The fire made all the difference in the world, and from a lonely spot in the woods the little camp was changed into our home. After supper there was the horse to feed and water, wood to split for the night, and then it was bedtime. People who have always slept in a bed indoors have no idea of the pleasure of a night in camp. Our couch was, to be sure, laid on the ground, but it was soft and we had plenty of blankets. The fire made it as light as day and cast a grateful warmth in at the open door of our tent. Listening to the call of the night birds and the sighing of the wind in the trees, we fell asleep, to be awakened by the sun shining in on us the next morning.

It was worth much to look out on the picture spread before our eyes that morning. The mirrorlike lake, set in the green fringe of the pine trees, lay at our feet, with the light morning mist rising from the water, while in the blue arch of the sky an occasional buzzard swung in endless circles through the still air. It was a typical Florida morning. Birds were singing in the trees, the air was fresh and cool, and it was good to be alive. After breakfast we took some live bait, rowed out to what looked like a good spot, and anchored. Rigging our Bristol rods and hooking on a minnow, we made the first cast of the day. For myself, I can scarcely wait until I get my line over the first time. There is a feeling about the first cast that I never lose, even after having fished many years. The bait slowly sank in the clear water, while we both stood ready for the first fish; but he did not arrive. We moved the boat and tried again, with no better success. Not a bite could we get. Again we made a change and that time found some fish. First the Mrs. hooked a lively one, that put a beautiful curve into the little Bristol, while the slender line cut through the water in a way to delight the heart of any angler. The little lady at

the reel end of the rod, however, knew her business, and played the fish until after a short fight we put him in the boat. Then I had one and then another. The Mrs. was keeping up her end too, and together we had 16 fish when they stopped biting. Not another one could we get. Lifting the anchor and taking the oars we again put out our spoons, and keeping in 6 or 8 feet

of water we rowed clear around the lake. We took 6 fish in making the circuit. These made 21 in all, and we put back to camp, tired and hungry. A luncheon and a short rest made us all right, however, and we returned to town. We had had no record fishing, but the whole trip was a novelty and a pleasure. The fishing was an excuse for it.

CAPTAIN JOE MUFFRAU.

H. W. BRADLEY.

Wot's dat you'll hask? Wot's dat you'll say?
 Did I know Joe Muffrau? Well! a good many day.
 Ah know two Joe Muffrau. Wan of it is name Pete.
 Capitaine Joe Ah'll s'pose ees de wan you meet.
 Ware he was born Ah don't know, but respec'
 Eet was hon Canadah, down behine Quebec;
 But she's leeve hon dees State, sail de Lak' 'Uron shore,
 Lak' San Clair, Hanchor bay, down to Baltimore.

REFRAIN.

Joe Muffrau was de stronges' man
 Dat hever was leeve hon Michigan.
 W'en she's strike hon de air de bes' he can
 De win' off hees fis' would kill a man.

W'en we pass hon de lak' de win' blow from de heas'
 Bimeby she blow more, w'ip de watter laike yeas'.
 We was load wit' hooppole, tan bark an' cord h'wood.
 We try to make Swan creek de bes' wot we could.
 "T'row de h'ank!" Capitaine yell. "She's got no cabil!" Ah say.
 "T'row he hout," said Muffrau; "She'll do some good hanyway."

But she hain' do some good. We was wreck on de shore.
 We'll walk h'out h'on de bank an' pass Baltimore.
 Ah was sail hon de lak' wit hole' Capitaine Joe,
 Hon de hole' Julie Plante, wen she's wreck' down below;
 Hup to hole' Mackinac hon de hole' Julie Plante,
 Capitaine Joe take hout, w'en somebody can't.
 We sail close de shore, we strike hon san' bar;
 De night ut was dark, we han't see wan star,
 Cap Joe, he's jump hout. Am'm tell dees a fac',
 He push san' bar an' boat hout into de lak'.

Hall dose odder skipper, dey'll come to hask Joe,
 "Eas she goin' for storm?" "W'at you tink boaut she's blow."
 Cap Joe says, "Stay here, eets no use for stir,"
 Ah jus' had a look hat my bar-om-e-ter.
 Joe was maken't heemself molasses alc'hol,
 An' some more kin' of stuff 'e haint tell it hall.
 Wan day 'e was dry, hees tongue was laike fur;
 'E'll jus' drink hit hall, hees bar-om-e-ter.

Mr. Newlywed—How dare you swear before my wife?

Indignant Chauffeur—How was I to know your wife wanted to swear first?—New Yorker.

BAITING A BEAR.

WILLIAM J. LAMPTON.

"I never was much of a hunter for animals," said the retired prospector, "but I have hunted for more mines than would buy all the millionaires in America if they had panned out right; and I am here to say it is about as dangerous kind of hunting as going after tigers with popguns, unless a man knows his business mighty well. There's danger of starvation, of freezing, of drowning, of falling over precipices, of running against wild animals and wilder men. It's no bed of roses, this business of prospecting. Every prospector, who knows what's what, carries a good supply of morphine, so if he happens to break his leg somewhere beyond civilization, or runs out of chuck and can't get to a new supply, he can just swallow some dope and go to sleep for keeps. It's easier than to lie flat on your back and let the wolves eat you.

"I've had my share of experiences, and since you fellows have been telling bear stories, I'll tell you what happened to me in the Rocky mountains. I had been nosing around where there were signs of metal, and was alone, because I thought I was sure to find it and wanted an undivided interest in the find. I had a gun along, of course, but I was always careless about guns, and sometimes I'd get interested in my work and leave the gun standing against a tree while I went poking around for signs.

"One day I found something promising, and got out my pick and went on the chase for it. I hadn't located it up to the time I ran into a grizzly bear that looked as big as an elephant. The weather was getting cold, and I thought the bears had retired for the winter, but I guess I was mistaken. Maybe this one had got caught out in the cold against his will. Anyway, there he was and there I was, and he looked as if he hadn't had a meal of victuals since berries were ripe. He made for me, and I went up the nearest tree, which wasn't nearly so high as I would have wished; but a grizzly can't climb, so I was safe enough for the time. If I'd had my gun I'd have had fun with that bear, but the blamed gun was around the hill, resting against a big stone, as harmless as a crowbar.

"It was getting toward the shank of the evening, and I thought when night came on, the bear would trek for home, so I made myself as comfortable as circumstances would permit and waited for my chance to go, too. But it didn't come. The moon came out shortly after dark, and it was so light that I guess the bear

didn't know what time it was. Whether he did or not, he staid at the foot of the tree watching me. At first he had ripped off the bark in wild attempts to get at me, but as time wore on, he wore out and settled down to a quiet life. In the meantime I began to get cold, and then a good deal colder, but the bear, cuddled up in his fur down below, didn't seem to be suffering much. Finally I got so cold and so cramped and tired hanging on to a limb not so thick as my arm, that it was all I could do to hold on at all. Then I was real scared, and I tried to scare the bear. But he wouldn't scare. He knew his business, and he was looking for fresh meat. At last it got to the point where I couldn't hold any longer, and I began to say my prayers before letting go and dropping into the grizzly's gizzard. At that moment I thought of my morphine. I had a bag of things I always carried over my shoulder, and there was a ball of twine in it, and with this I proposed to tie myself to the tree and swallow the morphine. Then, when I went to sleep, I wouldn't fall out. I didn't want that measly bear to get my remains, though I don't suppose he would have eaten much of me.

"I was winding off the twine when a great idea presented itself. If the morphine would put me away, why wouldn't it do as much for the bear? Possibly he could take more, but I had enough in my inside pocket to kill 40 men, and that ought to do for a bear, even as big as a grizzly. The thought put new life into me, and I braced up. I had some dried meat and other eatables in my little bag, and I had the morphine in my inside pocket. I got out the meat, a piece not bigger than my fist. I cut a hole in it and put in a few 5 grain pellets of the sleepy stuff. I had more, but I thought I would try that much for a starter. Then I tied the loaded meat to the string and let it down before the bear's nose. He was taking things easy at the time and the meat smelt good to him. Instead of getting mad and rising up to paw holes in the tree, he sniffed a minute at the meat, made a grab at it and down it went. I suppose I might have played fish with him, by pulling on the other end of the twine, but I wasn't feeling that way. I let the twine go, and, after shaking his head and pawing at his face, he got the string down where the meat was. Then he lay down again, with a look up my way, as if to say, 'When are you coming down?'

"I could hang on a good deal better then,

and I took a new hold, and waited for the dope to act. I didn't know the dose for a bear, but I hoped I had given him enough. For an hour I waited, and then the bear began to show signs of languor. He stretched out sleepily, and at last tumbled over limp, as if he hadn't any more use for himself. I thought it was my time, and down the other side of the tree I went as fast as I could. The way I got out of that neighborhood was a caution to snakes.

I ought to have been too stiff to make good time, but the scare took all the stiffening out of me, and I hustled like a catamount. I had sense enough to head for where my gun was, and I took that along. Next day I went back, prospecting for bear. I got him. He was deader than Julius Cæsar, from which I have always suspected that 20 grains of morphine is an overdose for a grizzly."



AMATEUR PHOTO BY J. E. TYLOR.

AN EARLY MORNING SNOOZE.

Winner of 16th Prize in RECREATION'S 8th Annual Photo Competition.
Made with Eastman Kodak.

Financier—I told me boss I couldn't afford to work for t'ree dollars a week.

Merchant—What did he say?

Financier—Said he hadn't noticed me tryin' to.—Judge.

EARLY DAYS ON THE YAKIMA.

J. E. NEWTON.

We had finished our work, and sitting in the dim light of the smoky lamp, we drifted into talk of early days. I was comparatively a tenderfoot, while Pard had come over the plains when a mere boy. We both owed our living to the Pacific railroad. He handled a big Klondike engine. I was known as the "cow coroner." To find how he had happened to hit a bunch of 3-year-olds on a straight track was what brought us together.

"Things have changed mightily since I came out here in '72," he said. "I don't recall much of the trip overland, though I have a vivid recollection of reaching our promised land, a beautiful spot on the Yakima, where it winds down Kittitas valley on its way to the Columbia. We worked hard putting up the log home, barn, hay skids and corral. There was timber without end, but it had all to be worked by hand. We had plenty of horses but of people there was only father, mother, 2 girls and I. However, we were all under cover, with plenty of hay for the stock, before snow covered the range.

"There was much discussion as to what we should plant on the bottom land. It was finally decided to plant hops. That meant considerable preparatory work, principally splitting poles for the vines to run on.

"When the hops were nearly ready to be gathered, the problem of who was to pick them presented itself. It seemed a stickler until it occurred to father that Indians might be utilized. There were many near, and with little effort a dozen or more were secured. They did the work well, living in their tepees a short distance from the hop field. I never tired of watching them at work or lounging about their camp. I came to know them by name and as they came year after year I gradually mastered their tongue, until at 17 I spoke Yakima as well as the best of them.

"About that time 2 Indians died; one a small boy, the other an old man. That broke up the camp, as this tribe will not live where one of their number has died.

"The mother and father of the boy asked my father for permission to bury the body on our land. It was given. The burial to me seemed pathetic. Father read the burial service while we and a few Indians stood with bowed heads about the grave. After the interment the parents of the dead boy moved away, and I learned they had gone to the Big Water (Pacific). A year later they returned, tired and travel

stained, and before eating or resting, they repaired to the little grave among the willows. Lying on the ground they gave vent to their grief in tears and sobs. Two days and 2 nights they kept that up, ceasing at noon each day to break their fast on dried elk meat, washed down by river water.

"Three years they returned to mourn beside the grave of their son; the fourth year they did not come, nor did I ever see them again.

"I saw many strange ceremonies during my years on the ranch; the potlatch at the termination of the fall hunt, the salmon dance, the rain dance and many others. The actions of the Indians when one of their number fell sick were amusing. They used the sweat bath in the skin house, then the sudden douche in cold water, accompanied by the beating of drums and boards and the howling of the family.

"It was during one of these treatments that a tall, giant Indian, who claimed to be a Umatilla from Oregon, said to me:

"These Indians are foolish. We have good doctor, he cure pretty near every time; use grass, rocks, roots. He cure me consumption, I have him 2 year. You don't believe, do you? Look!"

"He drew off over his head his cheap cotton shirt, disclosing his brawny, muscular breast marked with 3 hideous circular scars. They were evenly placed, one on each side and one in the center. They were, perhaps, $\frac{3}{4}$ of an inch across, whitish in the middle, the edges red and angry looking. The adjacent flesh lay in creases and folds, a sight to make one shudder.

"'You see,' said the Indian, 'he cure him that way. He get um 3 cottonwood root, dry, straight. He light um and smoke like cigar. When him good fire he push one here. He smoke hard and push him hard; pretty soon him go clear in. Then he make him squaw blow him hard. The doctor light him other one; pretty soon he go in, too, and squaw blow him, too. Pretty soon 3 squaw all blow him hard and smoke come out my mouth fast. Then I choke and go sleep; wake up in little while, pretty soon. Next day doctor do him again. Then he say pretty soon I get well. Dat 5 year ago. Umatilla, him never die consumption; doctor fix 'em all.'

"Truly he was then a picture of health, and from appearance as far removed from disease as is possible to imagine. Hop picking over, he went the way he came. I have never seen him since, nor have I ever heard of a similar cure."



AMATEUR PHOTO BY GEORGE HARTMANN.

A GOOD CATCH.

Winner of 15th Prize in RECREATION'S 8th Annual Photo Competition.

HOW SAM FLYNN WAS CURED OF OFFICE-SEEKING.

JENNIE P. BUFORD.

"You want to know how I got cured of orfis seekin'?" asked Sam Flynn, gulping down his inclination to stammer with a mighty heave of his larynx. "Well, I'll tell you, ef you can stan' my stuttering," he said with a stress of sibilation not indicatable by type.

"Sence I was er small boy I always hankered to hold an orfis, an' arfter I growed er man, an' see how comfortable people was what lived onter the public corner I jes-felt bound to git er public job. I knowed my stammerin' was agin my running' for orfis, but then I 'membered everyone had sumpin to pull him back. Besides, thar was er man up North what guaranteed I would never stammer so long ez I follered his advice, and all he wanted was \$5.

"I reasoned this er way: Ef I got an orfis I could afford to pay to get cured, so I made up my min' to run for the orfis of magistrate in my destrict.

"Fore the spring 'lection I zerted myself uncommon. I sat up all night any time with sick neighbors; I took er class in the Sunday school; an', for all I was born tired, I went to 3 log-rollin's. Arfter people foun' out I was goin' to run they was sholy kind. The encouragement they give me steadied me might'ly. Some of 'em would come over an' hear me speak my speech I had ter make at the barbecue, an' they helped me so I could get it off 'ithout stuttering a stut.

"At larst I was 'lected by a majority of 3 over that slick, likely nigger, Sol Stanback. This was er plenty, for, 'lowin' 2 for cheating, which is always claimed in this deestic, I felt purty safe that there would be no contest. Now, I thought, I can risk that \$5 an' git cured an' serve my fellow-citizens all the better. I borrowed \$5 from my wife's egg money, an' sent it off the night after 'lection to that feller up North what advertised that he could sho cure ef I'd do what he told me. Guarantee is a

mighty big word, an' that feller said p'intedly he'd guarantee a cure ef I'd sen' along \$5. 'Twarn't more'n 3 days arfter I sent for my cure fore I had a case to try. 'Twas that same slick nigger what had run agin me; he was up for fightin' another nigger. I allers will b'lieve 'twas a put up job, for nobody looked mad at all.

"Somehow, I seemed to get natchally confused an' stutery. Still, as I had nothin' agin Sol for runnin' agin me, so I thought he oughtn't to have anything agin me for beatin' him. Sol sat lollin' in his seat, showin' no respec' whatever to the court, so I said, quiet an' composed, 'Stan' up,' lookin' plum' at him.

"He sot stark still, an' laughin' impertinent, he says, 'My name ain't Stan'up, it's Stan'back.'

"'Stan' up and behave yourself,' I said again; but I stuttered turrible this time, for I was gettin' mad. Then he says, 'Ef you talkin' to me, you call me by my right name,' and' he jes' wallered in his seat to make me madder.

"By this time I was bilin' an' I far'ly roared out to him, 'Stanback!' Would you b'lieve it, that nigger jumped up so sudden an' so straight that he tuk 'way all my senses? Thar I stood, sayin', 'Stan'—Stan'—Stan'—an' I couldn't get any further. All of er sudden I got giddy like an' didn't know any more. When I come to, I was at home, feelin' pretty weak. That night I got my letter from the feller what was to cure my stutterin'. My han's fumbled, I was so anxious to get cured an' get even with that impident Sol Stanback, but I got it open somehow. The letter looked mighty light an' no 'count, but I had the guarantee on him an' I felt right safe. Your dicsurnery ain' got the words in it I said when I read this flabbergastin' advice:

"Keep your durn mouth shet."

Stranger (overtaking native)—What's the matter here? Every house for the last 10 miles is closed, and you're the first person I've seen. Got the plague here?

Native (whipping up his horse)—Nope. Autymobile race ter-morrer, an' we're git-tin' out o' danger. Gedup!—Judge.

THE TRUMPETER SWAN.

ALLEN BROOKS.

This, the largest and noblest of American game birds, is now rarely found East of the Mississippi valley. Westward to the Pacific coast it is more common, in some localities being much more numerous than its smaller congener, the whistling swan. From the latter species it can always be distinguished by its greater size, and the absence of yellow on the bill of the adults.

The breeding range of the trumpeter swan extends from Northern British Columbia to far North of the Arctic circle. In August the old birds lose all the flight

tone. It can be heard at an astonishing distance, though when close to the birds it does not sound extremely loud.

I have found the trumpeter a far more difficult bird to call than the whistling swan, probably due to the call of the trumpeter being more difficult to imitate.

Trumpeter swans take an astonishing amount of killing. I have known them, several times, to fly right away with 30 caliber soft nose bullets through them. To kill them with shot is difficult, I have found it best to use No. 2 or 3, and shoot



TRUMPETER SWAN. *OLOR BUCCINATOR.*

feathers by moult, and can then be run down and captured. In Southern British Columbia the trumpeter arrives about the end of October, frequenting certain localities year after year, and remaining throughout the winter as far North as open water and suitable feeding grounds occur. The flocks generally are composed of one or 2 pairs of adults and double that number of gray plumaged young. Where numerous, the flocks do not mix except when feeding. When put up they fly away in separate strings, following their respective leaders.

The note of the trumpeter swan is a low pitched, hornlike call, with a decided nasal

at the head. The larger sizes of shot more generally used, seldom penetrate sufficiently to kill, and their pattern is too scant to try at the head.

When properly roasted, trumpeter swans are delicious eating, except probably the oldest birds.

The head and neck feathers are generally much stained with a golden rusty tipping, no doubt caused by water impregnated with iron. The iris is dark brown; bill and feet in the adult are black, in the young brownish, or grayish, irregularly marked with yellowish flesh color.

HOW I LOST MY GUN.

OTTO VON STOCKHOUSEN.

A few years ago I saw an offer in RECREATION of a single barrel shot gun as a premium for 10 subscriptions to RECREATION, and being a boy 15 years old this offer, of course, appealed to me. I went out among my friends and soon got the subscriptions necessary to secure the prize. I sent them in, and in due time the gun arrived. It was a beauty, and I was eager to try it on game. As soon as the ducking season opened I started with a friend for Pewaukee, where we arrived early in the morning. We ate our breakfasts as quickly as possible and were out on the lake a little after sunrise.

Game was scarce, but I was fortunate enough to get a mallard with the first shot I ever made at a bird on the wing. You may imagine how rapidly my head grew in size.

We had fairly good shooting during the forenoon, and after dinner I was anxious to go out again. My friend at first declined, saying he preferred to rest a while; but he finally yielded to my persuasion, and we started, that time in 2 boats.

I followed the shore of the lake some distance and finally got one teal. Then I pushed into a cove among the rushes, hoping to jump other birds. A big mallard got up. I dropped my paddle, picked up my gun and let go at him. He had passed me so far that when I fired I lost my balance, and in order to save myself I dropped my gun, the first and only one I had ever owned! A few air bubbles that came up showed where it had gone, and my heart sank within me as if it had suddenly turned to lead. I called lustily for help but none came. I began fishing for the gun with my paddle, but the water was 5 feet deep, and though I could occasionally touch the gun I could not raise it.

Finally my friend heard one of my yells and came to my assistance as fast as possible. He thought I had fallen overboard and was about to drown.

As soon as he came within hailing distance he asked what was the trouble.

"I've lost my gun."

"Is that all?"

"Yes, that's all. Isn't that enough to kill anybody?"

By that time he was alongside and began fishing for the gun with his paddle, which fortunately was longer than mine. He soon located the gun, and said if he could only get his paddle under the muzzle he thought he could raise the gun. He worked a long time without success, and finally advised me to undress and dive for the gun, but that was late in October, and the water was almost ice cold. However, I took off my coat, vest and shoes and started, but when I put one foot in the water I weakened. Then the boss continued his efforts to raise the gun. Finally he said,

"I have it, it's coming."

Sure enough, the muzzle came slowly in sight, but was still 2 feet beneath the surface of the water. When he got it up as far as he could I made an eager grab for it, but just before I reached it, though I thrust my arm in up to my shoulder, the gun slipped and went back.

Then another long course of prodding, prying and trying. At length the coveted muzzle again came in sight, and the boss said,

"Now then, Otto, go after it easy this time."

I waited as patiently as possible until the gun stood upright and the muzzle was within about 18 inches of the surface. Then I reached down slowly and carefully and finally succeeded in grasping the steel tube. I uttered a yell that would have frightened a wooden Indian, but I landed my gun in the boat all right.

All that time the cold October wind had been blowing through my shirt and skin and was chilling my bones. I had not realized it, but when the trouble was over I discovered that I was nearly frozen. I jerked on my coat and vest, caught up my paddle, and pulled for the shore as fast as I could drive the boat. When the bow struck the ground, I made a jump and lit out down the trail for the house, touching only the high places.

When I thawed out, I took the gun apart, cleaned and dried it thoroughly, oiled it, put it together again and it was just as good as new.

"Your salary isn't enough to support my daughter, sir."

"I'm glad you've come to that conclusion so early, sir."—Detroit Free Press.



AT THE LANDING AT CAMP COQUINA.



AMATEUR PHOTOS BY FREME ROHEBOUGH

ON THE RIVER, LOOKING FROM CAMP COQUINA.

SIGNS OF SPRING

E. C. M. RICHARDS.

When the ice has started melting,
 And the snow is almost gone;
 When the skunks have started mating,
 And the trout begin to spawn;
 When the geese come honking Northward,
 Over valley, hill and fen;
 When the woodchuck leaves his burrow,
 And the chipmunk leaves his den;

Then the old grey bearded woodsman,
 With his rifle and his traps,
 And his old, but knowing, mongrel hound,
 All cut and scarred from scraps,
 Leaves his cosy winter quarters,
 Nestled close beneath the hill,
 And starts his muskrat trapping,
 By the river, brook, and rill.

THE DISSOLUTION OF ABIJAH DUSENBURY.

DR. G. A. MACK.

From far above the timber line, the snow-born Occamo comes, in puny turbulence, to seek tranquillity in the Columbia and ultimate Nirvana in the broad Pacific. It reaches the evergreen scrub a brawling little torrent, leaping sheer cliffs, boiling furiously around obstructing boulders. In the timber it broadens beyond the leap of the most agile deer. Though foam-flecked always, its waters flow in ever lengthening reaches from ledge to ledge, pausing a moment in the deep pool at the foot of each fall to gather energy for another rush.

The trees of the second growth forest through which it speeds are already large enough to tempt the lumberman. Soon they will follow the great conifers that shadowed the stream when the Wenatchee range was a fastness for the warriors of the Lummi. Here and there, standing for the most part on inaccessible cliffs that saved them from the ax, giant pines still lift their age-gnarled branches. The tallest of these pines can view, beyond the woodland and beyond an ever widening champaign, the shimmer of the sea.

What they may no longer behold, is the wood life of their prime. The last bear and mountain lion of this region exist only as moth-eaten pelts. The deer are gone, save an occasional fugitive driven into the valley by a pack of hounds or string of howling beaters. A few grouse remain, but they no longer strut and dust themselves in the disused lumber roads. They keep to cover; for the market is not far, and they have learned their value.

Yet to that stream there came, one summer day, 2 men. One, long limbed and ramshackly, carried a scap net and an empty feed bag. The other, a chunky, red faced chap, carried himself only, but with an air of might.

"I tell you, Cal," he was saying, "this rod-and-line business makes me tired. The feller's a fool that will wade all day for a few fish."

"But, 'Bijah," returned the tall one, "we'll have walked all day by the time we get home."

"Mebbe," said Abijah; "but by night you'll have all the load you want to tote."

"They say a feller at Moquash got his arm blown off last week," remarked Cal dubiously.

"Then he didn't understand himself," replied Abijah. "I've played this trick before and know how to do it. We'll start in the

big pool by the dead pine, and then try higher up."

Reaching the pool, the men sat down to rest. Pipes were filled and lit, and the tall man passed a flask to his companion, after taking a pull at it himself.

"We must go light on this," said the chunky one, with an appreciative smack; "you'll need it going home."

Presently he produced from his pockets 2 things like hypertrophied firecrackers. Observing that he handled them rather gingerly, his friend rose suddenly and walked along the ledge, as though to view the stream. This maneuver did not escape the red faced man; his eyes twinkled.

"Come here," he cried, "and sit down while we arrange this thing."

Cal turned and came toward him—not too near, however—and remained standing. Abijah chuckled.

"Pooh!" he said, "when you've bust as many of these as I have, you won't be afraid of 'em. Now you go down the creek to the first riffle. All the trout we knock silly will float down there and you can gather them in with a net. Never mind the small ones. When you get there, holler. Then I'll chuck in the sudden death and let her zip."

"All right," said Cal, evidently relieved at his assignment, and he disappeared in the direction of the riffle. Soon his voice announced that he was on guard.

The red faced man went to the edge of the rock overhanging the water. There he put one of the bombs in his pocket, shortened the fuse of the other and, lighting it, tossed it deliberately into the center of the pool. Then he turned to run. In doing so, he stepped on a pebble and it rolled under his foot. He lost his balance, and, wildly flourishing his arms, fell headlong into the water. His splash was followed almost instantly by a muffled explosion, with a peculiar dual quality of sound. A great white column rose from the brook, hovered an instant above the tree tops, and fell back into the pool with a sullen roar.

Down the single street of the hamlet of Blagden came, that night, a man, tall and loose jointed. The moon shone on his flushed face and lighted his eyes with a vitreous sheen. The limber eccentricities of his gait were greater than could be accounted for even by his shambling build. In one hand he had a long handled scap net; in the other, a partly filled bag, which

he carried with care well away from his legs. Occasionally he used the net handle to arrest his little involuntary excursions to one or the other side of the road. Coming in this devious fashion to the village store, then closed for the night, he stopped and looked about. He laid the bag and the net on the stoop, and, with a weary sigh, seated himself between them. For a time he sat motionless and silent, thinking deeply. Finally he raised his head, and, with a wide, inclusive gesture, addressed a row of pickle barrels.

"Come," he said, "lesh reason 'bout thish thing. Puts me in mosh embarrassin' position. Me an' 'Bijah Dusenbury went fishin'. There was a 'splosion, an' 'Bijah, wishout statin' any teshtamentary wishes, went to that bright bourne where they don't need punk.

"Now, ish my bounden duty," he continued, with a sidelong glance at the bag,

"to take thesh few remainsh eisher to coroner or to bereaved family. If I go coroner he'll shay, 'whersh resh of 'im? Howsh jury goin' formulate theory on thish meager data? If thish is 'Bijah, who'sh goin' know what killed him? Pr'aps you poisoned thish man; pr'aps thash why didn't bring his stomach.'

"An' if I take 'Bijah's relics to his relict, it'll be worshe yet. Howsh she goin' put his besht black suit on 'im? Howsh mourners going press kish on pallid lips of departed or drop tear on's alabaster brow, when I couldn't fin' his durn ole head? Howsh they goin' put *hic jacet* over's ashes, lesh they dynamite a tombstone factory?"

"Nosher thing; lesh 'Bijah begins get himself toghesher d'rectly, he's bound delay the reshurrection!"

And, wagging his head dolefully, the tall man resumed his burdens and his way.

PORTRAITS OF A NEIGHBOR.

Enclosed I send you photographs of a little wren that built a nest near our house.



DO I SEE A WORM!

When I first tried to take the photos the wrens were much afraid of the camera. I put a black cloth over the camera and stood quietly by the tripod until the wren came to the post to see what was taking place. Several times I practiced this until one bright morning, with stop No. 6, 1-50 second, medium plate, I took both of the

photographs. I made 6 exposures before I succeeded in getting one print that would develop clear. I tried first to use the back combination of the lens, but the subject being so close and the plate so far from the lens it was under exposed.

W. S. Olcott,
Lyndon, Kas.



AMATEUR PHOTOS BY
W. S. OLCUTT.

GRACE AFTER MEAT.

A girl in the arms is worth 2 in the push.—Life.

"You never applaud at a concert."

"No," answered Mr. Cumrox. "If I enjoy a piece well enough to applaud it, I know it isn't the sort of music mother and the girls would approve of my applauding."
—Washington Star.

ON A RUSSIAN RIVER.

BARON PAUL TCHERKASSOV.

The remarkable reflection of a bridge, appearing in the September issue of RECREATION, reminds me of a similar case of perfect reflection, a photograph of which I mail you herewith. This was taken on the river Kama, in August, 1898. It is nothing to boast of in technique, and not to be compared with Mr. Burritt's production, but it was taken under peculiar conditions of light, etc.

In the early part of August, 1898, I was on my return journey from the Altai district of Siberia, where I had spent nearly 2 months. Branching off at Tcheliabinsk toward Yekaterinburg and Perm, we had to travel all the time through large tracts of forest, some parts of which were ablaze. The scene, at night, was weird and grand beyond description, but made one's heart ache for the forests thus devastated. At Perm we left the rail and took the splendid steamer Berezniky, of the Lubimov line of steamers, for Nijni-Novgorod. The weather was glorious, and I spent most of the 24 hours on the promenade deck, breathing the balmy air wafted from the pine clad slopes of the high right bank. The scenes of destruction, the reek of the fires, were forgotten till we neared the mouth of the White river, Belava. There the air was laden to such an extent with the smoke of distant forest fires that the sun stood out like a dull, orange disc; so dull, in fact, that one could look at it with little inconvenience, as at the moon.



AS IN A LOOKING GLASS.

The surface of the river was perfectly calm; not a ripple, not a breath of air; not a sound beyond the throbbing of the steamer's engines and the churning of her powerful wheels. Of a sudden, from behind a bend of the bluff on the left bank, another steamer appeared, going up stream and keeping close to the left bank. Her reflection in the water struck me as exceptionally clear and fine, and I risked a snap shot at her, while our steamer was tearing along, full speed, toward her in her course down stream.



AMATEUR PHOTO BY WM. H. FISHER.

RIGHT ON THEM.

Winner of 19th Prize in RECREATION'S 8th Annual Competition. Made with Eastman Kodak.

A small boy in a Pennsylvania school produced the following as his contribution to the closing exercises in English composition: "King Henry VIII. was the greatest widower that ever lived. He was born at a place called Annie Domino, and had 51 wives, besides children and things. The first was beheaded and afterward executed, and the second was revoked. Henry the eighth was succeeded to the throne by his great grandmother, the beautiful Mary Queen of Scot, sometimes called the Lady of the lake, or the Lay of the last Minstrel."—The Pilot.

An optimist falling from a 10th story window, called out cheerfully as he passed each story, going down, "All right so far!" —Exchange.

BRISTLEBACKS IN THE YOSEMITE VALLEY.

It remained for a trio of anglers, Claude Shafer, Gus Gobel and Harry Edell, the latter a well known sportsman of this city, to shatter one of the traditions woven about the trout fishing in the Yosemite Valley.

For years sportsmen have seldom caught more than one or 2 trout a day in the valley, but Messrs. Shafer, Gobel and Edell were equipped with a knowledge of woodcraft and with skill as anglers. The trout were not rising to the fly during their recent visit, but they soon found what bait would tempt the shy fish from the deep pools. For 2 weeks their daily catch averaged more than 80 fish. These ranged in weight from half a pound to 2 pounds. After supplying their own table the remainder was distributed among friends who

caught, as the streams were whipped to death by anglers for miles all through the valley. The water was clear, which made the fish shy. The enclosed picture shows you our last day's catch.

Harry Edell, San Francisco.

It would be interesting to know just how these men really did get their fish. If the stream in question was whipped to death, as Edell states, and if other men were getting only 2 or 3 trout a day, how could these chaps possibly make an average, in any



GUS. GOBEL, HARRY EDELL, CLAUDE SHAFER, SAN FRANCISCO.

were enjoying a visit to the valley.—San Francisco Call.

To my inquiry regarding the truth of this report I received the following letter:

San Francisco, Cal.

We had great sport in the Yosemite valley and it is true that we caught an abundance of trout, although we met any number of anglers with not over 2 or 3 fish as the result of a day's work. We fished about 6 of the 10 days we spent in the valley and averaged over 80 a day, or over 500 in all. We had to work for every one we

legitimate way, of 80 fish to each man for the 6 days? I have no doubt they got the fish, but every honest man who reads Edell's letter will wonder how they got them. Men who will slaughter fish at such a rate and then string them up and be photographed with them, would not hesitate to use a net or even a stick of dynamite occasionally; and although these men parade their fly rods and their fish baskets in the picture, suspicion will lurk in the mind of every reader of RECREATION.

Shafer's number in the fish hog pen is 969, Edell's 970, and Gobel's 971.

Aspiration + perspiration = inspiration.—
Life.

MY TRIP TO WOOD'S CANYON.

[(Report of Edward Cashman to Captain Abercrombie, U. S. A.)

I left Valdez October 18th with 4 companions, to recover 13 horses left in Wood's canyon. One of these men, Charles Anderson, made the trip from Sawmill camp, on Klutena river, to the soldiers' camp on Low river in 1½ days. We had 2 days' supplies. Our first stop was at Dutch camp on Low river. The second day we camped with the soldiers who were cutting trail. The trail from Valdez to their camp was good. The third day we left camp at 8 o'clock and at 10:30 were on top of the divide. The trail up the divide was clear of brush, and on the top was level. On our left was a bluff and a small lake.

We were about half way around the lake when we saw a bear. Going through the pass we saw another bear sitting on a rock. We arrived at the banks of a large river at one o'clock, and camped the rest of the day. We looked for some flour which the soldiers told us was there, but found none. The next day we broke camp at 8 a. m., went down the valley 2 miles and started through a small canyon to our left. We broke through the ice several times, my boots getting full of water. Beyond the canyon we found a small glacier. It took us from 11 until 4 to cross it, traveling through 2 feet of snow, which was falling all the time. Beyond the glacier we entered a small valley, all rocks. We could go no farther, as it was dark. We walked around a large rock all night. At daylight we started out and at 10 o'clock found some wood. We built a fire to thaw out. It took half an hour to get my boots off, and I found all the toes of my left foot and the great toe of my right foot frozen. We rubbed them with snow and went on down the valley. It began to snow, and we could not see 10 yards. We traveled 4¼ hours, then came back to our camp fire again.

About that time we concluded we were lost. In the morning we climbed the mountain, but could not see because of the thick weather. Several days were lost in that way. One clear day while I was on the mountain I saw a large lake. I suggested that we go to the lake and find out where we were. We started down a stream which came from the glacier, crossed it and followed it several days, walking on the ice, as the stream was freezing. The streams freeze from the bottom, then from the side. In going down we saw tracks of bears and wolverines in the snow, and found where a bear had been fishing for salmon. Both stream and lake were full of large salmon. We saw 9 bears in the woods. It took us a day to walk around the lake, when we

struck what I recognized as the Quartz creek trail. We were so weak by that time we could hardly travel. When I told the boys we could get to the rapids in a day, it braced them up; but it took us 1½ days to get there.

When we arrived at the camp the people could not do enough for us. Through the kindness of Dr. Townsend, who treated my toes, and Mr. Fishline, who gave us provisions, we were soon on our feet again. My companions stopped there and I left for Copper Center. We had been 8 days without eating. It had taken us 11 days to make the trip, but I could do it again in 4. We kept too far to the Northwest. In my opinion a good trail can be made to Copper river via Low river.

I left Copper Center November 1st with Jack Stewart and Joe Ham. We were 2 days getting to Nicolai No. 2 wigwam, and stopped there 2 hours.

We left Copper Center Monday. The river was full of mush ice. Wednesday we stopped at the mouth of Tonsena river to deliver a letter to Mr. Fritts, who was wintering 12 horses there. We had a hard time on account of cold and ice. Friday we were caught in the ice jam, and our boat was lifted 8 feet in the air. We had to use the seats of the boat for snow shoes to reach a shoal 100 yards from us, as the ice was not solid enough to hold us. We camped on the shoal and at 3 the next morning were awakened by the ice moving. We were like rats in a trap. Our boat was gone and the ice was moving all around us. It piled up, cake on cake, 15 feet high in the middle of the river. It was forced up on the shoal and stopped within 3 feet of our tent. At daylight the ice stopped moving and was solid enough to walk on.

Some Indians came over and helped us pack what was left of our stuff to the bank of the river, which there was about 2 miles wide. We were almost opposite Kotsena river. It took us till Monday morning to pack our goods to where we found the horses. Nine were alive and 3 dead, and one was missing. We found him later on the river flats. One leg was broken and his tongue hung from his mouth, which was frozen shut. We shot him. Stewart and I left Ham to watch the horses and went down to Wood's canyon to find a crossing to Taral. The Chittyna river was about one mile above and was open as far as we could see. We found a place where the ice had jammed, crossed to Taral and found the old squaw of whom you bought fish when

we went down the river. She remembered me. There was also a buck who had just come up from Algonick. We could scarcely make them understand what we wanted. When we asked for the saddles they thought we meant Seattle. They could *sabe* San Francisco and Seattle, but not saddles. The Indian whose *cache* they occupied lived at the mouth of the Chittyna, and as he had the cabin locked and was away, we had to wait.

We took the Indian who was at Taral, and tried to cross to the horses, but the ice was gone and there was no way to get across. The Indian invited us into his shack and we were glad to go, as it was extremely cold and we had left our blankets on the other side. This Indian could talk good English, as he had worked at Eyack in the summer. The Indians treated us well. They brought out their chinaware and gave us beans, fruit, bacon, tea, sugar, lard for butter, and baking powder bread. They also had boiled salmon. The old squaw, in honor of having white men in her shack, put on her best sack, made of a red handkerchief. She was prouder of it and her chinaware than white women are of their sealskins and silver. We slept that night on the floor, rolled in a moose skin. For breakfast we had beans, tea, berries, and their last piece of bacon. After breakfast the old woman took the platter from which we had eaten beans and licked it clean. She then boiled some salmon and had her own breakfast. She offered us some, but we declined. When we were ready to start she fell over herself trying to thank us for sleeping in her house. She said, "Tanks, tanks! White man hi-yu; you good white man sleep here," etc. She would not let us thank her or give her anything.

We had to go down about 3 miles from Taral in Wood's canyon before finding a crossing. The Indian with us had never seen a horse. He saw the one we shot and wanted to know if we would "pot catch hima" the skin. We did so, I letting him have my knife to skin it with. He stopped with us that night, unwillingly, as, for some reason, they do not like to visit this side of the river. We helped him pack the horse skin and by the time we reached Taral the other Indian had returned from Chittyna. He gave us 4 pack saddles, 2 riding saddles, 14 halters, one saddle bag, 2 bridles and a lot of rope. They helped us pack them to the other bank, but would not go up where the horses were. When we bade the Indians good bye, they asked whither we were going. We told them up to the Tasnuna. They said we could not, as it was "hi-yu rock and 5 sleep." They would take nothing from us, because we had so little ourselves. They told us to come back to them if we were short of grub and they

would supply us. They said, "White man ha-lo muck-a-muck. Indian hi-yu muck-a-muck. One moon hi-yu cold white man no muck-a-muck. Indian potlatch hi-yu muck-a-muck. One moon hi-yu cold, hi-yu wind, white man die"; which we found nearly right.

We had hard work to catch the horses, as they were half wild. Built a rope corral and got them in it, but they broke through 3 times. We then felled trees and built a log corral and drove them in. We had to pen them in a corner and pile logs around them before we could get the halters on. We then started down the river, but the horses could not walk on the ice. They kept breaking through and slipping. We started over the hills, but after 10 days hard traveling had to turn back, as the country was full of canyons running at right angles to Wood's canyon. By that time all our supplies were gone, except one pot of beans. We used to stay up at night to do our cooking, as the days were so short we did not have time to cook. It became dark about 2:30 p. m. and light about 8:30 a. m. Every night we would secure a rope between 2 trees and then tie the horses on each side near the fire. When we pulled the halter of one of the horses he would pull back. Once a horse pulled back and fell on the fire and our last pot of beans. We could not get him up and had to pull the fire out from under him. He was badly burned around the legs. We lost our beans and had to go hungry that day and the next until we came to an Indian shack where they gave us salmon and tea. They did not have anything else. We slept in the shack.

In going up the hill at Wood's canyon a horse caught his pack in the roots of a fallen tree and fell. He rolled over and over like a rubber ball. We heard him coming and had to hustle to keep out of his way. He went by us like a shot, heels over head. We thought he would be badly injured and took a gun down to shoot him, but when we arrived at the foot of the hill he was standing drinking at a hole in the ice, his pack in place and not a scratch on him. The weather at that time was exceedingly cold and growing colder. Our fingers and faces were frost-bitten. Then the horses began to give out. They would lie down and not get up. We lifted one up 4 times, but he could not go over 50 yards before he would drop again. We were compelled to shoot 4 horses in one day. One broke through the ice and we had to go back to an Indian shack to get an axe to cut the ice around him. We hitched 2 horses to him and pulled him out. As soon as he got out he froze hard as a rock.

As the Indians up this part of the river were short of grub we cut this horse up

and lived on him for 4 days till we arrived at the Tonsena, where Mr. Fritts made us stop 2 days to rest and thaw out. He told us it was 35 and 40 degrees below zero. We had 3 horses and a mule, but had to shoot one horse there, as it could go no farther. Mr. Fritts treated us very kindly, giving us all the flour he could spare. He was short himself and as his *cache* was at Copper Center he could not give us much. We had lost all track of time. He told us it was about a week before Thanksgiving.

We left there with 2 horses and the mule. We packed our grub on one horse and our bedding on the other horse and the mule. The first day in going down a hill from the Tonsena, Stewart led a horse half way down, when the mule slipped and rolled down on him, knocking him and the horse over. All 3 went to the bottom together, but without damage. The other horse turned and ran back on the trail, scattering our grub and what was left of the horse meat. I headed him off 3 times, but he dodged me and got away. We found the most of our grub. The horse meat we could not find. It was a very cold day and the night was much colder. We made Nicolai No. 2's house at dark and were glad enough to sleep there. The next night we camped at an abandoned Indian shack. When we stopped we were so cold we could hardly light a fire. My moustache and whiskers were frozen solid and as my mouth was open I could not speak until we started a fire and thawed out.

The next day we had nothing to eat except 2 flapjacks, made of flour and water. At night we built a big fire. It was so cold we did not go to sleep, being afraid we would freeze. We had 8 large trees ablaze. Stewart froze his legs sitting on a log, and my heels froze. The next day we had half a flapjack each, and only flour enough left for another in the morning. The night was colder than the previous one. We built 2 fires and stood between them. About 4 o'clock in the morning we were half asleep when we heard a noise among the camp outfit and looked out just in time to see the mule eating the last of our flour. We got nothing to eat for the next 2 days until we came to Stickman's house. The Indians at that shack could not do enough for us. All they had was dried salmon and tea. They gave us all we could eat. They even tried to get the horses into the shack. We asked them how far it was to Copper Center. They said "halo sleep," meaning we could make it in less than a day. We were glad, as we were knocked out and the horses were in poor condition. We arrived opposite Copper Center Thanksgiving eve, and were obliged to leave the horses, as the Klutena river ice would not bear them. As it was, when we crossed, we broke through several times. When we got to Mr.

Amy's cabin they told us it had been 65 degrees below zero the last 3 nights. We ate supper at Mr. Amy's, then went to Mr. Fisher's cabin and had another good supper. Then we went to the hotel and had another supper. Notwithstanding this, we still felt hungry. The next day, Thanksgiving (and we felt thankful, too,) we took the horses over and left them in charge of Mr. Flynn.

We then started for the Rapids camp, arriving at 5:30 p. m. As our *cache* was at the Rapids, we stopped 4 days and filled up on all the good things they had to eat. We then started over the glacier after some grain. It took us 2 days to get to Twelve Mile camp at the foot of the glacier. Klutena lake was frozen over. From the upper end of the lake we broke trail on snow shoes, the snow being one to 12 feet deep. When we arrived at Twelve Mile camp the snow was so soft we would sink to our hips at every step. We stopped at Saw Mill camp for dinner and to thaw our moccasins. In going from Saw Mill to Twelve Mile camp, 3 miles, Stewart froze his feet so badly he could not move the next day. The people at the camp were glad to see us. They heard we had gone down for the horses, and, as the weather was so cold and stormy, they did not expect to see us again. I stopped with Mr. Nolan, of Jefferson City, Missouri, who treated me kindly and cautioned us not to go over the glacier. He showed us a Norwegian named Evyan, who had frozen his feet trying to cross and whom Dr. Logan, who afterward lost his life trying to get 2 sick men out in February, was treating. Dr. Logan came in that evening and I helped him dress the frozen feet. He advised us not to try to go over the glacier. The doctor also treated Stewart's feet. The next day, while Stewart was resting, I started to go to the foot of the glacier, a distance of 4 miles. It took me 4 hours to go 200 yards. The snow was 14 feet deep, and was light and dry. I would sink to my waist at every step. When I returned to camp, Dr. Logan told me that he would not allow us to make the attempt if he had to stop and watch us. That night Evyan died. The next day Stewart and I hit the back trail, as we were afraid of getting caught in a snow storm. Every snowfall averaged 3 or 4 feet up there. It was well we started at the time, as the next day it began snowing and it was a week before anyone could get from Saw Mill to Twelve Mile. We went back to the Rapids and we moved our *cache* to Copper Center.

Christmas day I parted with Stewart, who went up the river to Forty Mile. I stopped at Copper Center for a time and helped a friend up as far as Gakona river with his outfit. The weather at Christmas averaged 35 degrees below zero at Copper Center.

While I was up the river in January it dropped to 55 to 60 degrees. I froze my fingers and feet again. When I left Copper Center February 1st, there were a number of men sick in the hospitals and cabins. It took me 5 days to get to Valdez. I spent one night on the glacier at the fourth bench. The next morning I left there at 8 o'clock in a snow storm. It was 6 when I arrived at Valdez. I reported to Charlie Brown, the Quartermaster, the next morning.

I left a mule and a horse at Copper Center. I also left 2 pack harnesses and 2 halters. The mule died January 16th. The horse came over the glacier and is now at Valdez. I left all the other gear at Mr. Fritt's place on the Tonsena, as we were not able to carry it. Joe Ham, who went down with me, also stopped at that place.

All the Indians whom we met down the river treated us most kindly. They would come 3 or 4 miles to meet us and invite us to their houses, where they would share their food with us. They make excellent tea by mixing a native leaf with English breakfast tea. They make their tobacco by rolling a piece of gunny sack in wood ashes. They prefer this to our tobacco. Whenever we went to their houses, they would seat us close to the fire and look us over. If our mittens or moccasins were torn, they would take them from us and repair them. Stewart's moccasins, which were worn out, were replaced by a new pair, made of moose hide in half an hour by a woman, who would take no pay from him. She seemed happy, however, when I gave her a large safety pin, such as we use in fastening horse blankets. Another night, after they had repaired our stockings and mittens, I showed one of the Klutches where Stewart's trousers were torn. She wanted him to take them off so she could fix them, but he was bashful and would not do so. Before he realized it, 3 Klutches caught Stewart by the arms and held him while one pulled off his trousers. He yelled to me for help, but it was such a funny sight I could do nothing but laugh. The Klutch fixed the trousers in good shape and was well pleased when I presented her with 3 old red handkerchiefs. We found them very pleasant and sociable. We would sing and they would sing.

The Indians knew such songs as John Brown's Body, Marching Through Georgia, and A Hot Time in the Old Town. They had some cheap accordeons. Some of them had cast iron cook stoves, which they did not use, preferring the camp fire. The women do all the work. No matter how often a buck goes out, he must have a cup of tea. When he returns, he eats first; then the women. What is left is flung to the children and the dogs. I saw a child about 4 years old fighting with a dog for a piece

of dried salmon. One of the bucks got mad because I took the salmon from the dog and gave it to the child. They think more of their dogs than of their children. In cold weather the bucks live in stone houses, about 8x10, dug out and covered with logs and earth. You have to go in feet first, and once in with 10 or 12 naked Indians you are glad to get out. Their women sleep in the living room with the dogs and children. We always slept on top of the benches over the Klutches. The only Indian we found living like a white man was the one at Taral. All have their own chinaware and a box to keep it in. There are 8 or 10 families in each shack. The Indian whose bench is on the right side of the camp fire as you enter, considers you his guest, and will feed you, but the one on the other side will not. All the bucks look like consumptives. The women, as a rule, look healthy. They wear but one garment, a long skirt, open at the breast or as far down as the waist, extending a little below the knees, and a pair of moccasins reaching above the knees. This is the dress of the women and children. The bucks dress in various styles, some with mackinaw cloths, picked out of the river, others with what white men give them. One buck had on 3 hats, one on top of the other. They all have 45-90 rifles and cheap 32 caliber revolvers, but no cartridges for the latter.

The uniform you sent with me was as good as a pass for us. All we did was to show it and ask for Nicolai, and they could not do enough for us. They wanted to know if McKinley was hi-yu white chief. Nicolai was 25 miles up the Chittyna river when I arrived at Taral. I gave the uniform to the Indian who helped us over the river with the pack saddles. It was about 4 sizes too small for him, but he managed to squeeze into it. The Indians at the mouth of Katsina river had some good pieces of copper, which they told me they got on the Katsina and Chittyna rivers.

The country traveled through at Wood's canyon was rough, but well wooded, with large quantities of grass in places. When I left Copper Center, for Valdez, the snow was 39 inches deep. At the lake it was 5 feet deep, at Twelve Mile camp 15 feet, and at the foot of the glacier I could not reach bottom. It must have been 20 feet deep. Compared with last winter, I found little snow on the glacier when I crossed it. Coming over the fourth bench the ice bridge was not covered. I broke through in one place between 2 ridges and found only 2 to 3 inches of snow bridging the crevasse. I came out to Valdez with the same rig I had on at the Center, and felt the cold more than I did on the inside, yet they told me the lowest temperature at Valdez was 8 degrees below zero.

THE REGENERATION OF WINDY.

CHARLES A. HARMON.

Windy was the original Mr. Prevaricator from Deceptionville. Nature had built him for a literary genius, but a rudimentary education jammed his cogs; so, instead of committing his dreams to paper and taking the print line to fame, he became a mere vocal hot air jammer, without honor in his own community and habitually without the price.

Concerning the usual affairs of life he was as truthful as the average; that is, whenever he found a lie convenient, expedient or necessary he told it circumspectly and discreetly. His voluntary efforts at misrepresentation were confined to stories of hunting scrapes and tales of his own fearlessness. That was his specialty; and, when pursuing it, he wore the probable to a frazzle and was a systematic, elaborate and enthusiastic liar.

About 1885 there were more brindle wolves to the square mile in Oscoda county, Michigan, than on any other like area exposed to the weather. From sunset to sunrise, especially in the fall, the night was one long, hair-raising horror. The brutes nearly drove the deer out, sheep were a losing investment for the settlers, tree-roosting poultry never attained pot-pie maturity, and many a good hound fell a victim to his wild brethren. More than one lonely land-looker and belated hunter disappeared in the dead of winter to be found the next spring, a mere heap of gnawed bones and shredded rags.

Windy came up one fall with a party of hunters. They were met at Beaver lake by a settler who drove them across the pine barrens to the Ausable where they were to camp. It was Windy's first hunt in the wilderness, and his companions conspired with the settler to the end that the vital machinery of a defunct hog and a little bag of asafetida were tied by a long string to the reach of the wagon when they halted, at sundown, at Loon lake, to water the team.

Windy was in his finest mood. He sat between the rear wheels on the grub box, his hat cocked up behind and pulled rakishly over his eyes. He absorbed quantities of red pepper whiskey. He took pot shots at squirrels and porkies and yearned for something less tame to transpire. In the course of things, it did.

Away off to the right, a mile or more, a wail as of a lost soul shuddered over the landscape. Hank Root grabbed the settler by the arm and demanded, in the name of an extra geographical locality, to know

what cussed thing was yowling. Windy butted in and said that it was only a measly wolf amusing himself. Back toward Loon lake the stillness was convulsed by a hideously blended reply. The settler glanced uneasily along the back track and urged his team. The wheels chucked on their worn skeins, the sand screamed softly off the tires and the men glanced sharply into the closing darkness. There is a great loneliness of long standing investing those Northern wastes. The plaintive cry of a melancholy fox came to the men with a softened distinctness which seemed somehow to fit into the rest of the big lonesomeness. The narrow surrounding horizon, enclosing squat little pines and discouraged scrub oaks, seemed capable of peculiar atrocities.

These men, with the exception of Windy, had hunted this country for many falls and, to them, objects and sounds would soon slip into their rightful places; but that night guns were held in hand, nerves tingled and the long dormant alertness of a savage ancestry manifested itself in gleaming eyes, and quick, shifty movements. Howling ringed them in. It came from every point of the compass, but oftenest and most fiercely from the rear. A rabbit sprang from a bunch of dried grass, making racket out of all proportion to his size and importance; the men rose as one and stood leaning and peering. They conversed in laconic gutturals. The driver pulled his team up, and taking 2 lanterns from beneath the seat, hung one on each horse's hame.

"Don't s'pose ther's any danger of 'em tacklin' us at this time o' year, but I ain't takin' no chances," he said, as he climbed back in. He swung the lash and drove on. "Feller used to drive tote team fer Loud's 2 years ago, wus comin' in on runners with a load of beef fer the camps. He allus carried a light on the end board, one on each side o' the seat and one on each hoss; but he forgot to fill 'em an' they went out on him jest as he got along by Lost crick. The wolves lit on to him an' killed him an' the hosses, an' chawed things up gen'ly. Course that was in the dead of winter, but —g'long thar; git out o' here!"

"Well, they'r follerin' us, all right;" said one of the party. Windy moved up where there was more company. Judging by the sound there were anyway 7 to 17 wolves snuffing at the scent between the wheel tracks behind them. They were so close that the undertone of protest at be-

ing jostled and snapped at could be plainly heard. The infernally cruel howling was incessant.

When they reached Damon, Windy complained of feeling sick. He laid it to the whiskey. When they crossed the county line and the pack had again picked up the scent after swinging wide of the settlement, he lay down in the bottom of the wagon, explaining that he felt as if he would heave up his boots. He frequently assured the others, however, that there was no danger.

"Don't you s'pose you'd feel better to git out and walk a little, Windy?" asked Hank Root compassionately.

"Naw, I'll be all right after a spell;" replied Windy.

The hills and gully thickets South of Big Creek swamp were wolf headquarters in those days. When the team wound in among them with the winking lanterns, they were greeted by a large and demonstrative mob which kept always at an indistinct distance, swirling like phantoms, threatening, taunting, playing Indian tricks of fiendish humor.

"Helofa tight job gittin' through that swamp," said the settler as he cracked the blacksnake over the wheezing horses. "You fellers had better git lined up where you kin do the most good in case they try to pull the hosses down."

Every body fired and yelled. They ploughed down the last sandy hill and crashed through the narrow rift in the cedars with the horses on the dead run. The pursuing pack took grand stand seats at the entrance and screeched bloody terror after them. There was another settlement within a mile, and Windy said he felt quite a lot better. He said the bumping over the crossway had kind of shook the sickness all out of him.

"Aw, hell! Sick yer grannie!" sneered Hank. "You're skairt; that's all's the matter with you!"

Windy ridiculed the idea.

"Why didn't you git out 'n kick a few of 'em in the ribs then?" Hank demanded.

"He dassent git out of the wagon now," taunted another; "an' ther ain't a wolf this side the swamp."

Windy hesitated, then jumped out and ran along beside the team.

"Git out into the brush, why don't you?" they yelled at him. He veered off and skulked along through the widely scattered trees.

There were 2 hounds in the wagon, and Hank put a painful kink in the tail of one, while Bob Stevens operated on the other. Charley Arand and the settler tucked the stocks of their Winchesters beneath their arms and worked the levers for dear life. All yelled at the top of their voices. The horses broke into a mad gallop.

"Git into a tree, fer Gawd's sake, Windy!" roared Hank; "they'r tryin' to climb the wagon." Windy shed his rifle, then his coat, and lit indiscriminately into the side of the most promising jack pine. The ki-yi-ing, shooting, cursing load went reeling around a crook in the road and pulled up breathless at the settlement. Windy roosted all right in that ridiculously inadequate tree.

When they came out in the morning to rescue him he slid sheepishly out of the branches and said:

"That's all right. I'm one of the damndest liars on Gawd's footstool; but if you fellers 'll promise not to say anything about this when we git home, I'll swear off right now an' do all the cookin' while we're here."

They all swore never to tell, and, from that time, Windy was a changed man.

Phrenologist—Here is a man out of his proper sphere. His head betokens high intellectual and spiritual qualities, yet he is spending his time behind a grocer's counter. Sir (to the grocer), I wish to ask you a question. Have you any aspirations—

Grocer (calling to clerk)—John, have we any aspirations?

Clerk—All out, sir. Have some in the last of the week.—Kansas City Journal.

FISHING AFTER DARK.

MAY MC HENRY.

There are several kinds of cowards, but if Uncle Elias was a coward, of which I have never felt sure, he belonged in a class of his own; in that, as in everything else, he was utterly and entirely original. He used to say that not to be afraid of the dark was to lack imagination. No one ever accused Uncle Elias of lacking imagination. It was because of his generous endowment of this ability that when he went fishing for trout in the dusk of the evening, he always took Aunt Sally Ann along.

Aunt Sally Ann's daughters, married and important, protested that it was bad for their mother's rheumatism, and that it did not seem proper for an elderly lady to be wandering along the creek at night. Aunt Sally Ann smiled calmly at the protests. She liked to be taken along; it made her feel young, or rather it reminded her of her youth to be out under the dim sky of night; it reminded her of her youth to walk home across the firefly-bedecked meadows and down the straggling village street, with Uncle Elias, because of that imagination of his, keeping very near to her.

On account of the tanneries and the big sawmills and the lumbermen who strip the mountains of their forests, Fishing creek bids fair to have only an Irish reason for its name. A few years ago there were plenty of fish. In the lower reaches of the stream in deep, shaded pools, there were big trout, wise, reserved old aristocrats that were not for the common angler, not for any one, in fact, but the initiated.

"Brother Elias, what kind of bait do you use that makes you so successful a catcher of fish?" the Methodist preacher asked.

"The kind of bait, Parson, that might make you a successful fisher of men—understanding and sympathy," Uncle Elias replied.

It was in the balmy dusk of a June evening that Uncle Elias caught his big trout. Last summer at the close of a sultry day Uncle Elias and Aunt Sally Ann went up to Swartwout's dam with the fish basket, the birch pole and the little bag of grasshoppers. A New Yorker who edits a paper about hunting and fishing and things was getting out of the stage in front of Boyd's hotel. He laughed as he saw the chubby old sportsman with the big fish basket strapped over the long and ample linen duster, little knowing that he would soon be begging that same hayseed fisherman to teach a New York expert how to catch trout.

Swartwout's dam is the spookiest place along the creek. It is in something of a

pocket at an angle of the steep, hemlock-covered hills, and only the sun at midday and a few ambitious stars climb high enough to look down into the deep, dark pool. On one side there is a row of dead sycamores, gaunt, naked, white as chalk, like a procession of stark ghosts knee deep in the water. Back of the trees is a swamp, where the fox-fire glows and jack-o'-lanterns flicker when it is dark. The big trout linger there at the base of the hill where springs bubble between rocks.

Aunt Sally Ann sat on a log near the dead sycamores. Uncle Elias tied the tails of his linen duster about his Santa Claus stomach and waded in his high rubber boots across the broken comb of the old dam. There is a narrow, slippery ledge of rock at the bottom of the hill. Uncle Elias stepped silently, carefully; no abrupt moves, no rattling stones to jar the nerves of those serene big fellows down below. He threw out a grasshopper or 2 to test the temper and appetite of the fish. They took food eagerly. There was no hurry; infinite patience, infinite care in selecting and arranging the bait. After a wait meant to pique the curiosity of the fish, the grasshopper at the end of the line sailed out to exactly the right spot, dropped lightly, and almost before it touched the water was seized with a swish and a rush. The thrill passed through the birch pole to every fiber of Uncle Elias' being.

The trout bit well that evening. When Uncle Elias had as many fish as he needed for immediate use it was his custom to stop, as he deprecated greediness; but up in the little eddy beyond the pile of driftwood a trout turned a somersault for sheer joy and deviltry. No angler could resist the invitation of that mighty splash, that gleam of big white belly. "He's an old residenter," Uncle Elias commented as he climbed over the driftwood.

The old residenter was coy. Uncle Elias tried all his tricks and wiles, his choicest bait, his most practiced throws. In the absorption of the true sportsman he took no note of time. The roll of distant thunder aroused him. Darkness had closed in swiftly; the outlines of the opposite shore were lost and the tall sycamore ghosts seemed to be wading across toward him. A sinister silence hung over the black pool.

"Sally Ann! Sally Ann!" Uncle Elias raised his voice to his faithful wife. There was no answer. The roots of his hair turned cold.

"Sa-a-lly! Sa-a-l-ly!"

There was not even an echo; nothing but

that awful stillness of the universe holding its breath in suspense.

"Wo-o-o-o-oo!" went a hoot owl on the hill. Souse! went Uncle Elias, 6 feet out into the middle of the deep hole. The water closed over his head and the spray sprinkled the tall hemlocks. The old residenter burrowed under a stone, where for 3 days and nights he did not venture to wave a fin. Uncle Elias rose to the surface and struck out for the shore. Snorting and blowing like a porpoise, he waded in under the dead sycamores.

There on her log he found the partner of his joys, his sorrows and his fishing, writhing in merriment, doubling in convulsions of unholy and unconjugal laughter.

"Woman! Woman!" sputtered Uncle Elias feelingly.

They went home at a little trot. Even in June the night air has a chill for one who has been drenched with spring water. Aunt Sally Ann tied her little shoulder cape over Uncle Elias' head that he might not take ear ache. The attention was received in grim silence.

As they entered their gate in the light that shone through the big window of the post office across the way, Aunt Sally Ann stuffed her apron in her mouth. She was not quick enough. Uncle Elias heard the smothered sound and tore off the little shoulder cape.

"Woman," he said with dignity, as he untied the clinging duster, "woman, a few more such light minded pranks and I will be justified in applying for a legal separation."

HIS CHANGE OF VIEW.

CANDICE A. BRAMBLE.

There was a man in our town, and he was wondrous wise.

The things that man knew how to do would fill you with surprise.

He said his wife should be ashamed to talk of overwork;

She had scarce anything to do, and only wished to shirk.

'Twas men, he said, who toiled and moiled, from rise to set of sun;

Their wives just bustled round a bit and all their work was done.

One day this man, in pleasant mood, declared his wife should go

Upon a visit to a friend and stay a week or so.

And when she spoke about the work, he'd do it all, he said;

It wouldn't take a man all day to sweep and make a bed.

And so the wife went on her way and left her spouse alone;

The story of the next two days would melt a heart of stone.

He tried to wash the dishes first; oh, yes, he truly tried!

He burned his hand and spoiled his coat before the cups were dried.

To tell of all that followed then, would be, I think, unkind;

But long before the day had passed that wise man changed his mind.

And ere the second day went by, a weary, jaded man,

He sent this message to his wife: "Come home, soon as you can."

And when she came. Oh, me! Oh, my! What chaos met her sight!

Her tidy house was all upset and in a dreadful plight.

Her husband, wilted and unstrung, met her with visage grim,

And she—I think I'll have to skip the things, she said to him.

But now he never brags at all about his wisdom rare.

And says he thinks of toil and care a woman has her share.

Mother—What are you crying for, child?

"Johnny hurt me."

"How?"

"I was going to hit him with my fist, when he ducked his head and I struck the wall."—Exchange,

A PILFERING GRIZZLY.

FRANK R. GROVER.

John Gilbert, of Cooke City, Montana, is a bear hunter. In the fall of 1902 he introduced 2 Chicago lawyers to a family of 5 silvertips and a job lot of blacks and cinnamons. The lawyers, true to the instincts of their profession, carried home the hides of the whole silvertip family and of 2 or 3 of their black and brown cousins, and the feat was the talk of all Northern Wyoming. I heard of it in Chicago and engaged Mr. Gilbert to duplicate the job.

In the early part of September my friend, Carl Leopold, of Burlington, Iowa, and our 2 young sons, with Gilbert as guide, were camping in Yellowstone park, seeing the sights and waiting for the open season in Wyoming, September 15th. If all the true bear stories that have been told around camp fires in Yellowstone park could be put in a book, the readers would all agree that the author had lost the intellectual partition between memory and imagination. The reminiscences of our camp fires would make one chapter in such a book.

The evening of September 2d, 1903, we were camped in a canyon about 2 miles from the great falls of the Yellowstone, and the discussion of Bruin in all his aspects was the evening's entertainment; the ferocity of the grizzly, the shyness, slyness and swiftness of foot of the black bear, the docility of the Yellowstone-park-garbage-pile-hotel bear, the nonsense of the lying stories about bears coming into camp and stealing provisions, were all argued pro and con. Gilbert was a modest, unassuming man, and we were never annoyed by the usual guide tales of his own exploits; but on that occasion, we were much interested regarding a patriarch of the grizzly tribe, weighing some 800 pounds, which the season before, near the park line and but a few miles from our camp, had left about 6 inches square of his right front foot in one of Gilbert's traps. Gilbert's remark, "I'd like to get within 10 rods of him and I'd fix him," was given but passing notice at that time. Bedtime arrived and after a final look at the saddle and pack horses and a peering into the darkness in the direction of the coyote chorus that had been rehearsing all the evening on the mountain side, we were ready to crawl into the sleeping bags. Gilbert declared he had heard so much fiction that evening about camp-robbing bears that he and his son Clarence would sleep on the ground around the wagon and he "should like to see the bear that could climb over him and get the bacon out of that wagon."

About one to 2 o'clock a. m. I awoke twice, aroused once by the clatter of a tin plate on the dinner table and again by the neighing of one of the horses.

"A bear in camp," I suggested, but I was lulled to sleep by some sarcastic references of Mr. L. regarding a similar midnight alarm a year before in a Michigan forest, when a common wood hare, or snowshoe rabbit, was found to be the intruder.

"Can't you hear Gilbert snore," said Leopold. "He is a bear hunter. Do you suppose a live bear would catch him with his eyes shut? Don't bother me."

What was known as the alarm clock in camp, namely Gilbert chopping wood for the breakfast fire, was usually heard at day-break or at latest 6.30 a. m. That morning the first sound was the exclamations of the Gilbert family, with intervals between devoted to investigation.

"The bacon is gone!" "The prunes are gone!" "Took the sugar!" "See his tracks!" "Say, he took that loaf of bread, too!" "He made 5 trips!" "And there I was snorin' like a tenderfoot!"

The investigation that ensued showed beyond question that Mr. Bear, with his velvet feet, had come softly into camp, stepped lightly over Gilbert and son and had committed 5 distinct burglaries, taking out of the wagon and the panniers and from our camp table, and carrying off in turn a sack of bacon, a bag of prunes, a loaf of bread, baked in camp for breakfast, 10 pounds of sugar and a yard or 2 of summer sausage. The few uneaten remnants of these supplies, found in a heap a few rods from camp, as well as the deep prints of Bruin's teeth in the sausage, which did not seem to suit his taste, would have convicted him of the robbery even before a Chicago jury; and the tracks plainly told us he was no dwarf.

This account of stock had just been completed when Gilbert began to examine with greater care the tracks which this ancient marauder had left behind. Both the tracks and the expression on Gilbert's face, to say nothing of his exclamations, indicated that he had found an old acquaintance, for about $\frac{1}{4}$ of the tracks were made by a club foot that would just make good that part of a bear which Gilbert's trap failed to hold the year before. Someone was unkind enough to remark:

"Say, Gilbert! did you get within 10 rods of him?" To which our pilot replied:

"No, but that durned bear got within 10 inches of me."

FROM THE GAME FIELDS.

The man who quits when he gets enough, with plenty of game still in sight, is a real sportsman.

COL. DUNN'S TRIP TO TIA JUANA.

Colonel Dunn, of San Bernardino, has returned from a hunting trip at Tia Juana. The trip lasted 3 days and there were 5 in the party. The Times-Index assures its readers that "in that short time they killed 2,480 quails, 150 doves and 100 cottontails, and made meat a drug on the market among the Mexicans and cholos. As a result of their liberality the village meat market closed during their stay. It was all wing shooting, too, barring the cottontails.—San Diego (Cal.) Union.

I wrote to Mr. F. W. Dunn, as follows:

I am informed you and 4 friends recently killed 2,480 quails in 3 days. Will you kindly let me know if this report is correct, giving full particulars.

Here is his answer in part:

Your inquiry I will answer as intelligently as possible. The shooters in the party were Mr. and Mrs. S. H. Black, Messrs. D. P. Doke, Fred Doke, E. A. Fano, George Garretson and I. With us, but not shooting, were Mrs. Garretson, the 2 Mrs. Dokes and Mrs. Fano. There were 7 shooters the first day and 5 the other 2 days, Fred Doke and Mr. Fano and their wives having to return to San Diego. The result of the first day's shoot was 824 quails, 165 doves and 42 rabbits. The other 2 days filled out the gross bag of 2,480 quails, 423 doves and 192 rabbits.

I am aware you want the information in order to roast us as game hogs. Being conversant with all the conditions from New York to California and from Washington to Florida, I have some conception of the justice of your efforts.

No man is more of a gentleman than any one of the several in our party and none would go farther to uphold the laws; but there are places where even law is in error as to game seasons. Still our party assists in upholding them.

T. A. Brown, of Mañvel, Calif., S. H. Black and I took another trip into Mexico 2 weeks after the one above mentioned, partly to shoot and partly to examine a gold mine. We shot the first day, bagging 418 quails, 65 doves and 18 rabbits. The next day we drove 20 miles, looked over the mine and left that camp to go back to Tia Juana Hotel, 30 miles. We carried to the hotel on our return trip 402 quails, 31 doves and 19 rabbits. Now don't think this is pot shooting. There was scarcely a chance in a day when we could get a pot shot on the ground. California quails flush easily and they run light, to high brush. A covey scatters in all directions, and it is single bird flight shooting entirely,

the birds resembling more the jack snipe than the Eastern quail in flight; so it is no pot hunter that can make a bag, and no common cold blooded dog that has nose enough to point. The country on both sides of the line is a rugged one, covered with brush.

All our game was given away to poor people in Tia Juana, where the butcher was charging 60 cents a pound for beef. We have made an eternal enemy of the butcher, as we threw the game out on the porch and told everyone to help himself. You should have seen the little half-clad urchins taking away as many quails as their hands would hold. In 5 minutes there was not a head of game in sight.

Being 54 years old and having shot thousands of head of game in nearly every State, and spent 30 years helping hew out the American frontier I believe I am not really required to apologize to any one on this subject and shall not do so.

F. W. Dunn, San Diego, Cal.

Mr. Dunn writes a 9 page letter, all of which I should have been glad to print if I could spare the room for it, as it is really interesting. It will be noticed that Mr. Dunn says in conclusion he will not apologize for his act, yet at least 7 pages of his letter are devoted to making what could only be properly termed an apology for this reckless killing. He undertakes to show that the poor little quail of Mexico is a pest to the ranchmen and fruit growers of that country, and not only a pest but a pestilence as serious and as destructive in its nature as the grasshopper ever was in Kansas, and he classes himself and friends as philanthropists who went down to Mexico and helped clean out the quails purely in the interest of the aforesaid ranchmen and fruit growers. He says in effect that he and 's companions deserve the gratitude of the people whom they benefited, as much as any grasshopper fighters ever deserved the gratitude of Kansas farmers. He recounts to me as he did to the newspaper reporter the fact that the quails were given to the starving, suffering inhabitants of Tia Juana and tells how these people thanked the donors with tearful eyes for the strings of birds which they carried away. Mr. Dunn furthermore says that he and his party incurred the everlasting hatred of the butcher in that town, who was unable to sell any meat for a week after each of the 2 visits made by these quail butchers.

If this story was new, it might have mitigated the offenses of these quail butch-

ers to some extent, but unfortunately it is not. Men who have killed wagon loads of geese in California and ducks in Oregon and deer in other States have, when called to account for their wickedness, put up the plea that they gave the game away to poor half starved babes in infant hospitals, or to lung sufferers in other hospitals, or to some other charitable institutions. It is a mystery to me that the so called cloak of charity has not been torn into shreds long ago by being stretched to cover the crimes of so many thousands of game butchers. Mr. Dunn and his friends may be charitable men, but I would bet 10 to 1 that if any man asked them to go down to Mexico and kill 1,000 or 2,000 birds to feed the suffering children of any town there, the aforesaid hunters would decline the invitation with thanks. Still, these same men go down there, kill 2,480 quails in 3 days and then in order to try to square themselves with their consciences and with possible accusers at home, distribute their birds among these poor people; but it does not go. No decent man will be hoodwinked into forgiving them for such disgraceful slaughter, simply because they could not eat all these birds and because, therefore, they gave them away.

It was simply the love of slaughter and the vanity these men felt in being able to make great records, that prompted this merciless destruction of bird life.

Here is a copy of an entry I have just made in the game hog register.

F. W. Dunn, No. 972; S. H. Black, No. 973; D. P. Doke, No. 974; Fred Doke, No. 975; E. A. Fano, No. 976; Geo. Garretson, No. 977; T. A. Brown, No. 978.—
EDITOR.

SUGGESTIONS FOR QUAIL HUNTERS.

When you are ready to go quail shooting, drive around to the corner saloon and load up 2 or 3 kegs of beer, depending on the room you have in your conveyance. Ask all the loafers you run across to go with you. They will be useful for advertising purposes, if you like to advertise that way. They will also help to make noise, but do not put them in the end of the wagon containing the beer. Better take a bottle of bug juice, too, as the good old farmer may like it better than beer.

Take at least 300 loaded shells for each man, not forgetting the loafers. They are not men, of course, but will probably want to shoot. Don't buy anything smaller than No. 2 shot. The birds are wild these days, and have to be persuaded with heavy shot. Besides, with large shot you may be able to shoot the eyes out of a cow or a horse over in the next county.

As soon as you get clear of the police,

do as you damn please. Law and order are all right for the city, but everything goes in the country. Shoot at all the chickens you see, and sing and yell all you want to. Country people enjoy noise and riot.

When you arrive at the home of the farmer with whom you have made arrangements for dinner, drive into his yard and yell some more. This will please and impress the worthy agriculturist, and make him glad to entertain you. Then tumble out of your wagon. Of course, the farmer did not expect such a crowd, but never mind that. He may appear a trifle gruff, but pay no attention to him. He probably hasn't been up long, and feels cross and sleepy. His gruffness will wear off before noon.

Don't forget to turn your dogs loose as soon as you reach the barn. They can limber up on the poultry and stock while you are putting out your horses and getting the beer out of the wagon. This is good for the dogs, and they will be in shape to work as soon as the hunting grounds are reached. Pay no attention to the fuss made by the poultry; they will settle down in a week or two; those that are not killed.

When you get down to business, shoot. No matter what you see, shoot. It doesn't pay to take chances of losing game when you are hunting. No matter if you do kill a hog or a sheep. It might have been a rabbit, you know, and the more you shoot the more you may expect to kill. If you chance on a farmer gathering corn, go up close to him and fire 2 or 3 shots as fast as you can. He will not mind it. His horses may run away, but they will soon stop. If he asks you to go over on the other side of his farm, fearing you may shoot him, don't go. There is no use of it. Farmers must get over being so timid.

About an hour after you begin hunting, your loafers will want to go back and look after the beer keg. Let them go, and tell them to enjoy themselves. Tell them not to be afraid to make a noise around the farmhouse. The sight of a few well jagged bums will afford much amusement to the farmer's wife and her daughters. At noon come in and see how your partners are getting on. At this time interview the bug juice bottle. This will give you an appetite for dinner. Don't pay for your dinners if you can avoid it. See if the farmer won't accept 3 or 4 rabbits, those that are shot up the worst. Bird hunters generally bag plenty of rabbits, though in town they will tell you they never shoot at anything but birds. When hunting, always throw down all the fences you can. This gives the worthy farmer something to do the next day, and the work helps his

digestion. Leave all gates open, and do everything you can to show that you are at home on the farm. Many other pleasures besides those enumerated will suggest themselves to the thoughtful hunter, helping him to put in a glorious day afield. Finally, start for home about dark, and spend the next 3 days beguiling your town friends with stories about the uncouth hayseed and his amusing ways.

Farmer, Markleville, Ind.

SOME BEAR FACTS.

M. S. Whitney, of this place, visited his bear traps recently and found that one was gone. He took the trail, which led up under Tumbledown mountain and soon saw by the signs that he had a large bear to deal with. It was hard trailing among the rocks and ledges, and in the afternoon it rained. Whitney had to leave the trail and go home. The next day he enlisted the service of a neighbor and started again to look after his traps, as he had others set in that section. He soon found that another had been sprung and carried away, but could not find much sign. Both men went home and reported 2 bears in traps somewhere in Township number 6, Franklin county.

The next morning Mr. Whitney started with A. S. Yorm and his son, Clifton, with rifles in hand and lunch in their sack, determined that the bears must come down that day. About 9 a. m. they came to where one bear had taken a trap from his bed. After looking about carefully they struck the trail, but the showers of the previous week had blotted it some. They succeeded in trailing the bear about half a mile and found the trap with a bear's toe in it. They took the trap and started for the other trail. In about an hour they found where the bear was dragging another trap. We had no trouble in following him as his tracks showed he was no cub. In a short time we found fresh tracks and the word was passed along the line to be ready to drop the bear when they found him hitched up.

Clifton was ahead, with his rifle in hand, the others following up the side of the mountain. Suddenly up sprang the bear from behind a rock. Clifton gave him one from his 44, Whitney came in with his 44 and Add with his 45-70 Sharps. All were snap shots and the boys did not need any one to say shoot. Every time the bear showed himself among the rocks and trees a ball went for him. Did you ever see a black bear run? This bear did run, with trap and chain, which weighed about 40 pounds. Clifton took after him and the woods fairly rang with rifle shots and the jingle of the trap and chain. Whitney and Add followed as fast as they could. They

soon found that the bear was bleeding fast. The bushes and trees were spattered with blood, but on the party went. The bear ran along a crevice in the ledge where, if he had made a false step, he would have slid off 100 feet; but he ran it all right.

At the end of half an hour they heard Clifton shout. They answered him and followed the trail, picking up his hat and lunch bag, which they took along with them. They found him seated on a rock with the perspiration rolling off his face. He said the bear was too much for him on a long run and he could not get up to him. They then followed about half a mile farther and came to a little brook where they stopped to lunch, but the water smelt a little of bear tracks so they started on again.

That time the word was "keep still and make good time." They trailed him an hour and not a word was spoken. The bear had stopped running and was making a good trail to follow. They found another brook. Clifton stepped up stream to drink. Whitney and Young crossed the brook and as they reached the opposite side the water was roiled. A few more long strides and the bear was sighted. Then there was some sharp shooting. Six shots were fired and all took effect. The bear ran into the brook and stretched out.

He was a big one and would have weighed 400 or 500 pounds. Out of the 14 shots fired 10 had taken effect. The chain had been broken and the clog was gone; the pan and crossbar were off the trap.

The men were 10 miles from home but they took off the pelt and one of the fore-paws, knocked out 2 of the tusks and left the bear to his haunts, to go back to dust. His skin is on Whitney's barn. It stretched in length 7½ feet and 6½ feet from arm to arm, without his gloves on.

A. S. Young, Byron, Me.

THE DUCK HOGS OF PORTLAND.

If the L. A. S. has a representative at Portland, Ore., it might be well to investigate conditions reported by 2 business men of this city, recently returned from there. From their story and from information from other sources I infer that an extremely low standard of sportsmanship exists in Portland. The large and influential clubs, owning private shooting marshes, and having members supposedly representative of the latter element, seem to be the worst offenders.

One man here says he was recently invited to the marshes of one of the big clubs in Portland and gladly accepted. There were 7 or 8 present, including himself. Between 700 and 800 ducks were killed in the morning's shoot, of which 34

fell to his gun. He said he was heartily ashamed of his kill, but the others laughed at him for not getting more. When about to take his 34 ducks to distribute to friends, he was informed that no birds could be taken away, but that all must go to the Portland market and be sold for the benefit of the club treasury. Upon expressing mild surprise, he was told that this is the common practice of all the clubs in Portland, and on investigation, found it true.

I have since talked with a man who travels for a large gun house and who would not wish to be quoted by name. He confirmed the report that such conditions exist in Portland and, to some extent in Seattle also.

I confess I have not been guiltless myself in years gone by, but since reading RECREATION, and especially since joining the L. A. S. several years ago, I am content with the legal limit or with less. I think any community should be shown up that permits wholesale slaughter of game by clubs of so-called sportsmen, which, if done by a market hunter, would doubtless land him in jail and would be called a crime.

P. D. W., Spokane, Wash.

There are 2 cities on this continent that are especially notorious for the large number of game hogs who root in their streets. These are Denver and Portland, and while there are many respectable sportsmen in both places, the bristleback element is so largely predominant that it would really be a blessing to the game protective interests of the country at large if both cities should be swallowed up by earthquakes. You should not mention the members of the Portland ducking clubs as sportsmen. By so doing you degrade the term. A gang of men who will club together and kill ducks at the rate of 100 a day each, and then sell them, are beneath the notice of any true sportsman, and your friend who associated with these men for one day should be ashamed of the fact as long as he lives. I have been invited to shoot with these dirty loafers at Portland, but I would rather go into a genuine hog corral, anywhere, and eat shucks with the 4 footed beasts than be found in the club house with such disreputable and disgraceful 2 legged brutes as these who comprise the Portland club you tell about.—EDITOR.

SPORT OR MEAT?

There is no question as to whether or not game should be protected; the question is, for what purpose? In days gone by we were taught that game was created for table use. If that be true, then I favor still hunting of deer and ground shooting of birds, in order that we may secure the most meat with the least labor. Killing an

animal for meat is only butchering; and when we want to kill a beef do we put dogs after it in order to make the task longer and more exciting? When we want a fowl for dinner do we scare it to make it fly?

Some readers on seeing this may say I am not a sportsman and can not feel the thrill of triumph that a successful shot brings to the hunter. If they call still hunting deer or ground shooting birds sport, then I am not a sportsman. I have killed but 2 deer in my life, and only for their meat. I still hunted both, and there was no more sport about it than about butchering a beef.

It seems to me that game was created to furnish sport as well as meat, and in that belief I heartily endorse the article by J. D. Morley in July RECREATION. I am not so tender hearted as Mr. Morley, and might hunt another deer if I needed his flesh, but will never still hunt one for sport. Mr. Rodney West, with many other anti-hounding men, contends that one can kill more deer by still hunting than with hounds; as if the quantity of venison secured was the only object in view. If he is right, hounding should be a measure of protection to the deer. If he is wrong, it will still be instructive to compare the 2 methods.

The still hunter noiselessly treads the forest until, warned by the cracking of twigs that he is in the vicinity of game, he hides to wait for a shot. Presently a deer comes in sight. The hunter pulls trigger and his mania to kill is, for the moment, gratified. The rest of his experience is labor. What little sport there was he enjoyed alone and it lasted but a moment.

The hounding man, having learned where a deer is ranging, invites a number of friends to share the sport and enjoy the music of the chase. A dozen hounds sweep over the trail, a dozen steeds pull furiously on their bits and as many human hearts beat gayly, relieved for the present of all worldly care. The chase continues for miles and hours until the deer is bayed and killed. Then the hunters share the venison as they have shared the sport.

The still hunter has a whole carcass hanging in his smokehouse and if he wanted only meat, is doubtless satisfied. The hounded deer yields as much meat and, in addition, furnished a day's recreation to a whole neighborhood.

I should like to hear from more RECREATION readers in regard to what our wild game is for.

H. S. Ferrell, Weiser, Idaho.

AFFAIRS IN THE TETON RESERVE.

Having been a guide and trapper on the Teton forest preserve in Wyoming since

'96, I am able to give a fairly accurate account of the conditions obtaining here since the establishment of the reserve.

Interest in game protection has increased yearly until we now have a well organized force of deputy wardens patrolling the hunting grounds and rigidly enforcing the law; but the question of a winter range for game remains to be settled. In extending the reserve last spring, withdrawing from settlement a large area of land, it was the intention to provide safe and sufficient winter range for the different kinds of game. Yet in all the country reserved there is no locality in which a large herd of elk can safely winter.

Old hunters remember that in the winter of '88, when there were only 2 or 3 ranches and not a fence post in Jackson's Hole, elk had free access to all the range, including the large swamps where slough grass grows tall and rank. The crusting of the heavy fall of snow that winter prevented the elk from pawing down to the grass and thousands perished from hunger. Should there come another such winter, now that the winter range is grazed all summer by cattle and the large swamps have been fenced, it would result in the death of all elk in the reserve. The attention of all advocates of game protection seems to have been fixed on the country South of Yellowstone park; but for winter range one township the width of the park on the North boundary would be worth the whole Teton reserve.

In the discussion of protection of wild animals there must arise the question of the rights of another animal called man.

Before the setting aside of the original reserve there had come into the country a considerable number of settlers, some of whom squatted on unsurveyed land with the intention of building homes. In '98 the reserve was finally withdrawn from settlement with the land still unsurveyed and the squatters without filed claims. Some have homes and barns, and farms fenced and ditched. To take from these people their hard earned property seems extremely unjust and contrary to the intention of the government.

The many inspectors and supervisors who have been sent to report on the condition of land, timber, game and people in this country have been too much influenced by their desire to retain their jobs. They have seized on every pretext to justify to their superiors the wronging of the settlers on the reserve.

I have a personal interest in this matter, and, facing the loss of lands and buildings that have been my home for years, I can not restrain a feeling of bitterness against those directly responsible for this state of affairs. Albert Collins, Moran, Wyo.

AN ADIRONDACK EPISODE.

J. W. FURNSIDE.

When John and I decided on a hunt in the Adirondacks, we wrote Bill, the guide, that if his services could be obtained he would see us November 8th. On receiving a favorable reply we looked the 2 Savages over, and spent our spare time in getting things ready. This was John's first trip after deer and although I had hunted 3 different seasons fortune had never favored me with a shot at a deer.

Arrived at S— we met Bill, who gave us a hearty welcome. After purchasing our provisions we retired in order to get an early start for camp in the morning. Sunday morning broke clear and cold. Everything was covered with a mantle of white frost as we started with our packs for Bill's camp, 9 miles up the Conganinck. At camp we found that all people who live in the woods are honest. Bill had left a bushel of potatoes and some other provisions there. Someone had used the camp; also the potatoes.

Monday morning Bill cooked flapjacks, for camping without flapjacks is out of the question. The way we waded into them rather surprised Bill. After breakfast we set out. Coming to a good location Bill said he and John would get on the runways while I beat out that piece of woods. I drove out a doe and a fawn. John saw them, but did not get a shot. We then separated and while going over a knoll I heard a deer bleat. I was cautiously working my way toward the top of the knoll when I heard the deer, and swinging around I sent a shot after him as he disappeared about 150 yards away. Bill saw 2 or 3 deer that day and shot at one, but missed. We traveled until we were so tired we could hardly walk, and we did not get in until after dark.

Next morning John's feet were so sore that we promptly named him Tenderfoot. On his account we took only a short hunt. We saw one deer but did not get a shot. Wednesday Bill shot a large buck. That deer was 5 miles from camp and we wanted to get him out without cutting him up. He weighed nearly 200 pounds, and there was no road by which to get him out. We dressed him, and, fastening a rope to his head, pulled him in the direction of camp. Going down hill he slid along all right, but it wasn't all down hill and then he didn't slide so easy.

It took us that afternoon, all the next day and the forenoon after to get the deer to a place where we could drive in and get him. John and I were tired, and Bill,— but you can't tire those guides. Yet Bill said it was hard work. It is the kind, however, that makes a man want to try it again at the first opportunity.

THE LAKE CHELAN REGION.

During the latter part of last June, while on a trip to the Northwest, I paid a short visit to Lake Chelan, Washington, and I advise all who may have the opportunity to do so to visit that interesting region. Few places that I know of offer so many attractions to the lover of nature or the seeker after health and recreation. The lake lies about 40 miles North of Wenatchee, and is reached by daily steamer on the Columbia river, or stage if preferred, from that point.

The lake is a beautiful sheet of remarkably clear, cold water, extending from near the Columbia river about 60 miles Northwest into the heart of the Cascade mountains, and averaging perhaps a mile and a half in width. Small steamers run to the head of the lake daily and the trip is most fascinating, the scenery becoming more grand and picturesque at each turn in its gently curving shores. At the head of the lake the mountains rise from the water's edge to 7,000 or 8,000 feet. There are beautiful waterfalls and large glaciers in the mountains. Horseshoe basin, about 24 miles above the head of the lake, in the main range of the Cascades, is said to rival Yosemite in grandeur.

There was still much snow on the mountains the last of June. Deer, bear, goats and grouse comprise the principal species of game, and trout of 2 or 3 species abound in all the streams and in the lake. A State fish hatchery is now being located at the head of the lake to keep it and adjacent waters stocked, and the mountains are in a government forest reserve, so the region bids fair to be an attractive one to the tourist and sportsman for a long time to come. To one interested in natural history and geology, or fond of camp life and mountain climbing, there is no more desirable place. The elevation is moderate, the lake being about 1,000 feet above sea level and the climate in consequence is mild and pleasant throughout the greater part of the year, the long summers being delightful, with dry, pure and bracing mountain air, and nights always cool enough to sleep in comfort. The foot hills and open country around the foot of the lake are a paradise for the fruit grower, and are beginning to be utilized for that purpose, so berries, cherries, peaches, apples, etc., can be obtained in abundance in season.

S. E. F., Chicago, Ill.

A VETERAN MOOSE HUNTER.

I received your letter regarding the recently published statement that I have killed a moose every year for 53 years, and in some seasons as many as 5 or 6. The ac-

count was written by my friend, George Leaman, who doubtless thought he was doing me a favor.

From 1850 to 1870, when I was a young man and there was no game law, I, as well as my neighbors, hunted moose with dogs when the snow was deep and hard. Some seasons I got 4 to 6, and in the spring of '56 I helped kill 9. About that time I became disgusted with hounding, and was one of the first to demand a game law. Such a law was passed in '74, making a close season for 3 years. The Province was divided into 6 game districts, each having a commissioner, and, to my surprise, I was appointed commissioner for District No. 1, comprising the 5 Western counties. I have held the office ever since, and my last annual report was the 29th I have written. Under the working of the law moose have rapidly increased.

Since the passage of the law, my hunting has been confined to calling and still hunting. During the last 5 years I have called 6 moose, getting all but one the first morning on the ground. I can not say how many I have killed altogether, probably nearly 100. I have been fortunate in living in a game country and in being able to hunt throughout a long life. If I have killed many moose, I have worked hard to protect them, and the game of the Province has no better friend than I.

W. S. Crooker, S. Brookfield, N. S.

WOULD NOT DO IT NOW.

Your esteemed favor in which you ask me to tell you if the report is true that 5 friends and I recently killed over 1,000 birds in less than a day and a half, is received. I am sorry you have been misled in the way I see you have. The facts of the case are these: One of our daily papers is publishing each morning a number of extracts from its local pages of 20 years ago, entitling it "Twenty Years Ago Today." In October, 1883, 5 friends and I killed, in a day and a half, at Long lake, North of Letcher, about 8 miles West of here, nearly 1,500 ducks, and brought nearly 1,000 of them here to Sioux Falls and distributed them. During the years after the great flood of '80, this whole country was practically alive with wild fowl, and it was no trick at all to shoot until one absolutely got tired. This item has evidently been circulated without regard to the time it referred to. There was then no limit on the number of birds that could be killed, and practically no game law.

I do not wonder at your being startled, and no one condemns such slaughter as this more than I do at present. However, it has given me the pleasure of receiving

a letter from you; and like many other youthful follies, it happened so long ago, that I can only smile at it.

C. H. Wincor, Sioux Falls, S. D.

GAME NOTES.

There is usually plenty of game here and in Indian Territory, only 4 miles South; there are also plenty of hunters, game hogs, and fellows who hunt game out of season. The latter are already at work, a month before the open season. How can this be stopped? We have no game warden. Quails are more plentiful than for several years, and lots of them are not half grown yet. Ducks are beginning to come in fast, mostly blue wing teal, with a few pintails and mallards. They no more than alight before there is a volley fired into them by fellows who do nothing but hunt for the market. We have a few jack snipe and rail, but they do not stay long. I like RECREATION better than any other magazine. I wish you could put the hogs in a real pen; then there would be some chance for the sportsman who is a gentleman.

J. L. Hitchcock, Coffeyville, Kan.

I read with disgust the letter, in October RECREATION, from the 3 shoats of Ashland, Oregon—Casey, Hogan and Dunn—who “shot 193 ducks in 5 hours; mostly big ducks.” The game law of their State says: “It shall be unlawful for any person to kill more than 100 of the herein-before enumerated ducks in one week, or more than 50 in any one day.” Looks to me like a case for the warden, if they have any in Oregon. Anyway, I’ll bet the bristles on that trio are so stiff you could stick them through an oak plank.

G. S. Edmunds, Waterville, Me.

I am much interested in RECREATION, and am glad to see the vigor with which you roast the game hog. We have our share of them here; perhaps more of them than the East, as this is a new country where game abounds. In spite of the hogs, large game is on the increase. The Mongolian pheasant does not gain ground and grouse are giving way, but deer, elk, bear and trout are on the increase, in spite of the dirty work carried on in some localities. I hope game protection may be firmly established here before it is too late.

Elbert Watt, Salem, Ore.

A friend said he knew where the woods were full of grouse and that they were so saucy they would make faces at us as we passed; so this friend and I drove out there, accompanied by my English setter, Dick. We managed to find 2 grouse just

before it got dark. One was dropped by that Syracuse you gave me last January. The other is still going. Dick found him 3 times for my friend, but somehow his gun was stubborn. Dick is now interviewing the bones of the grouse I killed.

L. N. Van Duzer, Grand Haven, Mich.

Is there any authentic case on record of finding bull moose dead with locked horns? I did not suppose it to be possible and never heard of it before, but such a case now exists. The moose were found near our camp, soon after the tragedy had been enacted and the moose were still warm. This may be a common occurrence, but is new to me and none of our party had ever heard of such a thing.

H. A. Morgan, Albert Lea, Minn.

Does any reader of RECREATION know of such a case?—EDITOR.

We have excellent duck, goose and chicken shooting here, also some game hogs, though not so many as one would expect in a country where small game is so plentiful. I use a lever action pump gun, and probably always shall, but I know enough to quit with a decent bag. A pump gun will not make a hog of a gentleman any more than a double or single gun will make a gentleman of a game hog.

M. C. Johnston, M. D., Hope, N. D.

Our duck and goose shooting was excellent last fall. Our flights of ducks and geese grow larger every year. The marshes are full of mallards and geese about 6 weeks in the fall.

Norman Miller, Virden, Man.

We have many game and fish hogs around here. I was one myself before I read RECREATION. They need the L. A. S. to pull their bristles.

G. F. Whitmore, Martinsburg, W. Va.

Grouse were plentiful here last fall, but they were wild and few were killed. I wish you success in your war against the game hog.

Lyman Brooks, Charlestown, N. H.

Does any reader of RECREATION know a good way to trap sparrows? If so, will he kindly describe same for the benefit of RECREATION readers?—EDITOR.

Quails are abundant here, also rabbits and ground squirrels. I understand that deer are plentiful back in the hills.

E. A. Wright, Los Angeles, Cal.

FISH AND FISHING.

PICKEREL VERSUS SNAKE.

We had been fishing, with varied success, for some time, and were resting, when the still surface of the lake was broken by the appearance of a large water snake, its head raised about a foot above the water line.

"A regular Coney Island sea serpent!" said Charley, as he called my attention to it. We watched it a few moments as it moved swiftly toward a neighboring marsh. Suddenly there was a swirl, the water fairly boiled and the golden sides of a pickerel shone for an instant, then disappeared, together with his snakeship.

While we were wondering at the occurrence, the snake again came to the surface and started frantically shoreward. Again the water lashed into fury. This time Mr. Pickerel missed and the snake seemed to redouble his efforts; but it was only a momentary respite, and the snake was again in the jaws of his foe. He shot out his forked tongue and struck viciously at his captor.

A second disappearance and that time the water snake, minus half his length came to view and struggled feebly. Then, like a crowd of human vampires who watch for a victim in distress, a school of small perch attacked the mangled remains and pulled them hither and thither.

"Guess those fellows have formed a trust," said Charley.

The foregoing is just another example of the voraciousness of the pickerel, of which every desciple of the rod is fully aware. The snake was over 4 feet in length while the fish would probably have weighed 4 pounds. The instinct of self preservation told us to go home before his lordship tackled the boat, and we did.

Gorden Wrighter, Kingston, N. Y.

On receipt of the foregoing I wrote Mr. Wrighter as follows:

Do you really mean your snake story is true, or are you only jollyng the other fellows? It sounds straight enough up to the point where you say the pickerel bit the snake in 2. Even that part of it might be true, but I scarcely believe a small pickerel could bite a 4 foot snake in 2. His teeth are not set for cutting. They straggle about in his mouth, and scarcely any 2 of them come together so they could cut.

We often hear stories of pickerel cutting a snell or a line as if it had been cut with a knife, but that is all rot. The fish breaks the snell or line, but does not cut it.

The second part of your story, about the perch attacking the front half of the snake, would also be questioned, and even ridiculed by many people. It might be true,

but I should like to know more about it before printing. Will you kindly tell me the full name and address of your friend who was in the boat with you?

Here is his reply to my letter:

I do not blame you for questioning the veracity of my fish-snake story as I was fully aware when I sent it in, that it would be generally doubted. I have been a constant reader of RECREATION since its early issues, and appreciate the fact that its object is not to fill its pages with any Jules Verne flights of imagination. The story is positively true and I am willing to make a sworn statement to that effect. The man in the boat with me was Chas. L. Wrighter, of Thompson, Pa., a brother of mine, and as this is all in the family I request you to write the postmaster or any well known business man of that place, if you see fit, as to the reputation we both bear for truthfulness. I have been a close student of fish and their habits and I sent the story just as an example of the voraciousness of the pickerel. Mind you I do not say the pickerel consumed the other half of the snake. As to that I do not know. I do know that the front half came to the surface and was immediately surrounded by an army of small perch.

I heartily endorse your care in investigating the truth of what you publish and wish all editors of sportsmen's publications were as careful.

Gordon Wrighter, Thompson, Pa.

RAILROADING A TROUT.

There is scarcely an angler in New Brunswick who does not know Mr. John Stewart, the genial and loquacious traveling freight agent of the Canadian Pacific railway. Mr. Stewart makes his home at Woodstock, and there is not a trout stream or a salmon pool between Temiscouata lake and the St. Croix river that he has not soundly whipped. He is without a doubt one of the most enthusiastic and successful anglers in Eastern Canada, which does not imply that he possesses any of the instincts of that unpleasant creature so often depicted in RECREATION, the fish hog.

Mr. Stewart's duties take him to different parts of the Province, and not long ago he was present at an informal meeting of the Fredericton Tourist Association, a wide awake organization composed of leading business men of the city, who do a great deal to assist American sportsmen and tourists. During the evening the conversation

turned to trout fishing, and one of the members told of having read somewhere how a trout had been kept 6 months in a tank of water as an experiment, and when taken out at the end of that period weighed exactly the same as when put into the tank. The remarkable thing about it was that the trout had not been fed during that time, and an analytical test showed that there was nothing in the water on which it could subsist.

Mr. Stewart was naturally much interested in the story and proceeded to tell of a remarkable experience of his own with a pet trout. Here is the story in his own words as nearly as I can remember them:

"I once kept a trout in captivity a whole year," said he, "and where, do you think? In the water tank of a locomotive! I think it was in the summer of 1869 that I caught the fish. I was then a conductor on the New Brunswick Railway. We had stopped near a standpipe one day to take water, and while the boys were loading the engine I dropped a line into a brook near and landed a trout, which I should judge weighed about half a pound. It was the only fish I caught at the time, and as the train was getting ready to pull out one of the crew jokingly suggested that I put my catch into the locomotive tank, so it would have a chance to grow. I was favorably impressed with the novel idea, and raising the cover dropped the fish into the water. You may not believe it, but the trout flourished and grew fat in that tank. It had a fresh supply of water at least half a dozen times a day, and during its 12 months in captivity it increased in weight from half a pound to 2½ pounds. We fished it out once in a while merely to see how it was getting along. It was always full of life and whenever the cover was removed from its prison it would come to the surface with a rush and play and splash about on top of the water. On one occasion it splashed water into the face of a new fireman, not on to the game, and almost frightened him out of his wits. The train hands took a great liking to the fish and frequently dropped food to it from their dinner pails. No doubt their kindness was to a large extent responsible for the trout's phenomenal growth.

"Well," said Mr. Stewart in conclusion, "the trout remained in the tank until something happened to the locomotive, which necessitated its being sent to the repair shop. The water was then drawn off, and one of the workmen, finding the trout, took it home and made a meal of it. During the trout's captivity the locomotive was nearly always in use, averaging perhaps 150 miles a day, so the trout must have traveled nearly 50,000 miles. R. P. A., Fredericton, N. B.

THE PERCH OF THE GREAT LAKES.

F. M. GREENLEAF.

I have read with much interest many able articles written in praise of that most hunted of God's wild creatures, the game fish, and it seems to me that something equally interesting could be said concerning the less combative habitants of the water.

Waukegan, Illinois, is a bustling little port on the shores of Lake Michigan. Although it now devotes most of its energies to manufacturing, in the days of old, when I regarded it as my own burgh, fishing was the chief industry. Well it might be, for the clean, pure water of old Michigan, cooled by breezes from the Northland, gave up healthy, firm fish such as we of the West seldom taste.

To rise at 4 in the cool mornings of a hot summer, to grope through the woodshed until your hand finally touched the old pole, to take the can of worms you dug the night before and scurry down the road to the lake, all this was pleasant indeed; for out at the end of the long pier were the perch.

A plain bamboo pole, big and long, 10 feet of strong white line, a sinker, a hook and a wriggling worm. That was all; no reel, no flies, no landing net. You picked out an especially inviting pile for a seat and quietly dropped your line into the dark green water. Then there was a tug, a jerk. You gave a mighty heave upward, and with a last, despairing, resisting pull, out he came!

A great lake perch! A big, clean fellow, with immaculate golden sides, a bristling array of fins, a beautiful silvery underside, and a firm feeling to the touch. Nothing dirty or slimy about him. He comes from the cold clear water of Lake Michigan. Below him is pure white sand, above him is God's own air and sky.

He breathes what we drink. He drinks what we breath. He is not "game" because it is his nature to be gentle, submissive. He lacks the defiant braggadocio of many of his brothers because of his personal character, not from the absence of strength or spirit.

Tell me, you Nimrod, is the trout or bass a daintier or more toothsome morsel than a fried perch? Is the trout prettier? Is the bass cleaner? You think because you are fighting that trout, that he has a fair chance for his life. Why, I'll bet I lose as many fish with my yellow pole off that old pile pier as you do with your blue hackle fly and automatic reel when pitted against the despairing struggle of a lithe, strong brook trout!

Here's to the great lake perch! I honor him, I respect him, I might say I love him. I am no fish hog, yet I have caught

a string of 40 in a morning, and the family ate them every one. It was right, too, for Providence provided them for our use.

If, indeed, "Cleanliness is next to godliness," I feel safe in saying there is a fish heaven somewhere ahead for my friend, the great lake perch.

HOW TO STRING FISH.

When we were boys we secured our fish by poking a string through the gills and out at the mouth; a process which finally ended the life of the little sufferers. There are thousands of anglers to-day who inflict the same prolonged agony on their captives. Some sever the vertebra just back of the head, some cut the throat, which, in both cases, makes a bloody mess. I have fished with comrades who stuffed their fish into a sack and kept them quiet by rolling them tight.

While all these methods are capable of producing death, they are not thoroughly satisfactory, because in many instances the angler is desirous of keeping his catch alive 3 or 4 days until his departure for home. Many, perhaps the majority of that class, push the stringer needle through both jaws and thus effectually close the mouth of the fish, which, they argue, keeps it from filling with water and drowning.

If the stringer is pushed only through the thin portion of the under jaw the fish is subjected to no pain, the jaw is sufficiently strong to hold the fish, and it can open and close its mouth naturally. When the boat is moved this natural action is interfered with, but artificial respiration is set up. Water flows in at the mouth and out through the gills and the fish breathes artificially. I have caught bass in the early part of the day, strung them through the lower jaw only, and they were as lively when the day's sport was over as the last ones caught. I have kept perch alive in the same way.

One great source of loss to the angler is the constant shuffling of feet on the bottom of the boat. Fish, as we all know, are wary, unless excited, when there is no rule governing their actions.

I once had a strike from a dogfish on a frog too large for him to swallow. Fancying that I knew what the fish was, I reeled him in cautiously, until he was directly under the boat. Partner and I had been canvassing the question of noise. During our conversation doggy was worrying at the frog, on the bottom in about 10 feet of water, which was so clear we could both see his every motion. Then I said, "If I am right, I will make my tackle-box lid snap, and he will skip." The box lay on the bottom, on the running board. The tinkle of the tin, so light as hardly to be heard at the bow of the boat, made him drop the

frog and dart away as if he had been shot at.

Folks who can't keep their feet still in a boat should either go barefoot or wear moccasins.

C. C. Haskins, Chicago, Ill.

IS THIS A RECORD BREAKER?

Last week Bellefonte claimed the record for big trout. This week Oleona disputes the claim. The Oleona fish was caught by Edward Bachman in Phelps pond, near Sand Spring brook, a tributary of the Lehigh river, near Thornhurst, Lackawanna county. The fish measured 28½ inches in length; depth 8 inches; and weighed, dressed, 7 pounds, 3 ounces. The fish was taken with an 11-ounce Bristol steel rod, and a light line, by a boy 15 years old. He was 40 minutes landing his catch. Living in an isolated region young Bachman did not realize the value of his trout. Scores of men can be found who will verify the above. Young Bachman's trout is easily at the head of any ever taken in Pennsylvania waters.—Grit, Oleona, Pa.

On receipt of the clipping I wrote Edward Bachman as follows:

I am deeply interested in the story of your big trout, and should like to have you get me letters from 2 or more well known business men who saw the fish measured and weighed, verifying the newspaper report. If you could get at least one man to make an affidavit of the fact it would be all the better. I have no record at hand as to the biggest trout ever taken in Pennsylvania, but have no doubt this one is it.

W. J. Bachman replied as below:

I herewith enclose a letter of verification regarding the trout my brother Edward caught in May last. The names appended to same should be sufficient authority as to the absolute truth of the measurement and weight of the fish. I hope to see the matter published in RECREATION and thank you for your kind interest.

Walter J. Bachman, Oleona, Pa.

Thornhurst, Pa.

To whom it may concern:

We, the undersigned, do hereby certify that the trout caught, out of a branch of the Lehigh river, by Edward Bachman, in the spring of 1903, was 28 inches long and weighed 7 pounds and 3 ounces.

Clinton Heller, J. P.

R. C. Drum, P. M.

WORTH FULL CREDIT.

Will you kindly decide through RECREATION an argument on the reply which was written to the following question by a schoolgirl:

Name the 3 kinds of life forms that are found in the ocean?

The answer was, the warm blooded class that come to the surface to breathe, like the whale; the true fish class, as, shark,

codfish, salmon and trout; and the lowest form, as coral, sponge, etc.

The answer was marked correct, with the exception of the salmon and trout, which had been crossed off; and the whole answer was given a mark of 8.

What I want to know is, what class do the trout and salmon belong to?

I get most valuable information and news from your magazine.

Jas. P. Besse, Hartford, Conn.

ANSWER.

In the first place, the question is without point. Even the most elementary knowledge of zoology should have kept any teacher from asking such a question. Whatever the person asking the question may have had in mind, it is evident that the answer is as good as any that could be given. If shark and codfish are accepted as right, salmon and trout should also be accepted, for they are equally right. Salmon and trout are found in the ocean, just as sharks and codfish are. I should say that the answer is much better than the question, and worth the full number of credits.—EDITOR.

FISHING ROD

No. 735,471. Elliott H. Crane, Kalamazoo, Mich., assignor to O. Le Grand Allen, Benton Harbor, Mich. Filed May 18, 1903. Serial No. 157,630.



Claim.—The combination of a suitable grip-section A; section B, each section consisting of a central tapered steel rod *e*; a plurality of tapered steel rods *e* spirally arranged about the same; ferrules *bb* into which the ends of said rods are rigidly secured; ferrules *b* centrally arranged on said sections; and a tip section C formed of a tapered steel rod, the taper of said rods forming each section being uniform with that of the rods of the adjacent sections, etc.

NIBBLES.

I have just run up from Catalina where the fishing is beyond belief, and so, likewise, is the waste of good fish. Tons on tons of yellow tail, albicore, black sea bass, etc. are killed and thrown back into the ocean. I tried to organize a movement toward tagging the fish with a small aluminum tag, bearing name and date, and then releasing them uninjured, thus increasing

the interest in future fishing as well as preserving the fish; but at present the desire to be photographed alongside a ton or so of 25 pound yellow tail is too strong to overcome. When people learn to be ashamed, instead of proud, of such slaughter we may hope for something better.

Herbert Earlscliffe, Santa Barbara, Cal.

We have a few bass, but nearly all are infested with worms. What is the cause?

Carl Clark, Brownsburg, Ind.

ANSWER.

You do not state the nature of the worms nor their position, whether in the intestines, free in the abdominal cavity, or in the muscular tissues. Worms of various kinds are common in trout, bass, and other fishes, and in the case of some bodies of water, like Yellowstone lake and Lake Tahoe, practically every fish of a given species will be infested. These worms, however, ordinarily do no harm, and the fishes affected may be eaten with impunity.—EDITOR.

A newspaper clipping sent me some time ago stated that Thomas Voorhees and James Mulhall, of St. Louis, Mo., had caught 55 pike, weighing over 225 pounds, in 2 days. I wrote these men and Voorhees replies as follows:

We caught the fish, and could have caught more if we had worked harder.

Tom Voorhees, St. Louis, Mo.

These 2 men are recorded in the fish hog book thus: Voorhees, number 979, and Mulhall, number 980.—EDITOR.

I spent last July at Lake Massabesic, where my folks have a cottage. Having learned the haunts of the fish during previous visits, I was able to keep our table supplied with pickerel and bass. The lake is well stocked and the fish are of fair size. The lake covers 1,100 acres and its greatest depth is 60 feet. I caught the largest bass taken from it last summer, a 4½ pounder.

H. G. Sanford, Manchester, N. H.

The biggest trout ever caught in Pennsylvania was taken from the waters of Spring creek, within Bellefonte borough limits, by Al Hoffman, a local fisherman. The trout was of the rainbow variety and measured 25 inches in length, was 5½ inches deep across the side, 3¼ inches across the back and weighed 6¼ pounds. It was caught on an eel set line. In its mouth were found 6 fish-hooks and pieces of line. The fish is to be mounted and sent to State Fish Commissioner Meehan.—Philadelphia Ledger.

Can any reader of RECREATION tell me where there is a good place for trout fishing on Beaverkill creek? Is there a good boarding house in the vicinity? Is a fee required from non-residents for fishing in Maine? F. H. L., Monticello, N. Y.

GUNS AND AMMUNITION.

Anybody can shoot all day, but a gentleman always quits when he gets enough.

HOT SHOT FOR THE AUTOMATIC.

I appeal to the sportsmen of America in the name of sportsmanship, in the name of common decency, to take a stand against that infamous bird exterminator, the automatic shot gun. This gun is being sold at a price that places it within the reach of every market hunter and farmer's boy in the United States. Its introduction simply means the extermination of our quails and ducks in a few years. How many quails would there be to-day if the quail net and the quail trap had not been legislated out of existence? Do you not know, can you not see, that this deadly automatic gun, in the hands of market hunters and farmers' boys all over the United States, will prove even more of an exterminator than the quail net? You will admit the quails are scarce enough now. Do you think this deadly gun, firing 6 shots before the covey can get out of range, will make the birds more plentiful? Market hunters and game hogs may tell you they will kill no more birds with an automatic gun than with a double barrel. One market hunter said he used a pump and always picked out a bird on the outskirts of the covey, and, if he missed, kept on firing at that same bird. Another said that the majority of market hunters use double barrel guns in preference to pumps because they do not want to kill too many birds.

Any man who has brains enough to commit the alphabet to memory knows such talk is rot. All market hunters and game hogs are built on the same lines. With this automatic gun such a man will fire 2 shots on the ground. He will take aim, pull the trigger twice instantly, and 4 more times before the covey is out of range. Five birds on the ground with the first 2 shots and 3 out of the covey with the next 4, total 8 out of a covey of 15, before the birds can get out of range!

Suppose he only gets 3 on the ground and 2 on the rise; what do you think he will do to the others when they begin flushing under his feet, one or 2 at a time? What do you think will be left for you the next day when you look for this covey and other coveys which have had the misfortune to come within his range?

Sportsmen all over the country are crying for better game protection. "Shorten the open season"; "Prohibit the removal of game from the State"; "Make a limit of 20 birds to the gun for a day's shoot"; "Prohibit the sale of game altogether"; "Feed the birds during the winter"; "Tax the gun"; "Tax the shooter." These

are topics constantly being discussed. In the face of all this are you going to stand idly by and see a gun introduced that will exterminate the quails and ducks so fast you will not need any game laws? This is not cheerful reading for the lovers of quail shooting, but they can console themselves with the market hunters' statement that when the birds are gone there will always be plenty of clay birds. Consoling, isn't it?

Here is one way of heading off the automatic gun. Let 2 or 3 prominent sportsmen in every town request their friends and associates to sign a notice like the one printed below, then present it to the more prominent dealers. If any sportsman should refuse to sign, make it clear to him that his presence is not desired at future trap events.

NOTICE

To Dealers in Sportsmen's Supplies:

We, the undersigned, respectfully inform you that if the automatic shot gun is offered for sale in your establishment we shall feel obliged to withdraw our patronage.

I trust there are in every town a few high minded sportsmen who will take up this matter and serve these notices on their gun dealers. If any dealer should decline to accede to this appeal for the protection and preservation of our game, then never buy another dollar's worth of him till he sends those automatic guns back to the factory. I further suggest that in case the Winchester Arms Company puts out such a gun, every true sportsman should decline to use any shells, ammunition or firearms made by this company. Any company that has no more regard for the preservation of our birds, or for the future pleasure of sportsmen than to introduce such a bird exterminator does not deserve the patronage of any sportsman. Such people are on a par with those who wanted to manufacture quail nets, and should receive the same treatment.

A few days ago I took one of these automatic guns out and shot it, just to see if it is as deadly as RECREATION has pronounced it. I was simply amazed at the execution, the awful destruction that could be wrought with this machine. The quail net or the quail trap is a gentleman's implement compared with it.

W. J., Philadelphia, Pa.

I read your article on automatic guns with deep interest and feel that every man, woman and child in the country should raise their voices in protest against the manu-

facture of such murderous weapons. Neither should any sportsman use the so-called pump gun in pursuit of game, as slaughter is condemned by all men of sound reasoning.

When I think of the vast army of shooters with modern weapons, and the rapid depletion of the game supply, owing to lax laws or the non-enforcement of existing ones, I really long for the old muzzle loader to re-appear, and with it the covers teeming with game as in olden days.

Let sportsmen use the pump gun at the trap if they so desire, but let us make every endeavor to prevent its use, both by law and public sentiment, when game is to be pursued. All can foresee the inevitable result as regards our game supply, unless such action be taken.

There is absolutely no reason for the existence of pump guns, and the placing of automatic guns on the market is nothing short of crime. Let us work for laws that will allow any officer to arrest all persons found with an automatic gun in their possession, or better still, laws to prevent the manufacture of such weapons.

Even the former course would stop this nefarious business. After public sentiment became thoroughly aroused the repeating gun would meet the same fate. There should also be laws preventing spring shooting everywhere, and shortening the open seasons in fully half the States in the Union.

Down with the automatic gun; down with the repeating gun; down with everything everywhere that does not savor of gentlemanly sport.

Edward H. Goodnough, Allston, Mass.

I heartily approve your protest against the manufacture and use of automatic shot guns, and earnestly hope that every American naturalist and every lover of wild life will do likewise. I intend doing everything in my power to help secure the passage of laws to prevent the manufacture, sale and use of such engines of destruction as you have described. Automatic shot guns belong in the same class as the punt gun for ducks and dynamite for fishing.

This is no time to mince matters. People who are not in favor of the protection of the few wild creatures now remaining are, necessarily, against it! I believe in decent sport; but not in wholesale slaughter. The American people are not so hard up for something to eat that every hunter should need to annihilate every covey of birds that rises before him. Surely, every true sportsman and every person, young or old, who is interested in American birds, will be in sympathy with your warfare against automatic guns, and I hope the most of them will rally to your support.

W. T. Hornaday, New York City.

I am glad you have entered a crusade against the manufacture and use of automatic shot guns for killing game. It can not be possible that any real sportsman will look with favor on this attempt to gain so great an advantage over the birds, which now are put to their extremities to avoid death at every turn. It seems too bad that men will be so unmindful, not to say cruel, in their efforts to slay these fast disappearing beauties of creation. It is bad enough that men kill as they do, but to add weapons that are so destructive, just for slaughter, is barbarous.

Our Legislature does not meet until 1905, but this matter will be brought before our association in January, and we will work actively to keep such guns out of this State at least.

E. C. Farrington, Sec'y,
Maine Sportsmen's Fish and Game Ass'n.
Augusta, Me.

I note that the Winchester Company intends to manufacture an automatic gun. We do not want it. We have plenty of murderous weapons now, though they are not so deadly as the automatic gun would be. Following is copy of a letter I sent the Winchester Company: I hear you are making preparations to manufacture an automatic gun. No sportsmen who are interested in the protection of our fast diminishing game will use any such gun. We have repeating, double and single guns by the thousands, yet you wish to make a weapon that is far more murderous. If you manufacture such a gun you are doing an unfair business, and all real sportsmen know it. I would not use such an arm if you would give me one.

Albert Shelley, Madelia, Minn.

I have read your editorial in RECREATION against the use of automatic and magazine guns; also draft of bill to be enacted against their use. I find here a strong sentiment among the better class of sportsmen against the use of these 2 murderous inventions, considering the condition of the game at the present day. Some of the duck-shooting clubs are beginning to taboo the use of these slaughter machines in hunting game, and I do not think there will be much opposition to the enactment of a law prohibiting their use. John Sharp, State Fish and Game Com'r., Salt Lake, Utah.

THEY ADVISE WINCHESTER.

Spokane, Wash.

Winchester Repeating Arms Co.,

Dear Sirs—I noticed recently a news item in one of our foremost progressive sportsmen's magazines to the effect that you are about to begin the manufacture of an automatic shot gun. While it is not my pur-

pose to attempt to dictate the future business policy of your firm, yet I protest against your taking chances of ruining the good reputation the Winchester Company has enjoyed these many years by putting on the market such a destructive weapon as this new shot gun promises to be. The game in the country is being killed off rapidly. Many States have prohibited the sale of game entirely, and other States will follow their example. I predict that if this new gun is put on the market there will be a whirlwind of disapproval among all true sportsmen and a quick and determined move toward legislation to prohibit its use. I have now 2 of your guns, a rifle and a shot gun; but if this new engine of destruction which you contemplate making is ever marketed you may count me in as fighting in every way possible against its sale and use.

J. E. Bates.

Aldan, Pa.

The Winchester Repeating Arms Co.,

Dear Sirs—I am informed that you are about to manufacture and place on the market an automatic shot gun. If you will listen to one who has used Winchester goods for years, you will confer a favor on multitudes of sportsmen, who feel regarding the manufacture of the proposed death engine as I do. Such a weapon would only be sold to boys and men who are in reality pot hunters, who shoot at anything and everything that wears fur or feathers, and as long as it remains in sight, and who are not sportsmen. A true sportsman would not seek to reduce the number of our game birds or game. The scarcity of game to-day is due chiefly to the use of the repeating shot gun in the hands of indiscriminate persons. The production of an arm more rapid in its manipulation for hunting purposes would bring forth condemnation from thousands of true sportsmen who have made the Winchester company what it is to-day.

T. H. Seavey.

Franklin, O.

Winchester Arms Co.

Dear Sirs:

I learn through RECREATION that you are intending to manufacture automatic guns. Permit me to raise my voice against your doing so. Already our fields and forests are nearly tenantless. Few of our beautiful birds are left and the little creatures of the fields and woods have gone with them. I plainly see that in a few short years we shall have none. The automatic gun, devised through greed, will rob all alike, the sportsman, the lover of nature and the farmer, who is benefited directly through the birds.

It seems the chief delight of many people to destroy the most essential, the most use-

ful of our birds. The flintlock, the muzzle loader, the breech loader, the repeater, have been used to depopulate our fields; and now comes a gun that will make destruction complete. In the cause of God's creatures, appealing as one who loves them all, I entreat you not to place this deadly arm on the market.

C. H. Morningstar.

Morgantown, W. Va.

Winchester Repeating Arms Co.,

Dear Sirs:

I have learned through RECREATION that you contemplate the manufacture of an automatic shot gun.

You probably figure that by catering to market hunters, pot hunters and game hogs you could make a good interest on the money put into the special equipment required to manufacture the gun. Possibly this is true, but your action would certainly meet with the stern disapproval of every true sportsman in this and every other country. I assure you I would never use an automatic shot gun or associate with any person who would use one. In thus stating my position in the matter I know I express the sentiment of at least 50 sportsmen in this little city and of thousands of other sportsmen throughout the country whose names and addresses I could furnish.

Hoping you will not see fit to add to the already too great effectiveness of game exterminating weapons, especially the shot gun, I am,

Bennett S. White.

Enid, Oklahoma.

Winchester Arms Company,

Dear Sirs:

I understand that you are preparing to build an automatic shot gun. Such a weapon should not go on the market for general use, as I have heard a number of lovers of shooting remark. There is a strong movement on foot for the protection of our birds and it will be my duty to discourage the use of an automatic shot gun in every legitimate way, as will be the case with hundreds of our citizens. I sincerely hope you will not manufacture any guns of this kind.

H. D. White,

Recreation Rod and Gun Club.

Setauket, N. Y.

Winchester Arms Co.,

Dear Sirs:—

I learn that you intend to manufacture an automatic shot gun. A gun of this kind can not be necessary for, nor desired by, any true sportsman. It can only be of use to pot hunters and duffers. I do not think it is for your interest to manufacture arms for either of those classes. The destruction of game is going on too fast in this country, and any who minister to the wholesale slaughter of game are doing injury to true

sportsmen, while the wiping out of game will certainly injure those engaged in the manufacture of firearms for sportsmen.

Selah B. Strong.

Trenton, N. J.

Winchester Repeating Arms Co.,

Dear Sirs:

I am informed you intend to manufacture an automatic shot gun. The placing of such a weapon on the market would hasten the extinction of the wild game of America, and this would be a national calamity. None but pot hunters and game butchers will ever use such guns; and if you cater to these classes you are no friend of sportsmen; I strongly protest against the manufacture of any such weapon.

L. W. Johnson

A CHAMPION FOR ROBIN HOOD.

I noticed a letter in RECREATION from A. W. Crampton regarding Robin Hood loaded shells, and a reply to it from C. H. Bentley. I have used several thousand of these shells the past 2 seasons, and am satisfied from reading Mr. Bentley's letter that he has not done much experimenting with Robin Hood loads. He may have shot a few, but the shells must have been of the cheapest class. I want to ask him to give them another trial, not on game, for the best of us blame the ammunition when we are out of form, but on penetration sheets.

I took regular stock loads of Robin Hood, $3\frac{1}{4}$ drams powder and $1\frac{1}{4}$ ounces No. $7\frac{1}{2}$ chilled shot. With these went Winchester Leader shells loaded with the same load of Du Pont smokeless and another batch loaded with 24 grains of Infallible. I made targets with each at 60 yards. There was little perceptible difference in penetration, but the distribution with Robin Hood was perfect, while both other loads clumped shot and left spaces in a 30 inch circle that a duck could have gone through. At 75 yards Robin Hood distribution was 100 per cent. better than either of the other loads, while the penetration was 12 sheets better than Infallible; but Robin Hood, after pass-Pont. I made 5 targets with each load at this distance, and that was the average. I then made 5 targets at 85 yards and 5 at 100 yards. The farther I shot the more pronounced was the difference. Every target showed Robin Hood to have the greatest penetration and to give the best pattern. At 100 yards Infallible would not stick the shot in the sheets, and on 2 of the targets not one shot struck the sheet. Du Pont showed better all the way through than Infallible, but Robin Hood, after passing the 50 yard mark, was greater in penetration and not only put more shot into the targets but distributed them far better. Mr. Bentley will get the same results if he will target these powders and not take snap

judgment because he happens to miss a few birds with the Robin Hood.

I know at least 50 good field shots here who will use nothing but Robin Hood, and all pronounce it stronger than any other smokeless. Robin Hood gives a little more smoke than Infallible or Du Pont, but even on damp days it is not great enough to interfere in the least with second or third shots. Recently I killed 5 ducks, one with each shot, with Robin Hood and No. $7\frac{1}{2}$ shot, and the last kill was as clean as the first.

The recoil from $3\frac{1}{4}$ drams is not so great as that from 24 grains Infallible and there is no loosening of the gun. I shoot a Parker \$100 grade in the field, and it is impossible to keep it tight many weeks when using Infallible powder. Robin Hood does not seem to loosen a gun any more than black powder. My opinion of Infallible powder is that the factory advises overloads: 24 grains of it give fearful recoil, and 26 are simply unbearable.

I advise readers of RECREATION to test Robin Hood carefully for 2 reasons; it is cheaper, and, I believe, better than any other. In addition, it is advertised liberally in RECREATION, and we ought certainly to favor those who favor us by advertising in our magazine.

John E. Clincher, Austin, Tex.

IT IS THE MAN!

Several of your correspondents say there should be laws in all the States prohibiting the use of repeating shot guns. I claim that the gun a man uses has nothing to do with his being a butcher. If a man wants to be a game hog he will be one no matter what gun he may use. Some of the biggest hogs I have ever known used muzzle loaders. I have seen another man take a repeater and a brace of dogs and go after birds. He would watch the dogs work, and when a bird got up would bring the repeater around, take time to shoot straight, would kill his bird, seldom shooting a second shot. I have known such a man to hunt all day and get 4 or 5 birds where he could have killed 50. He had as much enjoyment out of watching the dogs work as another would in shooting. It is all right to allow such a man to use a repeater and dogs. What we need is a law to send a man to jail who kills more than a reasonable number of birds in a day.

I have known a game butcher to take a muzzle loader and go to the woods and shoot everything that moved: chipmunks, phoebe birds, grouse, squirrels, rabbits, anything. It is natural for such men and it is only the fear of the law that keeps them from shooting any kind of stock, and even human beings. Such a man will sneak up behind a grouse, take a rest over a stump

or a log and murder it for the mere satisfaction of seeing it die.

Such men should be singled out in all communities and watched. Decent men should not associate with them, but should have them arrested every time they break a law.

Good work was done here along this line last season in regard to the fishing. I expect the same thing here in regard to game next fall. Our law allows each man 10 grouse a day, but this is too many. The limit should be cut to 6. 'If I get 4 in a day I am satisfied.

Before starting out for game I always run the shells I intend to use through the gun, then I know they will go through when I want them to. It is a wonder to me that so few shells stick when you take into consideration the fact that they must be absolutely perfect in diameter. Take a 30-30 and a .303 cartridge, measure them with a pair of calipers and see the small difference. Then try to run them through the same rifle and you will learn something at once. The human eye will detect a small difference that is hard to measure. Think of the millions of cartridges made and remember how unreasonable to kick because you happen to get a poor fit out of a possible 2,000. Those who expect perfection in this world should go back to the old muzzle loader, black powder, and shingle nails. E. L. Mason, Emporium, Pa.

If the game butcher you mention had had a pump gun he would have killed a great many more birds than he did or could kill with his muzzle loader. That's why all game butchers should be prohibited from using pump guns.—EDITOR.

WHY NOT ATTACK THE REAL OFFENDER?

Paddy Marlin is again at his old trick of bluffing. He has begun suits against 2 retail gun dealers in New Haven, alleging that they are selling Savage rifles which infringe Marlin patents. As in the case of his famous suit against RECREATION, he is dumping into the mails hundreds of thousands of circulars, which go to gun dealers all over the United States. Here is a quotation from the circular:

"Under the patent laws of the United States any person who makes or sells or uses a patented article, without permission of the owner of the patent, is an infringer."

Strange to say Paddy has not brought any action against the Savage Arms Co., the makers of the rifle which he says infringes his patents. Instead of doing this he jumps on these small retail dealers, each of whom it is said has sold one of these rifles.

Why does not Paddy attack someone of his size? Why does he not sue the Savage Arms Co.?

Here is Savage's reply to Paddy's hot air explosion:

Our attention has been called to a circular issued by the Marlin Fire Arms Co., with reference to a claim of infringement of patents made against the Savage 22 caliber rifle. It is a significant fact that we have not been sued for the alleged infringement, but suits have been brought against 2 of our customers in New Haven, Conn. We have already assumed all responsibility of these suits and are able to take care of them and intend to do so. We have the services of able counsel and experts, who assure us that our 22 caliber rifle is not an infringement of the Marlin patents, and, indeed, this must be apparent to all who are familiar with, or will take the trouble to compare the Savage and Marlin rifles.

Marlin was not, by any means, the first to produce or make a take down rifle. Our rifle is not like Marlin's, we are pleased to say.

We assure you that we are able to and will protect all dealers and users of the Savage 22 caliber rifles against all claims of infringement. We shall continue to maintain the high standard of excellence of our arms, and rely, as we have relied heretofore, on the trade and public to recognize real merit.

Yours truly,

Savage Arms Co.

Arthur W. Savage, Managing Director.

IN THE CLASS WITH DYNAMITE.

I am going to stop buying your magazine because I do not approve of your stand regarding the automatic shot gun and rifle. I like the latest improvements always, and I think you are trying to hold back inventive genius.

Rufus H. Skeel, Newburgh, N. Y.

I knew when I attacked the automatic gun that I should antagonize many men, but I am glad to know that where one man disagrees with me on this subject, thousands of others agree with me.

One man sent me a check for \$25 for the L. A. S. game protection fund, and said that if I could head off the automatic gun, or even if I could materially check its sale, he would send me another check for an equal amount. I have assurances from prominent sportsmen in a number of States that they will be able to pass our bill to prohibit the use of both the automatic and the pump guns in their respective States during the present winter, and I have not the slightest doubt that we shall procure the passage of such laws in all the States during the next 2 years.

Generally speaking, I am in favor of advancement in all the arts and sciences, but there is a limit to what should be allowed in various lines. For instance, if a revolver

should be invented and placed on the market that would fire a cartridge making no noise whatever, thus enabling a footpad to shoot down a man at night on a lonely street or road, without any possible danger of being caught in the act, I should be in favor of prohibiting the use of such weapon by law.

Dynamite is one of the most important inventions of the 19th century, and has proved of great value to commerce in many ways; yet when a man uses it to fish with, we say he should be punished by law, and nearly all the States have laws prohibiting the use of dynamite in that way. I regard the man who would hunt game with an automatic gun in the same light as I regard the man who fishes for trout or black bass with dynamite. Many thousands of the best sportsmen in this country agree with me in this.—EDITOR.

LOADS FOR THE 32-40.

Would say to S. B. that I have a 32-40, with nickel steel barrel. I think it is about as near an all around rifle as there is on the market. It is a matter of choice between that and the 38-55 with nickel steel barrel.

The velocity of the 32-40 is about 1,400 feet a second at muzzle, with black powder; with high pressure smokeless, about 2,050 feet. The 32-40 high pressure is a little more powerful than the 30-30, about the same as the Savage .303 and the 32 Winchester special, and about $\frac{3}{4}$ as powerful as the 30-40. It is as accurate as any cartridge, whether black or smokeless. The Savage rifle is made for the 32-40-165. The other 32-40s mentioned are practically out of use.

I use Lafin & Rand's Sharpshooter smokeless. Twelve grains by weight will give the same power as 40 grains black and costs about the same. This may be used with lead bullet. For high power load with metal cased bullet use 20 to 23 grains of the same powder, giving velocities from 1,925 to 2,050 feet. For the miniature, I use the 99-grain sharp pointed bullet, of No. 31,949 in Ideal Hand Book, and 5 or 6 grains of any shot gun smokeless. This does not tear small game. Use short range shells with groove. For the medium load, 12 grains, I use Ideal bullet No. 321,232. It will seat with regular 32-40 tool and has a groove for shell to crimp into. Make bullets 1 part tin to 16 or 18 parts lead.

The butt stock is a matter of choice; I prefer the shot gun butt for a hunting rifle. Do not use wadding or any method of filling the shell in the medium loads; leave the powder loose in the shell. Never allow bullet to rest on smokeless powder in shell. If black powder is desired for miniature loads, 13 to 15 grains is correct. These

loads are all accurate and cheap. Always use great care in cleaning any rifle after using smokeless powder with metal cased bullets.

Ernest A. Dunn, Boston, Mass.

DEFENDS THE PUMP GUN.

(Printed verbatim.)

I have been a subscriber to Recreation since Nov 01 and my subscription is paid up to NOV 08 I read all of the stories there in with much pleasure and in fact read a;1 there in there is many things that make me tired. now I am about 30 years old and have hunted Bob Whites more than half of that time in season and have used most all kinds of guns, this fall I sold \$40 00 I.C. Smith and bought a Winchester pump gun. I have killed 203 Quails since NOV 1 6 to Jan 1/. I find on page 57 in Jan number of Recreation your crazy bill to prohibit the use of all magazine guns, If a man ever learns to shoot a Winchesyer pump gun he can never be satisfied with any thing else? It is more than foolish for a man to pay from \$50000 to \$500 for a Parker I.C. Smith or any other make of gun when for \$20 00 or 25 00 he can buy Winchester pump gun that will out last and out shoot any of all of them.

Now as I have said my subscription is paid upto Nov 04 it would please me verry much to have mt money refunded taling out pay for what copies I have recd , ?I will, not help even ever so little to support a magazine that is or is going to take steps to prohibit the use of the best cheapest and handist shooting gun on resord especially one that I prefer above all others you are very strong in using your pet name of Gamf Hog and I in this letter am saying just what I think I am not a game hog never sold a quail in my life am not taking offence at your game goh on my account.

Please print this letter and do as you say you do every body and give the Winchester people what they so justly deserve I am going to send them a coppynof this letter As you must know Mr. Shields I have nothing against you or Recreation only you are against the bestn gun in the world and a shoot that gun A Winchester Repeating Shot Gun fl . Plet me heare that you have taken a moer sensible view of this subjekt and burned all of the matter pretaining ti this crazy bill or please drop merfoomrom your list

Yours Respt
Clifford.S. Atkinson

ANSWER.

Here is my check for \$1. It affords me great pleasure to drop your name from my subscription list. All such illiterate, unwashed, unkempt critters as your letter shows you to be may be safely counted as defenders of the pump and automatic guns. The educated, cultivated people are all opposed to such weapons. The Winchester people will of course feel proud of you as a champion.—EDITOR.

THE ELTERICH SHELL.

In your November issue G. D. Earll asks for a report from some one who has used the Elterich patent rifle shell. I can give him a little light on its possibilities. Two years ago, when on a vacation, I made an exhaustive test of one. It was one of the first made, and I used it solely in a repeating shot gun, so that Mr. Earll's question as to whether it can be used in such a gun may

be answered in the affirmative. In fact, a distinct form of the shell for use in repeating guns is now on the market.

I tested the appliance at all ranges between 10 and 100 yards, inclusive, firing 500 32-caliber short smokeless cartridges in it. Its work may be described as being about equal to what a good revolver would do. At 75 yards I was able to get about one-third of its shots into a 12-inch circle, and by using an improvised detachable rear sight V-shaped, it did a little better. At shorter ranges its accuracy was, of course, greater in proportion. That its accuracy is no greater than this is due to the fact that it does not fit the gun barrel perfectly, and if it did fit any tighter than it does it would play havoc with the extractor. A surprising thing about the work of this shell is the penetration secured with the above named cartridge. At 75 yards the bullets penetrated an inch of oak, which is certainly good for so short a piece of barrel as it offers. I never had any trouble with kelholing. For an occasional shot at short ranges this shell would prove satisfactory, but I warn Mr. Earll that in its use there is a sidewise blast of gas at its muzzle when the bullet leaves it, that is destructive to the inside of the barrel in which it is used.

P. B. Jenkins, Kansas City, Mo.

AN EXPERT ON DRIFT.

In November RECREATION are some remarks on drift which are slightly in error.

Until a few years ago it was believed by expert artillerists that the axis of a projectile remained throughout its flight parallel to its original position in the gun; and this would indeed be the case but for the resistance of the air.

When sea coast mortars were first proposed to throw elongated projectiles just as rifled guns do, the objection was made that such projectiles would fall on their bases instead of on their points. Experiment has shown, however, that such is not the case. We have many 12-inch mortars now mounted along our coast, which throw projectiles 3 to 4 feet long. These may be plainly seen during flight and they invariably fly like arrows, point first, changing direction by as much as 90 degrees from their original position to that of impact. But while the old theory has fallen to the ground the theory of drift is still undisputed and is borne out by actual results. Projectiles having right hand rotation generally drift to the right. I say generally because it has been found that projectiles thrown with extreme velocity sometimes drift to the left, although they rotate in a right hand direction. It is easier to theorize regarding this phenomenon than to satisfactorily explain it. The sights of the

army rifle are experimentally adjusted for drift.

R. R. Raymond,
Capt. Corps of Engineers, U. S. A.,
Fort Riley, Kans.

SMALL SHOT.

C. B. H.'s comment in October RECREATION concerning pump guns is amusing. I have used a pump gun many years, have hunted with others using pump guns, and I know that it takes a man of exceptional skill and quickness to kill 3 birds out of a flushed covey. Mr. H. evidently believes a man with a pump gun can get in 5 or 6 shots at a covey, a feat I have never seen accomplished. Birds are crippled by poor marksmanship at short range as well as at long range. In a scattered covey, occasionally 2 birds will rise in quick succession, and if, a few moments later, a third bird should rise, the man with a repeater is ready to shoot it, thus having a distinct advantage over the man with a double barrel, whose gun was emptied in shooting at the first 2. The principal advantage, therefore, of the pump gun is in being ready to shoot at 3 or more birds which unexpectedly rise at quick intervals in a scattered covey.

C. W. Murphy, Salem, Ind.

It seems to me that in November RECREATION a great injustice is done to Robin Hood powder. I have used shells loaded by that company for 3 years and find they compare favorably with other smokeless ammunition. C. H. Bentley hints that the powder should be called semi-smokeless. Anybody who has ever used Peters so-called semi-smokeless ammunition would look on this as an insult to the Robin Hood Company. H. W. B. complains of the shells splitting and of the heads blowing off. Probably his gun has an expanded chamber. Another man says that the crimp is bulged, so as to make the shell stick in the chamber. This may have been true of a small lot of shells, but why state it as a general fact? I have had the same trouble with Winchester ammunition, but I do not make the charge that all Winchester shells have a defective crimp.

H. S. Hill, Washington, D. C.

I am a regular reader of your valuable magazine and note with interest the different opinions on guns and ammunition. I own a 30-30 Savage and succeeded in getting a large buck last fall in the upper peninsula of Michigan. There were 32 hunters camped within a radius of 2 acres where we were, and most of them had 30-30 rifles of different makes. I saw many deer killed by them. In almost every case the hunter had no trouble in finding his

game, notwithstanding there was no tracking snow. One fellow, however, followed a deer $2\frac{1}{2}$ miles by the blood after he had shot it 3 times with a 45-70 express. I think the 30-30 and the 32-40 the best deer guns for this country.

S. L. Bennett, Alma, Mich.

Does the Savage Arms Company manufacture ammunition for its 25-35 rifle? If so, can the shells be reloaded as often as those made for the .303? What is the extreme killing range of the 25-35?

W. E. R., Victor, Colo.

ANSWER.

It is the intention of the Savage Arms Company to put on the market 25-35 ammunition in the near future. It is impossible to give the exact killing range of the 25-35, as this has never been determined by experiments, but I should judge it to be in the neighborhood of 1,200 to 1,300 yards. The 25-35 ammunition of the bottle-neck type can be reloaded as many times as the .303 shell.—EDITOR.

Please tell me how to keep shot gun barrels from rusting; also whether shot gun wick plugs can be used successfully.

W. H. Pringle, McIvor, Mich.

ANSWER.

The wick plugs are the best device I have ever seen for keeping gun barrels from rusting inside. In order to keep the barrels from rusting outside you should cover them thoroughly with Cedaroleum, or with any good gun grease, and then wrap the gun in heavy paper. It is possible to keep rust from attacking the gun without wrapping it, but if it is not wrapped it should be examined frequently and re-oiled. Cedaroleum is made by The Cedaroleum Co., of Perkinsville, Vt.—EDITOR.

I have used nearly all makes of rifles and thought the Winchester 25-35 the best, but now I think the Savage is far better. The Marlin is as good as no gun at all and far more dangerous.

G. L. Manor, Post Falls, Idaho.

I should like to hear from some sportsman who has used the 44-40 on deer and other big game. I have one which I intend to take on a hunting trip next fall.

Arthur A. Borck, Rocklyn, Wash.

It is a fact that the repeating shot gun is killing or crippling all the game we have here. It is strictly a game hog's gun. Give me a double barrel every time.

C. B. Colt, St. Joseph, Mo.

I see that 2 readers of RECREATION ask about Magniscope rifle sights. As I un-

derstand the Magniscope, it is a cheap telescope sight.

L. A. S., 8942, Pittsburg, Pa.

If .30-30, Westmount, Canada, would like to see a Magniscope rifle sight he can do so by looking me up.

E. G. Brewer, Montreal, Can.

Which is the better gun to take into the Maine woods—the 38-55 or the Winchester 32 special?

"Farming? I know what it is," declared the Congressman from Indiana; "father and 5 of us boys used to work all the year round to raise stuff to feed 5 horses. Finally 2 of the horses died, and that enabled Charley and me to get away from the farm and come to Congress."—Argonaut.

"Young man," said the stern parent, "do you know what is the greatest aim in life?" "Sure!" said the unregenerate. "That feller on th' Indianny wot smashed th' bull's-eye 5 straight at 4 miles wid a 13-incher."—Baltimore News.

RECREATION is a necessary part of the outfit of every user of gun and rod, a boon to the sportsman; and a word in season to the game hog.

S. S. Mulford, New York City.

Of all sad words of tongue or pen
I think the saddest ones are when
Your gasoline has run its course
And small boys chorus—Gittahorse!
—Buffalo News.

It is almost as good as a day in the woods when RECREATION comes, the "almost" in this case implying great pleasure.

Hale H. Richardson, Boston, Mass.

Nell—She has an automobile tongue.

Belle—What do you mean?

Nell—Oh, she's always running other people down.—Philadelphia Record.

I have taken RECREATION for the past year and a half, and think it the best magazine on the market.

Bernard Verbeck, Alameda, Cal.

Bertie (at a concert)—What are those 2 people singing at once for?

Cissy (aged 6)—Why, to get it over all the quicker, of course!—Exchange.

RECREATION is a perfect magazine.

Harry Baker, Blockhouse, Wash.

Uncle Ezra says that kissing will remove paint,—Schoolmaster.

NATURAL HISTORY.

When a bird or a wild animal is killed, that is the end of it. If photographed, it may still live and its educational and scientific value is multiplied indefinitely.

SNAKE BITE AND ITS TREATMENT.

I read in September RECREATION, A. K. Stetson's article on "Treatment of Snake Bite," and was surprised to notice several errors therein. He advises one bitten by a poisonous snake to use permanganate of soda. There is such a drug, but it is not used as an antidote for snake bite. I suppose he means permanganate of potassium, from his saying it is the only known agent that will fully destroy the venom without also destroying the tissues.

Even that is not so. Permanganate of potassium is apt to produce ulceration, and in consequence, healing may be long delayed. Still, it is a good remedy to use, if none better be at hand. Chromic acid has been found superior, as its action is quicker and no destruction of tissue is likely to occur after its use. If employing permanganate of potassium, use a 1 to 2 per cent. solution hypodermically in and around the wound. In making use of chromic acid, Professor Kaufmann, of France, who instituted a series of experiments with it, and obtained from it the best results, advises 2 or 3 drops of an aqueous solution, 1 to 100, of chromic acid, injected to the extreme depth of the puncture of each fang. Then several similar injections to be made around the wound. The infected part to be kneaded, to bring the acid more thoroughly in contact with the venom, after which the wound to be punctured with the point of a knife to allow the escape of serum, continuing the kneading to facilitate the discharge.

With the treatment I advise hypodermic injections, not in the wound, of strychnine until its effect can be noticed, shown by slight muscular spasms. The patient should not be allowed to sleep, except for short intervals, for the first 24 hours.

Mr. Stetson advises whiskey to be given "copiously, not fearing intoxication." It should be remembered that a large quantity of whiskey acts as a heart depressant, while a small quantity is a stimulant, and as the heart is to be supported by stimulation, under no circumstances should the person bitten be made intoxicated.

Many persons believe that nearly all snakes are poisonous and should be destroyed. Such belief is largely the result of ignorance combined with prejudice. Man, as a rule, in his savage desire to kill something, loses no opportunity to destroy the life of every creature whose usefulness he does not understand. Snakes are useful ani-

mals, destroying millions of such pests as mice, rats, moles, poisonous insects, etc., and in consequence ought to be allowed to live. Poisonous snakes, of which there are but few varieties in this country, should, of course, be destroyed.

The only poisonous snakes in the United States, whose bite can cause death, are the rattlesnake, copperhead, cottonmouth, water moccasin and coral snake. The last named, however, is found only in the far Southern States, and there, as a rule, living under ground. The poisonous snakes of this country can be easily distinguished from the non-poisonous ones by a pit or hole, located on each side of the face, between the nostril and the eye. These are called "pit-vipers," and have a vertical pupil; the only exception being the coral snake, which has no such pit and has a round pupil. Another distinguishing feature in poisonous snakes is the presence of 2 or more fangs, located on the anterior part of the upper jaw. The spreading adder, that so many believe to be poisonous, is as harmless as a kitten; still thousands are killed every year by persons ignorant of its usefulness, and who mistake it for the deadly copperhead, which it somewhat resembles.

G. E. Roehrig, M. D., Chicago, Ill.

In the August number of your splendid magazine I find a description of traps and snares to catch snakes, also mention of the best antidote to the venom of the poisonous snakes of North America.

I desire to say a word against the condemnation of ammonia as an antidote to snake venom. I do not undervalue the authority quoted, but during 35 years of practice I have treated patients suffering from bites from most, if not all, varieties of poisonous reptiles in Texas, Arkansas, Indian Territory and other Southwestern States. I treated my patients conscientiously and successfully, and I used ammonia.

It is well known to the profession that poisons like that under consideration produce an acid condition of the blood of the victim. We also know that ammonia is an alkali and a diffusible stimulant. To neutralize the acid produced by the venom and at the same time stimulate the heart's action seems to me a rational treatment. I have yet to see any destruction of the veins from its use. I suppose that deplorable condition might occur from its abuse. As to permanganate of potash, I deem it an excellent after-treatment, as it abounds in oxygen and therefore and thereby elim-

inates organic salts and possibly other morbid agents. Permanganate of potash must have time to disorganize and give off free oxygen, leaving the potash to neutralize the acid in the blood, as ammonia does. Thus both drugs stimulate the heart and destroy acid; ammonia acts most promptly and is therefore preferable.

I read a statement recently that house spiders were not poisonous. At that time I had 3 cases dangerously sick from spider's venom.

C. E. Frost, M. D., Ranger, Tex.

LET THEM STAY WHERE GOD PUT THEM.

The following editorial, which recently appeared in the Cleveland Press, was read aloud in every school room in that city, by order of the Cleveland Board of Education:

The song birds of Ohio are to stay where God put them—in the woods and fields. He who notes even a sparrow in its fall has not forgotten the little troubadours of the sunny skies. He has raised an agency for their defense in their virgin sweetness, in their primal beauty and in that which gives them their beauty and sweetness both, their native liberty. There is at least one statutory law in which the hand of God is surely visible, and it is being righteously enforced. No longer, in Northern Ohio, at least, will the hedges, trees and sky be robbed of their richest treasures to adorn human vanity.

It is a baffling physiological question why a woman wants a bird on her hat. It is a confession carried aloft like a banner, that she needs unnatural aid to make her beautiful. For the bird adorns the woman; no woman adorns a bird. To refined minds the woman is prettier without the bird; to all minds the bird is prettier without the woman. The bird on a woman's hat is a mark of murder, the most cruel and useless that the mind can conceive. It is even a mark of more than that. It is a constant reminder that the vanity of woman can ruthlessly throttle the sweetest music that ever kissed the soul, enslave the most perfect type of freedom, mar the purest thing of beauty in the world, and then place the evidence of her heartless crimes above her brow and ask us to look and think her more beautiful.

Is it then to be wondered at that humanity has sickened of it and has said through the law and game wardens, that the song birds shall stay where God put them—in the fields and woods?

There in their native element the song birds are man's first and holiest inspiration. They taught him his first note in music, and gave him his first dream of liberty. They are the greatest optimists in the world, teaching always cheer and hope. They croak no melancholy dirges, but sing only

the song of love, joy and praise. They bring into the heart of man naught but brightness and take from it naught but gloom.

Near to Nature's heart, where men and women have souls, the song birds suggest all that is best in life or to be longed for in eternity. They whisper to the child its first message from the Infinite, and carol to old age the glories beyond the vale. From dawn to night, from birth to death, they flood our days and lives with melody, and cheer with inspiration.

Let them stay where God put them—in the fields, in the woods, and in human souls.

THE GREEN PIGEONS OF INDIA.

The feathered game of India is as numerous as it is varied. While many of the species are those found in much higher latitudes, there are several peculiar to the country. Partridges, quails, pheasants, grouse and turkeys, together with various water birds, are found well distributed over the jungle land. Few of the many game birds, however, excel the green pigeon in delicacy of flavor and other edible qualities. This bird is found chiefly in the Northern and Western parts of the country, inhabiting the large tracts of jungle land or places where tall trees such as the mango or banyan flourish. It is always met in great numbers, 200 frequently being counted in a single flock. Its plumage is dull green, though the feathers on the neck and breast are gray. Its habits are identical with those of the ordinary blue rock, but its extreme wariness renders it exceedingly difficult of approach and the sportsman who can show a dozen brace as the result of a day's work may well congratulate himself. If one is lucky enough to approach a feeding flock, a single shot will frequently drop 5 to 10 birds, so closely do they perch together.

The best method is to first find one of their feeding places, which is usually a large banyan, or pipal, tree, go there before sunrise and await the arrival of the birds. They invariably select the Eastern branches and settle there sit quietly in the sun half an hour before feeding. While thus engaged not a bird stirs, and so closely does their plumage resemble the color of the surrounding foliage that it requires a sharp eye to detect them. About daybreak the birds begin to arrive in groups of 5 or 6 and soon the branches are fairly alive with them. Then it is that the sportsman must exercise the greatest care; not a twig must be broken nor a change made in his position. Slowly the pigeons arrange themselves and by sunrise some of the boughs are bent almost to breaking with their weight. Then with a quick move the gun is brought to the shoulder, one barrel

discharged at some well laden limb, the other into the flock as they leave the tree; usually securing from 10 to 20 birds. On an all day chase for them such a bag is seldom obtained. These birds are specially fine for the table during the cold weather, from November to February, when their favorite fruits are in season. The green pigeon is a much larger bird than the common blue rock, and while having many of the latter's characteristics, it does not frequent the vicinity of human habitations. With the natives the green pigeons are great pets, as when taken young they become-domesticated without much trouble.

Geo. T. Forbes, Harrisburg, Pa.

IMPORT SKYLARKS.

The skylark, *Alauda arvensis*, is a European songster which we have in America. The skylark is renowned in song and story all over the old world. It would be thought incredible in any country of which he is a native that we would not welcome his coming, and do all in our power to bring him to every part of this land. The skylark was brought to New York many years ago. I do not know how he has prospered or in how many Eastern States he is now found. The lark was brought to Portland, Oregon, about 1883, and has rapidly increased. I believe they have penetrated East of the Cascade range. RECREATION has correspondents in every State of the Union, and Canada. They could give us some interesting items as to where the skylark is now found.

If all the lovers of good music who live in the vast plain that stretches from the Arctic ocean to the Gulf of Mexico would contribute each a few cents and turn loose a few hundred larks, the glorious song of this bird would soon be heard, at one season or other, from Brownsville on the Rio Grande, to Edmondston on the North Saskatchewan. Of course, these Oregon birds are born citizens of the United States and have a right to sing wherever the stars and stripes float. The lark loves a prairie country. Hasten the day when we shall have more of these birds.

E. K. C., Kenville, Texas.

DO NOT IMPORT BIRDS.

In your September number, E. K. Carr says that we ought to have the nightingale, black cap, white throat, and several other European birds. Can it be that we have lost all appreciation for our own birds, that we are willing to crowd them out with aliens?

I have never heard any of his birds sing, and I never wish to as long as the wood thrush, our own black cap, and white throat,

and the cat bird visit our thickets and groves.

The fact that the habits of European birds named are known, avails nothing. Under different environment they may change. They would be patronized, our own birds neglected, and consequently driven from around our buildings. There is no guarantee that foreign birds would not acquire the evil propensities of the English sparrow.

It would be a cause for rejoicing among nature lovers of this country if Congress would forbid the importation of alien birds, quadruple the punishment for slaughtering our own birds, and fill the country with wardens to enforce the law.

W. E. Hammon, Buena Vista, Colo.

NATURAL HISTORY NOTES.

I bought some rabbits in Ulster county, N. Y., and in 3 weeks they all had big worms in their backs. The worms were white and about 1½ inches long. They could be pressed out by the fingers, and in the holes large scabs would form. Each rabbit had 2 or 3 of these worms in his back. Can you tell me through RECREATION what was the matter?

Down with the hogs.

Jess Roland, Brooklyn, N. Y.

ANSWER.

Nearly all rabbits are affected with grubs, such as you describe, during hot weather. I receive such reports as that you send from all parts of the country, and your surprise is not different from that of nearly every man who has attempted to handle domestic rabbits of any kind.—EDITOR.

A grey squirrel has a nest in one of our trees and is very tame. He often comes to our window to feed, and it is easy to entice him into the house, if the proper bait is used. It is a source of infinite delight to my 2 small people to hold nuts in their laps and have him climb up to get them. Of course the squirrel is timid, and the slightest movement on our part will send him flying; yet as long as we keep our seats he will move freely all about the room, and will even go from one room to another. There are several of these little fellows in the neighborhood, and the residents take great pleasure in feeding and protecting them through the cold weather.

Frank P. Lord, Burlington, Vt.

The porcupine may have his quills,

The elephant his trunk;

But when it comes to common scents,

My money's on the skunk.

—Cornell Widow.

THE LEAGUE OF AMERICAN SPORTSMEN.

GENERAL OFFICERS

President, G. O. Shields, 23 W. 24th St., New York.

1st Vice-President, E. T. Seton, 80 West 40th St., New York.

2d Vice-President, W. T. Hornaday, 2969 Decatur Ave., Bedford Park, N. Y.

3d Vice-President, Dr. T. S. Palmer, Dept. of Agriculture, Washington, D. C.

4th Vice-President, A. A. Anderson, 80 West 40th St., New York.

5th Vice-President, Hon. W. A. Richards, General Land Office, Washington, D. C.

Secretary, A. F. Rice, 155 Pennington Ave., Passaic, N. J.

Treasurer, Austin Corbin, of the Corbin Banking Co., 192 Broadway, New York.

STATE DIVISIONS

ALASKA

Dr. E. M. Rininger, Chief Warden, Nome.

ARIZONA.

M. J. Foley, Chief Warden, Jerome.

ARKANSAS

W. R. Blocksom, Chief Warden, Eureka Springs.

CALIFORNIA.

Dr. David Starr Jordan, Chief Warden, Leland Stanford University.

COLORADO.

A. Whitehead, Chief Warden, 303 Tabor Building, Denver.

CONNECTICUT.

Hon. F. P. Sherwood, Chief Warden, Southport; Dr. H. L. Ross, Vice-Warden, Canaan; H. C. Went, Sec.-Treas., Bridgeport.

DISTRICT OF COLUMBIA.

C. H. Townsend, Chief Warden, U. S. Fish Commission.

FLORIDA.

W. W. K. Decker, Chief Warden, Tarpon Springs.

GEORGIA.

J. J. Doughty, Chief Warden, Augusta.

IDAHO.

L. A. Kerr, Chief Warden, Kendrick.

ILLINOIS.

M. D. Ewell, M.D., Chief Warden, 59 Clark St., Chicago; F. M. Taber, Vice Warden, 144 Kinzie St., Chicago; G. C. Davis, Sec.-Treas., 123 S. Central Ave., Austin.

INDIANA.

John J. Hildebrandt, Chief Warden, Logansport; O. R. Moore, Vice-Warden, Anderson; Dr. M. L. Humston, Sec.-Treas., Goodland.

IOWA.

Carl Quimby, Chief Warden, Des Moines; C. C. Proper, Sec.-Treas., Des Moines.

KANSAS.

O. B. Stocker, Chief Warden, Wichita.

KENTUCKY.

Geo. C. Long, Chief Warden, Hopkinsville.

MAINE.

Col. E. C. Farrington, Chief Warden, Augusta.

MARYLAND.

J. E. Tylor, Chief Warden, Oxford.

MASSACHUSETTS.

Heman S. Fay, Chief Warden, Hazleton Block, Marlboro; J. E. Tweedy, Vice-Warden, North Attleboro; A. C. Lamson, Sec.-Treas., 194 Main St., Marlboro.

MICHIGAN.

J. Elmer Pratt, Chief Warden, Grand Rapids; R. S.

Woodliffe, Vice-Warden, Jackson; A. B. Richmond, Sec.-Treas., Grand Rapids.

MINNESOTA.

Dietrich Lange, Chief Warden, 2294 Commonwealth Ave., St. Paul; H. A. Moigan, Vice-Warden, Albert Lea; Prof. O. T. Denny, Sec.-Treas., St. Paul.

MISSOURI.

Bryan Snyder, Chief Warden, 726 Central Bldg., St. Louis.

MONTANA.

Professor M. J. Elrod, Chief Warden, Missoula; Sidney M. Logan, Vice-Warden, Kalispell; R. A. Waagner, Sec.-Treas., Bozeman.

NEBRASKA.

Fred. E. Mockett, Chief Warden, Lincoln; P. O'Mahony, Sec.-Treas., Lincoln.

NEVADA.

Dr. W. H. Cavell, Chief Warden, Carson; Geo. W. Cowing, Sec.-Treas., Carson.

NEW HAMPSHIRE.

Dr. A. F. Barrett, Sentinel Bldg., Keene; Sidney Conant, Sec.-Treas., Keene.

NEW JERSEY.

Percy Johnson, Chief Warden, Bloomfield; Dr. W. S. Colfax, Vice-Warden, Pompton Lakes; I. V. Dorland, Sec.-Treas., Arlington.

NEW MEXICO.

P. B. Otero, Chief Warden, Santa Fe.

NEW YORK.

John R. Fanning, Chief Warden, Powers' Bldg., Rochester; Col. R. E. Moss, Vice-Warden, Wallack's Theatre, New York City; Dr. C. C. Curtis, Sec.-Treas., Columbia College, New York City.

NORTH DAKOTA.

Dr. W. D. Jones, Chief Warden, Devil's Lake.

OHIO.

W. E. Gleason, Chief Warden, Mitchell Bldg., Cincinnati; A. C. Thatcher, Vice-Warden, Urbana.

OKLAHOMA.

W. M. Grant, Chief Warden, Oklahoma City.

ONTARIO.

C. A. Hammond, Chief Warden, Box 701, St. Thomas; D. L. Mells, Sec.-Treas., St. Thomas.

OREGON.

Robert F. Kelly, Chief Warden, Box 188, The Dalles; C. B. Cushing, Sec.-Treas., The Dalles.

PENNSYLVANIA.

C. F. Emerson, Chief Warden, 189 N. Perry St., Titusville; Hon. C. B. Penrose, Vice-Warden, 1720 Spruce St., Philadelphia.

RHODE ISLAND.

Zenas W. Bliss, Chief Warden, 49 Westminster St., Providence.

SOUTH CAROLINA.

C. F. Dill, Chief Warden, Greenville.

SOUTH DAKOTA.

D. C. Booth, Chief Warden, Spearfish; John C. Barber, Sec.-Treas., Lead.

TENNESSEE.

Hon. G. C. Martin, Chief Warden, Clarksville; Hon. Austin Peay, Jr., Sec.-Treas., Clarksville.

TEXAS.

Prof. S. W. Stanfield, Chief Warden, San Marcos; W. E. Heald, Sec.-Treas., San Angelo.

UTAH.

Hon. John Sharp, Chief Warden, Salt Lake City.

VERMONT.

S. C. White, Sec.-Treas., Woodstock.

VIRGINIA.

R. G. Bickford, Chief Warden, Newport News. C. O. Saville, Vice Warden, Richmond; M. D. Hart, Sec.-Treas., 1217 East Main St., Richmond.

WASHINGTON.

F. S. Merrill, Chief Warden, Spokane; F. A. Pontius, Sec.-Treas., Seattle; Munro Wyckoff, Vice-Warden, Pt. Townsend.

WEST VIRGINIA.

E. F. Smith, Chief Warden, Hinton,

WISCONSIN.

Frank Kaufman, Chief Warden, Two Rivers; Dr. A. Gropper, Sec.-Treas., Milwaukee.

WYOMING.

H. E. Wadsworth, Chief Warden, Shoshone Agency; Frank Bond, Sec.-Treas., Cheyenne.

Applications for membership and orders for badges should be addressed to Arthur F. Rice, Secretary, 23 W. 24th St., New York.

LOCAL WARDENS

CONNECTICUT.

County.	Name of Warden.	Address.
Fairfield,	George B. Bliss,	2 Park Row, Stamford.
"	Harvey C. Went,	11 Park St., Bridgeport.
"	Samuel Waklee,	Box 373, Stratford.
Litchfield,	Dr. H. L. Ross,	P. O. Box 100, Canaan.
Middlesex,	Sandford Brainerd,	Ivoryton.
New Haven,	Wilbur E. Beach,	318 Chapel Street, New Haven.
"	D. J. Ryan,	188 Elizabeth St., Derby.

FLORIDA.

Brevard, C. H. Racey, Waveland.

ILLINOIS.

Iroquois, J. L. Peacock, Sheldon.
Rock Island, D. M. Slottard, 12th Ave. and 17th St., Moline.

IOWA.

Clinton, D. L. Pascol, Grand Mound.
Pottawattamie, Dr. C. Engel, Crescent.

KANSAS.

Ness, Frank Lake, Ransom.

MASSACHUSETTS.

Norfolk, Orlando McKenzie, Norfolk.
" J. J. Blich, Wrentham.
" S. W. Fuller, East Milton.
Suffolk, Capt. W. J. Stone, 4 Tremont Row, Boston.
Worcester, B. H. Mosher, Athol.

MICHIGAN.

Berrien, W. A. Palmer, Buchanan.
Cass, Thomas Dewey, Dowagiac.
Hillsdale, C. A. Stone, Hillsdale.
Kalamazoo, C. E. Miller, Augusta.
Lake, John Trieber, Peacock.
Ottawa, W. H. Dunham, Spencer.

NEBRASKA.

Hall, E. C. Statler, Grand Island

NEW HAMPSHIRE.

Cheshire, S. C. Ellis, Keene.
Sullivan, G. A. Blake, Lempster.
" J. W. Davidson, Charlestown.

NEW JERSEY.

Hudson, A. W. Letts, 51 Newark St., Hoboken
Mercer, Edw. Vanderbilt, Dentzville, Trenton.
" Roland Mitchell, 739 Centre St., Trenton
" F. C. Wright, Trenton.
Monmouth, Dory-Hunt, Wanaque.
Morris, Joseph Pellet, Pompton Plains.
" Chas. W. Blake, Dover.
" Francis E. Cook, Butler.
" Calone Orr, Hibernia.
Somerset, G. E. Morris, Somerville.
Sussex, Isaac D. Williams, Branchville.
Union, A. H. Miller, Cranford.
" C. M. Hawkins, Roselle.
Warren, Jacob Young, Phillipsburg.
" Reuben Warner,

NEW YORK.

Albany, C. D. Johnson, Newtonville.
" Kenneth E. Bender, Albany.
" W. S. Swift, Voorheesville.

County.	Name of Warden.	Address.
Allegany,	G. A. Thomas,	Belvidere.
Broome,	John Sullivan,	Sanitaria Springs
"	R. R. Mathewson,	Binghamton.
Cayuga,	H. M. Haskell,	Weedsport.
Chemung,	Fred. Uhle,	Hendy Creek,
"	M. A. Baker,	Elmira.
Columbia,	A. B. Miller,	Jackson's Corners
Cortland,	James Edwards,	Cortland,
Dutchess,	A. B. Miller,	Jackson's Corners.
"	Chas. H. DeLong,	Pawling.
"	Jacob Tompkins,	Billings.
Erie,	Marvin H. Butler,	Morilla.
Essex,	W. H. Broughton,	Moriah.
Franklin,	Jas. Eccles,	St. Regis Falls.
Greene,	W. J. Soper,	Windham.
Hamilton,	David Aird, Jr.	Lake Pleasant.
Herkimer,	D. F. Sperry,	Old Forge.
Jefferson,	C. J. Smith,	Watertown.
"	A. C. Cornwall,	Alexandria Bay,
"	Jos. Northrup,	
Livingston	M. De La Vergne,	Lakeville.
"	K. S. Chamberlain,	Mt. Morris.
"	Henry Skinner,	Springwater.
"	Dr. J. W. Cowan,	Geneseo.
Montgomery,	Charles W. Scharf,	Canajoharie.
New York,	C. L. Meyer,	46 W. B'way, N.Y. City.
Oneida,	J. M. Scoville,	Clinton.
Onondaga,	James Lush,	Memphis.
Orange,	J. Hampton Kidd,	Newburgh.
"	Thomas Harris,	Port Jarvis.
Orleans,	J. H. Fearby,	E. Shelby.
Oswego,	J. E. Manning,	154 West Utica St. Oswego.
Putnam,	H. L. Brady,	Mahopac Falls.
Queens,	Gerard Van Nostrand,	Flushing, L. I.
"	W. S. Mygrant,	46 Elton Street, Brooklyn.
"	P. A. Geepel,	473 Grand Ave., Astoria, L. I.
"	L. B. Drowne,	119 Somers Street, Brooklyn.
"	Lewis C. Att,	Broad Channel Hotel, Rockaway, L. I.
Richmond,	Lewis Morris,	Port Richmond.
St. Lawrence,	Dr. B. W. Severance,	Gouverneur.
"	A. N. Clark,	Sevey.
Schenectady,	J. W. Furnside,	Schenectady.
Schoharie,	O. E. Eigen,	Sharon Springs.
Schuyler,	G. C. Fordham,	Watkins.
Suffolk,	F. J. Fellows,	Central Islip, L. I.
"	P. F. Tabor,	Orient, L. I.
Tioga,	Geo. Wood,	Owego.
Ulster,	M. A. De Vall,	The Corners.
"	Wm. S. Mead,	Woodstock.
Warren,	Geo. McEchron,	Glens Falls.
Washington,	C. L. Allen,	Sandy Hill.
"	J. E. Barber,	Dresden.
"	A. S. Temple,	Whitehall.
Westchester,	George Poth,	Pleasantville.
"	Chas. Seacor,	57 Pelham Road, New Rochelle.
"	M. W. Smith,	Croton Falls.
"	Ralph Gorham,	Mt. Kisco.
Yates,	B. L. Wren,	Penn Yan.
"	Seymour Poineer,	Branch Port.

OHIO.

Allen, S. W. Knisely, Lima.
Clark, Fred C. Ross, 169 W. Main St., Springfield.
Cuyahoga, A. W. Hitch, 161 Osborn St., Cleveland.
Erie, David Sutton, 418 Jackson St., Sandusky.
Franklin, Brook L. Terry, 208 Woodward Av., Columbus.
Fulton, L. C. Berry, Swanton.
Hamilton, W. C. Rippey, 4465 Eastern Ave., Cincinnati.
Knox, Grant Phillips, Mt. Vernon.
Lorain, T. J. Bates, Elyria.
Muskingum, Frank D. Abell, Zanesville.
Ottawa, Frank B. Shirley, Lakeside.
Scioto, J. F. Kelley, Portsmouth.
Stark, A. Dangeleisen, Massillon.

OKLAHOMA.

Kiowa and Comanche Nation, A. C. Cooper, Ft. Sill.

PENNSYLVANIA.			Augusta, Mont.,	H. Sherman,	Rear Warden.
County.	Name of Warden.	Address.	Austin, Minn.,	G. F. Baird,	"
Allegheny,	S. H. Allen,	Natrona.	Austin, Pa.,	W. S. Warner,	"
Beaver,	N. H. Covert,	Beaver Falls.	Boston, Mass.,	Capt. W. I. Stone,	"
"	W. R. Keefer,	"	Buffalo, N. Y.,	H. C. Gardiner,	"
Bradford,	Geo. B. Loop,	Sayre.	Cammal, Pa.,	B. A. Ovenshire,	"
Butler,	F. J. Forquer,	Murrinsville.	Champaign Co., O,	Hy. F. MacCracken	"
"	J. W. McGill,	Harrisville.	Urbana,	"	"
Cambria,	W. H. Lambert,	720 Coleman Ave.,	Charlestown, N. H.,	W. M. Buswell,	"
"	"	Johnstown.	Cheyenne, Wyo.,	J. Hennessy,	"
Cameron,	Harry Hemphill,	Emporium.	Choteau, Mont.,	G. A. Gorham,	"
Carbon,	Asa D. Hontz,	East Mauch Chunk.	Cincinnati, Ohio,	B. W. Morris,	"
Clarion,	Isaac Keener,	New Bethlehem.	Coudersport, Pa.,	I. L. Murphy,	"
Clinton,	M. C. Kepler,	Renovo.	Cresco, Iowa,	J. L. Platt,	"
"	Geo. L. Kepler,	"	Cross Village, Mich.,	Job Rohr,	"
"	R. T. Antes,	Pine Station	Davis, W. Va.,	J. Heltzen,	"
Crawford,	Jaasper Tillotson,	Tillotson.	Dowagiac, Mich.,	W. F. Hoyt,	"
"	Geo. T. Meyers,	Titusville.	East Mauch Chunk, Pa.,	E. F. Pry,	"
"	J. B. Lamb,	Buel.	Evansville, Ind.,	F. M. Gilbert,	"
Cumberland,	J. C. Gill,	Mechanicsburg.	Fontanet, Ind.,	W. H. Perry,	"
Delaware,	Walter Lusson,	Ardmore.	Ft. Wayne, Ind.,	W. L. Waltemarth	"
Elk,	D. R. Lobaugh,	Ridgway.	Great Falls, Mont.,	J. M. Gaunt,	"
Fayette,	Ely Cope,	Cadwallader.	Heron Lake, Minn.,	K. C. Buckeye,	"
Jefferson,	John Noll,	Sykesville.	Holidays'b'g, Pa.,	T. J. Hemphill	"
Juniata,	Clifford Singer,	Oakland Mills.	Hopkinsville, Ky.,	Hunter Wood,	"
"	Ezra Phillips,	McAlesterville.	Indianapolis, Ind.,	Joseph E. Bell,	"
Lackawanna,	Wm. Weir,	Moosic.	Jerome, Ariz.,	Dr. L. A. Hawkins,	"
"	Wm. Major,	"	Johnsonburg, Pa.,	W. J. Stebbins,	"
"	Frank A. Tarlox,	Wimmers.	Kalispell, Mont.,	John Eakright,	"
Lycoming,	Jas. J. Brennan,	Oval.	Keene, N. H.,	F. P. Beedle,	"
"	B. D. Kurtz,	Cammal.	Kingfisher, Okla.,	A. C. Ambrose,	"
McKean,	C. A. Duke,	Duke Center.	Lake Co., Ind.,	Dr. R. C. Mackey,	"
"	L. P. Fessenden,	Granere.	Lawton, O. T.,	Marion Miller,	"
"	Wm. Holsinger,	Stickney.	Lincoln, Neb.,	A. J. Sawyer,	"
Montgomery,	L. C. Parsons,	Academy.	Logansport, Ind.,	E. B. McConnell,	"
Northumber-	G. W. Roher,	505 Anthracite St., Shamokin.	Ludington, Mich.,	G. R. Cartier,	"
land,	Samuel Sundy,	Lebo.	McElhattan, Pa.,	A. B. Winchester,	"
Perry,	Ira Murphy,	Coudersport.	Mechanicsburg, Pa.,	Dr. J. H. Swartz,	"
Potter,	Wiley Barrows,	Austin.	Minturn, Colo.,	A. B. Walter,	"
"	Chas. Barrows,	Austin.	Morgantown, W. Va.,	B. S. White,	"
"	E. B. Beaumont, Jr.,	Lawrenceville	New Albany, Ind.,	Dr. J. F. Weathers,	"
Tioga,	G. H. Simmons,	Westfield.	New Bethlehem, Pa.,	Isaac Keener,	"
"	G. D. Benedict,	Pleasantville.	Oklahoma City O. T.,	N. F. Gates,	"
Venango,	F. P. Sweet,	Goodwill Hill.	Penn Yan, N. Y.,	Dr. H. R. Phillips,	"
Warren,	Nelson Holmes,	Cornplanter.	Phillips, Wis.,	F. K. Randall,	"
"	Cyrus Walter,	Tunkhannock.	Princeton, Ind.,	H. A. Yeager,	"
Wyoming,	"	"	Reynoldsville, Pa.,	C. F. Hoffman,	"
TENNESSEE.			Ridgway, Pa.,	T. J. Maxwell,	"
Madison,	H. T. Rushing,	Jackson.	Rochester, N. H.,	Gustave Andreas,	"
Montgomery,	P. W. Humphrey,	Clarksville.	" N. Y.,	C. H. McChesney	"
Robertson,	C. C. Bell,	Springfield.	St. Paul, Minn.,	O. T. Denny,	"
Stewart,	John H. Lory,	Bear Spring.	St. Thomas, Ont.,	L. J. Hall,	"
Sumner,	W. G. Harris,	Gallatin.	Schenectady, N. Y.,	J. W. Furnside,	"
UTAH.			Seattle, Wash.,	M. Kelly,	"
Washington,	S. C. Goddard.	New Harmony.	Syracuse, N. Y.,	C. C. Truesdell,	"
"	J. A. Thornton,	Pinto.	Terre Haute, Ind.,	C. F. Thiede,	"
VERMONT.			The Dalles, Ore.,	C. B. Cushing,	"
Essex,	H. S. Lund,	Granby.	Two Harb'rs, Minn.,	T. D. Budd,	"
Orleans,	E. G. Moulton,	Derby Line.	Walden, N. Y.,	J. W. Reid,	"
Rutland,	Wm. J. Liddle,	Box 281, Fair Haven	Wichita, Kas.,	Gerald Volk,	"
Windsor,	F. A. Tarbell,	West Bridgewater.	Winona, Minn.,	C. M. Morse,	"
VIRGINIA.			LIFE MEMBERS OF THE LEAGUE.		
Henrico,	W. J. Lynham,	412 W. Marshall,	Anderson, A. A.,	80 W. 40th St.,	New York City.
"	"	Richmond.	Beard, D. C.,	204 Amity St.,	Flushing, L. I.
King & Queen,	R. D. Bates,	Newtown.	Blackstone, Lorenzo,	Norwich, Conn.	
King William,	N. H. Montague,	Palls.	Buzzacott, Francis F.,	Chicago, Ill.	
Louisa,	J. P. Harris,	Applegrove.	Brown, J. Stanford,	489 Fifth Ave.,	New York City.
Mecklenburg,	J. H. Ogburn,	South Hill.	Butler, C. E.,	Jerome, Ariz.	
Smythe,	J. M. Hughes,	Chatham Hill.	Carey, Hon. H. W.,	Eastlake, Mich.	
WASHINGTON.			Carnegie, Andrew,	2d, Fernandina, Fla.	
Okanogan,	James West,	Methow.	Carnegie, George,	Fernandina, Fla.	
Stevens,	Jacob Martin,	Newport.	Carnegie, Morris,	Fernandina, Fla.	
"	L. H. Lee,	Northport.	Corbin, Austin,	192 Broadway,	New York City.
Yakima,	J. Brachmann,	N. Yakima.	Dickinson, E. H.,	Moosehead Lake, Me.	
WYOMING.			Edgell, G. S.,	192 Broadway,	New York City.
Carbon.	Kirk Dyer,	Medicine Bow.	Ellis, W. D.,	136 W. 72d St.,	New York City.
Fremont,	Nelson Yarnall,	Dubois.	Fearing, D. B.,	Newport, R. I.	
Laramie,	Martin Breither,	Cheyenne.	Ferry, C. H.,	1720 Old Colony Bldg.,	Chicago, Ill.
Uinta,	{ S. N. Leek,	{ Jackson.	Ferry, Mansfield,	183 Lincoln Park Boulevard,	Chicago, Ill.
"	{ F. L. Peterson,	{	Fraser, A. V.,	478 Greenwich St.,	New York City.
LOCAL CHAPTERS.			Gilbert, Clinton,	2 Wall St.,	New York City.
Albert Lea, Minn.,	H. A. Morgan,	Rear Warden.	Hudson, E. J.,	33 E. 35th St.,	Bayonne, N. J.
Anadarka, O. T.,	Bert Smith,	"	McClure, A. J.,	158 State St.,	Albany, N. Y.
Angelica, N. Y.,	C. A. Lathrop,	"	Mershon, W. B.,	Saginaw, Mich.	
			Miller, F. G.,	108 Clinton St.,	Defiance, O.

Morton, Hon. Levi P., 681 Fifth Ave., New York City.
 Nesbitt, A. G., Maple St., Kingston, Pa.
 O'Connor, Col. J. C., 24 E. 33d St., New York City.
 Pierson, Gen. J. F., 20 W. 52d St., New York City.
 Prescott, A. L., 90 W. Broadway, New York City.
 Rice, A. F., 155 Pennington Ave., Passaic, N. J.
 Seton, E. T., 80 W. 40th St., New York City.
 Seymour, J. H., 35 Wall St., New York City.
 Smith, E. B., Bourse Bldg., Philadelphia, Pa.
 Smith, W. H., Bryn Mawr, Pa.
 Thompson, J. Walter, Times Bldg., New York City.
 Towne, E. S., Care of National Blank Book Co., Holyoke, Mass.
 Underwood, W. L., 52 Fulton St., Boston, Mass.
 Valentine, Dr. W. A., 5 W. 35th St., New York City.
 H. Williams, Box 156, Butte, Mont.

DISCOUNTS TO LEAGUE MEMBERS.

The following firms have agreed to give members of the L. A. S. a discount of 2 per cent. to 10 per cent. on all goods bought of them. In ordering please give L. A. S. number:

Syracuse Arms Co., Syracuse, N. Y. Guns.
 Davenport Fire Arms Co., Norwich, Conn. Shot guns, rifles.
 Gundlach Optical Co., Rochester, N. Y. Photographic goods.
 Blair Camera Co., Rochester, N. Y. Photographic goods
 James Acheson, Talbot St., St. Thomas, Ontario, Sporting goods.

WANT BETTER GAME LAWS.

Here is a copy of a circular letter which the Chief Warden of one Division of the L. A. S., is sending to all members of his State Legislature:

Dear Sir:—

There will be introduced, during the present session of your honorable body, a bill providing for a State officer to be known as Fish and Game Warden, whose duty shall be the enforcement of the laws of the State for the protection of our fish, game, and song birds; also another bill requiring resident hunters to pay a small license fee, when hunting off their own premises, and making a slight change in the present law as to jurisdiction of courts, perhaps making a close season on rabbits, and possibly some other changes.

The purpose of this letter is to apprise you, in advance, of the legislation that will be asked for and, if possible, to enlist your interest in these bills. The measure is not for the benefit of any special class but for all citizens alike; for the land owner who wants protection from trespassers; and for dwellers in cities and towns, who like a day off now and then, to fish or hunt, few of whom can afford the time or means to go to other States for such recreation. Our present laws are good, but do not protect because we have no system of enforcement.

Our people are beginning to realize that we, as well as other States around us, must take prompt and effective action in this matter or it will be but a short time until Ken-

tucky, the native home of small game, fish and song birds, will know these things no more.

The Virginia deer and the wild turkey that once abounded and could be had for the taking, will have become a memory. The quail and the ruffed grouse that were as gentle as chickens and much more plentiful, will be represented by a few lonely cocks to whistle and drum requiem to their departed kind. Our fish will be reduced to German carp and mud cat; and for birds, we shall have only the English sparrow, a foreigner on our shores, who merely caricatures the music of our own beautiful and useful birds.

It is apparent to every thoughtful mind that birds are of incalculable value to the farms of the country; and that fish and game are also beneficial in many ways, and, when taken in season and by proper methods, could be made a source of revenue to the State. It would be a reflection on your intelligence to argue these points with you, and I only hope by these suggestions to impress on you the importance of the bill and to secure for it your favorable consideration. Trusting you may not let other matters crowd it from your calendar, I am,

Yours respectfully,

Chief Warden — Division L. A. S.

This must certainly prove an effective method of securing favorable consideration of the subject in advance, and I heartily commend the plan to League officers in other States.—EDITOR.

County Game Warden J. A. Uhlig a short time ago made complaint against C. L. Gimmel for putting sawdust in the stream at his mill. Gimmel was fined \$100 in the Justice Court. He appealed to the Superior Court, but dropped the case and paid up. It cost him about \$160 altogether. Uhlig also caught a young fellow with a quail in his bag a few days ago. This fellow paid \$10 and costs.

F. S. Merrill, Spokane, Wash.

Burd Hunter—Had great luck to-day.

Archie Gunter—Bag anything?

Burd Hunter—No, but I brought all the dogs back alive.—Pennsylvania Punch Bowl.

I think yours is the best sportsmen's journal printed. I read several others, but RECREATION beats them all.

J. A. George, Eastlake, Mich.

Mrs. Newbride—Do you keep a cook?

Mrs. Oldwed—No! Does anybody?—Exchange.

FORESTRY.

It takes 30 years to grow a tree and 30 minutes to cut it down and destroy it.

THE ADIRONDACK PROBLEM.

The following editorial, which recently appeared in *The Independent*, clearly and forcibly presents the conditions of forestry problems in the State of New York, accentuating the position that forestry and sport do not necessarily exclude each other, but can and should go together as they do in the forests of France and Germany.

From the report of the Forest Commission of 1903, it appears that nearly 800,000 acres of Adirondack lands are held by about 60 owners, or by clubs, for game preserves. These holdings vary from 300 to 79,000 acres in a single block. They do not prevent so much the acquiring of homes in these mountainous regions, which are hardly intended for homes, but they curtail the public use of the forest. Professor Fernow, who advocated, in his "Economics of Forestry," the occupancy by private owners, and even the creation of a class of landed proprietors, as the only method in sight for immediately protecting the forest from devastating fires and from timber thieves, now says that he must modify his judgment to this extent, that any such occupancy tends to create a class of those who do not care for the public weal, but for private pleasure, to the exclusion of the people. He thinks that gradually, and perhaps imperceptibly, an aristocratic spirit will be developed inimical to democratic institutions. In the third place, Dr. Fernow finds that the attitude of the State toward its own holdings is changed. At first the reservation of Adirondack lands in the hands of the State was based on economic questions of timber supply and water protection, but it is now perverted into the idea of establishing a great pleasure ground. He thinks this to be the present attitude of our legislators, shown in their recent action concerning the work of Cornell university.

"While there is no objection to having such a large area devoted to pleasure, if accessible to all the people, and used in a proper way, it is not necessary, and it is economically unsound, to exclude the management of these forests from economic ends."

The position of the Professor is that of honest democracy. He has advocated large forest holdings in private hands, and saw no objection to corporations controlling the timber supply; but he deprecates these vast holdings for mere pleasure. He holds it to be the first object of the State to have the great forest region as a source of revenue,

including the preservation of water supply and whatever secondary benefits may be derived thereby to the State. To withdraw the Adirondacks from the productive industries he denounces as un-American.

That 60 owners, whether private individuals or clubs, should hold 800,000 acres out of the reach of the people is an innovation that can not be denounced in too strong terms. It is certain to create in this country a vulgar edition of English landlordism, and it is a catching spirit. Sooner or later, it must breed the same sort of antagonism which exists between the tenants and poachers of Ireland and their landlords. There will be trespassing; and there will be a growing sentiment of lawlessness, because law will be on the side of the aristocrats. The clash will involve more or less of brutality and assassination, the shooting of game wardens, and, finally, of landlords themselves. Indeed, this antagonism is already observable and has threatened life as in the old Barnburner days.

It was hoped that the establishment of a State College of Forestry, in connection with Cornell university, and the placing of the Adirondacks largely in its control, would solve the problem, which had long been a serious one to the State. It is to be regretted that a misunderstanding has arisen and the State withdrawn its appropriation for this college. That this college moved on lines antagonistic to the popular welfare does not seem to be proven. Governor Hill, in 1890, said to the Legislature that he believed "the Adirondack forest might be made a source of great revenue to the State, rather than an expense and a burden." Governor Flower, in 1892, said that "eventually the State preserve ought to pay the expense of its maintenance, by the judicious sale of timber and the leasing of small parcels of land, to individuals, for the establishment of small homes, under proper regulations." He added, in 1894:

"Following the ideas and suggestions which have been promulgated by forestry experts, we intend that our forest shall not only protect our water supply, and thereby our agricultural and commercial interests, and furnish summer homes and sanitariums for the people, but that they shall, at the same time, yield a revenue which shall pay the cost of maintenance and a handsome sum besides."

Governor Black was of the same mind. He thought that the time would come when

the State would sell timber to the lumbermen, spruce to the pulp mills, reap a large revenue for itself, still retain the woods open to the public, while protecting the sources of water, and increasing the yield under intelligent cultivation. It was along this line that he urged the placing of this section of our State in charge of Cornell university. President Roosevelt had his first training in forestry as governor of New York State. In 1903, in an address to foresters, he said:

"The object is not to preserve the forests simply because they are beautiful, but the primary object is the making of a prosperous home." This economic conception of the whole question is the correct one. The useful and the beautiful need never be divorced.

The College of Forestry for working out these economic conceptions, which really date back to Governor Horatio Seymour, was one of the wisest institutions ever created in our State. The Constitutional Convention of 1894 prohibited the cutting of wood on the forest preserves. This was to turn the whole Adirondack woods into an everlasting wilderness, obliterating the economic conception of the problem. Without violating the Constitution, it was thought that Cornell university might be allowed to conduct forestry experiments on a purchase of land adjacent to the preserve for 30 years. It was provided that the university might "plant, cut, raise and sell timber, with a view to obtaining and imparting knowledge concerning the scientific management and use of forests, their regulation and administration, the harvesting and reproduction of wood crops and earning a revenue therefrom."

The College of Forestry was made a branch of Cornell university, and given a working capital of \$30,000. It was supposed that the sale of wood might enlarge this capital, none of the profits accruing to the university. The working of this college brought it immediately under the condemnation of its neighbors. If the economic conception of the Adirondacks were allowed thus to work itself out, there must be an end of landlordism, sooner or later. The result was a violent attack, with a good deal of misapprehension and misrepresentation, followed by a withdrawal of State patronage. The college is closed. The State of New York, through its Constitution, unwittingly made more than a million acres of the Adirondacks a permanent park for sportsmen. This was a bid for wealthy persons to secure as large areas as possible for their private uses, and they have done it. It was impossible to judge reasonably of the College of Forestry from an experiment lasting less than 3 years. It was expressly organized by the

Legislature for a 30 years' test. It needs but common knowledge of forestry to understand that in less time an economic experiment of this kind could not be worked out. As matters now stand, the Adirondacks are given up to private exploitation. The forest question, as far as New York is concerned, has ceased to be one of economic import, and has become one of pleasure alone. Professor Fernow, who had charge of the college, certainly has the entire confidence of experts in this country and in Europe. He was Chief of the Division of Forestry at Washington when called to be Director of our State College. Can we afford to allow matters to rest where they are? Shall we create in our country a spirit of outlawry to compete with an unwelcome development of landlordism?

BALSAM FOR PULP.

The importance of finding a satisfactory substitute for spruce for the manufacture of paper pulp led to a commercial study of the balsam fir, which Mr. Raphael G. Zon, of the Bureau of Forestry, has just concluded.

The rapid disappearance of spruce, the best tree in the North woods for the manufacture of pulp, has forced pulp makers to use more and more balsam, and has brought that tree, once despised and neglected, into an important place. Four years ago practically no balsam was used by pulp manufacturers, many of whom are now using 25 to 50 per cent of it. The quantity of balsam used depends entirely on the spruce supply near where the different mills are located. The smaller the quantity of spruce available the greater is the quantity of balsam used.

Pulp manufacturers find balsam the best substitute for spruce which can be found in the North woods. Other trees might serve well for paper pulp, but they are not native to the country where the mills are located. Pulp mills are enormously heavy and expensive, and the wood must be brought to them; they can not be taken to the wood. The pulp man, therefore, in his choice of a substitute for his diminishing supply of spruce, is confined to the few species that grow in association with spruce, and of these species balsam is at once the most abundant and the most promising.

The present method of making pulp out of balsam is to grind it or treat it with chemicals along with spruce. The results are not satisfactory. Balsam mixed with spruce produces an inferior grade of pulp. Mr. Zon suggests that it would be much better if balsam were handled independently of spruce. The balsam fibers are not nearly so tough and strong as those of spruce, and

the pressure of the grinders which are adjoined for spruce fibers is too powerful for the fibers of balsam, as they are torn and weakened. For the same reason the chemicals used in the treatment of spruce fibers weaken and dissolve the fibers of balsam when used in the same strength. Examples of what can be done with balsam in the manufacture of paper are found in France, where the tree is made to produce good book papers. There not only the main trunk, but even the top of the tree is used.

The silvicultural features of the balsam are related by Mr. Zon, who has studied the tree carefully throughout its range, but particularly in Maine and the Adirondacks. Spruce has been cut for many years, while balsam has scarcely been cut at all; hence balsam has taken the place of and is crowding out the spruce. This change in species in the North woods is hastened by the great superiority of balsam as a seed tree, for balsam bears seeds every year, while the spruce seeds only once in 7 years. These conditions make it apparent how desirable it is that pulp manufacturers should use balsam wherever possible, for in doing so they not only lessen the drain on the limited quantity of spruce left, but they give the tree a chance to grow and reproduce itself. This point Mr. Zon brings out forcefully.

PACIFIC COAST TIMBER SUPPLIES.

It was estimated that the cut of lumber and shingles in the 3 Pacific coast States during the census year was little less than 4 billion feet, board measure; and the timber standing and ready for the axe was placed at about 620 billion feet. The ready mathematician would complacently figure from this that there are over 150 years of supply in sight, and since there must be some new growth on the cut over areas, we could treat this supply for the present at least as practically inexhaustible.

This calculation is based on the assumption that the annual cut remains the same, which is far from the truth. With the growth of the community there is, of course, an increase in the use of materials; but even this allowance of increased cut does not in any way permit us to forecast the future; for the timber supplies are by no means used locally. Even now, of the present cut we can fairly estimate that only one-quarter is used by the resident population 2 (!) million people using lumber at the rate of 500 feet B. M. per capita. Three-quarters of the cut is exported, not only to foreign parts by water, but by rail to Eastern markets. The shipments of Pacific coast lumber to the Mississippi valley, and even farther East, have been growing at an enormous rate, and as the supplies

of the Atlantic forests are giving out, the Western shipments will grow at a rate not indicated in the past history of trade development.

The only way in which we can discuss any of our resources is with reference to the whole country. The figuring should proceed about as follows: We cut in the whole country at present a round 30 billion feet of coniferous material such as the Pacific coast forest can alone furnish. According to the census our consumption doubles in about 20 years. That means that each year 1,500,000,000 feet increase in the cut is necessary. At this rate, the enormous supplies of the Pacific coast are not sufficient to furnish the requirements of the United States for 15 years. Assuming, on the basis of other calculations, that the Eastern supplies can fill the bill for 15 years, it is evident that less than 30 years will see the end of the magnificent Pacific coast forests.

There is, however, one fact that will presently, and should now, add to the supply. The estimates of standing timber are based on the present standard of the marketable log which is unnecessarily extravagant. It is probable that with decrease in supply and consequent increase in price the size of the log which is acceptable to the mill man will come down to that of Eastern standards. The Pacific coast supplies may then be doubled.

"Ma, kin I go over an' play wid Micky Hoolihan?"

"Naw. Yez know we don't have nothin' to do wid thim Hoolihans."

"Den lemme go over an' kick de stuffin' outer him."—Exchange.

I have just finished reading the December number of RECREATION and find it the best sportsmen's magazine I ever saw.

H. J. Henry, MacDougall, N. Y.

Harker—You say the mimic was good?

Barker—Indeed he was. When he made a noise like an automobile everyone jumped.
—Chicago News.

It is simply a snap to get subscribers for RECREATION. It took me only a few hours to get this list of 40 subscriptions.

C. E. Shultis, Waukegan, Ills.

I send you herewith \$1, for which please send the "best on earth" to J. B. Monroe, Kipp, Montana, for one year.

H. H. Garr, Columbia Falls, Mont.

RECREATION is a peach. I could not do without it.

Murray Reid, Lima, O.

PURE AND IMPURE FOODS.

Edited by C. F. LANGWORTHY, PH.D.

Author of "On Citraconic, Itaconic and Mesaconic Acids," "Fish as Food," etc.

"What a Man Eats He Is."

WHOLESALE PIE-MAKING.

In large cities pies of all sorts have long been made for sale by bakers and confectioners. A more recent development is that of pie-making on a large scale in bakeries or factories given up entirely to this class of goods. Wholesale pie-making in New York was recently described in the New York Tribune.

The maker of old fashioned domestic pies cannot easily conceive of a system by which a barrel of apples and a barrel of flour can, figuratively speaking, start at one end of a long bench and leave the other end 1,000 or less finished pies; but the system is in use in all the large pie bakeries. Several men are required in a large bakery to mix dough, roll the crust, and cut it off in portions of suitable size for the bottom crusts of pies. These pieces are passed on to men who roll the bottom crusts and place them in the pans, which are arranged in large wooden trays, heaped one on another in stacks as tall as a man. The stacks of trays are then hauled to the filler.

The baking force goes on duty at 10 o'clock at night. During the day girls have been paring and slicing apples and pumpkins, and the foreman has been spicing and sweetening the cooked fruit or mince meat, the custards, and other prepared filling, which have also been cooked by steam in large stone stew vats. When the bakers go on duty, the prepared filling is in place in front of the great doughboard in tubs holding half a barrel each, and the stewed apples in full sized barrels.

The pies, whether 10,000 or 15,000 a night, in the bakery visited, were all filled by one man. With a long handled cup similar to that used in dipping milk from a can, he stands over a tub of stewed pumpkin, mince or custard and fills pies so rapidly that all of one's time is required to bring the trays holding the pies to his side and that of another to take them away. Nearly a hundred pies a minute looks like an impossibility, but he sends them to the men who put on the top crusts and the meringues at that rate for many minutes at a stretch.

The filled pies go in the big wooden trays to the men who cover them with the top crust, or who add the meringue, using for this purpose a conical canvas bag open at the smaller end, out of which they squeeze the frosting on the fancy pies.

The top crust pies go to the drawplate

oven, and the pumpkin, custard, and meringue pies and the tarts to the older fashioned ovens, where they are handled with long, slender shovels. Out of the large drawplate ovens is pulled with a steel hook a plate of iron half an inch thick or more, already heated. The thermometer in front of the oven, enclosed in a recess covered with glass, shows a temperature of 550 deg. F. About 100 pies at a time are placed on this plate and it is pushed into the oven. The hands of a dummy clock at the side are set to indicate the moment at which the baking will be finished. Another plate is then drawn out and filled and the proceeding is repeated until the night's work is done. The pies, after baking, go into wooden trays as before, and are taken to the shipping room, where they are counted and loaded into the wagons for delivery.

About 40 girls, boys and men by this system produce 10,000 to 15,000 pies a day. They use about 15 barrels of flour, 6 to 10 barrels of apples, 9 or 10 half-barrels of mince meat, nearly as much stewed pumpkin, perhaps as much each of other fruits and custards, a barrel or more of lard, about 2 barrels of sugar, and large quantities of spice. The shortening, sweetening and spicing are carefully and accurately weighed in exact proportions. The baking is timed to suit the constant temperature, which is maintained so that there is absolute uniformity, and all the mixing and flavoring, while done on a large scale, are so conducted as to insure a uniform quality.

Contrary to all popular notions on the subject, the wholesale manufacture of pies in a modern establishment is thoroughly clean, and in the pie bakery visited every precaution was taken to insure clean materials and utensils, as well as hygienic surroundings; nor was the personal cleanliness of the employees neglected.

A FEAST FOR THE POOR OF CALCUTTA.

The feeding of the poor of Calcutta at the time of the coronation of King Edward VII. is described by an eye witness in effect as follows:

The feeding of the poor we found a most interesting sight. Between 40,000 and 45,000 Hindoos and Mohammedans, principally beggars and scavengers, but also ghari drivers and khalassiger, or boatmen, were fed. A part of the Maidan, large enough

to seat these people, was fenced in with native mats, and then divided into blocks, 225x75 feet, which would each accommodate 1,000 people, seated on the ground. Twenty of the enclosures were reserved for the Hindoos and 10 for the Mohammedans, as only 30,000 were expected at first, and the 15,000 extra unexpected had to stand or crowd as best they could. The 2 sets of blocks were 300 feet apart, as, of course, they must observe the rules of the religion and not have even the shadow of an infidel cast on their foods. At 10 o'clock in the morning drums began to beat and the poor, lame, blind and halt came forth in hundreds from all parts of Calcutta and its suburbs.

It was the most amazing collection of people one could possibly behold, in the greatest variety of costume, or no costume, imaginable. The committee for receiving them had no trouble with the Mohammedans as soon as they were made to understand the whereabouts of their enclosures, but there was much trouble and vexation with the Hindoos, for one caste absolutely refused to sit near another. The Brahmin, or priest caste, insisted on a separate enclosure for themselves, and got it! It was like a huge company of white clad blackbirds, fluttering about, changing places, lighting and flying off and all the time keeping up an appalling chatter. They were at last seated, the whole 20,000, but in spite of the care of the attendants some of the castes got mixed. In one place we were shown a lot of municipal scavengers next or opposite some Sadhus, religious beggars of the Hindoos, covered and smeared with mud and saffron; and farther along, a number of chamars, tanners and Domes, the caste who carry dead bodies, sitting beside some interesting looking snake charmers in long, yellow drapery and huge turbans.

After all were seated, there were several hours for them to wait, but waiting is an accomplishment peculiar to the native of India, and even small children did it with patience. The cooking must have been a gigantic affair. We were told that everything given to the Mohammedans was cooked the night before, but that for the 30,000 Hindoos it had taken fully 5 days to prepare the food. Sheds had been put up inside the matting fence, and there all the food was stored. Each block was under the care of a committee of 3, with 30 assistants. The Hindoos had banana leaves for plates and the Mohammedans earthen plates, while all of them had earthenware drinking cups. We were told also that 2½ miles of piping for filtered water had been laid, and large earthen jars were placed at the corners of each enclosure.

The menus interested us greatly. For the Mohammedans there were paloe, rice,

ghee (rendered butter), korma, a brown curry, and sweets; pan, which is betel nut and lime; and cigarettes and tea; and for the Hindoos, toochis, or cakes, vegetable curries, dahi or curd, sweets, pan, and tea. It was difficult to learn the quantities of the menu, but according to the Calcutta Statesman of the 28th 24,000 pounds of flour, 10,000 pounds of ghee, 32,000 pounds of potatoes, 16,000 pounds of curry, and 1,500 cabbages were used for the Hindoos only; and the meat alone for the Mohammedans cost 1,000 rupees, equal to about \$465.

The whole feast went smoothly from beginning to end, and as each one left the enclosure he was made happy by the present of a bright, new 2-anna piece, fresh from the mint, which would mean 4 cents of American money, quite a fortune to some of them, as it can be divided into 24 pie, the smallest coin of Indian currency.

THE COST OF LIVING.

From figures showing the income and expenditures, in the year 1901, of 2,567 families in 33 States, representing the industrial centers of this country, the U. S. Bureau of Labor has deducted some interesting and instructive figures. The basis of selection was that the head of the family must be a wage worker or a salaried man earning not over \$1,200 during the year, and must be able to give information in regard to his expenditures in detail. The average income of these families for the year, from all sources was \$827.19. The average expenditure for all purposes was \$768.54, and the average expenditure for food was \$326.90 per family, or 42.54 per cent. of the average expenditure for all purposes.

The average cost of food per family in 1890 was \$318.20. In 1896, which was, according to figures gathered by the Bureau, the year of lowest prices for food stuffs, it fell to \$296.76, and in 1902 reached the highest point of the period included in the comparison, being \$344.61, an increase of 61.1 per cent. over 1896 or of 10.9 per cent. when compared with the average for the 10-year period of 1890 to 1899.

The family expenditures for articles other than food in 1901 represent 57.46 per cent. of the income. Certain of these expenditures representing 14.51 per cent. of the total, such as payments on principal and interest of mortgages, taxes, insurance, fees, charity, amusements, etc., are from their nature affected only indirectly and in slight degree by any rise or fall in prices. Miscellaneous purposes, not reported, for which, from their character, no prices are obtainable, made up 5.87 per cent., and rent, for which also no prices for the several years are available, made up 12.95 per cent. of the total expenditure.

The remaining classes of family expenditure, 24.13 per cent. of all, consist of clothing, 14.04 per cent; fuel and lighting, 5.25 per cent.; furniture and utensils, 3.42 per cent., and tobacco, 1.42 per cent. For these no retail prices covering a series of years are available, but accepting as true of wholesale and retail prices here what this investigation has found true in the case of food, namely, that retail prices rise and fall more slowly and in smaller degree than wholesale prices, an examination of the relative wholesale prices of these classes or articles, as recorded in connection with earlier work of the Bureau of Labor, leads to the conclusion that the retail prices of these articles, as a whole, in 1902 could have been little, if at all, above the level indicated by food.

"It is apparently a safe and conservative conclusion, therefore, that the increase in the cost of living, as a whole, in 1902, when compared with the year of lowest prices, was not over 16.1 per cent., the figure given above as the increase in the cost of food as shown by this investigation. This assumes, of course, always the purchase of the same articles and the same quantities in years of low prices, low wages, and more or less irregular employment, and in years of higher prices, higher wages, and steady employment."

POTTED AND CANNED POULTRY.

The meat for these goods is prepared in essentially the same way as if it were to be used at once, and is then treated much as any other canned meat product, the object being to sterilize the can contents and exclude the air, with the micro-organisms always present in it. The prepared poultry flesh is placed in suitable vessels, tin cans being almost always used instead of glass or earthenware jars, as the cans are stronger and can be more readily closed to exclude the air completely. The tins are sealed save for a small hole in the cover and heated until the contents are sterilized. In the large American factories steam retorts are generally used for the sterilizing process but sometimes the cans are heated in water or in a salt bath. The small hole in the cover is closed with a drop of solder while the cans are hot and full of steam. The cans are left for some days and then tested by striking the head with a wooden mallet. If it sinks gradually, sterilization is considered satisfactory; if, however, the head of the can is elastic and rises back or swells it is an indication that some gas has been formed in the can and that sterilization is not complete. Such cans, called "swells" should be rejected, but fraudulent firms sometimes have a second hole punched in such bulging cans, and soldered after the

swelling has gone down. The second hole betrays this practice to the careful observer. If sterilization is not complete there is, of course, danger of decomposition and its attendant evils. Another possible but slight danger is that of poisoning from improper tin and solder, but this is not so great with meats as with fruits and vegetables in which the acids of the juice aid in the formation of dangerous substances. There is no reason why canned poultry, properly put up, should not be just as healthful as fresh, for which it is often a most convenient substitute.

JAPANESE TERRAPIN.

The United States Fish Commission, it is said, has sent an expert to Japan for the purpose of studying terrapin culture as practiced in that country, where they seem to have succeeded in raising the turtles by artificial means. It is true that the Japanese terrapin is not the same species as the sort eaten in the United States, but its habits are similar and there is reason to suppose that, like methods of culture might be successful in the United States.

The matter is of no small importance, as the American terrapin is on the verge of extinction. It used to be numerous, especially in the neighborhood of the Chesapeake; and in 1850 diamond backs sold for 12½ cents apiece. In colonial times terrapins were so cheap that slaves complained they were given them too often. Terrapins have been hunted almost to extermination, and at the present time they sell as high as \$60 a dozen.

The Japanese species, which is said to be equal to the American in flavor, is known as the "suppon," and, like the American terrapin, it is an inhabitant of tidal rivers and salt marshes. Shallow, artificial ponds, with muddy bottoms, are employed for raising purposes, with a low fence to prevent the turtles from escaping. At laying time, in early summer, the females climb out on the bank, scratch a shallow hole and deposit their eggs, finally covering them and leaving them to be hatched by the heat of the sun. Nets are spread to prevent birds from digging up the eggs.

Analysis of American terrapin shows that the flesh ranks with other meats in food value, containing some 21 per cent nitrogenous material and 4 per cent fat. Terrapin is prized, however, more as a delicacy and on account of its peculiar and agreeable flavor than on account of the nutritive material which it supplies.

RECREATION is the best thing of the kind I ever saw.

J. B. Fowler, Colorado Springs, Colo.

PUBLISHER'S NOTES.

MARBLE CLEANING ROD.

The Marble Safety Axe Co., Gladstone, Mich., makes one of the most practical and effective shot gun cleaning rods I have ever used. The rod is hollow, and has a steel rod running through it, with a wedge in the lower end and a lever on the upper end. The ball attached to the lower end of the rod is split in 4 equal parts, and is covered with a thick bed of short brass wire. Then the ball is inserted in the gun the user grips the lever so that the ball separates into 4 parts, and presses against the inner surface of the barrel with a greater or less degree of force, at the will of the person using the rod.

Some time ago I used some unusually soft shot in a fine gun, and the barrels were badly leaded. I went at them with one of these Marble cleaning rods and in 5 minutes had both barrels as clean and bright as when they came from the shop. The brass wire being softer than the steel in the barrel does not scratch nor mar it in the least. Every shot gun user in the country should have a Marble Safety Cleaning Rod.

When writing for this instrument, please mention RECREATION.

PROCTOR PLAYHOUSES.

During the investigations of the newly appointed Fire Commissioner, none of the theatres controlled by Mr. F. F. Proctor, the Fifth Avenue, 23d Street, 58th Street or 125th Street, has been mentioned as requiring any additional precautions. The Proctor plan appeals particularly to matinee audiences of women and children, and this has made Mr. Proctor additionally cautious in providing for any emergency. Not alone are the ushers and the other members of the house staff given weekly drills in fighting fire and handling crowds, but the stages are kept in such perfect condition, and the lighting equipment is so carefully watched, that a catastrophe like that which occurred in Chicago would be absolutely impossible at any Proctor house. In place of trusting to untried fire extinguishers to save the scenery from damage from water, the stage force has instructions to turn on the hose at the slightest appearance of danger, no matter how much scenery may be ruined. Had a similar rule been enforced at the Iroquois Theatre, the terrible loss of life would have never been recorded.

A GOOD HUNTING KNIFE.

The Press Button Knife, advertised in RECREATION and handled by the Novelty Knife

Co., 426 East 52d street, New York city, is one of the most useful and valuable articles put on the market for the benefit of sportsmen, in recent years. This hunting knife has a 4 inch blade, a buck horn handle and is built for business. The finest razor steel is used in the blades of all these knives, and the press button principle, on which they are built, can never be appreciated by anyone without practical experience in using it. Every man who goes into the woods for any purpose, whether for hunting, fishing, prospecting, surveying, or merely camping, should have one of these knives, and I am sure every man who may buy one will thank me for having called his attention to it.

This big knife sells at \$1, and is worth \$5 to any man who needs it. When open, the blade is locked and can not close on your hand. When closed it is locked and can not open in your pocket, as other knives frequently do. Write for circular or, better still, order a knife, and mention RECREATION.

Montclair, N. J.

J. R. Buckelew,
New York.

Dear Sir:

The Collan Oil I purchased last spring has been put to severe test on the golf links during the summer, owing to the unusually wet season. It has exceeded my expectations. Shoes treated with it seem to repel water to a greater extent than with any other dressing I have been able to obtain. I anticipate much comfort from its use on my trip into the woods this fall. I have had a great deal of experience with so called waterproof dressings, and for some years have made up for my own use different combinations, but have not had better results than Collan Oil gives.

Yours respectfully,

Frank S. Hyatt.

The students of the Northwestern School of Taxidermy, Omaha, Nebraska, are loud in their praise of what the school is doing for sportsmen. This school teaches taxidermy by mail, through a course of 15 lessons and supplementary personal instruction and criticisms. Every sportsman should be interested in saving his best specimens of both animals and birds, and with this school available there is no reason why every one can not have a knowledge of how to mount them properly and skilfully for himself. The school has just issued a new illustrated catalogue and is sending it free to all readers of RECREATION.

The Ideal Manufacturing Company, New Haven, Conn., has put out still another new bullet. This is made in response to a request from Gen. G. F. Elliott, U.S.M.C., under whose orders careful experiments were conducted for the purpose of determining the best load for short range rifle practice. The new bullet is numbered 308, 245, and anyone interested in learning about it can get a circular by addressing the company as above. A complete outfit for preparing and reloading the new ammunition has also been made by the Ideal Company, and is described in the circular referred to.

The Gas Engine and Power Co., Morris Heights, New York City, has issued another beautiful catalogue of naphtha launches, which, like its predecessors, will prove a surprise and a delight to every lover of art. The cover is a dream and the inside pictures are gems. The text is full of information, and no one can spend 10 minutes looking through this book without longing to get out on the water. You should have a copy, whether you live near the water or not. When you write these people don't forget to mention RECREATION.

Stony Island Club,
Henderson Harbor, N. Y.

D. M. Tuttle Co.,
Canastota, N. Y.

Dear Sirs:

The 20-foot boat from your factory ran 2,000 or 3,000 miles last season, making a trip to Henderson Harbor or Sacket's Harbor, or both, every day. She never stops for the weather. She never yet had to be towed or rowed in.

Yours truly,
Frank Horton.

Alexandria Bay, N. Y.
A. W. Bishop & Son, Racine, Wis.

Dear Sirs: I received the Independent Spooling Device and Reel in good condition and it is the finest reel I ever used for casting. I have fished here all my life and know what a good reel is. I will push your Even Spooling Device next season. Find enclosed my check to cover amount of bill.

Yours truly,
E. D. Paterson,

(Dealer in high grade fishing tackle.)

The Century Camera Co., of Rochester, N. Y., write me that their 1904 catalogue is now in course of preparation, that it will be published on or about March 15th, and that they will be pleased to send it to any one interested in photography. They state that this new catalogue will be the most attractive piece of printed matter they have ever published, and that it will give detailed

information concerning the various improvements which they will embody in the construction of their 1904 designs.

I am advised by Buzzacott that owing to an unfortunate occurrence it is impossible for him to complete the issue of his series of books until new plates shall be made and old ones restored. Buzzacott personally guarantees, however, to fill every order now *en route*, or money refunded, just as quickly as it is possible to complete the work of restoration, which is already begun for an entire new re-issue.

Buzzacott will commence re-issue at his exhibit at the Louisiana Purchase Exposition.

The Gundlach-Manhattan Optical Co., of Rochester, N. Y., suffered a serious loss from fire January 18th. All the cameras completed and in course of construction and a large quantity of other photographic stock were destroyed. This will entail some delay on the part of the company in filling orders for cameras; but fortunately the optical department of this great factory escaped damage, and orders for lenses, microscopes and field glasses can be promptly filled.

The Polk Miller Drug Co. is doing a land office business in the sale of Sergeant's dog remedies, which have been thoroughly tested by kennel owners, dog fanciers and veterinary surgeons all over the United States, who give them unqualified praise. All interested in the subject of dogs should own Polk Miller's valuable little book, "Dogs," which will be sent to any address from Polk Miller Drug Co., Richmond, Va., on receipt of 3 cents to cover postage.

The C. P. Goerz Optical Works, 52 Union Square, New York, have issued a beautiful catalogue of 100 pages, describing their lenses, field glasses, opera glasses, cameras and shutters. The book contains many beautiful reproductions of pictures made with Goerz lenses. Every man or woman interested in photography or nature study should have a copy of this catalogue. When you write for it, please say where you saw it mentioned.

At Hamilton, Ontario, January 14th, the Grand Canadian Handicap was finished. This match, which is the blue ribbon event of Canada, brought out 43 entries, each competitor shooting at 20 pigeons, from 27 to 32 yards rise. There was not a straight score made; 8 men only made 19 and all these men shot Parker guns. In the shoot-off, Mr. M. M. Mayhew was 1st and Harry Kirkover was 2d.

EDITOR'S CORNER.

WISCONSIN WARDENS BUSY.

The deputy game wardens of Wisconsin have been making more trouble for law-breakers in that State in the past few months than could be told of in 2 pages of RECREATION. I should like to enumerate all the arrests and convictions these officers report, but can not spare space for it. Here are a few:

L. Eld, Oscar Larson and C. Wickiton, of Bayfield county, evidently did not approve of the law which requires each resident of that State who wishes to hunt to take out a license at a cost of \$1. These 3 men, therefore, shouldered their guns and went into the woods without complying with this formality. Game Wardens John Buckley and H. Lund followed them, arrested them and took them into court, and the Judge fined each of the offenders \$50 and costs. Think of it! That sum would have provided these men with resident hunting licenses for 50 years to come; yet they had to put up that amount for hunting without a license one day. Some people have strange ideas of economy.

Another man who went hunting without a license is Julius Stinke, of Sauk county. He was also fined 50 and costs at the suggestion of Deputy Warden H. H. Hilbert. Stinke should add a final R to his name.

Charles Miller, of Brown county, undertook to evade the local license law and was arrested by Deputy Warden Wm. Haslam. He made a big fight in court, and was fined \$50 and costs, amounting to \$80. Mr. Miller should now sell his gun and devote the rest of his life to sawing wood.

Several men were arrested and fined for shooting ducks at night. It is all right enough for a man to work overtime at any legitimate occupation, but a decent man can always get fun enough with a gun between sunrise and sunset, and it is better to quit at sundown, even if you have not secured as many birds as you would like to have.

J. P. Jones and Henry Finn, of Milwaukee, went to South Dakota to shoot ducks. They brought home a lot of the birds in a telescope grip, but unfortunately left some of the wing feathers sticking out. Valentine Raeth was at the station when the men alighted from the train. He immediately made a point on the grip, took charge of it and of the men who carried it. The local Justice of the Peace charged the men big prices for bringing their game into Wisconsin without complying with the State law which requires all packages containing game to be tagged as such, and Jones and Finn did not get to eat their ducks after all. The game warden

sold them and applied the proceeds to the State Game Protective Fund.

Valentine Raeth, of Milwaukee, made 9 seizures in November and 11 in December of game that was being shipped out of that State in violation of law. Several offenders were caught and heavily fined. Some other cases are pending in the courts at this writing.

FAIR PAY FOR GOOD WORK.

For obvious reasons public servants can not be expected to increase their own salaries. No advance has been made in the pay of members of Congress and general officers of the government to keep pace with the heavy increase in cost of living and the universal increase in wages throughout the country. It costs approximately double to live in Washington as compared with the same standard at the home of members of Congress. The people are the employers and expect a high grade of ability in their public servants, but pay them less than such servants can generally earn in private life. Neither political party dare take the initiative to fix salaries on an equitable basis commensurate with the grade of service expected.

A petition signed by citizens without regard to politics will go to Congress recommending a revision. This is intended as an acknowledgment, by the people, of their appreciation of the value of the public servants and will furnish some reason for Congress to treat the subject and avoid criticism from either political party, particularly in view of the fact that no advance is to be made until after the next election, the result of which can not be foretold.

Readers favoring the movement can cut out, sign and mail this petition to "Sentry Box" 825 Vernon avenue, Washington, D. C., a non-partisan bureau not conducted for profit. The integrity of its act is guaranteed by its founder, a man of international repute in commerce and finance.—EDITOR.

We, the undersigned, respectfully petition the 58th Congress to fix the salaries of the following government officials at the amount indicated under the column headed "Proposed Salary" to take effect December 1st, 1904.

	PRESENT SALARY.	PROPOSED SALARY.
President	\$50,000	\$75,000
Vice President.....	8,000	15,000
Each Cabinet officer.....	8,000	10,000
Chief Justice.....	10,500	15,000
Associate Justices.....	10,000	12,000
United States Senators..	5,000	10,000
Members of House of Representatives	5,000	7,500

BATAVIA BRUTES HAVE SIDE HUNT.

Here are the names of a lot of Batavia, N. Y., swine, who, in October last, participated in a side hunt, together with the serial number of each man as recorded in the game hog book: Fred C. Kelsey, C. M. Vrooman, William S. Waldo, Homer Sweet, George E. Redshaw, Bert Coolidge, Edward Allen, H. M. Johnson, Jay L. Robson, Everest A. Judd, M. A. Nichols, L. A. Parmele, Fred Kelsey and M. E. Vrooman. The local paper states that skunks, foxes, and wild geese were each to count 100 points, but that none of these were brought in. Rabbits, owls, ruffed grouse, black and grey squirrels, woodcock, blue herons, crows, coons, ducks, hawks, hell-divers, loons and mink were all to count 50 each, and it appears that only half a dozen of these were killed. Mudhens, martens, plovers, pigeons, red squirrels, weasels, snipe, killdeer and kingfishers were rated at 25 points each; chipmunks, 20 each; blackbirds 15 each and sparrows 10 each. It is stated that nearly all the game killed consisted of chipmunks, kingfishers and killdeer. The winning side had a supper at the expense of the losing side. Think of a squad of 14 men scouring the country for miles around Batavia and bringing in at night enough chipmunks, kingfishers and killdeer, rating at 20 to 25 points each to aggregate 3,330 points. How proud these scavengers must have felt to see the hundreds of these little birds and rodents stacked up in the banquet room! It is a pity the entire herd of raiders did not string up their game and have it and themselves photographed in order that the world might know what they look like.

Their names are: F. C. Kelsey 981, C. M. Vrooman 982, Waldo 983, Sweet 984, Redshaw, 985, Coolidge 986, Allen 987, Johnson 988, Robson 989, Judd 990, Nichols 991, Parmele 992, Fred Kelsey 993, M. E. Vrooman 994.

THE BROWNLOW BILL.

A bill has been introduced in Congress by the Hon. Walter P. Brownlow, of Tennessee, and the Hon. Jacob H. Gallinger, a member of the Senate from New Hampshire, appropriating \$24,000,000 for the purpose of building wagon roads. This money is to be apportioned to the States according to population, except that no State shall receive less than \$250,000.

Each State receiving National aid from the Government must add a like amount to the sum received. This will result in the spending of \$48,000,000 for roads, will build 6,000 to 7,000 miles of excellent road, and will place in each State 100 to 500 miles of hard road, which will not be affected by frost or spring rains, and on which

the farmer can haul big loads the year round. It will be a great advantage to those living near it, but it will be a far greater advantage to the whole country because it will be a wonderful object lesson and will prove to everyone that a good, hard road which can be used all the year, no matter what the rains are, is a desirable thing. It will make everyone who sees this road and who uses it want more roads like it, and it will cause more roads like it to be built.

While under the Brownlow bill the building of 6,000 to 7,000 miles of good road is a great project, yet it seems to many that the greatest advantage of this bill is the wonderful object lesson which 100 to 500 miles of good road will produce, when built in every State of the Union.

Write your Congressmen and Senators and urge them to support this bill.

The would-be spring shooters are hustling for the privilege of again indulging in their favorite style of slaughter. Several bills have been introduced in the New York Legislature aiming at an extension of the open season so that wild fowl may be killed while on the way to their breeding grounds, but it is not likely that the decent sportsmen of this State will allow any of these bills to pass. New York has taken a long step forward, and should not now take even a short step backward. We are the 11th State to prohibit spring shooting. The others will come into line rapidly, and New York should not allow herself to get any farther back than she is now.

A winter resort hotel in Virginia advertises that a fair shot can bag 5 to 20 dozen sora on a single tide. I asked the manager for the names of some of the men who had done such shooting, and he referred me to Fred F. Palen, of Newport News, and to his own game keeper, whose name is A. Croonenberghs. Mr. Palen writes that he and 4 other men killed 526 sora on one tide, and Croonenberghs admits that he killed 157 on one tide. The latter's title should be changed to game destroyer instead of game keeper. His number in the game hog book is 995. Palen's number is 996.—EDITOR.

Mr. James B. Dill, 27 Pine street, New York, has been for years a subscriber to RECREATION. January 10th he sent me a check for \$8, to renew his own subscription and to pay the subscriptions of 7 friends, to each of whom he had made a present of a year's subscription to this magazine.

Mr. Dill is one of the most successful corporation lawyers in this country, and is probably the only one who has ever received

a fee of \$1,000,000 in a single case. This incident proves that some of the brainiest and busiest men in the world read RECREATION and appreciate it.

H. S. Tubbs, a deputy game warden of Manchester, Ia., went into Minnesota, killed some game and was caught in the act of shipping it out of the State. A local warden arrested him and took him to court, where the Justice assessed a fine of \$100 and costs on him. No doubt Tubbs is zealous in prosecuting the lawbreakers at home, and it is exceedingly gratifying to learn that when he undertook to violate the laws of a neighboring State, he should have been given a dose of his own medicine.

Game Wardens John F. Luman and D. F. Shea, of Massachusetts, called on Walter Dean and Mason Dean, of Oakham, that State, some weeks ago and caught them in the act of fishing in Crawford brook with a seine. The offenders were taken before Justice Healy, of Oakham, and fined \$25 each. Albert Hapgood had also been monkeying with a net and was fined \$5.

Their numbers in the fish hog register are: Walter Dean 997, Mason Dean 998, Albert Hapgood 999.

New Jersey is fortunate in having on its State Fish and Game Commission at least one man who is a thorough sportsman and a warm friend of the cause of game protection. Mr. Percy Johnson, of Bloomfield, has been a vigorous worker on this line many years, and all law breakers have cause to dislike him. Notwithstanding this, Mr. Johnson goes on the even tenor of his way and is still bringing men to justice for infractions of the game and fish laws.

A dispatch from Ann Arbor, Mich., states that after a wind and rain storm which occurred there some time ago, the janitor of the court house picked up 3 bushels of dead sparrows on the court house grounds. It was found by careful count that there were 1,500 dead sparrows in the bunch. Truly, it is an ill wind that blows nobody good, and the citizens of Ann Arbor may congratulate themselves that the Storm King rid them of so many of these pests.

The express company doing business at Rifle, Colo., makes the following report of deer shipped from there during the past 3 years:

1902, 650.

1902, 428.

1903, 37.

This is only another page in the history of the passing of the mule deer.

At the request of the President of the Argentine Republic, an employe of the U. S. Bureau of Fisheries, has gone to Argentina to make investigations regarding the possibilities of fish culture in that country. He will be there 6 months. This is an important mission and it is gratifying that the Argentine government is showing so keen an interest in this subject.

Will Cave, of Missoula, Montana, who says he is county assessor, though the county letter head on which he writes does not bear his name, admits having caught 110 trout in 2 days, and adds, "I assure you that if I could have caught 200 trout in 2 days I would have done so."

He is registered in the fish hog book as number 1,000.

Joseph Parry and Arthur and Louis Loucie were arrested at Pawtucket, R. I., by Game Warden E. J. Burlingame for killing birds in violation of law and of hunting rabbits with a ferret. Each of the 3 vandals was fined \$85 and costs. They know more about game laws now than some men do who never violated one.

A man in Williamsport, Penn., has written me an interesting letter on the subject of game protection, which I should be glad to print if possible, but unfortunately the writer does not sign his real name, and so, under the rules of this office, his communication cannot be given any further attention.

Dr. Hugh M. Smith, deputy commissioner of Fish and Fisheries, U. S. Bureau of Fisheries, has returned to Washington after an absence of several months in Japan, where he went to study the methods employed by the Japanese in preparing fishery products.

A Western sportsmen's magazine comes to me with a half page ad of an automatic shot gun, and without a word of editorial condemnation of that infernal machine. There is a difference between some publishers.

Readers of RECREATION are cautioned against sending money to Dr. Morris Gibbs, of Kalamazoo, Mich. I have reason to believe that he is thoroughly dishonest.

Will Mr. C. H. Barksdull, who sent me a story entitled "A Day's Sport in Alaska," please give me his address.

Little Girl—Do you stutter all the time?
Little Boy—N-n-n-n-no; only when I talk.—Mail and Express.

We Double the Cost of Our Brewing to Give You Pure Beer

We spend fortunes on cleanliness.

For instance, we wash every bottle four times, when one washing—done, as it is, by machinery—seems more than sufficient.

We clean every tub, every boiling vat, tank or barrel, every pipe and pump, every time we use it.

We bore wells down 1400 feet to rock for pure water.

We cool the beer in filtered air.

We filter the beer by machinery.

We store Schlitz beer for months in refrigerating rooms until it is well fermented—until it cannot cause biliousness.

We sterilize every bottle after it is sealed.

All this doubles our necessary cost—an enormous item on our output—over one million barrels annually. Yet we pay it all—just to have Schlitz beer pure—just to have it healthful for you. Those who enjoy it pay none of this extra cost, for the price is the same as standard beers anywhere.

Ask for the Brewery Bottling.



A DEER, A WOLF AND A COUGAR.

Joseph Schlee, of this city, is one of those old timers who came to Oregon when it was a wilderness and the Indian held full sway. He was a noted hunter and trapper, but of late years he has been living quietly.

Recently Mr. Schlee was visiting a son-in-law on Mosby creek, a tributary of Row river. One day, while fishing, he was surprised to hear the bleat of a deer. In a few minutes he saw a large buck stagger into the water, almost immediately followed to the water's edge by a large gray wolf. Mr. Schlee held his peace and watched for developments. Evidently the wolf had been chasing the deer and the latter, hard pressed, had taken to the water. He had no time to seek deep water, but plunged in the nearest place, which proved only about 18 inches deep. The channel was narrow and whenever the deer made an attempt to pass down stream the wolf showed almost human intelligence in thwarting his prey and confining him to shallow water, waiting an opportunity that would mean the downfall of the buck. Several times the wolf plunged in and worried the poor animal. Finally the wolf made a desperate effort, and succeeded in catching the buck on the top of the neck and forcing his head into the water, drowning him in a few minutes.

The victor was dragging the buck to shore when Mr. Schlee decided to take a hand in the matter and drove the wolf away by stoning him. The buck was a fine 4 pronged specimen. Mr. Schlee secured assistance and removed the carcass.

An after thought impelled him to take his rifle and return to the spot, where he thought it possible the wolf would return. All was quiet, and he was in the act of returning to the cabin, when he heard the scream of a cougar. By that time the old gentleman's hunting blood was up and he was out for game if any came along. The sound was near, and before long he saw a mountain lion crossing the creek a short distance up stream. He took a hasty shot, but missed, and the cougar made into the bushes. Mr. Schlee started his dog up the creek. They had no trouble in striking the trail and only a few minutes were necessary for them to tree the animal. At that point the timber was large and dense, but no time was lost in coming to the tree in which the dog had located the cougar. Mr. Schlee carelessly approached the tree thinking the animal had climbed to probably the highest point to be reached. He came near the trunk of the tree, trying to locate the animal. Not seeing him he was in the act of changing his position when he saw, within 10 feet of him, the cougar crouched on one of the lower limbs. Schlee leveled the rifle and pulled the trigger. The shot went home and the cougar fell dead at the root of the tree.

J. S., College Grove, Ore.

A doctor's wealth: ill-gotten gains.—Exchange.

IN YEARS GONE BY.

Thirty-five years ago the woods of Alleghany county, N. Y., were full of game, consisting of foxes, rabbits, squirrels, ruffed grouse, wild pigeons and coons. The streams were teeming with trout, and it was a paradise for the boy who loved gun and rod.

Well I remember one bright morning in late October; a light snow had fallen the night before and several of us boys, accompanied by Andrew, an old hunter and trapper, started out for a coon hunt. After ascending a hill a mile and a half from a small village, we struck into an old chestnut grove, and found by the numerous tracks in the light snow, that coons had been abroad the night before.

Old Andrew made a careful inspection of the tracks, and soon located the coons in a chestnut stub. He cut ironwood poles about 6 feet long, and $\frac{3}{4}$ of an inch in diameter at the butt for each of the boys, and said they were to be the only weapons used in despatching the game. He told us that if we could hit a coon on the nose just below the eyes a slight blow would kill it, but if hit elsewhere their fur would protect them. We stripped off our coats and made the chips fly cutting down that old stub.

When the stub began to lean and crack we dropped our axes and grabbed the poles. As the stub struck the ground it broke at the bottom of the hollow, and 6 coons made lively work trying to reach other trees. It was the first time most of the boys had hunted in this manner, and they whacked one another nearly as often as they did the coons, but we succeeded in killing 3 coons before they reached other trees. Two ascended a large red oak, 3 feet in diameter; the other climbed a small basswood stub. We soon felled the tree and secured the coon. We dared not cut the other tree without permission from its owner, so one of the boys went to him and got his consent. We went at that tree as only boys after a coon can work, but by the time we had it down we were a tired and hungry lot. When it fell, we soon despatched the 2 coons, and then forgot out hunger, blistered hands, and fatigue. With 6 coons we returned to the little village, proud and happy.

Yesterday I passed the spot where I spent that happy morning 35 years ago. Not a tree crowns the mountain top, the spring is dry, the soil barren and worthless and a deserted house where the grove ended in a meadow, shows that man can not survive the ruin he himself has wrought. Not even the lone phoebe can brook to build her nest and rear her young amid this desolation. The chestnut grove has disappeared, and with it all that made the mountain top so beautiful.

W. J. W., Wellsville, N. Y.

Cannot possibly get along without RECREATION. John R. Taylor, Freeport, Pa.

THE EQUITABLE

J.W.ALEXANDER
PRESIDENT

HENRY B. HYDE
FOUNDER

J.H.HYDE
VICE PRESIDENT



MARCH WEATHER

is uncertain—so is your future. You can't control the weather, but you can control your own future.

An adequate Endowment policy in the Equitable will take away all uncertainty from your future—and from that of your family.



Opportunities for men of character to act as representatives.

Apply to GAGE E. TARBELL, 2ND Vice President.

For full information fill out this coupon, or write

THE EQUITABLE LIFE ASSURANCE SOCIETY OF THE UNITED STATES

120 Broadway, New York

Dept. No. 16

Please send me information regarding an Endowment for \$.....if issued at.....years of age.

Name..... Address.....

AMATEUR PHOTOGRAPHY.

"For sport the lens is better than the gun."

I wish to make this department of the utmost use to amateurs. I shall, therefore, be glad to answer any questions and to print any items sent me by practical amateurs relating to their experience in photography.

CLOUD PHOTOGRAPHY.

Judging from the number of bald headed sky pictures in most collections of landscape photographs, a few practical suggestions may not come amiss. I will confine myself to the subject of photographing the clouds on the same plate with the foreground at one exposure, and will not touch on the printing in methods.

The chief difficulty lies in the fact that by the time the foreground has had ample exposure the sky and clouds are much over-timed and all detail in the sky is lost. Together with this there is always some halation. Many clouds are so thin that the blue light of the sky shines through them and acts on the plate almost as strongly as the light from the unclouded portions of the sky, rendering the clouds faint in the negative.

To overcome the halation we can use the non-halation or double coated plates, or we can back our plates. Those who use films are not troubled with halation. Fairly good cloud pictures can be made on the ordinary plate by giving a short exposure, 1-6 to 1-10 of the normal time, for the average landscape, and then developing slowly in a much diluted developer; starting with about $\frac{1}{4}$ normal strength and as the detail comes up adding more strong developer for density, being careful not to overdevelop. A color screen may be used with the ordinary plate, but as the plate is only slightly sensitive to yellow light the exposure must be much increased; from 60 to 75 times for the Bausch & Lomb bichromate ray filter, for instance.

For the best results we must use orthochromatic, or color sensitive, plates, with or without a color screen. Some of the color sensitive plates on the market do not require a color screen. When using a color screen with an orthochromatic plate the exposure must be increased according to the screen used. With the Bausch & Lomb ray filter multiply the exposure by 3 to 5. When making negatives chiefly for cloud effects and in which the foreground is of little or no importance, using the color sensitive plate with or without the color screen, cut down the exposure as with the ordinary plate, though probably not so much. When detail is wanted in the foreground give sufficient exposure to get the foreground, and if the screen is suited to the

plate the clouds can be taken care of in development.

The secret of developing cloud negatives successfully is to develop slowly in weak solutions and not over develop. With short development in a solution of not over $\frac{1}{2}$ normal strength, when the sky portion becomes a little more dense than the foreground the white clouds will have full density and the foreground should be sufficiently developed. That is the time to stop. However, if the foreground is still weak when the sky is dense enough, stop development anyway; as the resulting negative will be better than if development were carried on until the foreground had gained sufficient density.

A weak foreground may often be coaxed up by local development. If the sky appears to be gathering density much more quickly than the foreground, remove the negative from the developer before the sky is fully developed and rinse in water. Then soak a piece of cotton in full strength developer, sponge out the excess so that it will not drip and carefully go over the foreground. It will gradually gather strength. Keep this up until the foreground is more dense than the sky. Then put the negative back in the original solution and continue development until the sky is sufficiently strong. Remove from the developer, rinse and fix.

R. L. Wadhams, M. D., Wilkes-Barre, Pa.

IMPROVING NEGATIVES.

II.

I believe velox to have been the first gaslight printing to appear in the American market, and it is probably the best known. The amateur is apt to make all his prints on one grade of paper, never stopping to consider whether he might not obtain a better result from a certain negative by a change of printing medium. We have all read, and I trust practiced, the time-worn advice to choose one plate, developer, etc., and stick to it until its manipulation is mastered. This is good advice, but there is such a thing as following a rule too closely.

To judge what paper will be best to use, sort the negatives and make 3 classes. Put in one pile all those that are extremely dense and contrary; all those that are approximately correct in exposure and development in a second pile; while the thin, flat printing ones will form the third group. In this last lot place also those negatives that are over exposed, but dense, over developed; for these, though slow printers, will give poor, flat prints, like the others in this class.

Having made these 3 groups, the question arises whether to use a grade of paper which will bring out the best there is in

the negative, or to modify the faulty negative to suit a certain grade of paper. Either course is open to the worker, but for the present we will consider the first suggestion.

The slower a plate the more quickly it will develop and the more contrast it will give. This also holds true with gaslight paper, as does the opposite statement that a quick plate or paper will develop slowly and give less contrast, relatively speaking. For dense, contrasting negatives a quick paper is indicated.

For the second lot of negatives, those that are probably fair as printers, special velox will give good results. In fact, it can be used for 80 per cent of all negatives. For some landscapes and portrait work try rough velox. It will produce prints which are the equal of platinotypes in appearance. It is better to choose the faster grade when a choice of speeds is offered, as most of the papers now in use tend toward contrasty results.

Having considered the dense and the medium classes of negatives, there remains the third and, to my mind, most unsatisfactory class, comprising those that are too thin to give good prints. These negatives need a paper that will give the maximum contrast, and for that purpose carbon velox is best. There is trouble at first in handling it quickly enough and over development often results. To avoid that, arrange trays in a row, remove the print from the tray as soon as it is thoroughly wet with developer, dip it in the rinsing tray and put it in the hypo before it has time to develop too far.

Besides carbon velox try cyco. It is good paper and is adapted to thin negatives. In fact it is possible to select a paper that will give a good print from almost any negative, but do not get into the habit of slighting the exposure and development with the idea that it can all be made right in the printing. Nothing can equal a print from a correctly exposed and developed negative.

C. M. Whitney, Bayonne, N. J.

USE OF FERROTYPE PLATES.

Arthur Roth asks for a recipe for paste and a method of applying it to prints while on a ferrotype plate. It is obvious that his object is to find some method of pasting ferrotyped prints to mounts without destroying the high gloss. I advise him to try the following method: Apply to edge of print mucilage, not too thick, making a border about $\frac{1}{8}$ inch wide; place print on mount, lay thin sheet of white paper over it and carefully rub down; remove paper and run finger tip around edge of print. Next paste a piece of paper of the size and thickness of print to back of mount

to prevent cockling. If mucilage is evenly applied to print and allowed to dry about $\frac{1}{2}$ minute, none will exude to smear print when rubbing down on mount.

Care should be exercised in selecting plates when purchasing. Some time ago in selecting ferrotypes it was necessary for me to reject over 2 dozen in order to find 5 perfect plates. Nearly all presented a porous surface when viewed on the side in a good light. These pores, although small, no doubt account for the difficulty many experience in removing dried prints from ferrotype plates. If your plate has a perfect finish and you keep it so, it will not be necessary to use paraffine. Manufacturers of ferrotype plates should turn out better goods, and if necessary charge more for them. H. A. Kalkman, Newport, R. I.

SNAP SHOTS.

Almost every amateur knows that his printing out paper will not keep fresh a great length of time, neither will his chemicals after mixing, but it is not known just how long a dry plate can be kept without depreciating to such an extent that it will fail to produce a good negative if care is taken in development.

Two years ago I was on a hunting, fishing and camera shooting trip on the St. Francis river, Cross county, Arkansas, and ran across 4 boxes of dry plates that had been left by an itinerant photographer, who had departed between suns, owing a board bill, 5 years before. Having used all the plates I had taken with me I decided to give the find plates a trial. In Memphis, September 29th, about 4 o'clock in the afternoon of a cloudy day, I gave the plates an exposure of $\frac{1}{4}$ of a second, using a ray filter for cloud effects. Subsequent development and printing gave me pictures that surprised me, for I did not expect much. Considering the time of year and day, briefness of exposure and ray filter it was a fair showing for plates 7 or 8 years old.

Jas. G. Wheat, Louisville, Ky.

On page 82 of the January, 1904, issue of RECREATION I see that Edward Krivanek, Chicago, Ill., asks how to prevent prints sticking to the ferrotype plate. I suggest that he thoroughly clean the surface of his plate, using ammonia or washing soda in the water. Before using the plate dust on a little powdered talc or French chalk, removing any excess. Then wax the surface of the plate with the following solution:

Yellow resin....90 grains.
Beeswax15 grains.
Turpentine4 ounces.

To apply the wax coating, put a little of

the solution on a piece of flannel and rub the wax lightly over the surface of the plate. Allow it to stand a few minutes and then polish with a clean, dry piece of flannel. This waxing must be repeated before each time the plate is used.

R. L. Wadhams, M.D., Wilkes-Barre, Pa.

I notice M. B. More's letter in regard to pyro staining his films. I am a constant user of, and a firm adherent to pyro, but have always used plates. Recently, however, I was called on to develop a few rolls of 4x5 films for a friend and found they were all stained, some badly, and some only to a slight extent. Some I had to correct in development, but others that required no correction were as badly stained as any.

Will some one who uses hypo on films please explain for Mr. More and me why the films stained?

I should add, perhaps, that with one exception, this has been my only experience with films. Once before I developed one roll, and on them there was no evidence of stain. The developer used on them had been prepared a month or more, while that used the last time was freshly prepared.

Harry E. Momyer, Klamath Agency, Ore.

Occasionally one scratches or tears the film of a negative during the process of developing or fixing. It does not always happen that one is equipped with necessary material for filling the hole thus made; and even if so, it is a delicate operation, requiring practice and skill. I recently had a case of this kind and in looking about for some convenient method of doctoring the negative, I could think of nothing better than a box of ordinary shoe blacking. I got a small brush, such as is used for oil paints, dipped it in water, rubbed it over the blacking and applied it to the back of the negative over the defect, working it out to about the same density as the negative and being careful to blend the edges. One good feature of this plan is that it does not involve a risk of spoiling an otherwise good negative.

O. T. Kirtley, Hannibal, Mo.

I do not like fuzzy pictures. I have become disgusted with the so-called art pictures that appear from time to time in photo publications. I think I voice the sentiment of the majority of your subscribers when I say that I want to look at good photographs such as RECREATION usually publishes; clear, plain, comprehensive and full of detail. I do not admire such blotches as appear on page 345 of November RECREATION. They may be art, but I venture the assertion that your readers, as a lot, will not rave over them. Bet-

ter cut that kind and let us have more good hunting and fishing yarns.

J. E. Bates, Spokane, Wash.

On page 32 of the January issue of RECREATION there is a good picture of a fantail pigeon which to me is rendered unattractive by the 2 large inscriptions. One cuts off part of the bird's right foot, the other crosses one corner of the tail. If photographers must have their names and other reading matter on prints, let them put the inscriptions where they will be least objectionable. In this picture there is plenty of room at the bottom without interfering with the subject. A number of pictures I have seen lately have had this disagreeable feature.

R. L. Wadhams, M.D., Wilkes-Barre, Pa.

What can I use to make inscriptions on negatives so the letters will print white or nearly so?

E. Bartholomew, Ravenna, Mich.

ANSWER.

Use India ink. Higgins' liquid India ink is convenient. A good opaque, such as Gibson's, will answer the same purpose. To print sharply, the lettering must be made on the film side; then it is necessary to write backward. Or the lettering may be done on transparent tissue and placed between the negative and the paper.—EDITOR.

Please give a formula for sensitizing linen. Also directions for printing and developing pictures on that material. Can celluloid be sensitized? If so, how?

S. Busch, New York City.

Will some reader please explain?—EDITOR.

If the readers of RECREATION will write me I will send them formulae for developing paper and for toning gelatine paper which will not fade. E. E. Strock,
529 State street, Conneaut, O.

"Well, Snowball," said the patron to the dusky waiter, "how did you ever come by a name like that?"

"Well, sah, I was born in Chicago. Reckon you never seed a Chicago snowball, sah!"—Yonkers Statesman.

RECREATION is the best hunting and fishing periodical in the market.

Howard D. Taylor, Buckley, Wash.

RECREATION is the best publication of its kind I ever read.

Wm. Bates, West Plains, Mo.

EASTMAN N C FILM

*Lies Flat,
Dries Flat.*

No bothersome curling in development—no rolling up of the negatives afterward.

It has other advantages too—orthochromatism (i. e., a correct rendering of color values) speed—latitude.

Your Kodak dealer has it. No advance over the prices you have always paid for Eastman film.

**\$4,850.00 in Cash Prizes for
Kodak Pictures. Send for Circular.**

**EASTMAN KODAK CO.
ROCHESTER, N. Y.**

The Century Catalogue for 1904

is now in press, and will be issued at an early date. Century Cameras this year will be just as far in the lead as ever. If you want to know all about the finest line of Cameras in the market, get a copy of the Century Catalogue from your dealer, or we will mail it direct, upon request.

**CENTURY CAMERA COMPANY,
ROCHESTER, NEW YORK.**

Do you want a Good, Reliable,
Substantial, Well Made

Single Barrel Shot Gun

If so, send me

10 YEARLY SUBSCRIPTIONS

and I will send you such a
Gun as a premium

It is made by the *DAVENPORT ARMS CO.*, and this means it is made of good material and that only good workmanship is put on it.

This is one of the many remarkable opportunities *RECREATION* is offering to men and boys to fit themselves out completely for shooting and fishing.

Sample Copies for Use in Canvassing
Furnished on Application.

Address

RECREATION

23 W. 24th St.,

New York City

Free: If you send your subscription to *RECREATION* through me or direct to the office to be placed to my credit, I will send you, free of charge, any one of the articles mentioned below:

Shot gun bench crimper, sells for 75 cents, in 10-12 16-20 gauge.

Shot gun cleaning rod, three attachments, sells for 50 cents, in 10-12 16 gauge.

Micrometer powder and shot measure, adjustable, and for both black and smokeless powder, sells for 65 cents.

U. S. Government rifle cleaner, any caliber, with attachments, sells for 60 cents, packed in neat canvas bag.

A duck, snipe or turkey call, sells for 75 cents each, best made.

A hand painted sporting picture, suitable for framing, and just the thing for your den, worth \$1.50.

"Hunting in the Great West," by G. O. Shields. H. S. Hill, 815 11th Street, N. E., Washington, D. C.

Please accept my thanks for the pair of wick plugs made by Hemm & Woodward that you sent me for 3 subscriptions. The plugs are perfect.

Wm. A. Nyce, Jr., Poughkeepsie, N. Y.

RECREATION has taken all the game hog out of me. I try to induce others to read your excellent magazine.

R. E. Bassett, Bassett, N. J.

PREMOS and POCOS

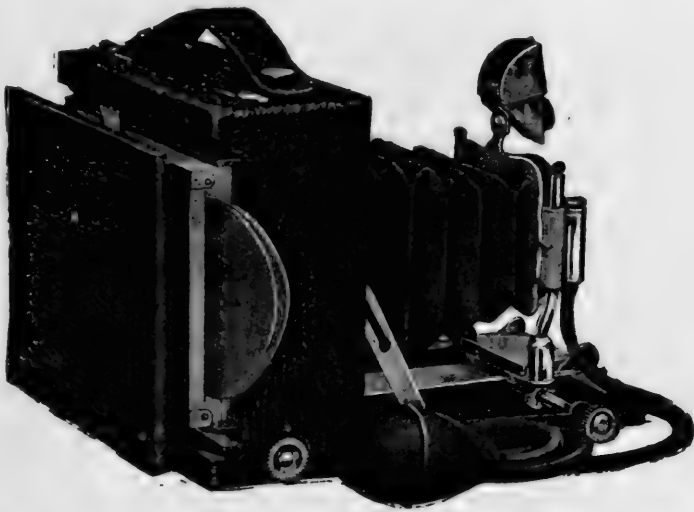

*as
Film
Cameras*

By means of Premo Film Pack Adapter any $3\frac{1}{4} \times 4\frac{1}{4}$ or 4×5 Premo or POCO becomes a daylight loading film camera, and you may

**Focus on the
Ground Glass
Just as with Glass Plates**

The Film Pack (12 exposures) loads into Adapter in simplest possible way. After exposure, a single motion presents next film.



ADAPTER—size of ordinary plate holder

$3\frac{1}{4} \times 4\frac{1}{4}$ Premo Film Pack Adapter	• • • • •	\$1.00
Premo Film Pack, 12 exposures, $3\frac{1}{4} \times 4\frac{1}{4}$	- - - - -	.70
4×5 Premo Film Pack Adapter	• • • • •	1.50
Premo Film Pack, 12 exposures, 4×5	- - - - -	.90

For use with Film Pack only

PREMO FOLDING FILM CAMERA

PREMO BOX FILM CAMERA

Rochester Optical Co., ROCHESTER
NEW YORK

Ask the dealer or write us for booklet



“99% of Camera value is in the lens”

The “Style B” Goerz lens lets light through with the least possible resistance—this is necessary for instantaneous photography. Our new formula for the Goerz “Style B” has produced a lens which enables the amateur to make pictures under conditions which have heretofore been considered unfavorable. When you buy a camera tell the man you want a Goerz lens.

Sample Photographs sent on request

C. P. GOERZ, Room 27, 52 E. Union Square
NEW YORK CITY

OIL PORTRAITS ON APPROVAL.

If you will send me a photo of yourself or a friend and state color of hair, eyes and complexion I will paint and send you on approval a miniature oil or pastel portrait.

Canvas 6x8 or 8x10 inches, \$10.00
Canvas 10x12 or 12x14 inches, \$15.00

Z. EMMONS, 58 West 104th St., New York.
Reference: Mr. G. O. Shields.

LANTERN SLIDES COLORED SKILLFULLY AND ARTISTICALLY

FOR
Lecturers, Teachers and others

I refer by permission to the Editor of RECREATION

MRS. C. B. SMITH
The Ansonia, 74th St., & Broadway,
New York City.

I received the Horton steel rod you sent me for subscriptions to RECREATION. I am much pleased with it and do not see how you can afford to give such premiums.
Chas. Metz, Sheridan, Wyo.

For Golf & Tennis Players

GLASSES WITHOUT TEMPLES

“PRESTO! – CHANGE!”

ATTACHABLE EYEGLASS TEMPLES

GLASSES WITH TEMPLES

Eye Glasses into Spectacles. Spectacles into Eye Glasses

BE PROTECTED!

DON'T BREAK OR LOSE YOUR GLASSES IN EXERCISE, WIND AND STORM

Can be attached by anyone *Send thickness of lens when ordering by mail*

Price in Nickel 50c. a pair. Gilt 75c. a pair. Gold Filled \$1 a pair. Solid Gold \$2.50 a pair.
Established 1842 GALL & LEMBKE, Dept. C, 1 W. 42d St. 21 Union Sq., New York Send for Circular

No. 3 Weno Hawk-Eye

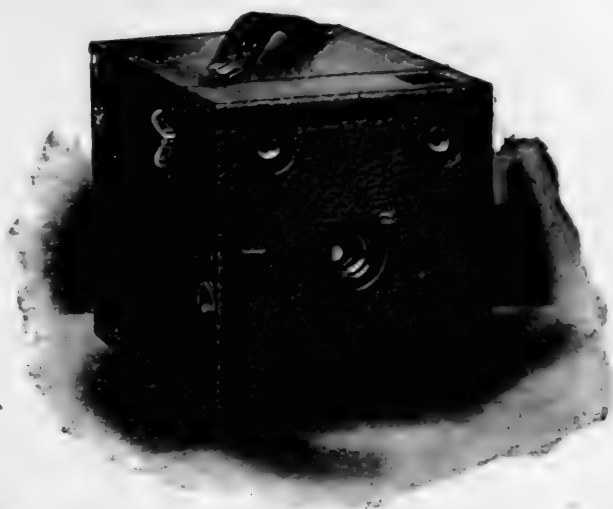

POPULAR SIZE

POPULAR PRICE

EASY TO OPERATE

EVER READY

Makes picture $3\frac{1}{4} \times 4\frac{1}{4}$. Sells for \$9.00. Fitted with Automatic Shutter, Iris Diaphragm, Universal Focus Lens. **It's EVER READY.** Uses Perforated Daylight Loading Film, also Eastman Cartridge Film.

No. 3 Weno Hawk-Eye, \$9.00

Full Description in Hawk-Eye Booklet.

BLAIR CAMERA CO.

Rochester, N. Y.

The Guthrie hunting shoes, which you gave me as a premium for RECREATION subscriptions, arrived O. K. I was surprised to receive such fine articles. Both material and workmanship seem thoroughly first class, and the fit is perfect. I thank you most sincerely.

G. A. Stengle, Palo Alto, Cal.

When I began buying RECREATION I found something that suits me. I had been reading Forest and Stream and the American Field, but RECREATION excels them all.

Wm. Hazen, Tippecanoe, Pa.

The hammerless revolver made by Harrington & Richardson duly arrived and is a beauty. Kindly accept my hearty thanks for same.

N. A. Meyer, Granby, Que., Can.

I have become so attached to RECREATION that I can't miss a number.

Chas. Carlson, Oil City, Pa.

Burnt Work — Something Great. To persons sending subscriptions to RECREATION through me, or sending them direct to the office to my credit, I will send the following prizes:

For 1 yearly subscription to RECREATION I will give a neat barrel match safe mounted on an oval back, both burned and decorated, equal in value to 75 cents.

For 2 yearly subscriptions to RECREATION I will give a 6-inch round picture frame burned and decorated with beautiful old fashioned poppies tinted with water colors. This would cost you \$1.25 at the least.

For 5 yearly subscriptions to RECREATION I will give either a round stool 14 inches high with round upholstered top or a square stool same height with square upholstered top. These would probably cost you \$7 or \$8 finished as I finish them with designs burned in the wood and leather.

E. A. King, Pleasant Prairie, Wis.

**We conduct monthly
contests with over**

**\$20.00
IN PRIZES**

Amateur Photographers!

Hundreds of subscribers tell us we are publishing the best magazine for amateurs. You **must** see a recent number—send 2-cent stamp. Current issue, with 1004 Prize Announcements for 10c. stamps or coin. Send at once and get our new Clubbing Offers and big Premium List under which you get

A YEAR'S SUBSCRIPTION FREE

**Western Camera Notes, 526 Hennepin Ave.
Minneapolis, Minn.**

HUNTING IN THE SIERRA MADRE MOUNTAINS.

ERNEST E. RUSSELL.

The completion, in 1897, of the first division of the Rio Grande, Sierra Madre & Pacific railroad from El Paso, Texas, 150 miles Southwest to Casas Grandes, Mexico, opened a new field for American sportsmen. Blacktail deer can be found within 10 or 15 miles of the railroad along the greater part of its line. From spring to autumn one can hardly make a trip over the road without seeing one or more herds of antelope. Thirty to 75 miles West and Southwest of Casas Grandes whitetail deer and turkeys abound, with occasionally a silvertip, cinnamon, or black bear, a mountain lion, and a few wolves. Ducks are plentiful along the larger streams; chiefly teals, but some mallards.

The climate is superb. The best time for hunting is from the middle of October to the first of January. In the latter part of that season the nights are cold, and a snowstorm may be encountered; but usually the days are sunny and so warm that a coat is burdensome. The mountains are covered with grass and a sparse growth of pine and live oak. Numerous brooks afford the best of drinking water.

I hunted deer 75 miles Southwest of Casas Grandes in December, '97, and January, '98; each time in company with A. M. Tenney, Jr., of Colonia Diaz, and George Lunt, of Colonia Pacheco, Chihuahua. I killed 2 deer on my first trip, which was also my first deer hunt.

Tenney is by long odds the most successful deer hunter in that region, and Lunt is generally rated as second to Tenney. In the past, deer have been so plentiful and hunters from outside so few that the residents have killed deer in large numbers, not only for their own use but for the market. However, the time has come, as is generally admitted down there, for checking this wholesale slaughter. It is expected that before another hunting season opens the Mexican Government will put in force an adequate game law. I have heard Tenney express himself in favor of it. It does not seem fair to condemn these people for killing deer in such large numbers in the past, however much the sportsman is justified in condemning like action in the Adirondacks or in Maine, where the extermination of game is imminent; so I venture to give some figures to show what one man can do in the Sierra Madre mountains.

Tenney is 29 years old. He was born in Utah, but spent most of his life in Apache county, Arizona, and the adjoining county in New Mexico. He moved to Mexico 6 or 7 years ago. His life on the frontier brought him into the company of the best hunters of that region of big game and plenty of it. He says he has been a hunter since he was 13 years old.

His highest record for one day's deer hunting was made in December, '95, when

he killed 13 deer. The next day he killed 5 more. The meat was dried for home use. On a more recent occasion he went out on a 6 days' hunt with 3 other men. The party killed 57 deer, of which Tenney dropped 37. He killed 4 on the way to the hunting grounds and 33 in the 5 days devoted to hunting. Even if a hog about killing deer, he can not be called a hog about keeping them for on this occasion he offered to share alike with the rest of the party, and they gratefully accepted the offer. These figures show how his work in the woods compares with that of other men thereabout. When Tenney and Lunt are out together, Lunt gets about half as many as Tenney. It must not be inferred, however, that Tenney devotes himself entirely to hunting. He is a farmer and like most of the people in that region does a good deal of freighting.

Ducks and turkeys fare as badly when he gets after them. On one occasion he and a companion went duck shooting on the Palatada marsh, West of Colonia Diaz. They wanted mallards, but the teals kept swarming down in their way. At last they got disgusted and turned loose on the teals as well. In an hour they brought down 15 teals and mallards with about 30 shots.

With the hollow bone of a turkey wing or a piece of reed Tenney imitates the turkey's call with great success; so well, indeed, that he once inveigled an uncle of his into crawling half a mile through the grass to get a shot at "that turkey." On another occasion Tenney had chopped down a big pine tree, and while resting pulled out his turkey bone and gave the call. A gobbler answered. Again Tenney called, and again the gobbler gobbled. Tenney kept calling and the gobbler kept coming and gobbling, his tail spread and his wings scraping the ground. When he got to the tree Tenney had cut down he hopped up among the branches and picked his way along the trunk to within 6 feet of the stump. Then Tenney rose from where he had been crouching behind the stump. The gobbler gave a squawk of disgust and left. Why didn't Tenney shoot him? Because he had no gun.

Tenney has used many guns, and thinks any one of the standard small caliber smokeless powder guns will do good work in the hands of a man who knows how to use it. He killed the 37 deer with a Savage .303 caliber. Then he sold it to Lunt and bought a 25-35. He fitted it with Lyman peep, bead, and leaf sights, and thinks it is all right for deer.

Mr. Millyuns—Now, Tommy, you must go to school and work hard. Why, look at me! I started without a cent, and now I'm a millionaire.

Tommy—Yes, I know; but you can't do it any more. They all have cash registers now.—Mail and Express.



Don't trifle
with the **Safety**
valve

COFFEE accelerates, and over-works, the Heart! This is how it stimulates, and why such stimulation is dangerous.

Over-work weakens, and "runs down," a Heart, just as it would a horse.

A Heart that is "run down" continually cries out for more Coffee and generally gets it,—till the abnormal condition results in Heart-failure, or Nervous-prostration.

Nature sets the pace at which the Heart should beat, just as the Government Inspector sets the safety-valve on a steam Boiler,—at the highest pressure which it can safely carry.

Tampering with the "safety-valve" is risky. "Coffee-heart" is the penalty for forcing, (with Coffee,) more work from Heart and Nerves than food supports them in doing.

And,—Coffee-heart now debars many people from getting Life Insurance,—an ominous fact worth pondering over.

Postum cures "Coffee-heart" and re-builds Nerve tissue, while having the rich flavor, of fine old Government Java.

Because,—Postum is made from the outer coats of Wheat, in which are located the Phosphate of Potash that feed Brain and Nerve up to normal condition, so that they feel as good all day, as Coffee makes them feel for a few minutes in the day.

These outer coats do not give up their rich contents of Phosphate, except by thorough boiling,—as in Postum.

"Coffee-heart," Dyspepsia, and Nervousness, generally disappear when "Postum" has displaced Coffee six weeks.

A ten day trial will show marked improvement.

FOOD

Postum

COFFEE

THE MARKET HUNTER'S STORY.

KLATTAWAU.

"Well," said the old market hunter who had run across our campfire and invited himself to dinner, and who now felt called on to pay his shot with a story. "It must have been well toward January, 3 years ago, when one day I picked up a little 22 caliber center fire, single shot rifle that was a fast favorite of mine, and went up the river, where I often picked up a few grouse and rabbits. These brought 6 bits each, and I sometimes made big wages. This day, about 2 o'clock, as I was wallowing through soft snow knee deep, half carrying, half dragging a bag of small game, I came on the fresh trail of what I concluded was an elk. He was going up hill toward the Southwest, and if he continued in that direction would come out at an open point overlooking Missoula and the Bitter Root valley. That being the case, he would probably return along the ridge going back into the timber.

"I thought of going for a heavier gun, but gave up the idea, deciding to go straight up the hill, and if I found the trail there, to follow it carefully and take my chance of getting a favorable shot. I was not much in doubt as to what the result would be in that event.

"I found the trail, but it was well down on the Southern slope, near the edge of the timber. The track led down through a little cove, and there the elk had loitered a while. Then he came out and went quartering down toward a copse through which an old logging load lay. There I expected to put him up.

"The track led direct to the wood. With my feet wrapped to smother the snapping of twigs and crunching snow, I followed noiselessly. The trail crossed the old wagon road and led up a slight knoll, then turned abruptly. I had not gone far on this knoll when I heard bushes moving on my right. I settled down on my knees right where I was, but try as I would nothing could be seen of the elk. I thought of waiting until he moved, as there were openings in which he might appear, but I was too impatient to wait, and besides he might have gone straightaway. I worked toward him as carefully as if he had been a weasel that I hoped to catch asleep. As I drew nearer, the uncertainty of the sequel because of the disproportion between the game and my gun gave me some little apprehension and my heart was hitting my slats pretty hard.

"I know I opened the gun once to be sure it was loaded and I held the usual supply of cartridges in my mouth. I must have got within 40 yards of that fellow; I could make out a leg and had him covered, ready to shoot the instant I could distinguish a vital spot. He was moving when I fired. Down he went in a heap, but was up and off instantly. I fired again where I had last seen him. There was blood where he fell. I hurried along on

his trail, and in places the snow was crimson with blood that spurted at each bound from his left side. Down the slope he ran, straight ahead, a sure sign of a speedily fatal wound. Presently I came up to my game and found—a female mule deer!

"Investigation proved that I was on an elk's trail when the doe attracted my attention. My expectation of seeing an elk was so fixed that I would probably have fired at a horse or cow. I remembered having heard a crash or 2 behind me at the time I fired. Going back, I found that the elk was really as near as the deer at the time I left the trail. He had been standing near a cluster of chaparral, some 2 rods across, and lunged straight through it."

I received my premium, a Poco camera, all right and it is a fine instrument. I have already used it with great success. We who live in the home of the world's camera industry know a good thing when we see it, and that is why we all subscribe for RECREATION.

Fred V. Love, Rochester, N. Y.

Wife—Before we were married you pretended that you liked to have me sit on your knee.

Husband—Well, you were a pretty good pretender yourself. You pretended that you preferred to sit on a chair.—Chicago News.

I beg to acknowledge the receipt of the 11-foot special King canvas folding boat. It is well made and of splendid design. I find it a handy little boat for duck hunting. Please accept my many thanks.

H. H. Dean, Leavenworth, Wash.

I received the Yawman & Erbe automatic reel, style B, and a 14-foot King folding boat and I like them very much. The boat is a complete thing for pleasure.

C. E. Hale, Montpelier, Ida.

I received the Ithaca gun you had sent to me. From the targets it makes I consider it one of the best of guns. I am much pleased with it, and you have my sincere thanks.

T. R. Navarre, Monroe, Mich.

"Her husband is a thousand times too good for her."

"Poor thing, she has my sympathy! I have the same sort of husband myself."—Town Topics.

I should like to see every man who carries a gun a subscriber to RECREATION. Its methods are drastic and it accomplishes much good.

Dr. W. G. Fanning, Lubec, Me.



SHREDDED WHOLE WHEAT Made in two forms: *Biscuit* and *Triscuit*.
 The only light and porous foods made from wheat without the use of fats, yeast or chemicals of any kind. Made in the most Hygienic and Scientific Food Laboratory in the world, a Veritable Home of Purity, a place where contamination cannot occur.

Shredded Whole Wheat Biscuit is the standard all-day cereal and makes appetizing combinations with fruits, preserves or vegetables—250 varieties of all-course dishes.

Triscuit, the New Cracker, is so baked by electricity that all the rich, nutty flavor of the whole wheat is retained. Served with soups, preserves or cheese. Replaces crackers, bread, toast and wafers.

HEAT BEFORE EATING.

"I most cheerfully indorse Shredded Wheat as a healthy and highly nutritious food. Especially is it adapted for those suffering with weak digestion and mal-assimilation."
 W. Carey Allen, M. D., Colorado Springs, Colorado.

Sent FREE, our beautiful illustrated cook book, "The Vital Question."

The Natural Food Company,

Makers of Shredded Whole Wheat Products

Niagara Falls, New York.

To
 The
 Natural
 Food Co.,
 Niagara Falls,
 New York.

Please send, free of cost to the address below, "The Vital Question Cook Book."

OUT ON THIS LINE

Name.....

Address.....

Rec. March

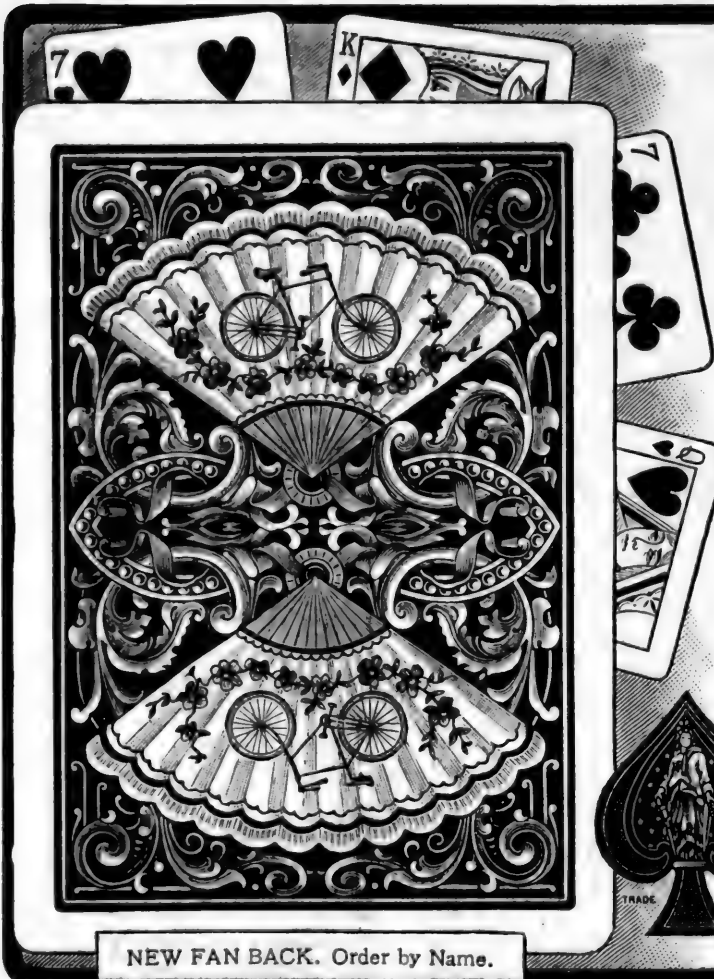

Bicycle Cards wear well.

Delightfully nice to shuffle and deal. Smooth, highly polished, full of snap, up-to-date designs Sold by dealers everywhere.

The U. S. Playing Card Co.
Cincinnati, U. S. A.

HOYLE for 10c. In stamps—128 pages. Address Dept. 23

For Duplicate Whist, best of card games, use Paine's Trays Lessons free with each set of trays. Write for particulars.

NEW FAN BACK. Order by Name.

I received the Shakespeare level winding reel. The spooling attachment is fine; so is the adjustable drag. I do not see how you can give such an expensive reel as a premium for only 15 subscriptions.

Wm. A. Nyce, Jr., Poughkeepsie, N. Y.

I received the West End gun cabinet O. K. I thank you heartily. It is a fine piece of work. One pleasure in working for you is that when we earn a premium it is always all right.

Sam Overfield, Fort Scott, Kans.

RECREATION is the best magazine of the kind published.

William Whyte, Globe City, Ariz.

I appreciate what you have done for Blair county in catching the dynamiters. I think you were wide awake when you traced them up. I hope they left enough fish behind for me to test the new rod you sent me.

Ross W. Huber, Altoona, Pa.

He—Good heavens, dear! The clock just struck one, and I promised your mother I'd go at 12.

She (comfortably)—Good! We've got 11 hours yet.—Life.

RECREATION is my favorite magazine.

E. T. Grandlineard, Plain View, L. I.

A REMARKABLE OFFER — A SURPRISE TO YOU — A TREAT

Three Splendid Books—167 pages each, in all 500 pages. Over 1,000 Illustrations

For Sportsmen
Hunters
Shooters
Fishermen
Anglers
Trappers
Campers Out

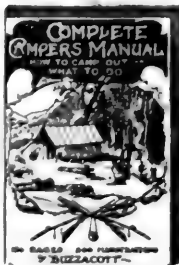

CAMPING

A Veritable Sportsman's Complete Library

The Sportsman's Pocket Encyclopedia of Useful and Instructive Information.

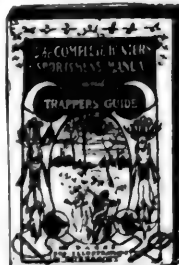

HUNTING

Twentieth Century Books that will Surprise You



FISHING

Send ten (10c.) cents in coin or stamps for either of the books, or thirty (30c.) cents for the three books

See our World's Fair Exhibit, St. Louis, Mo Address, "BUZZACOTT," Racine Junction, Wis.

ELK ON THE CLEARWATER.

Mr. Carlisle and I left Kamah August 20 with 4 ponies—2 pack and 2 saddle—crossed the Clearwater river and camped the first night at Mussel Shell on the Lo Lo trail. We were 7 days reaching the hot springs on the Locksaw and Jerry Johnson's cabin. We spent 2 days there. September 1 we crossed the Locksaw and went to Bare Gross camp, where we were joined by 7 other hunters.

On a saddle of the mountain we saw fresh elk sign and found where a bull had wallowed in the mud. A few hundred yards farther on we found the bunch feeding. Mr. Carlisle selected a big bull and dropped him at the first shot. I arrived in time to help finish another large bull, and I shot a yearling for camp meat. Could have shot some cows at short range, but did not go into the woods to kill cow elk, does or fawns. The next day we took in our elk and divided the meat with the party camped near us. We retained the heads.

The country is rough and there being much fallen timber, it is difficult to travel; yet I think it is the best country in the United States for big game. I do not advise any one to stay longer than October 1, as the snow falls deep and early. If any reader of RECREATION is thinking of going in, I should be glad to give him any information wanted.

W. J. Davidson, Oakesdale, Wash.

A Fountain Pen

has become a necessity with every business man. You can get a

**Laughlin
Fountain
Pen**

Made by the Laughlin Manufacturing Co.
Detroit, Michigan

**For 2 Yearly Subscriptions
to RECREATION.**

And you can get these 2 subscriptions in 20 minutes, any day.

The Laughlin is one of the best pens in the market, and thousands of them are in daily use.

There is no reason why you should be without one.

**Sample Copies of Recreation for
Use in Canvassing
Furnished on Application**

**Malt Is The
Soul of Beer**

In Pabst Blue Ribbon Beer you have a malt made from northern grown barley by a process that represents the highest attainment in modern malting.

Behind it is the fame of Pabst and sixty years of practical experience in brewing. It is the life of the barley grain caught and blended with the choicest hops under conditions that make

**Pabst
Blue Ribbon**

The Beer
of Quality



superior to other table beers for quality and wholesomeness. Pabst has developed many ingenious mechanical devices for insuring the absolute purity of the product. Many processes commonly used in brewing were discarded by Pabst years ago as old-fashioned and out-of-date.

Eleven years ago Pabst discarded the process of cooling beer in plate-glass chambers, of which he was the originator and inventor. Pabst beer is now cooled in hermetically sealed rooms with filtered air. Pabst Blue Ribbon is a malty beer, exquisite in flavor, and full of health and strength.

THE COLT Automatic Pistol

Fires 7 Shots in 2 Seconds

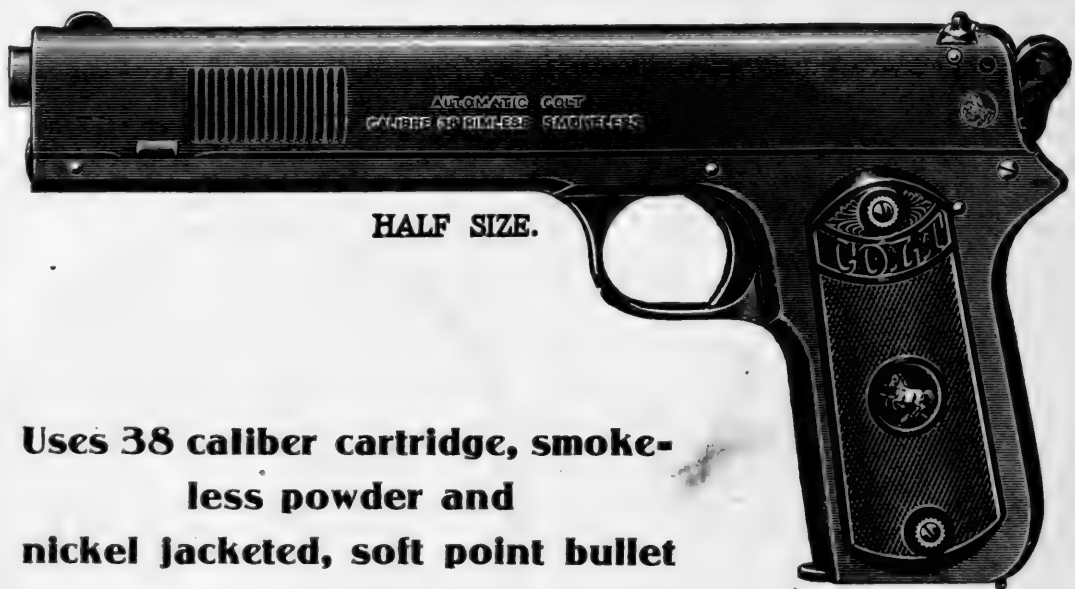

**Uses 38 caliber cartridge, smoke-
less powder and
nickel jacketed, soft point bullet**

Lists at \$25

I have contracted for a lot of these revolvers at a price that enables me to offer you one as a premium for

50 Yearly Subscriptions To RECREATION

SEND FOR PACKAGE OF SAMPLE COPIES FOR USE IN CANVASSING

FRENCH — GERMAN — SPANISH

SPOKEN TAUGHT MASTERED

LANGUAGE-PHONE METHOD

Combined with DR. RICHARD S. ROSENTHAL'S METHOD OF PRACTICAL LINGUISTRY

No longer unnecessary memorizing of verbs, declensions or rules. You hear the exact pronunciation of each word and phrase thousands of times if you like. It requires but a few minutes' practice in spare moments to acquire a thorough mastery of conversational French, German or Spanish. College professors all over this and other countries, and the press generally, endorse this perfect and natural system of teaching languages. Send for testimonials, booklet, and letter telling all about this 20-century scientific marvel.

INTERNATIONAL LANGUAGE-PHONE METHOD, 1116 Metropolis Bldg., B'way & 16th St., N. Y.

Hypnotism

FREE—Would you achieve business and social success; improve your talents; gratify your ambitions; cure diseases and bad habits, and wield wonderful power and influence over others? If so, write for our book—by thirty eminent specialists. It thoroughly explains all the hidden secrets of **Hypnotism, Personal Magnetism, Magnetic Healing, Etc.** It is the most remarkable work of the century. Positively nothing like it ever before published. It has brought success to thousands. We guarantee success to you or forfeit \$1,000.00 in gold. **The book is free.** A postal card from you to-day brings the book to-morrow. Address,

American College of Sciences
 Dept. 104 E ROCHESTER, N. Y.

MOJAVE INDIAN BEAD WORK.

For each yearly subscription to RECREATION sent us we will send by mail, postpaid, a Beaded Watch Fob, made by the Mojave Indians. For 3 yearly subscriptions we will send a fine Beaded Belt, 24 inches or more in length and made in beautiful design with mild color combinations. We also have other Indian work to offer for subscriptions.

State color desired; can furnish almost anything from large stock.

Mojave Indian Trading Co.,
 Mellen, Mohave Co., Arizona.

Tommy—The teacher wanted to box my ears this morning.

Grandma—How did you know he did?

Tommy—'Cause he wouldn't have boxed 'em if he hadn't wanted to!—Chicago Journal.

He—How long have you been learning to skate?

She—Oh, about a dozen sittings.—Life.

A REMARKABLE OFFER

3 Splendid Books 500 Pages, 1,000 Illustrations on Fishing, Hunting, Camping.

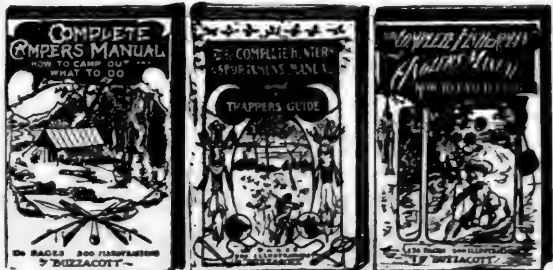

The three books in all 500 Pages, now ready. A Complete Sportsman's Library. Send 10c. in coin or stamps for either Book, or 30c. for the three books. Address, "BUZZACOTT," Racine Junction, Wis.

NOW DEPOSITED IN THE BANK

\$75,000.00

IN CASH GIVEN AWAY.

To arouse interest in, and to advertise the **GREAT ST. LOUIS WORLD'S FAIR**, this enormous sum will be distributed. Full information will be sent you **ABSOLUTELY FREE.** Just send your name and address on a postal card and we will send you full particulars.

World's Fair Contest Co.,
 108 N. 8th Street
 St. Louis, Mo.

\$5.75 PAID FOR RARE 1853 QUARTERS; \$4 paid for 1804 dimes; \$15 paid for 1858 dollars; big prices paid for hundreds of other dates; keep all money coined before 1879 and send ten cents at once for a set of two coin and stamp value books. It may mean a fortune to you. Address C. F. Clarke, Agent, LeRoy, N. Y., Dept. 3.

No. 58



No. 34



Here is a Knife Men Love so much they hate to throw an old handle away.

THIS IS TEDDY'S CAMP KNIFE.

No. 58. Cut is exact size; ebony handle, 3 blades, German silver end. The long blade is for rough or fine work; the medium blade is as thin as a razor. Price, postpaid, \$1.00.

No. 34 we call "Our Masterpiece," weighs only 2 ozs., 3 cutting blades; will cut a quill pen or an ax-handle; price, with ebony handle, postpaid, \$1.25; Ivory, \$1.50; choicest pearl, \$2.00.

Our 2 blade Jack Knife sells at 75c; our special price is 48c., postpaid, 5 for \$2.00. All our blades file-tested; warranted; replaced free if soft or flaky. Barber's hollow ground Razor and Strap to suit, \$1.25.

Send for free 80-page list and "How to Use a Razor."

Maher & Grosh Co.
 74 A Street, Toledo, Ohio

SOME RARE OPPORTUNITIES

These goods are all new, and will be shipped direct from factory. Prices named are those at which manufacturers and dealers usually sell. Here is a good chance to get

A Book, a Gun, a Camera
A Sleeping Bag, a Fishing Rod
A Reel, a Tent, } FREE OF COST

Subscriptions need not all be sent at once. They may be sent in installments as taken and credit will be given on account. When the required number is obtained the premium earned will be shipped.

TO ANY PERSON SENDING ME

TWO new yearly subscriptions to RECREATION at \$1 each, I will send a copy of *Hunting in the Great West*, cloth; or an Ingersoll Watch or Cyclometer, listed at \$1; or a Recreation Waterproof Match Box, made by W. L. Marble and listed at 50c; or a Shakespeare Revolution Bait listed at 75 cents; or a Laughlin Fountain Pen; or a dozen Trout Flies, assorted, listed at \$1; or a pair of Attachable Eyeglass Temples, gold-plated, made by Gall & Lembke; or one Rifle Wick Plug, made by Hemm & Woodward, Sidney, Ohio, 30 caliber to 50 caliber, or Shotgun Wick Plug, 20 gauge up to 10 gauge, or a pair of chrome tanned horsehide hunting and driving gloves, listed at \$1.50, made by J. P. Luther Glove Co.

THREE new subscriptions at \$1 each, a safety pocket ax, made by W. L. Marble and listed at \$2.50; or a dozen Bass Flies, assorted, listed at \$2; or a pair of Shotgun Wick Plugs made by Hemm & Woodward, Sidney, Ohio, 20 gauge to 10 gauge; or a Polished Buffalo Horn Gun Rack, made by E. W. Stiles; or a pair of gauntlets, for hunting and driving, ladies' size, listed at \$2.50, made by J. P. Luther Glove Co., or a Press Button Jack Knife, made by The Novelty Knife Co., and listed at \$1.

FOUR new subscriptions at \$1 each, an Ideal Hunting Knife, made by W. L. Marble and listed at \$2.50; or a 32 caliber, automatic double action revolver, made by Harrington & Richardson Arms Co.

FIVE new subscriptions at \$1 each, a copy of *Cruisings in the Cascades*, cloth; or a set of Nehring's Convertible Amplisopes, listed at \$5.00; or an Ideal Hunting Knife made by W. L. Marble, and listed at \$3; or a pair of lock lever skates, made by Barney & Berry, listed at \$4.50; or a J C Hand trap made by the Mitchell Mfg. Co., listed at \$4.; or a Bristol Steel Fishing Rod, listed at \$6, or less; or a Yawman & Erbe Automatic Reel, listed at \$6 to \$9.

SIX new subscriptions at \$1 each, a Hawkeye Refrigerating Basket made by the Burlington Basket Co., or one dozen Eureka golf balls listed at \$4; or a Pocket Poco B 3 1/4 x 4 1/4, made by the Rochester Optical Co., listed at \$9.

SEVEN new subscriptions at \$1 each, a copy of *The Big Game of North America*, or of *The American Book of the Dog*, cloth, or one set Lakewood golf clubs, 5 in number, listing at \$5; or a series 11F Korona Camera, made by the Gundlach Optical Co., listed at \$10.

EIGHT new subscriptions at \$1 each. A series 1, 4x5, Korona Camera, made by the Gundlach Optical Co., listed at \$12, or an Acme single shot gun, made by the Davenport Arms Co., and listed at \$8.

TEN new subscriptions at \$1 each, a Cut-Glass Salad Bowl, made by Higgins & Seiter, and listed at \$4.50; or a Waterproof Wall Tent 7 x 7, made by Abercrombie & Fitch, and listed at \$8; or a Rough Rider rifle telescope; made by The Malcolm Rifle Sight Mfg. Co., and listed at \$12; or a Pneumatic Camp Mattress, listed at \$18; or a pair of Opera Glasses made by Gall & Lembke and listed at \$10.

TWELVE new subscriptions at \$1 each, a Davenport Ejector Gun, listed at \$10., or a Cycle Poco No. 3, 4x5, made by the Rochester Optical Co., listed at \$15; or an 8 ft. folding canvas boat, made by the Life Saving Canvas Boat Co., listed at \$29.

FIFTEEN new subscriptions, \$1 each, a Shakespeare Reel, Silver Plated, listed at \$15; or a set of rabbit plates made by Higgins & Seiter, and listed at \$8; or a Field Glass made by Gall & Lembke; or a Kenwood Sleeping Bag, complete, with canvas cover, listed at \$16; or a Bulls-Eye rifle telescope, made by The Malcolm Rifle Sight Mfg. Co., and listed at \$16; or a 10 ft. special canvas boat, made by the Life Saving Canvas Boat Co., and listed at \$35; or a pair of horsehide hunting boots, listed at \$10.

TWENTY new subscriptions at \$1 each, a 14-karat Gold Hunting-case Watch, with Waltham Movement, listed at \$20; or an Elita single shot gun, made by the Davenport Arms Co., and listed at \$18., or an Acme Folding Canvas Boat, No. 1, Grade A, listed at \$27; or a Mullins Duck Boat, listed at \$20.

TWENTY-FIVE new subscriptions at \$1 each, A 4 x 5 Planatic lens, made by the Rochester Lens Co., and listed at \$45; or a 11-foot King Folding Canvas Boat, listed at \$38.

THIRTY new subscriptions at \$1 each, a Waterproof Tent, 14 1/2 x 17, made by Abercrombie & Fitch, and listed at \$25.

THIRTY-FIVE new subscriptions at \$1 each, a 14-ft King Folding Canvas Boat listed at \$48.

FORTY new subscriptions at \$1 each, a Savage .303 Repeating Rifle; or a No. 10 Gun Cabinet, made by the West End Furniture Co., and listed at \$32.

FIFTY new subscriptions at \$1 each, a No. 20 Gun Cabinet, made by the West End Furniture Co., and listed at \$38; or a Colt Automatic Pistol, made by the Colt's Patent Fire Arms Mfg. Co., and listed at \$25.

TWO HUNDRED new subscriptions at \$1 each, a strictly first class upright piano, listed at \$750.

Address, **Recreation** 23 West 24th St.
New York

"I Grow Hair"

Famous Doctor-Chemist Has Discovered a Secret Compound that Grows Hair on any Bald Head



This Magic Compound Never Falls to Grow Hair

He sends a trial package of his new and wonderful remedy free by mail to convince people it actually grows hair, stops hair falling out, removes dandruff and quickly restores luxuriant growth to shining scalps, eyebrows and eyelashes and restores the hair to its natural color. Send your name and address to the Altemheim Medical Dispensary, 1303 Foso Building, Cincinnati, Ohio, for a free trial package, enclosing a 2-cent stamp to cover postage. Write to-day.

Something Special — Playing Cards Free:—To each person sending me \$1 for one year's subscription to RECREATION, or sending it direct to be placed to my credit, I will forward, all charges prepaid, a pack of elegant gold edge playing cards. These are no cheap second quality cards but first quality of extra selected stock, highlyenameled and polished, fancy set pattern backs, each pack wrapped in handsome glazed wrapper and packed in strong telescope case. L. J. Tooley,

141 Burr Oak St., Kalamazoo, Mich.

ARNICA Tooth Soap the International Dentifrice

Beautifies the teeth, hardens the gums, sweetens the breath. Preserves as well as beautifies the teeth. Comes in neat, handy metal boxes. No powder to scatter, no liquid to spill or to stain garments.

25 Cents

At all Druggists.

C. H. STRONG & CO., Proprietors,
Chicago, U. S. A.



When a Woman Suffers

Modesty too often keeps her from a physician and allows desperation to lead her to habit-forming drugs or mineral poisons. Mothers with growing girls should especially guard them against such dangers. If every woman knew the marvelous virtues of that good old family doctor—*Pond's Extract*—much suffering would be saved. The powerful anodyne (pain relieving), astringent (healing) and antiseptic action of Pond's Extract work a reorganization of the functions almost beyond belief. To acquaint every woman and mother with this secret of Pond's Extract we have published a small book on the safe and sensible treatment of such disorders, well worth asking for and reading. *It's free.*



CAUTION

Beware of the witch hazel snare. There is nothing the same as Pond's Extract. Sold only in sealed bottles under buff wrappers.

Pond's Extract Co., New York.

FREE

Until Cured



To men who suffer any personal weakness of whatever nature, the effects of indiscretions, overwork, exposure or excesses, varicocele, or from rheumatism, lame back, lumbago, kidney, liver or stomach complaints, I, beginning with this month, have this proposition to make: I will give you the use of my world-famed Dr. Sanden Electric Belt free until you are cured, and will not ask one cent in advance or on deposit. The price of my belts is from \$4 up, and when cured you pay the price of same, and no more, and not until then. The advice and guidance I will give you until your health is regained, is from nearly 40 years' successful experience, and will cost you nothing.

My reason for making this offer is simply to convince skeptics of my faith in my treatment. I have a remedy that I know will do what I claim for it, and from my knowledge of sportsmen feel safe in leaving it to their honor to do right by me if I do right by them.

I have two best little books ever written upon electricity and its medical uses, and even if you don't need or wish to try my treatment, they will interest and instruct you.

Write today for my treatment and books, free, by mail, sealed.

DR. G. B. SANDEN

1155 Broadway,

New York

KEEP YOUR HANDS WARM

Send me 2 yearly subscriptions to **Recreation** and I will send you a pair of **Leather Hunting Gloves** made to your measure, by the **Luther Glove Co., Berlin, Wis.**

Sample copies for use in canvassing furnished on request

Taxidermy Free to Subscribers of Recreation.

To any person sending me \$1 for 1 year's subscription to RECREATION I will mount free of charge any bird up to and including the size of a robin, blue jay, etc. For 2 subscriptions I will mount birds the size of screech owl, quail, etc. For 3 subscriptions I will mount birds the size of ruffed grouse. For 4 subscriptions, red tail hawk, wood duck, etc. For 5 subscriptions, brant, fish hawk, etc. For 6 subscriptions, great horned owl, etc. For 7 subscriptions, great blue heron, etc. For 10 subscriptions, swan, pelican, eagle, wild turkey, etc. For 15 subscriptions I will mount a deer head. Or any person sending me work to the amount of \$10 or more I will give RECREATION for one year. Prices given on application and all work guaranteed. The subscriber must pay express both ways. Here is a chance for sportsmen to decorate their dens with trophies free of cost.

A. W. Perrior, 316 E. Kennedy St., Syracuse, N. Y.

Free: To any one sending me 5 subscriptions to RECREATION, I will give 1 pair Snowshoe Rabbits or will sell for \$4 a pair. **Stanley L. Trees, Tie Siding, Wyoming.**



H. J. TILLOTSON, M. D.
The Master Specialist of Chicago, who Cures Varicocele,
Hydrocele, and treats patients personally.
 Established 1880.
 (COPYRIGHTED)

Varicocele Hydrocele

Cured to Stay Cured in 5 Days.
No Cutting or Pain. Guaranteed
Cure or Money Refunded.

VARICOCELE. Under my treatment this insidious disease rapidly disappears. Pain ceases almost instantly. The stagnant blood is driven from the dilated veins and all soreness and swelling subsides. Every indication of Varicocele vanishes and in its stead comes the pleasure of perfect health. Many ailments are reflex, originating from other diseases. For instance, innumerable blood and nervous diseases result from poisonous taints in the system. Varicocele and Hydrocele, if neglected will undermine physical strength, depress the mental faculties, derange the nervous system, and ultimately produce complicated results. In treating diseases of men I always cure the effect as well as the cause. I desire that every person afflicted with these or allied diseases write me so I can explain my method of cure, which is safe and permanent.

My consultation will cost you nothing, and my charges for a perfect cure will be reasonable and not more than you will be willing to pay for the benefits conferred.

Certainty of Cure is what you want. I give a legal guaranty to cure or refund your money. What I have done for others I can do for you. I can cure you at home

Correspondence Confidential. One personal visit at my office is preferred, but if it is impossible for you to call, write me your condition fully, and you will receive in plain envelope a scientific and honest opinion of your case. Free of charge. **My home treatment is successful.** My books and lectures mailed free upon application.

H. J. TILLOTSON, M. D., 140 Tillotson Bldg, 84 Dearborn St., CHICAGO

DO YOU WISH TO IMPROVE YOUR SHOOTING? IF IT IS AS GOOD AS IT CAN BE, DO YOU WISH TO KEEP IT SO? IN EITHER CASE, THE J. C. HAND TRAP WILL BRING WITHIN YOUR REACH THE FULL ADVANTAGE OF A SHOOTING RANGE. THESE TRAPS WILL SUCCESSFULLY THROW ANY OF THE CLAY TARGETS NOW IN USE, GIVING A LIFE LIKE REPRESENTATION OF A BIRD IN FLIGHT. I WILL SEND YOU A J. C. HAND TRAP FOR 5 YEARLY SUBSCRIPTIONS TO RECREATION. SEND IN YOUR CLUB NOW, AND IMPROVE ON YOUR SHOOTING.



Club Cocktails

Famous the world over for purity. They never vary. The secret of their perfect blend is that they are kept six months before being drawn off and bottled. Be sure you have them in your camp, on the yacht, and on your outing trips wherever you go. They are ready and require no mixing. Simply pour over cracked ice.

For Sale by all Fancy Grocers and Dealers

G. F. HEUBLEIN & BRO.
 29 BROADWAY, N. Y. HARTFORD, CONN.

F O R
Solid Comfort
 SUMMER or WINTER

The
 Best
 is
 the
 Cheapest



Get a pair of
**Thompson-
 Quimby
 Hunting
 Boots**

I Make the Best

All work guaranteed. I refer by permission to the Editor of RECREATION. Measurement blanks and prices on application. Mention RECREATION.

T. H. GUTHRIE

33 William St.

NEWARK, N. J.

**Sportsmen's
 Show**

**MADISON
 SQUARE
 GARDEN**
 New York City

**Feb. 19 to March 5
 1904**

For further information, floor plans, etc., address

Sportsmen's Exhibition Co.
 1123 Broadway, New York City

**Paroid
 Roofing**

"IT LASTS"

The most economical roofing made. Does not require a skilled roofer. Easy to apply with roofing kit in each roll. No repairs. No paint required when first laid.

F. W. Bird & Son

Makers

EAST WALPOLE, MASS.

New York Washington Chicago

**Are You an Amateur
 Photographer?**



If so, would you like a Camera that will photograph

- A whole range of mountains
- A whole sweep of river
- A whole army
- A whole fleet of ships
- A whole city

Or any other vast stretch of scenery or moving objects? **THE SWING LENS DOES IT.**

The AL VISTA

Is the thing

One of the greatest inventions of the age.

*I will give you a No. 5-B as a premium for
 12 subscriptions. For particulars address*

**Recreation, 23 West 24th St.
 New York City**

MARGERY DAW (TRUE VERSION)

See, saw, Margery Daw
Sold her bed and lay on straw
The bed she sold was made of hair
And germs and dirt abounded there
So Margy with great wisdom saw
That hair for beds was worse than straw!

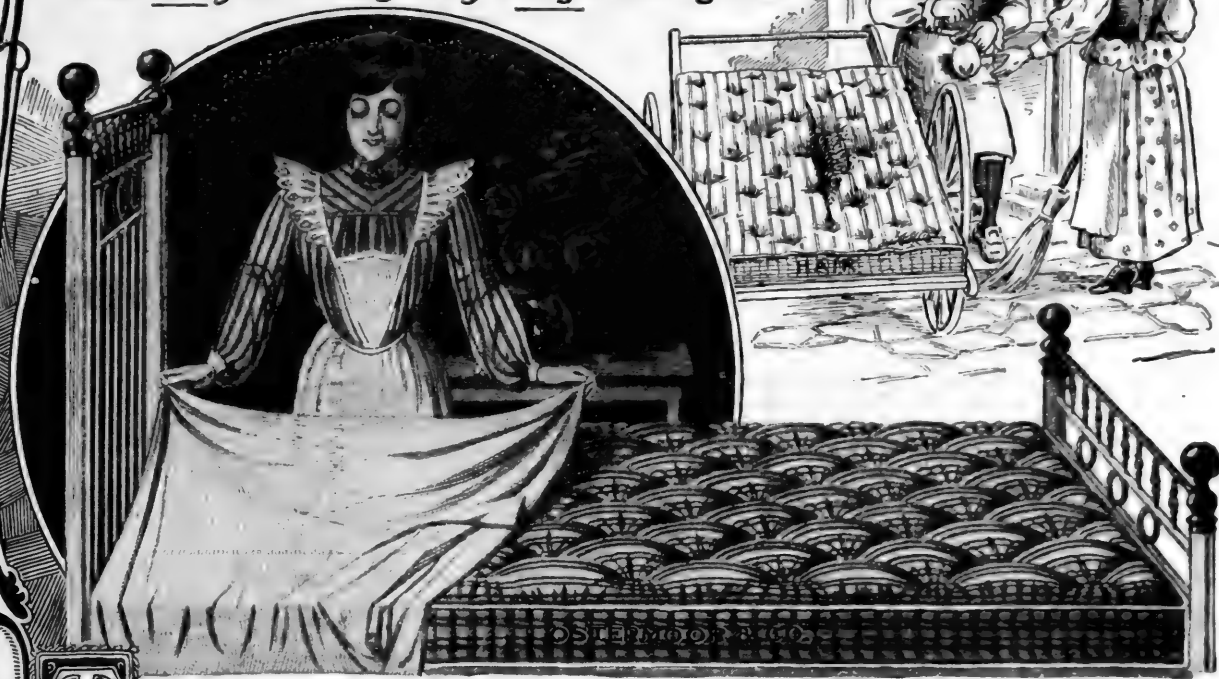

To Margeries of the present day who dislike dirt, we simply say
The *cleanest* bed on sea or shore is the ANTISEPTIC OSTERMOOR.

Please remember that no one can make mattresses of "felt," "elastic felt," or "patent elastic felt" but Ostermoor & Co. Our name and guarantee on every genuine mattress. It's not *felt* if it's not an *Ostermoor*. The

"Ostermoor" Patent Elastic Felt Mattress \$15.

never has to be made over—being made right in the beginning it stays right to the end. It will last so long that you will forget the price but not the quality. It is in every way unique—its comfort, its cleanliness, its economy. Even the most pronounced pessimist cannot find an objection to this peerless bed. Surely no one can find fault with our offer of

Thirty Nights' Free Trial

Sleep on it 30 nights, and if it is not even all you have *hoped for*, if you don't believe it to be the equal in cleanliness, durability and comfort of any \$50. hair mattress ever made, you can get your money back by return mail—"no questions asked." There will be no unpleasantness about it at all.

STANDARD SIZES AND PRICES:

2 feet 6 inches wide, 25 lbs.,	- - -	\$ 8.35
3 feet wide, - 30 lbs.,	- - -	10.00
3 feet 6 inches wide, 35 lbs.,	- - -	11.70
4 feet wide, - 40 lbs.,	- - -	13.35
4 feet 6 inches wide, 45 lbs.,	- - -	15.00

All 6 feet 3 inches long.
In two parts 50c. extra Special sizes, special prices.
Express charges prepaid to any place.

SEND FOR OUR FREE BOOK

It will be worth your while—your name on a postal will do. It is conceded one of the hand-somest advertising books ever made; 96 pages; cover in colors; beautifully illustrated. We want you to look it through even if you may *never* buy from us. Mattresses shipped, express prepaid, same day check is received.

We have cushioned 25,000 Churches. Send for free book, "Church Cushions."

OSTERMOOR & COMPANY, 114 Elizabeth St., New York.

The Alaska Feather and Down Co., Ltd., Montreal
Canadian Agents.



The Western Recreation Launch



ABSOLUTE LAUNCH SATISFACTION

Is contained in the "Western Recreation." It possesses those essential points, Grace, Beauty of Outline, Symmetry, Simplicity and Safety. Speed is there too if you want it. Most reasonable in first cost, most economical to maintain.

THE BEST FINISHED, HANDSOMEST, MOST RELIABLE.

We build them with either Torpedo or Semi-Elliptic Hulls, and in completeness, it is the ideal and dependable craft for both pleasure and security.

The Western Marine Engine Will please those who build their own hulls. Beautiful Art Catalog describing our Launches and Marine Engines sent upon receipt of 10c. Catalog L.

Western Launch and Engine Works, ^{No. 12} LINN ST., Mishawaka, Ind.

A SPORTSMAN'S BOAT

Mullins' "Get There" Steel Duck Boat

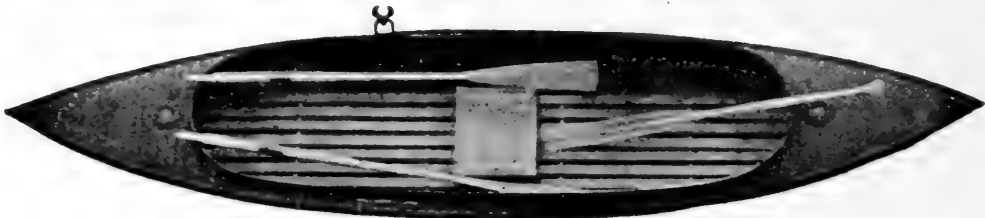

14 ft. long, 36-inch beam. **PRICE, \$20** Crated on cars Salem.

Endorsed by Thousands of Sportsmen. Air Chamber each end. Always ready. No repair
Send for handsome free book. Mention RECREATION.

W. H. MULLINS, 228 Depot Street, Salem, Ohio

A Press Button Hunting Knife

Is one of the best articles a hunter ever carried

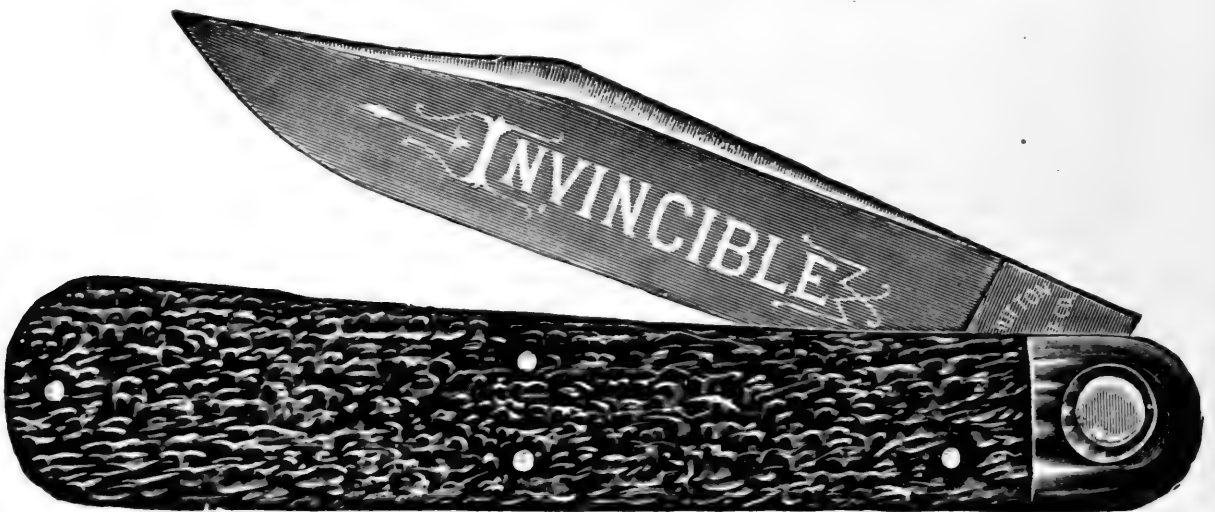

It has a 4 Inch Blade made of the Best Silver Steel

The knife cannot come open in your pocket. It cannot close on your hand when in use. It opens and closes only when

YOU PRESS THE BUTTON

If you once use one of these knives you will never use any other. You can get one as a premium for

3 YEARLY SUBSCRIPTIONS TO RECREATION

Sample Copies furnished on request.



If you want both style and durability get a

Matthews Torpedo Launch

Built after the most approved models.

Any power or motor desired installed.

Send for our free booklet of **MARINE LAWS AND TABLES.**

Mention
RECREATION

Matthews Boat Co.

BASCOM, OHIO, U. S. A.

SMALLEY MARINE GAS ENGINES

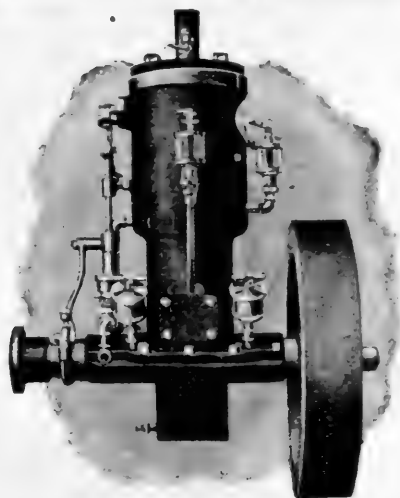

Designed for use in any kind of a boat requiring from 1½ H. P. to 20 H. P. Either single or double cylinder. Simple, mechanical, handsome, durable, positive, economical, and moderate priced. Our speed control, propeller equipment, and many other features should be investigated. **OUR NEW PLANT** is the largest in the world devoted exclusively to the manufacture of Marine Gasoline Engines. We operate our own pattern, foundry, forge, and machine departments. We manufacture every part of our engines, from fly wheel to propeller.

Every engine is connected to its propeller and given an actual water test before placed in purchaser's hands.

SEND FOR ILLUSTRATED CATALOGUE. ADDRESS DEPT. C
Smalley Motor Co., Ltd., Bay City, Mich., U.S.A.



11-foot Special

used by the U. S. Navy. They are simple, wonderful. A thoroughly patented article. Beware of imitations. Made only by ourselves. *A catalog of 100 engravings and 400 testimonials sent on receipt of 6 cents.*

Bottom Boards rest on the frame, not on the canvas, ribbed longitudinally and diagonally. They are *stiffer and safer* than a Wooden Boat because the lines are fuller, and are much easier to row or paddle.

KING FOLDING CANVAS BOAT CO.

Mention RECREATION.

KALAMAZOO, MICH., U. S. A

Folding Canvas Boats

were not satisfactory until the

KING

was produced. It's a revelation in boat construction, nothing like it ever made. *Nonsinkable Can't tip over. Puncture Proof, wear longer than a wooden boat. No repairs. No cost for storage, always ready, folds into a small neat package, carry by hand,*

D. M. TUTTLE CO.

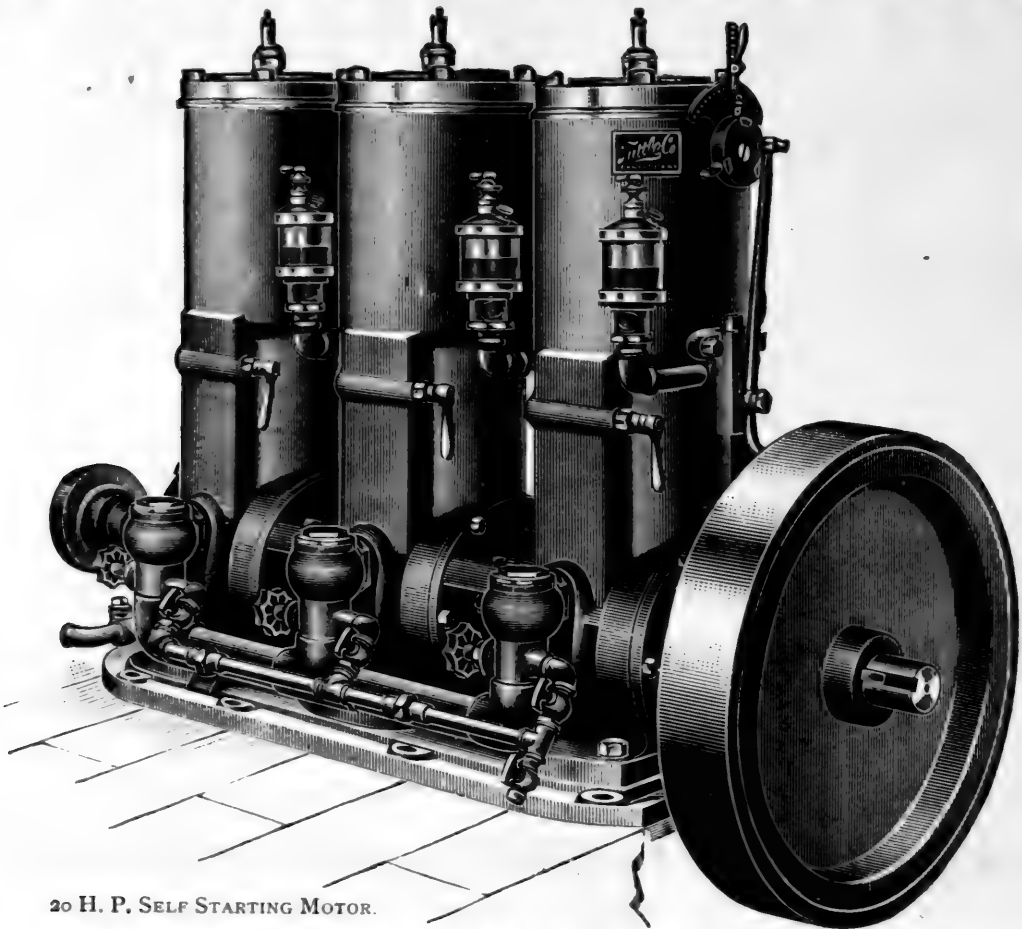

20 H. P. SELF STARTING MOTOR.

GASOLINE MOTORS AND LAUNCHES

THE above is a cut of our 3 cylinder self starting and reversible jump spark motor. With the cylinders once charged with the explosive mixture, the motor may be left for hours, after which it can be started, in either direction, by simply moving the lever attached to the commutator at top of front cylinder in the direction desired. The motor always comes to rest with one piston at the bottom of its stroke, with the other two on opposite side of crank shaft, with fresh charge partly compressed. The firing of either of these charges will start the motor, the direction being under control of the operator. The moving of the lever in either direction brings the segment in face of commutator in contact with brush in eccentric arm so as to ignite either charge, independently of moving the balance wheel. This lever also controls the time of ignition, which can be increased or retarded at the operator's will, allowing the motor to be slowed down to its minimum speed without use of throttles.

The two cylinder motors with this attachment are also self starting and a crank is not necessary as both can be started when cold by simply priming with gasoline and rocking the balance wheel to mix up charge and then making connection by means of the lever.

Motors from $1\frac{1}{2}$ H. P. to 20 H. P., one, two, three and four cylinders.

LAUNCHES



From 15 to 50 ft., Open, Half and Full Cabin. Any model. *Send for Illustrated Catalogue.*

D. M. TUTTLE CO., 10 Pine St., CANASTOTA, N. Y.

Fay & Bowen Motors & Launches

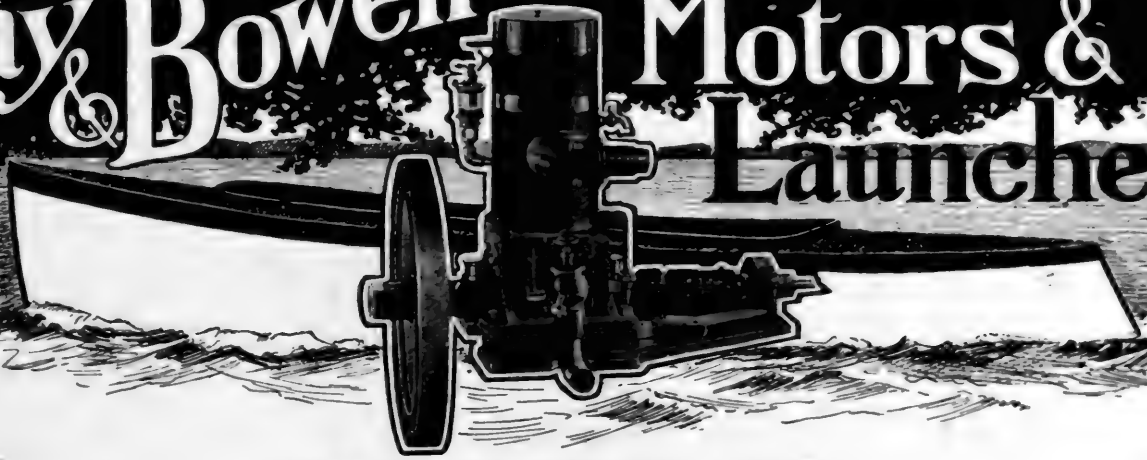

OPERATED BY GASOLINE VAPOR

The Fay & Bowen Marine Motor is a revelation to those who have used others. Reliable, safe, durable and easy to operate. Remarkable speed control. Best of all, it starts when you start it. No handle or crank is used. Our patent igniter is absolutely unique and always instant and positive in action. It is really the only perfect and satisfactory igniter.

Motors complete from 1½ to 25 actual Horse Power ready for installation.

We also build a line of the finest launches afloat, complete and with our motor installed and all ready to run. We make these in either the usual round stern model or our flat stern torpedo model in lengths from 18 to 35 feet. We can furnish large cabin launches on special order. For excellence of workmanship and beauty of finish and design our boats are unsurpassed. Ask for description of our fast torpedo outfits.

Send for Catalogue and live testimonials from satisfied customers. Our customers are our best advertisers.

FAY & BOWEN, 28 Mill Street, Auburn, New York

He—Yes, I remembered you at once as the girl I was engaged to in the mountains some seasons ago.

“What a remarkable memory for faces you have, haven’t you?”

“No—for rings.”—Exchange.

Received hunting gloves from the Luther people. Please accept thanks for them; they are O. K. in fit and quality.

M. L. Lavey, North Manchester, Ind.

“A new automobile, Mr. Rush! You must be busy dodging your creditors.”

“My creditors! Ha! they keep dodging me now.”—Exchange.

THREE SPLENDID BOOKS

500 PAGES. 1,000 ILLUSTRATIONS

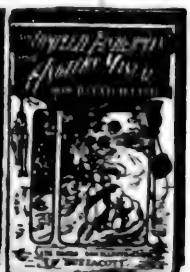
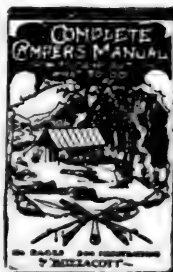

A REMARKABLE OFFER—“A SURPRISE”

167 pages each. The three books, in all 500 pages, now ready. “A Complete Sportsman’s Library.” Send 10c. in coin or stamps for either book, or 30c. for the three. Address, “BUZZACOTT,” Racine Junction, Wis.

The VIKING FOLDING CANVAS BOAT



HAS NO EQUAL FOR
LIGHTNESS
AND STRENGTH

STRONG AND STEADY
ON THE WATER

A PERFECT BOAT FOR
DUCK HUNTING
AND FOR FISHING

One of the many testimonials we have received

The 12-foot Viking received. I put it together in a few minutes and must confess that I was surprised to find the boat so much better in its material, design and workmanship than I had expected. For three years I have been looking for a suitable folding sportsman’s boat. Yours is the only one I have found that fills the bill. The solid wood bottom, the round, graceful, strong gunwales and the plan of taking up the deck with rawhide straps, supplies a defect I found in other boats. I took it with me on my vacation trip into the wilds of Nova Scotia where it was greatly admired. It enabled me to fish in lakes where no boat had ever been used. It is a gem on the water. I had it out on Lake Keejun Koo Jic, N. S., in a big blow, with two ladies in it. It rode the waves like a duck and did not ship a drop of water. I am pleased and anticipate some pleasant trips.

WRITE FOR OUR BOOKLET

GLASCOCK BROS. MANUFACTURING CO.

Yours
(Write for the name of user of this boat.)

Box 90, Muncie, Indiana

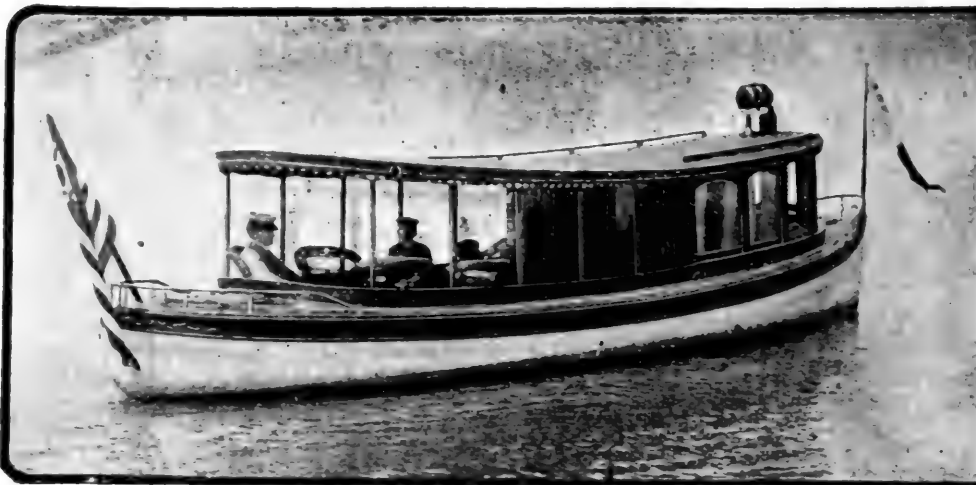

We've Made Good Boats and Machinery for Many Years.
THE KIND THE PUBLIC WANT
 You will see

TRUSCOTT BOATS

used exclusively at the World's Fair because investigation convinced the most exacting officials of their superiority. Look the matter up for yourself.

Automobile Boats and Engines
 Everything from a canoe to the 100 foot cruiser.

Our quarterly publication "The Launch," is full of matter interesting to boat owners and prospective. It's free for the asking. Catalog mailed, for postage, 10c.

Truscott Boat Mfg. Co
 ST. JOSEPH, MICH., U.S.A.



ACME FOLDING BOAT CO., MIAMISBURG, O.

U. S. Government who prefer our boats. Received medal and award at Chicago World's Fair. If you investigate we will get your order.

Send for catalogue of our full line of Folding Canvas Boats and Canoes, which have been adopted by Governments of United States, Canada and England. Just filled an order for

U. S. Government who prefer our boats. Received medal and award at Chicago World's Fair. If you investigate we will get your order. Mention RECREATION.

Acme Folding Boat Company, Miamisburg, O.



The "Perfect" Fishing & Hunting Motor Boat.

Length, 17' t. Beam, 4ft. Weight 350 lbs. Speed 6 to 7 miles. Price \$125
 The above equipped with The "Valveless" Gasoline Marine Motor, the most simple Motor on the market. Small weight. Large power. Perfect control. Price Motor Complete \$75.

F. W. SHERMAN, 16-18 Exchange Street, Buffalo, N. Y.
 Write for catalog. Agents Wanted

THE HILDEBRANDT SPINNER



For Fly Fishermen, A spinner which spins, and also catches fish. Strictly hand made and of the best material. No swivel required. Made with all kinds of Feather and

Buck-tail flies. For sale by dealers. Sent on receipt of 25c
J. J. HILDEBRANDT, Logansport, Ind.

THE LATEST, SAFEST AND BEST CANVAS BOAT

Is what we offer you. A Boat built on modern lines that will prove a pleasure to own and use. Selected materials used throughout, and it comes to you **guaranteed** the best. A handy and safe boat for fishing and shooting. Send 4 cents in stamps for catalogue and reliable testimony.

Mention RECREATION.

LIFE SAVING FOLDING CANVAS BOAT CO.
 757 Portage St., Kalamazoo, Mich.

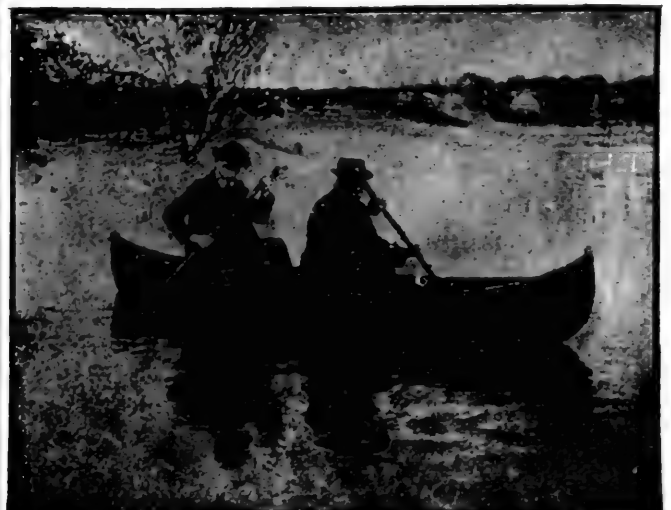
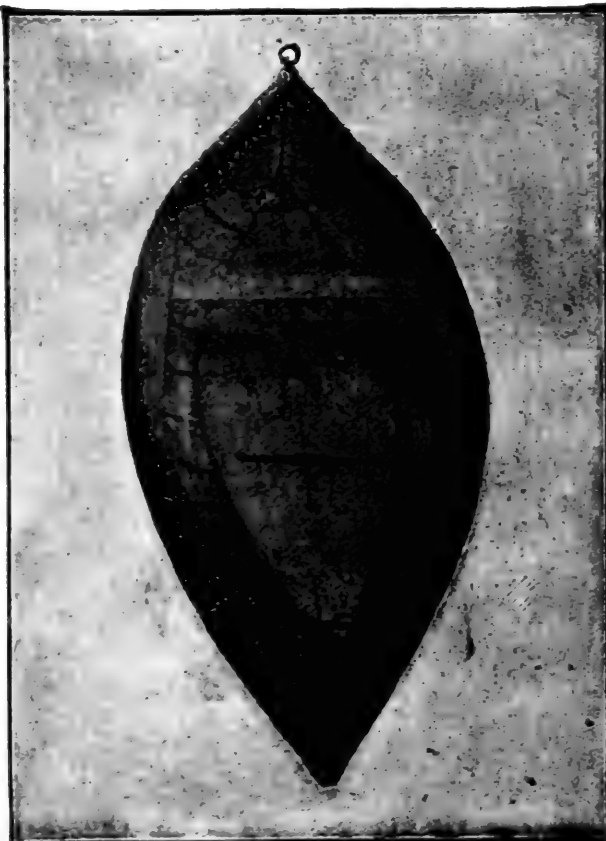

Latest patent and improved Canvas Folding Boat on the market. Puncture proof; Tempered steel frame. No bolts to remove. Folds most compact of any boat made.

Fine Fishing Tackle Free

The Famous Shakespeare Reels and Baits that Catch Fish, Free to any Enthusiastic Angler who Sends Name and Address.

I want every enthusiastic fisherman, whether amateur, beginner or professional to have a personal knowledge of the fine points of the Shakespeare Reels and the marvelous catching qualities of the Shakespeare Baits—and to do this I propose to send to every man or woman who fishes for the real sport there is in it, one of my



Who will
catch
the
\$100.00
Prize Bass
this
year?

reels and baits for free trial on their next fishing trip. Write to-day. Send your name and address and the name and address of the leading sporting goods dealer of your city to Wm. Shakespeare, Jr., 379 Shakespeare Bldg., Kalamazoo, Mich. The Shakespeare Reel is especially designed for accurate and long-distance casting, and it is without doubt the best reel in the world, and you will say so when you see it. The metal used in the manufacture of the Shakespeare Reel is hard-drawn brass and the finest English Stubbs steel—the best obtainable. Painstaking care is used to secure perfect accuracy in every detail. In beauty of design, and simplicity of construction it is unequalled. Its easy, silent running suggests perpetual motion and it is fitted with the most perfect drag and click ever invented. Words will not describe its beauty, its usefulness and its many advantages over all other reels. My reels and baits are for sale by all first-class dealers and I want you to see them and try them for yourself and if you will write me personally I will be glad to arrange it so you can have them for a free trial on your next fishing trip. The Shakespeare Baits are really marvelous. With them the fisherman is sure of a good catch, no matter where the fish are, in the lake or stream. If they are in deep water, Shakespeare makes the bait that attracts them. If they are in shallow water, Shakespeare makes the bait that catches them. If they are hidden in the lily pads or moss, Shakespeare makes the bait that makes them strike. And Shakespeare offers \$100 in prizes for the photograph and authentic dimensions of the biggest large or small mouth bass caught this year. Write to-day for fine illustrated catalogue and his little booklet, "The Art of Bait Casting." They are free to every angler. Write to-day and send your name and address.

RUSHTON CANOES



Paddle Your Own Canoe

Why not? Don't spend your money next summer in hiring canoes, but get one for yourself so that you and your friends may enjoy it every minute of the time. For pleasure there is nothing to equal it; for health and exercise nothing surpasses it.

I have been making all kinds of pleasure boats for 30 years. I know how to make the best that can be furnished for the money—and I do.

Send for my catalogue and select your canoe before it is too late in the season. My models are all popular, and one of them will certainly meet your ideas as to style and price.

My complete catalogue of pleasure boats, canoes and fittings sent free

J. H. RUSHTON, 817 Water St., Canton, N. Y.

Small Profits—Quick Sales

TROUT FLIES

for trial—send us



- | | | |
|-----|---|-----------------|
| 15c | for an assorted sample doz.
Regular price, 24 cents. | Quality A Flies |
| 30c | for an assorted sample doz.
Regular price, 60 cents. | Quality B Flies |
| 60c | for an assorted sample doz.
Regular price, 84 cents. | Quality C Flies |
| 60c | for an assorted dozen
Regular price 84 cents. | Bass Flies |

SPLIT BAMBOO RODS

Fly Rods 10 feet, 6 ounces **57 cents** Bait Rods 9 feet, 8 ounces

With cork grip and extra tip, in wood form

THE H. H. KIFFE CO.
523 Broadway, New York City

Catalogs of any of above goods free on application.
Mention RECREATION.

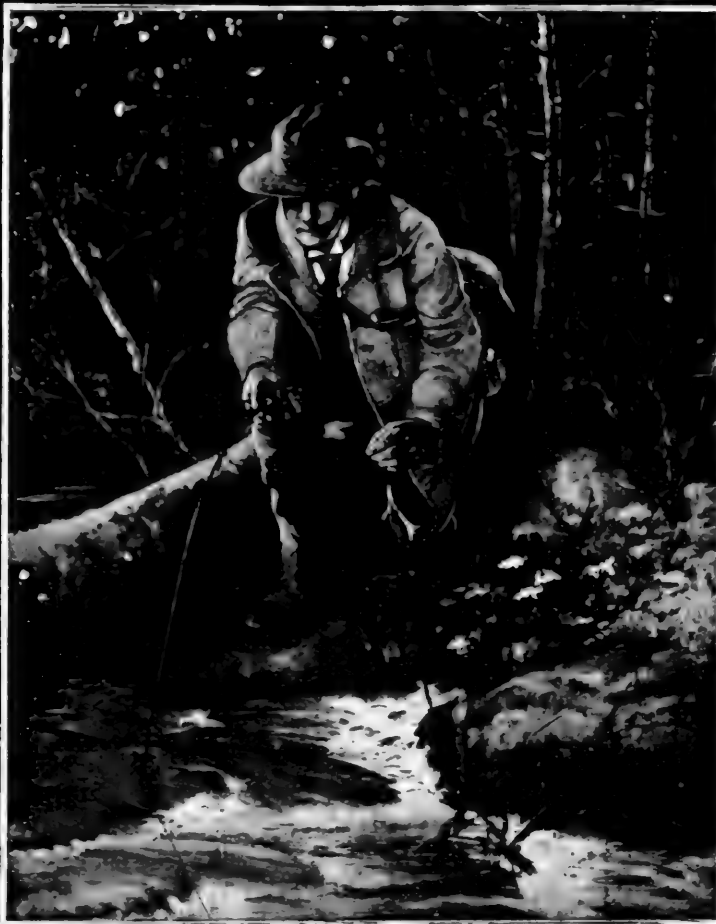

Start the trout season right, which means start with the

“BRISTOL.”

Use a “Bristol” Steel Fishing Rod on your first trip to the trout stream, and you will want to use it for all trips—always. The faintest nibble is instantly felt by the fisherman using a “Bristol,” and the delicate spring of the “Bristol” hooks the trout before he discovers that the bait has “a string to it.”

Prices reduced.

Ask your dealer about it.

Ask US for Catalog D.

The Horton Mfg. Co.,
Bristol, Conn., U. S. A.

ANGLERS, LOOK HERE!

8 pieces complete graduated open ring guides, reel seat and rod tip. Self-adjusting, nicked, spring steel. You can trim a cane pole ready for reel in 30 seconds. Of your dealer or by mail, 75c a set. \$7.20 dozen sets.

NOVELCRAFT MFG. CO.

Spring and Superior Sts. Cleveland, O.

For Sale:—Farm of 100 acres, watered, wooded and pleasantly situated; large house, good buildings, near railroad depot, post office and school; 9 miles from Narragansett Pier. Price, \$2,200. Easy terms. 1 or 2 high-grade guns taken in part payment. Address, Clarence Gardiner, Slocums, R. I.

AN IMPORTANT OFFER

For 2 Yearly Subscriptions to RECREATION I will send you

A RIFLE WICK PLUG

Made by HEMM & WOODWARD, Sidney, Ohio, 30 caliber up to 50 caliber.

OR

A SHOT GUN WICK PLUG

20 gauge up to 10 gauge

For 3 Yearly Subscriptions to RECREATION A Pair of Shot Gun Wick Plugs

20 to 10 gauge.

Sample copies for use in canvassing furnished on application.

Address RECREATION, 23 W. 24th St., N. Y. City

Detachable Even Spoolers & Hook-Shields

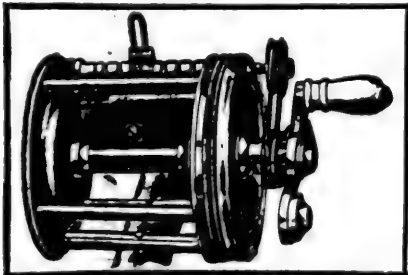

Bearing Reels fitted with even Spooler, also New Rubber Hook-Shield.

We exchange goods with Dealers any time to keep them in line with requirements in their locality.

A. W. BISHOP & SON, PATENTEES AND MANUFACTURERS
RACINE, WIS., U. S. A.

are the real thing. A boon to anglers. For proof ask any of the 7,000 users. In every case, as far as we know, they have given perfect satisfaction. In future buy only reels fitted with spooler or reels spooler will fit, preventing regrets later on. Our free catalogue (B) gives names of reels spooler will fit, price and description of Spoolers, Hook-Shields, Gun-Cleaners, Fish-Scalers, Ball-Bearing, Jeweled and Steel-Pivot-

Marble's Automatic Gaff

is as certain as death and taxes. You merely reach out, gently touch the fish and the gaff automatically and instantly closes upon him with a grip which HOLDS. This means the saving of the big ones which have got away year after year. A knurled projection on each side of hinge enables the gaff to be opened with the foot.

No. 1, For Fish from 1 to 20 lbs., \$1.50

No. 2, " " 10 to 60 lbs., 2.00

Nickled 50c extra, handles 30 in. long.
Buy of your dealer, or direct, *prepaid*.



No. 2 Gaff Closed

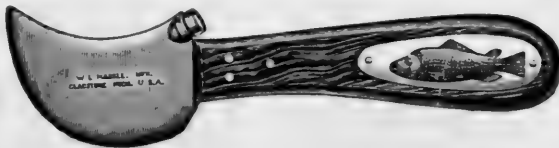

Send for catalog of other necessities for Sportsmen. It is free.



Showing No. 1 Gaff Open.

Marble's Handy Fish Knives

are made of tool steel hardened and tempered. Rosewood handle inlaid with German silver.

Prices, 85c and \$1.00, prepaid.

Marble Safety Axe Co., Dept. A., Gladstone, Mich.

RELIANCE MFG. CO.

CITY ISLAND, NEW YORK CITY

Gas and Gasoline Engines

Adapted to

Hoisting }
Pumping } Machinery
Portable }

Especially Designed for High-Speed Power Boats

Superior in Workmanship, Material
and Design

GOING into CAMP?

If so, you will need

A TENT

You can get one big enough for 4 men and their camp outfit, by sending me

8 Yearly Subscriptions to RECREATION

at \$1 each. You can get another tent big enough for 6 men by sending me

10 YEARLY SUBSCRIPTIONS

at \$1 each.

Why pay out money for a tent when you can make your friends pay for it?

Sail in and fit yourself for your summer vacation.

This is a great opportunity, and will hold good for only a few weeks.

Sample copies of RECREATION for use in canvassing furnished on application.

A CANINE ASSISTANT DEPUTY.

A young fellow named Gibson, living at Redfern, Neb., was in the habit of making trips to Gothenburg, always taking a trunk with him. Gossip had it that he was killing chickens. One day last spring, Dr. Farrell, one of our deputy wardens, seized the trunk and found 80 birds therein. After a long legal fight Gibson compromised with the authorities by paying \$100 and costs.

A few days ago the same deputy captured nearly 100 birds killed by Gibson. The latter has so far avoided arrest. When he is rounded up I will let you know the result.

Gibson is a crack shot, has a fine dog and hunts on horseback. It is said he sometimes kills as many as 4 dozen birds in a day. As they bring \$13 a dozen, he can pay a few fines and still be ahead of the game. If he gets the full dose on this last charge it may discourage him, as he can be fined \$5 and costs for each bird.

Dr. Farrell is the best game warden in Nebraska and has made more captures than all the others put together. He has a bird dog that enjoys a hunt in a baggage-room or freight house as much as he does in a field. When this wise dog points a trunk, box, barrel or tub his master uses a hatchet at once and always finds game.

W. F. Zumbrunn, Callaway, Neb.

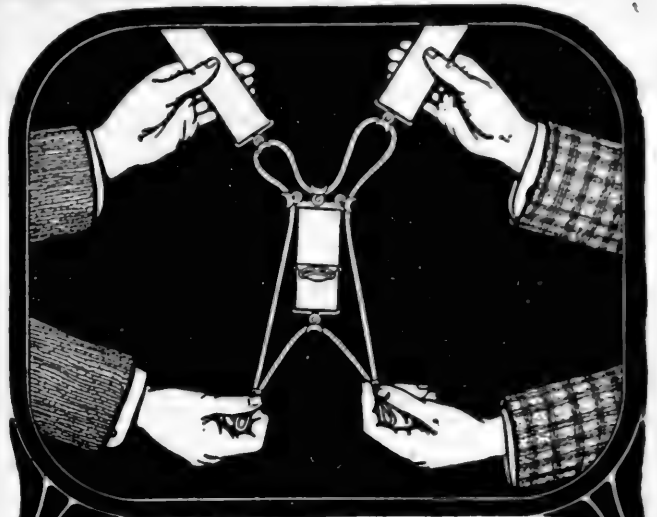

Give Ease—Take Strain
PRESIDENT
Suspenders

conform instantly to every bend of the body. Metal trimmings, cannot rust. No leather to soil the shirt. Satisfaction, a new pair, or your money back.

For summer comfort, ask for the **Light-weight President**. Same principle—same guarantee. 50c and \$1.00 any store, or mailed.

THE C. A. EDGARTON MFG. CO.,
Box 219, Shirley, Mass.

Webber's Hand-Knit Jackets

(Look for Webber's Name on Collar Band)



Webber's Hand-Knit Jacket, No. 4.

"A New One," made of zephyr yarn, very soft and woolly, medium heavy weight, very elastic. The jacket for spring and early summer. This jacket is not made for shooting particularly, but for all outdoor purposes. Order one and if not satisfied return it and get your money back.

Price each, \$6 50



Webber's Hand-Knit Hunting Jacket.

Medium heavy weight, each - - - - \$4.00

Webber's Hand-Knit Alaska Jacket.

Made with strap across throat, lined pockets and extra heavy, each - - - - \$5.00

If your dealer does not handle them send me the price and I will send you a jacket, express prepaid, and if not satisfactory, return the jacket and I will return your money.

GEO. F. WEBBER

MANUFACTURER.
Station A

DETROIT, MICH.



NEW JERSEY MILITARY ACADEMY
 Freehold, N. J. \$400 per year
 For Catalogue, address the Principals
 Col. C. J. WRIGHT, A. M., WALTER HEWETSON, A. B.

THE TOURIST ROUTE

TO
 New Orleans, Texas, Mexico
 and California.

THE NORFOLK & WESTERN RY.

OFFERS THE CHOICE OF THE
 New York & New Orleans Short Line
 OR THE

Famous Shenandoah Valley Route

Excursion tickets now on sale at greatly reduced rates
 permitting stop-overs at Washington, Luray Caverns,
 Natural Bridge, Chattanooga, Lookout Mountain, Bir-
 mingham, New Orleans and other interesting points.

Address.

W. B. BEVILL, G. P. A. L. J. ELLIS, E. P. A.
 Roanoke, Va. 398 Broadway, N.Y.
 C. P. GAITHER, N. E. A.
 112 Summer Street, Boston, Mass. 51x



Increase Your Income.
 Learn profitable poultry raising. Our success in teach-
 ing it has been phenomenal. Seven distinct courses
 by the personal correspondence method. The faculty
 are practical poultrymen and experienced teachers.
 All students who have studied with us have made
 money. This fascinating business, still in its infancy,
 offers tremendous opportunities for all who begin
 NOW. Write to-day for illustrated booklet fully
 describing our various courses of instruction.
 COLUMBIA SCHOOL OF POULTRY CULTURE, Box 610, Waterville, N.Y.

For Sale: 12 gauge Parker D. H. spe-
 cial, Lyman sights and Silver's pad. Cost
 \$86; also case cost \$7; will take \$50 for
 both. B. L. Sater, Yarmouth, Iowa.

WANT A REEL?

You can get one for nothing.
 Or at least for a few hours' work.

Send me

15 Yearly Subscriptions
 to
RECREATION

and I will send you

A TALBOT REEL

Listed at \$20

Made by W. H. Talbot, Nevada, Mo

This is one of the finest pieces of fishing
 tackle ever made. It is built like a gold
 watch. Equal to any Kentucky reel you
 ever saw.

In Tournaments, Always a Victor
 Among the Angler's Treasures, Always the Chief

I have but a few of these reels in stock
 and this offer will be withdrawn as soon as
 the present supply is exhausted.

Sample copies of RECREATION for use in canvassing
 furnished on application.

Squab Book Free



Squabs are raised in 1 month, bring *big*
prices. Eager market. Astonishing
 profits. Easy for women and invalids.
 Use your spare time profitably. Small
 space and capital. Here is *something*
worth looking into. Facts given in our
 FREE BOOK, "How to make money
 with Squabs" PLYMOUTH ROCK
 SQUAB CO., 11 Friend St., Boston, Mass.

For Sale: Double shot gun and Smith
 & Wesson revolver in fine condition;
 also new Washburn guitar. E. Atwell,
 Mountain Dale, N. Y.

Date, _____ 190

G. O. SHIELDS,

Editor and Manager of RECREATION, 23 West 24th St. New York.
 Herewith find \$1.00 for which please send me RECREATION one year
 beginning with _____ number,

Name, _____

Remit by P. O. or Express Money Order, or New York Draft.

DETACH THIS, FILL OUT, AND SEND IN

Taxidermists' Glass Eyes for Oologists' and Entomologists' Supplies

Materials

Send 5c. in stamps for catalogue

**FRED. KAEMPFER, 88 STATE ST.
Chicago, Ill.**

Taxidermy work done in all its branches

Mention RECREATION



INDIAN CURIOS

WHOLESALE & RETAIL
CURIO DEALERS'
SUPPLY DEPOT.

Bead Work, Baskets, Elk Teeth, Mexican
Goods, Beads, Fossils, Minerals, Arrow-
Heads, Pottery, Alaska Ivories, Shells,
Agates, Photos, Great Stock, Big Cata. 5c.,
stamps. Mention RECREATION. If a dealer
say so.

L. W. STILWELL,

DEADWOOD SO. DAKOTA



CLOSING OUT

The Best Collection in existence of the Mammals and
Birds of Minnesota.

Consisting of Mounted Mammals, Heads, Antlers,
Skins, Rugs, Mounted Birds, Skins, Eggs, Fresh Skins,
Relics, Curiosities, etc. *Send Stamp.*

ERNEST L. BROWN

The Minnesota Taxidermist. Warren, Minnesota.

FOR SALE

LIVE jack rabbits, prairie dogs, squirrels, deer,
mandarin, wood and other wild ducks, geese,
swan, and other game birds and animals.

CHAS. PAYNE, Wichita, Kansas.

FINE MOUNTED GAME HEADS,
BIRDS, ETC., for sale at unheard-of prices.
Send 10 cents for photos.

JOHN CLAYTON, Taxidermist, Lincoln, Maine

To Amateur Photographers

Here is a Chance to Get a
FINE CAMERA EASILY

A 4x5 Tourist Hawk-eye film camera list-
ing at \$8, for 5 yearly subscriptions to REC-
REATION. A No. 3 folding Weno Hawk-eye
film camera, listed at \$15, for 10 yearly
subscriptions to RECREATION.

These are both neat, compact, well made
and handsomely finished cameras, capable
of doing high-class work.

*Sample copies for use in canvas-
sings furnished on request.*

Address RECREATION

23 West 24th Street, New York City

THEY FIGHT FOR SPRATT'S



TERRIER BISCUITS

These biscuits are specially prepared for Terriers of
all breeds and other medium-sized dogs. They form a
well balanced ration, containing the necessary pro-
portions of meat, bone, cereals and vegetables in
judicious combination.

Eaten with avidity, they are easily digested, make
bone and muscle, and not fat, thus insuring the true
terrier qualities of energy and action.

Price, in Cartons		\$0.25
25-lb. bags	-	1.90
50-lb. bags	-	3.50
100-lb. bags	-	7.00

Write for our catalogue "Dog Culture," with practical
chapters on the feeding, kenneling and management of dogs,
also a chapter on cats, **FREE.**

We also manufacture a specially prepared food for dogs,
puppies, rabbits, cats, poultry, game, pigeons, fish, birds, etc.

Spratt's Patent (America) Limited

450 Market St. 1324 Valencia St. 714 S. 4th St.
Newark, N. J. San Francisco, Cal. St. Louis, Mo.

Free: To anyone sending through me
\$1 for 1 yearly subscription to **Recrea-
tion**, I will give a sportsman's pocket
medicine case. For 2 subscriptions, a
physician's pocket medicine case. Walter
Lusson, Ardmore, Pa.

Wanted: Names and addresses of
traveling men in sporting goods lines.
Address C. L. Weinstock, Perkinsville,
Vt.

SPORTSMAN Be your own Taxidermist

LEARN TO MOUNT ALL KINDS OF
BIRDS, ANIMALS, HEADS, ETC.



We teach Taxidermy perfectly
by mail. Easily and quickly
learned. **STANDARD METH-
ODS,** Expert instructors, reason-
able price. Our **SCHOOL
FOR SPORTSMEN, BY
SPORTSMEN,** is endorsed by
all leading taxidermists and
sporting magazines. The spring
shooting season is at hand. You
will secure some beautiful spec-
imens. They deserve a place in
your home, den, or office. Are

you interested? Our new illustrated catalog is just
ready and **IT'S FREE TO EVERY READER OF
RECREATION.** WRITE FOR ONE TODAY.

The Northwestern School of Taxidermy, Inc.
411A BEE BUILDING OMAHA, NEB.

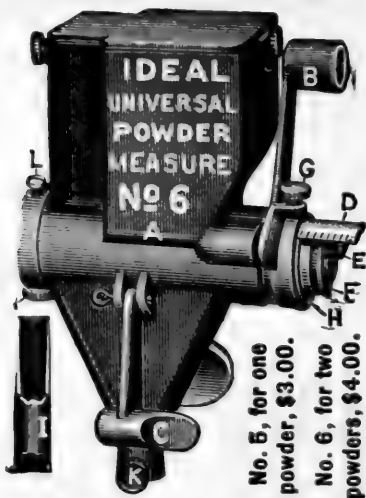

No. 5, for one powder, \$3.00.
No. 6, for two powders, \$4.00.

POWDER! POWDER!

All kinds of powder for **Rifles, Pistols** and **Shot Guns, measured accurately** from 1 to 145 grains. 4 different measures in 1. The latest and best tool. Ask your dealer for it.

Every shooter should have 1. Send 3 stamps for **Ideal Hand Book**, 146 pages of information to shooters.

IDEAL MFG. CO., 120 St., New Haven, Conn., U. S. A.

The **PHIL B. BEREART CO.**, of San Francisco, Cal., Agents for Pacific Coast

When you write kindly mention RECREATION

KOENIG'S SHELL EXTRACTOR.



Every shooter should have one—carry it in a vest pocket. Fits any gauge shell. Koenig's Gun Catalogue, Free.

10 Cts. Postpaid.
E. G. KOENIG, NEW JERSEY'S LARGEST GUN HOUSE
SOUTH BROAD ST., NEWARK, N. J.

BIG MONEY In Mail-Order Business

People are buying more by mail than ever before: one mail order house does a business of a million dollars monthly; another receives 2,000 letters daily, nearly all containing money; mail order trading is unquestionably the business method of the future. The field is large, the possibilities unlimited. Let us send you our plan for starting beginners; it covers every point. Enclose stamp.

CENTRAL SUPPLY CO., Kansas City, Mo.

PATENTS

promptly obtained **OR NO FEE.** Trade-Marks, Caveats, Copyrights and Labels registered. **TWENTY YEARS' PRACTICE.** Highest references. Send model, sketch or photo. for free report on patentability. All business confidential. **HAND-BOOK FREE.** Explains everything. Tells How to Obtain and Sell Patents, What Inventions Will Pay, How to Get a Partner, explains best mechanical movements, and contains 300 other subjects of importance to inventors. Address,

H. B. WILLSON & CO. Patent Attorneys
786 F Street, N. W., WASHINGTON, D. C.

ANTI-RUST WICK PLUGS FOR FIRE ARMS

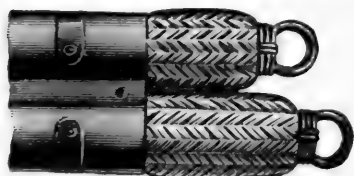

Tubular wick plugs, oiled, fit inside of gun barrels snug, full length, so cannot pit or rust.

RIFLE or SHOT GUN, per plug, 50c., postpaid
SHOTGUNS, per pair - \$1.00, postpaid

Give gauge and length of barrel.

WRITE FOR CIRCULARS

HEMM @ WOODWARD

Sidney, Ohio

Automobilist—Say, where can I get some repairs made? I've met with an accident.

Farmer—What d'ye want— a machine shop or a hospital?—Motor.

Please accept my thanks for the Shakespeare revolution bait you sent me so promptly. It is a first class article, well made and was easily earned.

L. A. Hubacek, Milwaukee, Wis.

No Rifle complete unless mounted with one of our

IMPROVED TELESCOPIC OUTFITS

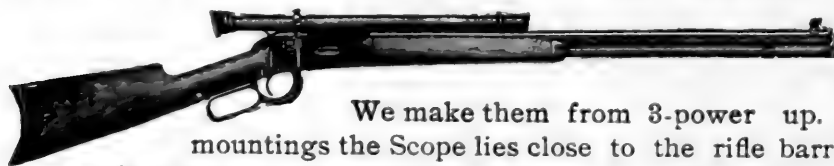

We make them from 3-power up. With our side mountings the Scope lies close to the rifle barrel and the open sights are left entirely clear and unobscured.

SEND FOR OUR CATALOGUE
Mention RECREATION.

THE MALCOLM RIFLE TELESCOPE MFG. CO.

F. T. CORNISH, Mgr.

Established 1857

SYRACUSE, N. Y., U. S. A.



"Collan-Oil"

preserves leather and renders shoes and harness positively

WATERPROOF

Used by the U. S. the Army and Navy and National Guard.

Send 25c. for trial can.

AGENTS WANTED

Write for terms and circulars

J. R. BUCKELEW

Dept. A. 111 Chambers St., N. Y.

Practical Common Sense
in 6 Sizes.

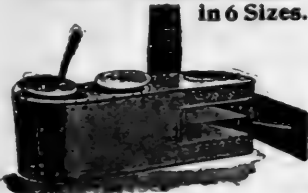

CAMP STOVE

Either with or without oven. The lightest, strongest, most compact, practical stove made. Cast combination sheet steel top, smooth outside, heavy lining in fire

box and around oven, holds its shape, telescopic pipe carried inside the stove. Burns larger wood and keeps fire longer than any other. Used by over 9,000 campers and only one stove returned.

For catalogue giving full particulars, mention RECREATION and address.

D. W. CREE, Manufacturer, Griggsville, Ill.

Wanted: Names and addresses of travelling men in sporting goods lines. Address C. L. Weinstock, Perkinsville, Vt.

How is your Muscle?

Would you like to build it up?

How are your Lungs?

Would you like to expand them?

How is your Circulation?

Would you like to improve that?

If so, send me **6 yearly subscriptions** to RECREATION, accompanied by a money order for \$6, and I will send you a new

PROFESSIONAL PUNCHING BAG

made by H. D. CRIPPEN, No. 52 Broadway, New York and listed at \$6.95.

There is a frame with the bag that you can attach to a door casing, a window casing or a wall, or a board fence, or anywhere else you may see fit to put it, and you will thus have a small gymnasium of your own. The Crippen bag is one of the liveliest ever devised, and if you will put 20 minutes a day on it, for a month, you will find a wonderful improvement in your muscle and your health.

Sample copies of RECREATION, for use in canvassing, will be mailed free.

NEWHOUSE STEEL TRAPS

Made since 1848 by ONEIDA COMMUNITY

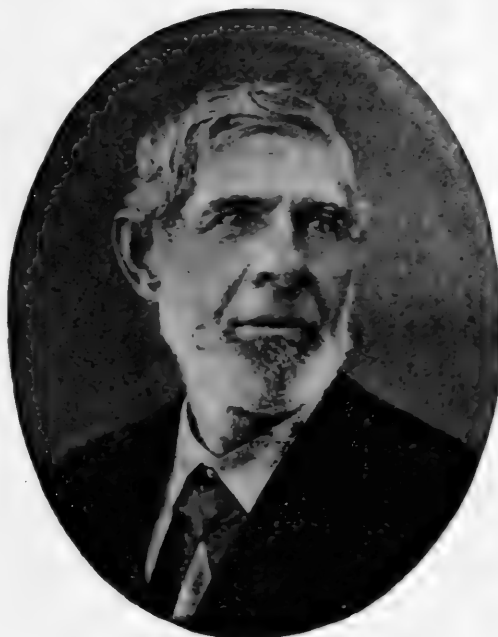

S. NEWHOUSE
(The Old Trapper and Trapmaker)

Fifty years ago this famous old Trapmaker of the Oneida Community would not let a trap leave his hand till he KNEW that it would hold any animal that got into its jaws. Even greater pains are taken now than then in selecting the finest steel and rigidly testing every part.

This is why all experienced Trappers insist on having the

"NEWHOUSE"

"I have seen an Indian trade his pony for one dozen Newhouse Traps."—*Popular Magazine Writer.*

Eleven Sizes for Catching Every Fur Bearing Animal

Every Trap Guaranteed

Illustrated Catalogue Mailed

Send twenty-five cents for "The Trapper's Guide," by S. Newhouse, telling all about fur bearing animals and how to trap them, together with interesting narratives and practical directions for life in the woods.

ONEIDA COMMUNITY
ONEIDA NEW YORK

SLEEP

IS TIRED NATURE'S
SWEET RESTORER

After a hard day's tramp, you must have

A Good Night's Rest

in order to fit you for the next day's work. Better to sleep on a good bed without your dinner, than sip at a banquet and then sleep on the cold, hard, wet ground. You can get

A Recreation Camp Mattress

of rubber, with valve for inflating, made by the Pneumatic Mattress Co., and listed at \$18.

For 10 Yearly Subscriptions to
RECREATION

Send for Sample Copies

Address RECREATION, 23 West 24th Street, New York

Robin Hood Smokeless Powder

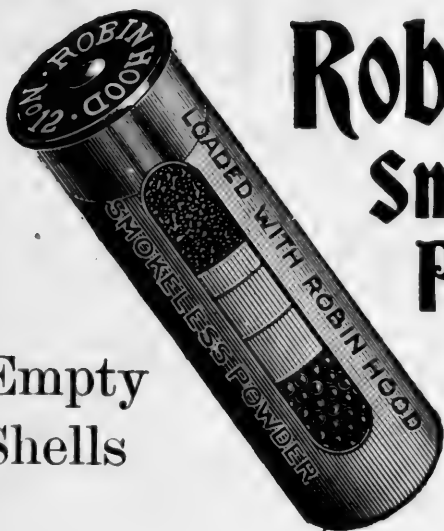

Empty
Shells

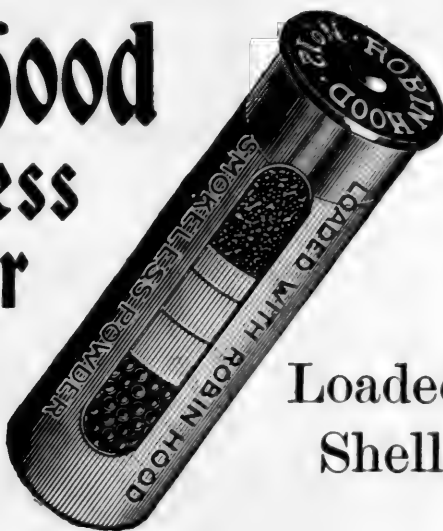

Loaded
Shells

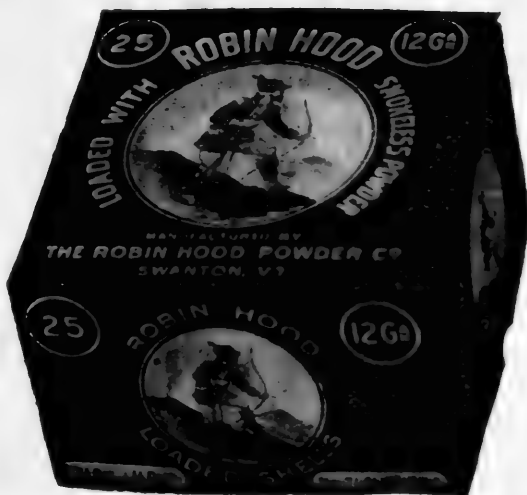

**Up-to-date
Dealers
Sell them.**

**Price
Pattern
Penetration**



Manufactured
by

The Robin Hood Powder Co.

Swanton,

Vt.



HERE IS ANOTHER!

If you will send me

30 Yearly Subscriptions

to

RECREATION

I will send you

**A No. 10 Trieder = Binocular
Field Glass**

Listed at \$38.

Every well-informed man knows the great power of this modern prismatic field glass. It is indispensable to every hunter, and is one of the latest and best on the market.

I have but a few of these instruments on hand and the offer will be withdrawn as soon as the supply is exhausted. Therefore, if you want one

START IMMEDIATELY

Sample copies of RECREATION for use in canvassing furnished
on application

1904 Art Catalog



CONTAINS

Photographs and Descriptions Sixteen Guns

ABOVE CUTS SHOW

No. 1 Special, Sold last year \$25, this year \$21

No. A Grade, Sold last year \$21, this year \$19

WRITE FOR SPECIAL PRICES ON ALL GRADES GUNS
MENTION RECREATION

Ithaca Gun Company
ITHACA, NEW YORK

DO YOU WANT A FOLDING CANVAS BOAT?

If So, Send Me

35 Yearly Subscriptions to RECREATION

AND I WILL SEND YOU

A 14 ft. King Folding Canvas Boat

LISTED AT \$48

capable of carrying 2 men and an ordinary camp outfit. There are thousands of these boats in use, and nearly every man who is using one of them praises it on every occasion.

Sample copies of RECREATION for use in canvassing will be furnished on application.

Address 23 West 24th St., New York

ONE OF THE 9 "SYRACUSE"

Built for Business.

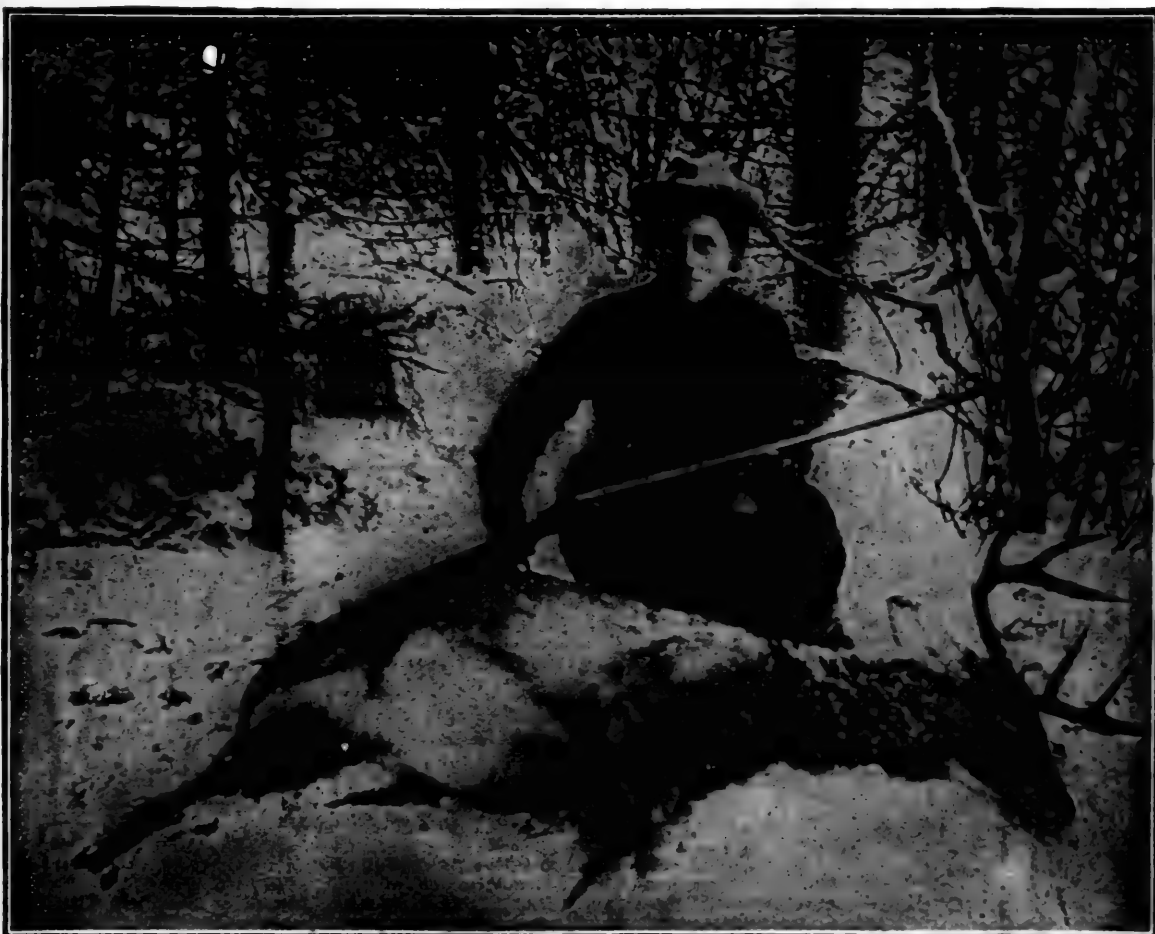

COPYRIGHTED 1903

SYRACUSE ARMS CO.

This picture shows the result of a

**SINGLE SHOT from a SYRACUSE
16 GAUGE**

THREES OF THIS KIND ARE HARD TO BEAT

Write for a
Syracuse
CAT.

**SYRACUSE
ARMS CO.**

SYRACUSE, N. Y.

Mention RECREATION.

GUN BARGAIN

We have purchased 46 high-grade

Hollenbeck Hammerless Guns

Which retailed at \$80. net \$100. net \$125. net

Will sell at \$38. \$45. \$50.

Send for special list with specifications.

SCHOVERLING, DALY & GALES

302-304 Broadway, New York

Mention RECREATION

THE BAKER

THE GUN
THAT'S SAFE



SO DURABLE TOO
IT LASTS A
LIFETIME

If you want to be right up in the front rank of style and efficiency shoot one of our **Special Paragons** with *Whitworth or Krupp fluid steel barrels*. We have other patterns also that would please you. Our "Quarterly" tells about them and other matters that would interest you. We will send it you *free a year* if you want it.

BAKER GUN & FORGING CO., 42 Liberty Street, Batavia, N. Y.



**This is the New
9 F. Grade**

NEW LEFEVER

It is a plain gun, and sells at a popular price, but has all our latest improvements.

D. M. Lefever, Sons & Co.
Not connected with
Lefever Arms Company,
Syracuse, N. Y.

Send for
1904
Catalogue
and
Discounts

Mention
RECREATION

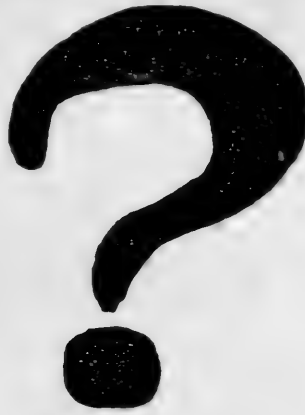

Discriminating sportsmen are enthusiastic over the many novel features of the **SAVAGE 22 CALIBER REPEATER**. It is hammerless, shoots the short, long and long rifle cartridges all in the same arm, and its accuracy alone has placed it in a class by itself.

WRITE TO-DAY FOR CATALOGUE G—FREE

Our 1904 Calendar sent on receipt of ten cents in stamps

SAVAGE ARMS COMPANY

UTICA, NEW YORK, UNITED STATES OF AMERICA
BAKER & HAMILTON, San Francisco and Sacramento, Cal., PACIFIC COAST AGENTS

I am in receipt of the Korona camera you sent me as a premium for subscriptions. It is a beauty and does fine work. I can recommend the Koronas to any one looking for a good camera.

A. C. Gorham, East Pembroke, N. Y.

Says a rural editor: "Owing to the overcrowded condition of our columns a number of births and deaths are unavoidably postponed this week."—The Pathfinder.

Free:—I will give anybody sending me articles named below:

Ideal Shell Closer, 10-12-16 gauge, sells for 50c.

Ideal Shell Loader, 10-12-16 gauge, sells for 50c.

Perfection Gun Oiler, can not spill when not in use, worth 50c.

Web Shot Shell Belt, 10-12-16 gauge, sells for 75c.

Henry B. Floyd, 723 Eighth St., N. W. Washington, D. C.

THE PARKER AUTOMATIC EJECTOR

The Latest attachment to
The "OLD
RELIABLE"



New York Salesroom, Send for Catalogue. PARKER BROS.,
33 WARREN ST. Mention RECREATION. Meriden, Conn.

Going Fishing?

Well fixed for rods? If not,
send me 5 yearly subscriptions to

RECREATION

and get a Bristol Steel Rod—
any one listing at \$6.00 or less.

Everybody knows what a Bristol
Steel Rod is. It is equal in
strength, durability, suppleness,
and all the other good qualities to a
split bamboo rod costing \$20.

The Sick One Decides



Not the druggist.
Not I.

He sends not one penny.
Simply asks for my book.
And if helped pays the cost
of the medicine—gladly.

Will you write me to-day?
Let me tell you the name
of a druggist near by, so
that you may take
six bottles of

Dr. Shoop's Restorative

On a month's trial. If it succeeds, the cost to you is \$5.50. If it fails, the druggist will bill the cost to me.

Think What This Means

You may be discouraged, almost without hope. Even then I take the risk—not you.

I furnish the treatment, give you my best advice, answer all your letters. If I succeed the cost is only \$5.50. If I fail, my efforts and my medicine are free.

Can't you see that I must know how to cure? Else this offer would be impossible.

Come to my office. Consult my records. Learn that 39 out of each 40 who take my Restorative pay for the medicine. They need not if it failed.

Read letters like this:

"I was suffering with nervous debility, biliousness and a run down constitution. Your Restorative restored my health and I now feel as I did when I was in my teens, going to school, although I am now past my 66th birthday. I shall always keep a bottle of Dr. Shoop's Restorative in the house, as it has been worth many times the cost to me." S. A. Jones, Anvil, Okla.

And this:

"Dr. Shoop's Restorative has done me more good than all the medicine I have ever taken. I am using it for Catarrh of the head and nervous debility. My wife is also using the Restorative for indigestion with good results. I am talking my friends into using your remedy." J. J. McDonald, Palos, Ala.

And this:

"I had not eaten breakfast in the morning for over 20 years until I took your Restorative. It appears that it is not only a Kidney medicine, but equally good for the stomach. I am recommending it to my fellow Railroad Men, for I feel that Dr. Shoop's Restorative can cure any Kidney disease that is curable. I will gladly write to any of your patients and tell them how it restored me to health." M. J. Mannx, 46 Thomas St., Buffalo, N. Y.

Isn't this evidence enough?

Tell Your Friend Who Is Sick

Tell him of my discovery. How I alone treat the inside nerves. Not the nerves you feel with, the nerves you know about, but the inside nerves that operate the vital organs—that give them strength and power and health.

Other physicians, other specialists even, are still treating the organs themselves—mere repairing. That is why no other physician—not even your home physician—makes terms to you like mine.

Tell your friend to-day, for my way may be his only way to get well. And every hour that you wait adds an hour to his suffering. The medicine can not harm him. If it fails he, at least, is as well as he was. And not one penny poorer. There's no excuse—no reason for delaying.

The book I send him is clear. Almost any sick one who reads it will know that he can get well. Your friend may never see the book unless you write me.

Ask for it to-day.

Were you the sick one, he would have written before this. Be as good a friend to him as he would be to you. Write me to-day.

Simply state which
book you want and ad-
dress Dr. Shoop.
Box 6224, Racine, Wis.

Book 1 on Dyspepsia
Book 2 on the Heart
Book 3 on the Kidneys
Book 4 for Women
Book 5 for Men (sealed)
Book 6 on Rheumatism

Mild cases, not chronic, are often cured with one or two bottles. At druggists.

H. & R. SINGLE SHOT GUN

Automatic and Non-Ejecting

The cheapest absolutely safe gun, with improvements found heretofore only in the highest priced.

PERFECT IN MODEL
AND CONSTRUCTION

SIMPLEST "TAKE
DOWN" GUN MADE

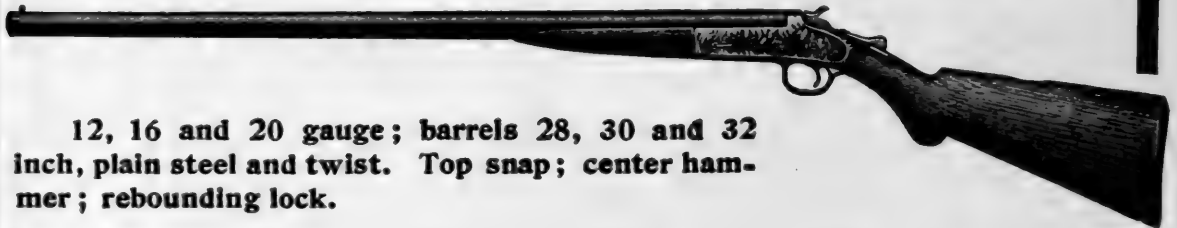

12, 16 and 20 gauge; barrels 28, 30 and 32 inch, plain steel and twist. Top snap; center hammer; rebounding lock.

Your dealer can supply, or we will sell to you direct. Write for Catalog.

HARRINGTON & RICHARDSON ARMS CO.

Dept. R, WORCESTER, MASS.

Makers of H. & R. Revolvers

For Sale: Fine Moose Head; 12 points on one side and 14 on the other; 49 inches between the widest points; web 12 inches wide; bell 12 inches long. Price \$250. Photo mailed upon request. G. A. Henry, Jr., Hibbing, Minn.

I received the Mullins steel boat. It is a dandy and the easiest rowing boat on our river. Had 9 people in it one day, which is pretty good for a 15-foot boat. It did not row any harder than with only 3 in.

E. K. Airey, Binghamton, N. Y.

BRADLEY'S ANTI-RUST ROPES!

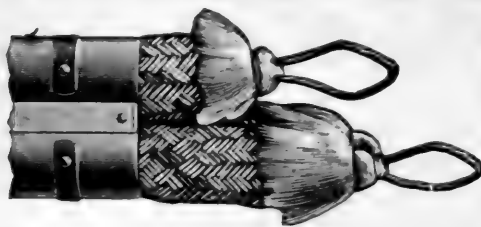

For SHOT GUNS, RIFLES and REVOLVERS. They cannot rust or pit if these ropes are used. No more worrying to keep your fire arms in perfect condition. Sent postpaid, \$1 per set for Shot Guns; 50c. for Rifles; 25c. for Revolvers. Give gauge and length of barrel. Send for circular giving full particulars.

BRADLEY'S SHOT GUN SIGHT

Makes wing shooting easy and certain. Scores greatly increased at trap and in field. Instantly attachable and detachable. Price, post-paid, 50 cents. Send for circular.

Address C. L. BRADLEY, CLARKSVILLE, TENNESSEE.
Mention RECREATION.

The Problem of Success

at the trap is largely a problem of equipment. It is generally conceded and once you have tried a

DAVENPORT

HAMMERLESS No. 2 GUN

with Full Length Matted Top Rib or our Heavy Hammer Trap Gun, you will agree that better results are obtained with a single than with a double gun. **The Single is positively the Trap Gun of the Future**, so get in line and procure the best for the purpose. Catalogue Free.

Mention RECREATION.

The W. H. DAVENPORT FIRE ARMS CO., Norwich, Conn.

High-Speed Hammer
Long
STAMPS

25¢ 25¢ 25¢ 25¢ 25¢ 25¢ 25¢ 25¢ 25¢ 25¢
 (Descriptive list with illustrations mailed on receipt of 2 stamps)

25¢ 25¢ 25¢ 25¢ 25¢ 25¢ 25¢ 25¢ 25¢ 25¢
 25¢ 25¢ 25¢ 25¢ 25¢ 25¢ 25¢ 25¢ 25¢ 25¢

25¢ 25¢ 25¢ 25¢ 25¢ 25¢ 25¢ 25¢ 25¢ 25¢
Head & Sons 101 Washington Street **Boston**
 Send 2 stamps for list

DELICIOUS
CHOCOLATE
THE BEST MADE



DELICIOUS
CHOCOLATE
THE BEST MADE

DELICIOUS
CHOCOLATE
THE BEST MADE

Have been established over 50 YEARS. By our
 since the year 1850. We take old ins.
 in your hands free of expense.

Head & Sons
 101 Washington Street
 Boston, Mass.

YOU
NO

MAR 13 1904

THE BROWN TOWHILE;

with full page drawing

an interesting story of bird life, by DR. R. W. F.

THE BROWN TOWHILE OF THE LAKE OF AMERICAN SPORTSMEN

...not the pure ice of the "Ordnance" more stirring
...the ice are stirring, all nature awakening and
...to make up for their long winter's fast.

...could cast your line in pleasant places, don't
...the new fishing season opens in British Col-
...Brunswick on April 1st,
...British.

...of the following:—

- ...NEW YORK.
- ...BOSTON.
- ...CHICAGO.

...MONTREAL

RECREATION

Copyright, December, 1903, by G. O. Shields

A Monthly Magazine Devoted to Everything the Name Implies

\$1.00 A YEAR.
10 CENTS A COPY.

G. O. SHIELDS (COQUINA),
Editor and Manager.

23 WEST 24TH STREET,
NEW YORK

CONTENTS OF THIS NUMBER

	PAGE.
The Mustelle Family at Home.....	FRONTISPIECE
Some Adventures of Minnie Mustelle, the Mink. Illustrated.....	H. B. BROWN 255
The Praxis of Salmon Angling.....	E. J. MYERS 260
Red Breasted Merganser. Illustrated.....	ALLAN BROOKS 270
Wild Animals and Birds in the Northwest. Illustrated.....	G. O. SHIELDS 271
The Brown Towhee. Illustrated.....	DR. B. W. EVERMANN 277
Whip-Poor-Will. Poem.....	F. A. JOHNSON 279
Joe Bedore of St. Clair Flats. Poem.....	H. W. BRADLEY 281
In the Coast Range.....	D. E. WYNKOOP 282
How to Build a Mackinac Boat. Illustrated.....	FRED A. HUNT 285
The Troubles of 2 Tenderfeet.....	KLATTOWA 287
From the Game Fields..... 289	Forestry..... 312
Fish and Fishing..... 293	Pure and Impure Foods..... 314
Guns and Ammunition..... 297	Publisher's Notes..... 316
Natural History..... 303	Editor's Corner..... 318
The League of American Sportsmen..... 307	Amateur Photography..... 324

Entered as Second-Class Matter at New York Post Office, Oct. 17, 1894.

BE NEAT!

USE

WASHBURNE'S PATENT IMPROVED FASTENERS

AS APPLIED TO

Cuff Holders

THE LITTLE FASTENER WITH A BULL DOG GRIP.

Instantly attached. Never lets go by accident.

CUFF HOLDERS 20¢ BACHELOR BUTTONS 10¢
SCARF HOLDER 10¢ DRAWER SUPPORTERS 10¢
KEY CHAIN & RING 25¢

At all dealers, or sent prepaid on receipt of price.
Illustrated Catalogue on request.

AMERICAN RING CO.
DEPT. 44 WATERBURY, CONN.

Sore Throat

Hoarseness, Quinsy, Tonsillitis
Laryngitis and other throat
troubles quickly relieved
and promptly cured
by the use of

Hydrozone

This scientific germicide is used and endorsed by leading physicians everywhere. It is *absolutely harmless*, yet a most powerful healing agent.

By killing the germs that cause these diseases, without injury to the tissue, Hydrozone cures the patient. Sold by leading druggists. If not at yours, will send bottle, prepaid, on receipt of 25 cents.

Prof. Charles Marchand

F-59 Prince Street, NEW YORK
FREE.—Valuable Booklet on How to Treat Diseases.

April Suggestions

THIS is the time of the year to look over the rods, polish up the guns, test the used lines, replenish the fly books and generally examine the various implements of the outdoor life. It is also a splendid time to plan outings for the coming season, to study guide books, maps and perhaps correspond with native experts on the spot. In all these things we can help you. Our establishment is a

Permanent Sportsmen's Show

Here you will find everything that the sportsman needs, from the big canoe to the tiny trout fly. We have guide books, maps, names of famous native and Indian guides, and, perhaps better than all, we have abundant personal acquaintance with the life in the woods and with scores of interesting places and trips. Our experience and information is at your service.

If you can not call at our shop send us your name, with 10 cents, and we will forward our Catalogue "R," which fairly smells of the forest and is full of the joys of the trail and camp fire.

ABERCROMBIE & FITCH

MANUFACTURERS OF COMPLETE

**Outfits for Explorers,
Campers and Prospectors**

314-316 BROADWAY, NEW YORK, U. S. A.

Marble's Automatic Gaff



No. 2 Gaff Closed

is as certain as death and taxes. You merely reach out, gently touch the fish and the gaff automatically and instantly closes upon him with a grip which HOLDS. This means the saving of the big ones which have got away year after year. A knurled projection on each side of hinge enables the gaff to be opened with the foot.

No. 1, For Fish from 1 to 20 lbs., \$1.50
 No. 2, " " 10 to 60 lbs., 2.00

Nickled 50c extra, handles 30 in. long.
 Buy of your dealer, or direct, *prepaid*.



Showing No. 1 Gaff Open.

Marble's Handy Fish Knives



No. 2, 85c postpaid.

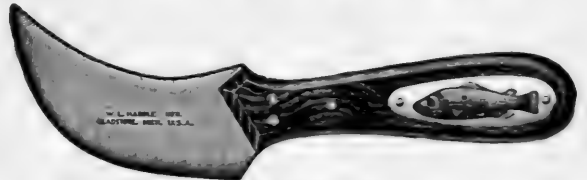

No. 3, \$1.00 postpaid.

These have a thumb rest which enables you to put the pressure over your work when cutting off head and tail. Specially designed for cleaning and scaling. The blades are of tempered tool steel, handles of Rosewood inlaid with German silver. We give a sheath free with each knife.

WHEN YOU GO FISHING YOU WILL NEED A Waterproof Matchbox and Waterproof Compass



for it is sure to rain and you may slip off from a wet log into the water. Every sportsman knows the value of dry matches. They're always a comfort and sometimes they save lives.

Marble's Waterproof Matchbox is substantially made from brass, heavily nickel plated, and holds enough matches to keep a man in smokes and fires for several days. We guarantee it to be air and moisture proof. 50c postpaid.

Marble's Waterproof Compass attaches to coat or vest. Sometimes people get lost because they do not consult their compass often enough. This one is always in plain sight. You don't have to hunt in every pocket before you find it and then try to settle it while the mosquitoes are eating you up.



With revolving dial,agate bearing	\$1.50	} Post paid
" stationary " " "	1.25	
" " " brass "	1.00	

For sale by dealers everywhere or from us, prepaid. Send for catalog of "Life preservers for the Woods and Plains."

Marble Safety Axe Co., Dept. A., Gladstone, Mich.

Racine Boat Mfg. Co.

Muskegon, Michigan

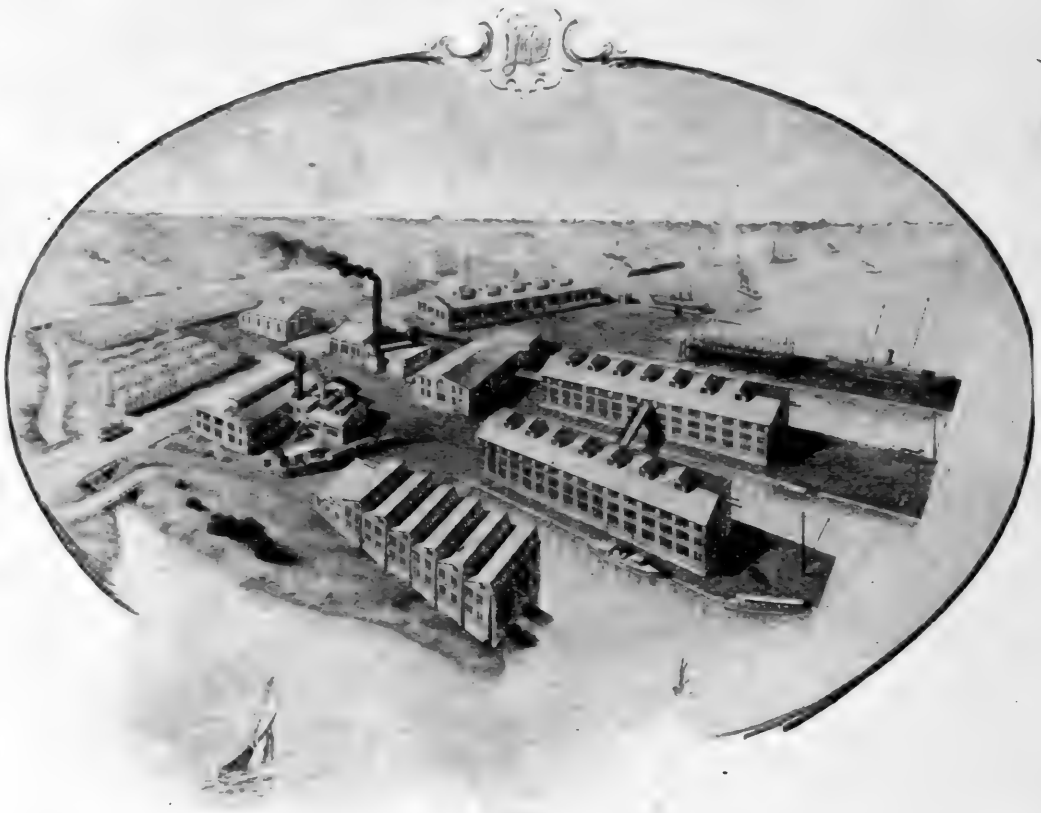

The above illustration shows our new plant at Muskegon, Mich., which we have been busy completing since our fire last May, which had destroyed our entire plant at Racine, and not being able to secure sufficient water frontage at that place, we were forced to look elsewhere for a suitable location. We have a magnificent location here right on the lake, with three docks 800 feet long, and $10\frac{1}{2}$ acres of water front property. We have built an up-to-date plant and have equipped the same with the latest machinery and tools, and are now prepared to offer our customers the very best results that can be obtained in the following:

Steam and Sail Yachts in Steel or Wood, Engines and Boilers, 20th Century Motors, Automobile Boats, Racing Machines, Turbine Propeller Motor Boats, Working Boats, Cabin Motor Boats, Launches and Tenders, Row Boats, Hunting Boats, Sail Boats and Canoes.

Our 64-page Catalog describing our 1904 product will be ready for distribution April 1st, and it will give the truth in detail about the best boats built. It is yours for the asking. Agencies in all the principal cities.

Address **Racine Boat Mfg. Co.** (Riverside)

Muskegon, Mich.

New York Office: 318 Broadway



THE OLD WAY

THE BOAT as pictured below in every detail—length 15½ feet, beam 4 feet, with ¾ h. p. Blomstrom gasoline engine,

\$100

*So simple a child can operate
with entire safety*

Catalogue D, including Marine Gasoline Engines of from ¼ to 80 horse-power at corresponding prices, free on request.

THE C. H. BLOMSTROM MOTOR CO.
1284-1294 River Street Detroit, Mich.

[From the Chicago Journal, May 7th, 1903]

At last an honest soul has put a 15½ foot launch with gasoline engine—4 foot beam—within the reach of the masses.

THE NEW WAY

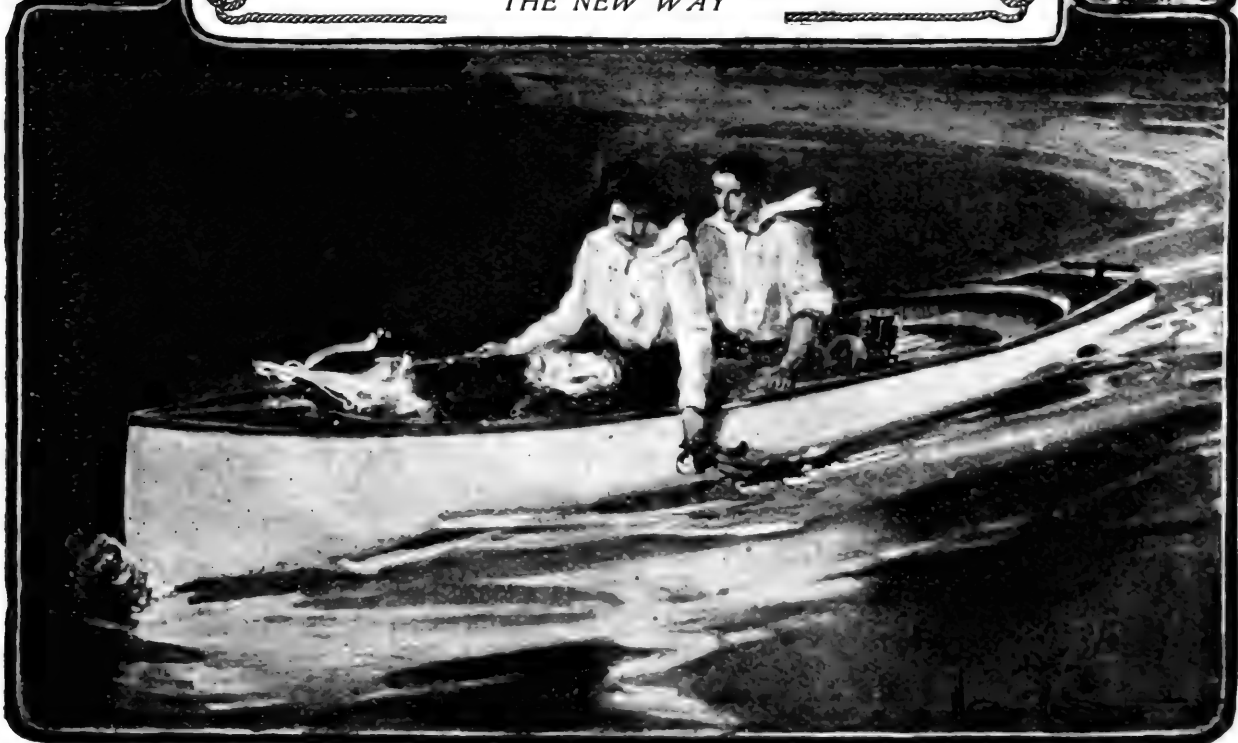

A CABIN CRUISER



Using Our New Design, the

"SPEEDWAY" GASOLENE MOTOR

We also build THE ONLY NAPHTHA
LAUNCH. Electric Launches, Alco
Vapor Launches, Steam and Sail Yachts

OUR SHOWROOMS CONTAIN 100 FINISHED LAUNCHES TO SELECT FROM



Send 10 cents in stamps for new catalogue of Small
Cabin Cruisers, Naphtha or Alco Vapor Launches



GAS ENGINE & POWER CO. & CHARLES L. SEABURY CO.
CONSOLIDATED

Largest Builders of Pleasure Craft in the World

MORRIS HEIGHTS, NEW YORK CITY

Down-Town Office, 11 Broadway

Chicago Office, 1409 Michigan Avenue



Model A,
With Detachable Tonneau,
\$850.00.

CADILLAC



Model B, Touring Car
\$900.00.
Without Tonneau, \$800.00.

Our Cars and Our Record—Do You Know Them?

The first Cadillac was put on the market early in 1903.

"Can't be sold profitably for the money," competitors said, and prophesied an early rise in price or decline in quality.

The end of the year saw the country full of satisfaction-giving Cadillacs, and our sales exceeded by those of only one manufacturer.

In the recent contest a stock Cadillac went up Eagle Rock Hill *on the high gear* in 3.19, winning first prize for vehicles of its class and defeating all machines under double its rated horse-power.

At all the big auto shows this season, where the most discriminating purchasers are found, the Cadillac exhibits have been centers of attraction to an extent that speaks volumes both for the reputation of the Cadillac and for the mechanical excellence of the machines exhibited. *More Cadillacs were sold during the New York show than any other make.*

Model B, embodies more novel and exclusive features of merit than can be found in any other automobile, no matter what the price.

Frame is of pressed steel; running gear and suspension system an absolutely unique and unrivaled combination of strength and flexibility that makes the car ride over the roughest roads as safely and smoothly as a Pullman coach. In points of speed, design, construction, luxury of appointments, ease of control and quietness of running, it is all that the name Cadillac stands for—greatest results; fewest complications. *All 1904 Cadillacs are equipped with clincher tires.*

Model A carries several improvements, otherwise it is the same safe, speedy, reliable machine as last year, and is sold at the same prices—\$750 as a runabout; \$850 complete with detachable tonneau.

Our handsome new booklet K explains and illustrates both models in detail, and gives address of agency nearest you where they may be seen and tried. Free on request.

CADILLAC AUTOMOBILE CO., Detroit, Mich.
Member Association of Licensed Automobile Manufacturers.



Pike's Peak from the Garden of the Gods.

Colorado—

That's the title of a handsome new book of seventy-two pages, beautifully printed, bound and illustrated; fifty-six pictures of Colorado's matchless mountains, valleys, streams, lakes and forests.

The book is written in a most delightful vein and gives pleasing glimpses of a mountain world whose colossal beauty never wearies or changes or grows old. A splendid map of Colorado is appended.

It is not a guide book but contains a few paragraphs about the best way to reach Colorado from everywhere east and southeast via Chicago or St. Louis (Louisiana Purchase Exposition) and the Burlington Route, with its splendidly equipped one-night-on-the-road fast express trains.



P. S. EUSTIS, Passenger Traffic Manager,
209 Adams Street, CHICAGO.

Enclosed is ten cents, for which send me a copy of the Burlington's 1904 Colorado Book.

Name _____

P Address _____



The culmination of progressive enterprise

CHAINLESS BICYCLES

Western Department
Chicago, Ill.

Two-Speed Gear, Coaster Brake

Eastern Department
Hartford, Conn.

Catalogues free at our 10,000 dealers' stores, or any one catalogue mailed on receipt of 2-cent stamp.

POPE MANUFACTURING COMPANY



DELAWARE WATER GAP

**Lackawanna
Railroad**

An ideal spring and summer resort in the Blue Ridge Mountains of Pennsylvania, with Stroudsburg and the beautiful Delaware Valley near by; 2½ hours from New York; golf, boating, bathing, fishing. A handsomely illustrated book of 128 pages, with full information about hotels and boarding houses, and a fascinating love story, "A Chance Courtship," will be sent for 10 cents in stamps.

Address, T. W. LEE, General Passenger Agent, Lackawanna Railroad, New York City.

California

SPECIAL TRAIN FOR YOU

The Santa Fe will run two personally-escorted special trains to Los Angeles via Grand Canyon, leaving Chicago April 27 and 28, account General Conference, M. E. Church. Stops made at Albuquerque and Laguna in New Mexico, the Grand Canyon of Arizona, also Redlands and Riverside in California.

You will travel on the cleanest railway in the West—oil-sprinkled tracks and oil-burning engines in Arizona and California.

\$50

ROUND-TRIP FROM CHICAGO

The rate is low—
why don't you go?

Also \$53 from Chicago to California one way, second-class, daily, March and April.
Write to-day for particulars.

Gen. Pass. Office
Atchison, Topeka & Santa Fe Ry.
CHICAGO



ALL THE WAY

"A great deal in a little space."
—The Press

"THE FOUR-TRACK SERIES"

This is the title of a series of books of travel and education issued by the Passenger Department of the

NEW YORK CENTRAL & HUDSON RIVER RAILROAD.

These small books are filled with information regarding the best modes of travel and the education that can best be obtained by travel.

They relate specifically to the great resorts of America—to trips to the islands of the sea and around the world

They also contain numerous illustrations and new and accurate maps of the country described.

A copy of the 52-page Illustrated Catalogue of the "Four-Track Series" will be sent free, upon receipt of a two-cent stamp by George H. Daniels, General Passenger Agent, New York Central & Hudson River Railroad, Grand Central Station, New York.

EVER BEEN TO MEXICO?

Have you ever thought what an easy trip it really is? And how inexpensive?

Modern methods are rapidly being adopted and in a few years much of its picturesqueness will be gone.

GO NOW and see it at its best. Don't forget the Camera. You will have no trouble in finding things to take. Your trouble will be in deciding what not to take.

CAN'T TAKE THE TIME?

Then go to Eureka Springs. Not like Mexico, but a charming spot for a rest. You'll need your camera there too.



Write for
particulars
of trip
"A"

HAL S. RAY, G.E.P.A., 401 B'way, N.Y.



**Cut Glass Claret Pitcher
"Lakeland"**

Sterling Silver Mounted
1 Quart - - - - each, \$12
3 Pints - - - - each. 18

HIGGINS & SEITER

**Fine
China**

**Rich Cut
Glass**

We illustrate our "*14 Less than
Elsewhere*" policy by pricing
this extra fine specimen of genuine

American Cut Class
(see illustration)

For thousands of other offerings equally
attractive send for Catalogue No. 14 "U"
having delicately tinted pictures of
choice china. Free to all interested
in purchasing.

**West 21st and West 22d Streets
Near Sixth Avenue NEW YORK CITY**

"Buy China and Glass Right"

SOMETHING ENTIRELY NEW

A

Hammock

That's Made Right

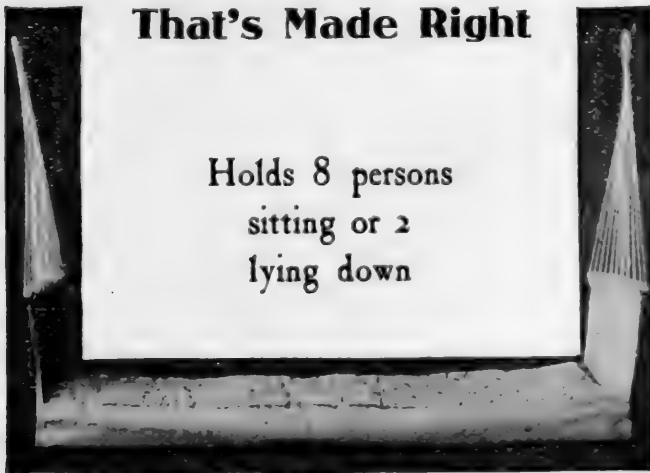

Holds 8 persons
sitting or 2
lying down

Solid
Comfort
and very
Handsome.
For
Inside
or
Outside.

Is made
for those
who want
something
fine.
Will
wear for
years.

Fine Cotton Filled Mattress and Handsome Cover

Queen Hammock Company

174 W. North St., Kalamazoo, Mich.

"FOR 36 YEARS A STANDARD PIANO."

THE WING PIANO

YOU NEED THIS BOOK IF YOU INTEND TO BUY A PIANO. A book—not a catalogue—that gives you all the information possessed by experts. It makes the selection of a piano easy. If read carefully, it will make you a judge of tone, action, workmanship and finish; will tell you how to know good from bad. It describes the materials used; gives pictures of all the different parts, and tells how they should be made and put together. It is the only book of its kind ever published. It contains 116 large pages and is named **The Book of Complete Information about Pianos**. We send it free to anyone wishing to buy a piano. Write for it.

SAVE FROM \$100 TO \$200 We make the WING PIANO and sell it ourselves. It goes direct from our factory to your home. We do not employ any agents or salesmen. When you buy the WING PIANO you pay the actual cost of construction and our small wholesale profit. This profit is small because we sell thousands of pianos yearly. Most retail stores sell no more than twelve to twenty pianos yearly, and must charge from \$100 to \$200 profit on each. They can't help it.

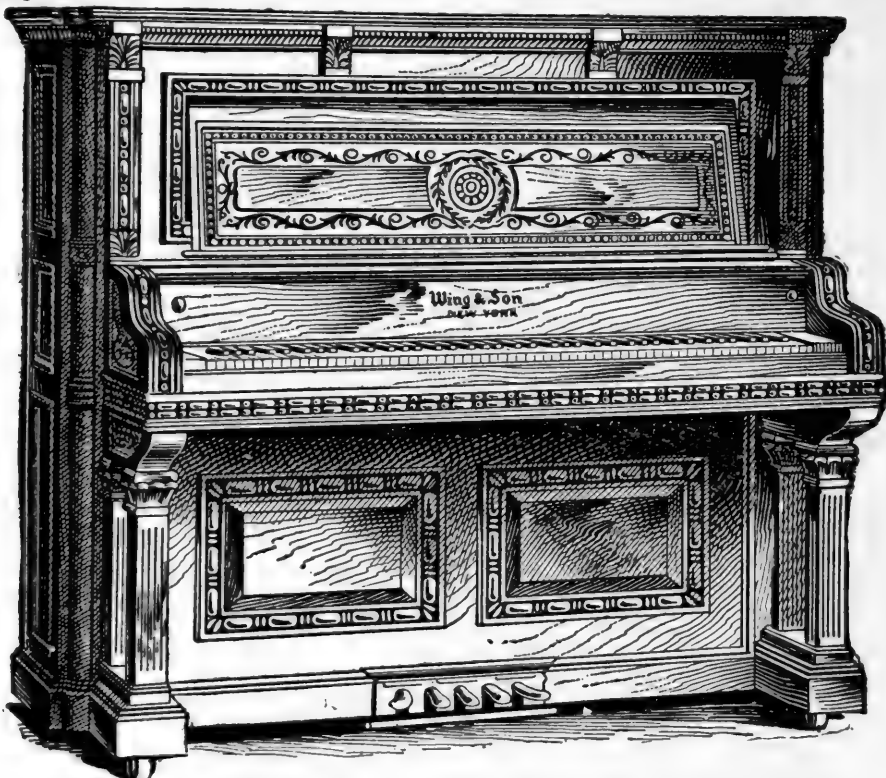

A Wing style—45 other styles to select from.

SENT ON TRIAL WE PAY FREIGHT. NO MONEY IN ADVANCE. We will send any WING PIANO to any part of the United States on trial. We pay freight in advance, and do not ask for any advance payment or deposit. If the piano is not satisfactory *after twenty days' trial in your home, we take it back entirely at our expense.* You pay us nothing unless you keep the piano. There is absolutely no risk or expense to you.

Old instruments taken in exchange. **EASY MONTHLY PAYMENTS.**

INSTRUMENTAL ATTACHMENT A special feature of the Wing Piano; it imitates perfectly the tones of the mandolin, guitar, harp, zither and banjo.

IN 36 YEARS, 33,000 PIANOS We refer to over 33,000 satisfied purchasers in every part of the United States. WING PIANOS are guaranteed for twelve years against any defect in tone, action, workmanship or material.

WING ORGANS Are just as carefully made as Wing Pianos. They have a sweet, powerful, lasting tone, easy action, very handsome appearance, need no tuning. Wing Organs are sold direct from the factory, sent on trial; are sold on easy monthly payments. For catalogue and prices write to

WING & SON, 350 to 356 West 13th St.,
NEW YORK.

1868 —36th Year—1904.



“Leading a Dog’s Life”

wouldn't be so bad if all dog owners were dog lovers. But, unfortunately, there are many people with hearts so small and minds so dull that they don't appreciate a dog's real worth. They neglect their dogs, treat them unkindly, and, if they fall sick, drive them away to cure themselves or die.

A sick dog ought to receive attention as well as a sick man. There are ways of curing dogs' diseases and saving dogs' lives, just as there are ways of treating and curing men.

The greatest remedy known for all the ailments that afflict the canine race is

Sergeant's Condition Pills

This great remedy combines all the elements that are necessary in the treatment of nine-tenths of dog diseases. It is a tonic, builds up strength, gives appetite, makes the dog bright, active and full of vigor. No other medicine is so valuable for keeping dogs in perfect health; no other medicine has such a remarkable record of cures.

Price, \$.50 and \$1.00, postpaid anywhere

Sergeant's Sure Shot

Canine worms kill many valuable dogs. Not only puppies, but grown dogs are afflicted, and often when a dog is suffering from this cause, his owner is at a loss to understand what the matter is. The more prominent symptoms of worms are nausea, colic, pains, restlessness, feverishness and abnormal appetite. Many varieties of worms infect dogs, but Sergeant's Sure Shot kills them all. It is safe, harmless and, used in conjunction with Sergeants Condition Pills, is all that a dog needs to make him well.

Price, \$.50, postpaid anywhere

Send 3 cents for postage and we will send you, free, our handsome Book on Dogs, and a Pedigree Blank.

Our remedies are on sale at leading drug stores and sporting goods dealers, or will be sent postpaid by us on receipt of price.

POLK MILLER DRUG CO. Sole Proprietors of Sergeant's Dog Remedies **RICHMOND, VA.**

TAKE YOUR CHOICE.

1 QUART \$1.00

4 QUARTS \$3.20

WE PAY EXPRESS CHARGES IN EITHER CASE.

We have one of the largest distilleries in the world. We are the largest bottlers of whiskey in the world. We have more whiskey in our eight Bonded Warehouses than any other distiller in the world. There is more **HAYNER WHISKEY** sold than any other brand in the world. We have been in business for over 37 years, serve regularly half-a-million satisfied customers and have a capital of \$500,000.00 paid in full, so you run no risk when you deal with us. Don't forget that **HAYNER WHISKEY** goes direct from our own distillery to you, with all its original strength, richness and flavor, thus assuring you of absolute purity and saving you the enormous profits of the dealers. Don't forget that a **HAYNER** quart is an honest quart of 32 ounces, 4 to the gallon. It takes 5 of the ordinary "quarts" to make a gallon. We give one-fourth more in every bottle, reducing our price just that much. You get both quality and quantity

HAYNER WHISKEY

Send us **\$1.00** for **ONE QUART** or **\$3.20** for **FOUR QUARTS** of **HAYNER SEVEN-YEAR-OLD RYE**, and we will pay the express charges. We ship in a plain, sealed package; no marks to even suggest contents. When the whiskey reaches your home, try it, sample it thoroughly. Then, if you don't find it all right, perfectly satisfactory in every way and better than you ever had before or can buy from anybody else at any price, ship it back to us at our expense and your money will be promptly refunded. We stand all the expense if you don't wish to keep the whiskey. **YOU** risk nothing. We ship one quart on your first or trial order only. All subsequent orders must be for at least 4 quarts at 80 cents a quart. The packing and express charges are almost as much on one quart as on four and even at \$1.00 for one quart we lose money, but we want you to try it. **WE PREFER TO HAVE YOU ORDER FOUR QUARTS FOR \$3.20 RIGHT NOW FOR THEN WE WILL MAKE A LITTLE PROFIT AND YOU WILL ALSO SAVE MONEY.** But take your choice. \$1.00 for 1 quart or \$3.20 for 4 quarts, express prepaid. Your money back if you're not satisfied.

Trial orders for Ariz., Cal., Col., Idaho, Mont., Nev., N. Mex., Ore., Utah, Wash., or Wyo. must be 1 Quart for \$1.25 by EXPRESS REPAID. Subsequent orders on the basis of 4 QUARTS for \$4.00 by EXPRESS PREPAID or 20 Quarts for \$16.00 by FREIGHT PREPAID.

Remit by Check, Bank Draft, Express or Money Order. It is unsafe to send currency unless you register your letter. Write our nearest office and do it NOW.

ESTABLISHED
1866.

THE HAYNER DISTILLING COMPANY,

DISTILLERY
TROY, OHIO.

DAYTON, OHIO.

ST. LOUIS, MO.,

ST. PAUL, MINN.,

ATLANTA, GA.,







THE MUSTELLE FAMILY AT HOME.

RECREATION.

Volume XX.

APRIL, 1904

Number 4.

G. O. SHIELDS (COQUINA), Editor and Manager

SOME ADVENTURES OF MINNIE MUSTELLE, THE MINK.

H. B. BROWN.

Now, my dear children, you have reached an age when you will soon have to go forth into the world to earn your own livings, and I naturally wish to prepare you for the struggle for existence in every way I can. Most of your knowledge must be gained by personal experience, a costly school, sometimes bitter, yet often most pleasant; but it may be that from some of the events which have befallen me you will obtain ideas that in the future may be of benefit to you.

You must know that I, Minnie Mustelle, was once like you, my dears, a helpless, woolly youngster, weak and unsteady on my limbs, and as unsophisticated as you now are. As I became older and stronger my mother took me out each night, together with my brothers and sisters, and taught me secrets of the chase, as I shall soon teach you. Finally I became so skilled and had such confidence in my own ability that I severed family ties and roamed into strange territory, continually searching for a more favorable hunting ground and never finding one that was entirely satisfactory.

During one of these pilgrimages I first saw your father, whom you have never seen, but whose name I bear. He was born and raised North of the Canada line, as you might gather from the manner in which he spells his family name, and it was up in that direction he and I first met. I never shall forget how handsome, lithe and strong he was when I first saw him. I had caught glimpses before of others of my kind, yet he was a revelation to me

of the perfect development of the race, and I felt assured he was the most magnificent individual in all minkdom. Strive as I might, though the truth is I did not try, I could but fall heels over head in love with him.

You will understand when you are older that even although I at once admitted this state of affairs to myself, it is not seemly to show too soon how you bestow your affections, lest the recipient fail to appraise them at their true value and to esteem them as highly as he otherwise would. Therefore, I was coy and shy, yet his ardent advances and impetuous wooing none could long withstand, and we soon were happily wedded.

In time I learned that his disposition was far from perfect. When I warned him of your near arrival he expressed himself in such violent terms and made such dire threats that it seemed only prudent to seek this cosy nook and arrange to live the life of a grass widow until such time as you were able to shift for yourselves. To accomplish this I selected a night when the rain was falling swiftly enough to wash away all traces of my footsteps, deserted your father, came to this sheltered place and prepared the comfortable little home you have always known. The roof is a great boulder piled on others of its kind; and but a few feet from our low and narrow door flows Black brook, which, when you approach the opening, you can hear tumbling merrily over the rocks on its way to Dead river.

This is an exceptionally easy country

in which to pick up a living, and this point recommended itself to me strongly when I made my choice. The boggy shores of the pond which lies a little above our house and of which this brook is the outlet, are the haunts of numerous frogs; some little ponds still farther above, as well as the big river below, are the homes of untold musquash. Both ponds and brook teem with delicious trout, while there are numerous grouse and other things good to eat in the surrounding forest.

These fish on which you have been trying your new teeth during the last few days are called brook trout, the finest flavored and most delectable of any fish that swims. We will all go out together in the near future, and I will show you how to dive into a pool and catch them. How I obtained these and the other good things on which we have feasted of late, I will tell before my story is finished.

Men, whom, by the way, you should always avoid, as many of them kill from an unholy delight in killing, have often called us thieves and gluttons and have pointed the finger of scorn at us, being in their ignorance entirely misled as to the causes and reasons for what we do. To the charge of being thieves I have nothing to say, because all know that whatever we take is that to which we originally had a better title than any subsequent possessor has. The falsity of the other charge in the indictment is well illustrated by something your father tells of a lucky find he made on Kennebago stream, one summer, near where a party of men were camping. The campers had constructed in a neighboring brook a circular wall of stones, and within this cagelike affair had imprisoned about a score of their choicest trout to keep alive against the time of the party's going home. Your father happened along there one night, and, although one of the men came out to see what caused the splashing in the cage, and failed to understand it, Mr. Mus-

telle succeeded in capturing and killing every one of the imprisoned fish. He had carried away but a few when the men were astir, and he was obliged to desist. They were angry and said many hard things about your pa, even to calling him a "fish hog," the most odious term that can be applied to anyone who goes into the woods. Notice how they mistook him. He would have eaten every one of those fish, but that the men buried them where he could not find them, even after several diligent searches. His only object in killing all at once was that they might have time to age and reach their full flavor and delicacy. Men hang their game to ripen before they think of eating it, yet fail to comprehend that we most relish our fish when it has been given the same treatment.

I once overheard a fisherman on Spencer stream tell his companion that they would kill only such fish as could be eaten at the next meal, because the quicker a trout reached the frying pan after leaving the water the better it tasted. Poor man! He no doubt thought his statement true, but people have peculiar ideas about their food! Not only are fish much easier to eat and much more delicious when allowed to age after being killed, but musquash, grouse and nearly everything else improves by the same treatment.

A week ago to-day, while I was coming home from an unsuccessful night's forage, I had a peculiar experience. It explains how we have been able of late to fare so sumptuously. I had been the whole length of the brook on each bank, up one shore of the pond, had encircled one of the little upper ponds, and was searching back on the pond's other shore without success when I reached the spruce grove where the little log cabin is situated. As soon as I arrived opposite the camp my nose told me men had been there recently, and that was corroborated by something which was

pulled out on the shore near the water's edge. At first I was shy of investigating this contrivance, as the sky had begun to grow bright and in a short time the sun would rise, but I eventually mustered up courage to do so, thereby making an unusually lucky move. The contrivance was fashioned from thin strips of spruce wood and was covered with a material like that of a bag I once found sunk in the brook and containing a big chunk of deer meat. What caught my immediate attention was the particularly strong odor of trout which ascended from over the edges of this object. I could not withstand the temptation, so in I jumped, and found 8 handsome trout laid out on the spruce strips with which the thing was lined.

I at once seized the largest of the fish and lost no time in bringing it here. I continued making trips back and forth until I had the trout all stored safely in our house. In coming home I would make most of the journey by land, running along all fallen logs which lay in my course, but would always take to the water for part of the distance to throw off any marauder who might happen along while my tracks were still fresh. When returning to my find I would go about half way on land and then jump into the pond and swim the remainder of the distance. The water was perfectly still and by slipping in without any splash, which I could do even although the water was far below the edge of the bank, I was able to approach the place where the fish were, without a sound, and in so doing to assure myself that nothing threatened me harm.

After I had carried all the trout home it occurred to me that it was possible I had overlooked one in my haste, so back I went. I landed at the usual place and was standing on my hind legs with my front feet resting on the covered spruce shell preparatory to jumping when I received a

start which for a while set me trembling all over. Right in front of the camp and not 50 feet from me a movement caught my eye and I had a narrow escape from giving a jump and scream.

Before I go on let me tell you something which you must be sure always to remember, and that is: When you are anywhere outside of your home and see or hear anything you fail to understand or which seems to threaten harm, never make a noise and never make the smallest motion, not even so much as to wink, until you have become absolutely sure that your only safety is in flight. All who are forest residents understand this way of doing, and this trick has often been the salvation of its performer. It may be that nothing threatens you, or it may be that some enemy is near but has failed to see you. In the former case, as you know not from what you are running, you, of course, have no idea which way to go, and in the latter, to move will probably be to betray yourself. So remember, little ones, when startled to stand so still that you become as part of the landscape until you are satisfied that it is advisable and safe to move.

It was in this fashion I acted when I thought I saw a movement in front of the camp, but I finally concluded, as everything remained perfectly motionless in that direction, that I had been mistaken, although there was a 6 foot stump in front of the shanty which I had never before noticed. I had taken all the fish, but a search of the shore was rewarded by finding several heads. These also I carried home, concluding my labors with the sun more than an hour high.

The following day—or to be more exact, the following night, for it was dark when I began, although broad daylight before I finished—I visited the camp landing, and again found some trout and trout heads. This time, however, they were all on the

ground and had been fastened down by sticks driven through them into the earth. Some twigs had been left on the sticks, and only after tugging and pulling with might and main for some time at each fish or head was I able to get it loose and carry it off.

The stump which had frightened me the morning previous had disappeared, but right in front of a big rock had appeared a squat stump of most peculiar shape and appearance. During all my trips there, which were many, and extended over a week's time, this stump occasioned me considerable worry. It looked much like a man sitting there with his back to the rock, a man with big, round, glassy eyes, growing out of his head at the end of twin black tubes. However, as it never seemed to move, much less to make any attempt at approaching me, I endeavored to profit by my finds and to provide you with a store of good things, knowing from long experience how persistent one's appetite is and how futile it seems to be to satisfy it.

The next morning I again made the camp a visit and was pleasantly surprised to find a variety of eatables laid out, but as on the day before, each piece was pegged down and was removed only after a tussle. The supply included a quarter of musquash, a frog, a piece of bird meat, some whole trout and some heads. The musquash meat I took away first, and then the whole trout; after these the frog, then the heads, and last the bird. Every morning since there has been a variety of kinds of food there, and if ever a mink struck a veritable bonanza it would appear that I have.

The idea has come into my head

that possibly the camper there has been trying to find out my favorite food, and, if he has, he probably thinks it is musquash. If, however, he should offer me trout when I had eaten none for a long time and had a satiety of musquash, he might change his mind. I hope he will refrain from falling into the common error of making the actions of one member of a race characteristic of the whole, and in the matter of food I could tell him that at different seasons different things most appeal to us.

One morning some of the fish heads were in a little house near the water with one end open. After removing everything else I ventured in, taking the precaution to jump over what might be called the threshold. I recalled that one of my brothers had met an untimely end by investigating a similarly attractive nook and was careful to avoid the spot where there would be a trap if one had been set. Nevertheless in my struggles to release the heads from those exasperating pegs I entirely forgot my fears, and was only recalled to them by hearing a sharp click and feeling something give way beneath a hind foot. My heart went pit-a-pat, but no cruel jaws closed on my leg, and I concluded it was a false alarm. Could it have been that my friendly camper had set a trap with the springs tied to see if he could entice me into it? If he did I forgive him freely for the liberty, the more so because had my now worthless pelt been his object he would undoubtedly have obtained it.

Now, children, you are getting sleepy and I am too; so let us cuddle up together and save the rest of my adventures for another time.

Tommy—Say, paw, why do men get bald sooner than women?

Mr. Figg—Because they don't wear their hair so long.—Exchange.



AMATEUR PHOTO BY FLORENCE MOLIQUÉ.

I'M TRYING TO LOOK PLEASANT.

Winner of 8th Prize in RECREATION'S 8th Annual Photo Competition.
Made with a Korona Camera.

THE PRAXIS OF SALMON ANGLING.

E. J. MYERS.

There is no dry fly fishing in salmon angling.

Neither weigh, nor measure, nor dispose of your fish while the battle is waging.

There is no fishing up the stream in fly angling for salmon.

Delude not yourself with the thought that the killing fly of to-day will avail to-morrow!

If you cast for exercise, or on idle bent, keep away from the pool.

Suggestion for Fable No. 1:

Rising, hooking and playing for hours, and then without net or gaff landing a 30 pound salmon on a 6 ounce fly rod and trout cast!

My chief pleasures are:

To see the salmon surge for the fly and to feel the thrill that accompanies the first rush.

To see the fly drop from the salmon's mouth as the gaffsman lifts the fish from the water.

To detach the fly, first noting how it held the fish. No guide of mine performs this office!

Use only one fly on your leader.

Suggestions for Fable No. 2:

Special patterns of flies for certain months.

Exclusive patterns of flies for given rivers.

Success in salmon angling hangs on every whim, humor or vagary that imagination can attribute to the salmon, plus the x quantities of water and weather.

Verity it hath, and obtains in salmon angling, that the tyro's first attempt often putteth the expert to shame and causeth much chagrin till time brings humiliation to the boastful novice.

Where salmon usually lie is called the pool or cast.

At the first visit to a river an old inhabitant, or better still an old poach-

er, is more valuable than all your experience acquired on other rivers.

Luck may and does accomplish wondrous feats and plays all manner of pranks, but after all, the angler who knows the river best and throws the longest line well, will raise the most fish; and knowledge of the river and of the pool is beyond and above even skill and tackle!

There are 3 ultimates in salmon angling:

Knowledge of the river in general and an understanding of the mood, humor and condition of the pool in particular; skill in angling that accompanies the temperament of an angler according to Izaak Walton; possession of adequate angling tackle. Yet all these oft resolve into naught in the presence of the novice who possesses the killing fly.

Grey says:

"Then cometh the hour when the angler, wearied, hopeless, looks at the unsuccessful fly, wonders and ponders whether the fly was too big or too little; whether the color was right or wrong; whether some other fly would not do the turn; whether the cast was too light or too dark; and then wonders whether there are any salmon in the pool; nay, in the river!"

It is a most singular error that the farther stretch of the pool, hardest to cover with the cast, is taken to be the best water, while the salmon may be lying within a few yards.

Rise of water only will solve the problem when the salmon refuse to take the fly in falling or steady low water.

These be the characteristics of salmon pools:

Early, mid-season or late fishing.

High, normal, rising or low water.

Fish boiling (rising without showing themselves) at the foot of the pool

are supposed to be just entering the pool, and it is advisable to cast immediately, as they are likely to take the fly.

Salmon ascend the river at night, lying motionless by day; and, if unmolested, remain in the pool often for weeks until a rainfall raises the river, when they will take the fly; hence, suffer not the pool to be disquieted nor linger in inaction when the rain slackens!

It is said that salmon rest at head o' tide, where the salt water dams up the fresh, awaiting the taste that down-pouring rain raising the river gives, ere ascending to the pools; wherefore, the best fishing follows the rain and brings fresh run fish from the sea.

Carry all your knowledge to a strange river—it is but a closed book—and there begin anew, for only observation and close study will avail; verily, years are required to master the mysteries of the river whose pools baffle and perplex the newcomer from day to day, setting at naught the lessons of the day before.

Study the eddies and currents of the pool, its shades, shadows and depths, that you may determine the sweep and movement of the fly, its color, appearance and movement all vitally important; for often salmon only rise to the fly at a given point. Hence it is necessary to be able so to cast that the fly shall sweep in arc over that point.

You will learn that knowledge of even the shadows of cloud, mountain or tree may bring the successful solution of the mystery of the pool; that at given time and circumstance, the cast from a given point, given direction and of determined length will produce the only rise, though there be scores of salmon in the pool.

Use bright flies on dark days, and dark flies on bright days.

Query you the names and sizes of flies? Francis gives some names and Stewart a few more!

No limits have been set to the freak-

ish fancy of the factory girl tying the flies, or the conscience of the dealer outfitting you!

However, among many possessions, these I use, but recommend none:

Normal water. Jock Scott, Wilkinson, Silver Doctor, Grey Doctor, Durham Ranger, Silver Grey, Butcher, Smith, tied in red and yellow, Dandy, Cock Robin, Dusty Miller, White Winged Admiral, Sir Herbert, sizes 2 and 4.

Low water. Black Dose, Curtis, Dark Fairy, Black Ranger, Dark Admiral, Fiery Brown, sizes 6, 8 and 10.

Rising, moily or high water. Fancy free be your choice; rainbow-hued and huge barbed as a gaff, so they be sized 3-0, 5-0 or 7-0.

On deep, dark, rapid and rough waters employ a large, bright fly. On shallow, clear and bright waters, use a small, dark fly.

Save yourself much labor and vexation by thinking that a mere change of flies will tempt the fish to rise.

Size of the fly has more to do with success in salmon angling than all the combinations of feather and tinsel that fancy has devised. The proper size, once discovered, seldom varies on pool or river, except in freshets or rapidly falling water.

When beginning to angle, carefully note the pattern, color and size, until you discover the successful fly; for pattern, however skill and art may have lent their aid, is least in importance and likewise value. It yields to color, which gives away to size, the most difficult to ascertain, since success usually follows as soon as the proper size is determined.

The larger the collection of flies the angler has with him, the greater the chance that he will have the right fly, but far greater is the improbability of its being selected at the required moment, often entailing great loss of time, and likewise the salmon.

Never attach a fly to the cast until you have tried the loop of the fly by strongly pulling, for if that be defec-



SEGUIN RIVER, GEORGIAN BAY DISTRICT.

BY COURTESY OF GRAND TRUNK RAILWAY.

tive, it is worse than useless. Try the temper of the hook by inserting the point in a piece of soft wood and giving it a steady, moderate pull. If it be weak it will break at the neck.

Try your flies when you buy them; it saveth vexation of spirit and humility that abases itself. Hold the bend of the hook firmly in one hand and then see if you can move the head and wings; if they shift, the fly is not well tied, and thereon suffer not yourself to be persuaded.

There be single and double hooked flies. The former permit delicate casting and finer pitching; the latter are surer in holding and not so easily expelled by the salmon.

When fishing with large flies, employ single hooks; in small flies, double hooks are more advantageous.

This is the Canon of the Cast:

The line must straighten without slack, curve or loop from reel to fly, and the fly, ephemerally hovering, pitch to the water the briefest instant ere the line falls.

Some anglers prevent the recoil and doubling up of the line as it lengthens out on the cast, by holding a short length between the reel and the hand, which is freed at the instant the line pitches, thereby shooting the line out straight.

Some anglers shoot a considerable length of line, and consequently employ that method for casting long distance.

Always move the rod up stream so that the line is kept taut and activity maintained in the movement of the fly.

Always begin above the pool and fish down stream so that the fly is put over every inch of good water.

The fly should always swim beneath the surface; therefore waste no time in dry casting, skittering, skipping, or other surface movement.

Salmon lie immediately above the bottom of the river, and the fly should swim well beneath the surface.

The dip-dip (wriggle) of the rod causes the fly to dart forward and sag

backward, the wings and hackle opening outward, giving the idea of a living thing, sensing the food instinct.

The quiet, swift passing of the fly around the arc, carried downward by the current without life other than pointing 'gainst the tide—the mere passing before—tends to aggravation, play, etc.

Which is the better? Be apt in both!

The former motion violently waged (which also permits the fly to sink) will sometimes foul-hook the salmon and that, indeed, warrants the use, for then is a sagacious wit wanted.

Yet quoth Francis:

“That the angler should make the fly work so that the fiber-like pinions open and shut like a living thing is all chips and porridge!”

If the line is thrown directly across the stream it tends to bag, thereby making slack and giving the fly a dragged, dead appearance.

Consistently with a taut line, the fly can not move too slowly through the water.

The more down stream the cast is made, the slower the fly travels on the arc; hence, the greater the opportunity for the salmon to see the fly; the greater the ability of the salmon to seize the fly; the greater facility the angler has of gauging the line of travel and knowing where the salmon lies; the more power the angler has to maintain a straight, taut line and avoid bagging.

The fly must move actively to arouse the attention of the fish; have the appearance of endeavoring to escape, and so excite the passion of the salmon; therefore, in heavy water it is best not to wriggle the rod, or violently jerk the fly, but to trust to the stream to give motion and let the fly travel slowly and actively across the vision of the salmon.

When angling in quiet water, where, owing to the absence of swift current, the line doubles quickly, take in short lengths, with one hand holding it firm-

ly, so as to control the salmon, if he rise; meanwhile, wriggle the rod to give life to the fly.

When the salmon rises and misses the fly, hold the rod stationary, and draw the fly toward you by pulling the line through the guides by hand, without employing the reel, and before raising the rod for the cast. This has often provoked a rise, but its practice has caused many a mishap.

When you cast, in shore fishing, hold your position until you are about to withdraw the line for the next throw, then move downward and cast. Do not move until the cast is finished, as it will cause slack or bagging in the line.

Mark the exact spot where you stand when the salmon rises and misses, and if you are unsuccessful in re-raising the fish, return in half an hour or so and try the fly that induced the rise.

When the salmon rises and misses the fly, maintain your place, shorten the line by withdrawing it through the guides without reeling, hold it firmly and cast, gradually letting out line until you cover the water where the rise was. Thus you safely meet the contention that the salmon lurches forward when it rises and misses, and the other, that the salmon sags back to the former position whence the rise was made. This indeed requires a skilled angler, since it is fundamental that there shall be no slack, or line not in immediate use between the reel and the fly, when the cast is made.

Angling from the canoe disturbs the salmon in their resting place, as the boat passes over them; while wading along the margin, and thence casting, scarce sends a ripple across the pool.

Whether you angle from the canoe or from the shore, move quietly and deliberately, with the least possible noise and disturbance of the water.

In casting for salmon above or below rocks let this rule obtain: The angler must make due allowance for the fish lying above the cut-water of

the rock. The angler should assume that the fish is not lying in the eddy, boil or neutral water below the rock.

After you have unsuccessfully cast down the pool, try backing up before you leave. Cast diagonally across the pool, and immediately, but with great deliberation, take 2 or 3 steps up the pool, carefully noting the fly as it sweeps across, and continue until you have reached the head of the water.

When all expedients have failed to provoke a rise, try a dragging fly, slowly drifting down the stream or suffered to sink from line freed by the hand; but recover forcefully, not yielding an inch when the straightening line shows that the salmon has taken the fly deep under water without a roll or ripple to betray the rise.

Another resort of the desperate, clinging to the hope of one more last cast, is to cast straight across the pool and slowly reel in the line; but quickly must you release the winch when you feel the pluck or see the rise.

Have a care against this awkward moment: The swift movement of the fly as it is withdrawn for the cast often brings a savage rise, but the rod tears the fly from the salmon's mouth.

This theory have I tested to practical results:

When the salmon makes false rises, note well the resting place of the salmon, the angle of the cast as it lines out, and the point the fly reaches when the rise is seen.

A strike then, similar to trout work, will often hook the salmon.

You will perceive from the last practice, ground for the supposition that the salmon takes the fly and expels it in play in the so-called false rises.

If salmon repeatedly rise at, play around, follow or are pricked or rugged by the fly without being hooked, it is not unreasonable to assume that the fly is too big, and a smaller one should be tried.

Often carefully, while casting, examine your barbs, for when you have lost a fish, you then may note a fang-

less fly, broken by being hurled against the rod, caught against the reef or rock in the pool; or sometimes, broken inexplicably, from simply falling on the shingle.

Consider not that sunshine or darkness, calm, cloud or storm make the propitious hour for salmon angling; try them all in turn and season.

The masters accord in saying that the best hour for getting a rise is that of sunset; the half hour before and the half hour after.

If certainty for rising salmon exist at all, it is either on the first rising of the water, when it may not last beyond a quarter or a half an hour; or on the immediate subsiding of the water. Then it is exceedingly brief and as difficult to seize.

These be good angling hours:

Leisurely breakfast and cast from 9 a. m. to 12.30 p. m.

Lunch with restful comfort and angle from 3 p. m. to 6.30 p. m.

Also as humor and whim seize.

When the water is low, casting is most likely to be effective at sunrise and at dusk.

When the water is high, the best hours for angling will be found between 10 a. m. and 5 p. m.

Lengthful casting rives the cane rod, warps the wood rod, makes knots in the cast, breaks the flies or whips them off on the back cast, makes difficult control of the fly and often pricks the salmon. Manifestly of little utility in practical angling, it was conceived for vainglorious display and the exaltation of prize winning at tournament casting.

Proper length limit of beneficial casting is reached at about 70 feet, making sure that neither twist, double nor slack happens from reel to fly.

When angling from the boat, anchor on the dead water side of the pool and avoid traveling down the center, or crossing the water. This prevents disturbing the pool and leaves the salmon unmolested for backing up or a return visit.

Mind, when casting from the shingle, that the long backward throw often breaks the point of the hook on the rocks and stones.

Among methods of casting are the overhead, underhand, switch and spey. In its sphere, the switch cast is unrivalled.

Remember the backward sweep in the overhand cast should be returned by a movement of the tip describing a narrow oval on the return throw, or "smash down" as it is often called.

Direct return in casting will whip off flies.

Delay in return is liable to smash the barbs off the hooks on the backward throw.

This sums up playing the salmon:

Hold the rod well up and backward inclined, well bowed.

Strike not the salmon, nor snub nor twitch the line.

Maintain a taut line, suffering no slack nor bagging.

Lower the tip the instant the salmon leaps and instantly recover.

Patiently wait until the fish is exhausted before touching the gaff.

Permit naught to divert your attention from the rise to weighing.

From the moment the boil, roll or rise is seen until the salmon is felt, the rod should be held as motionless as possible.

"Never strike the salmon," was wisely said, but there is one exception—when the fish furiously leaps at the fly as it touches the water on the first cast; and even then do not strike.

The struggles of the salmon which embarb the fly should not be called striking.

If striking the salmon is ever permissible, it is only when the fish is rushing away from, and with his tail toward the angler.

Now, out of much contention, this may be taken without fear of contradiction:

Some anglers affirm that only striking from the reel should be done; that

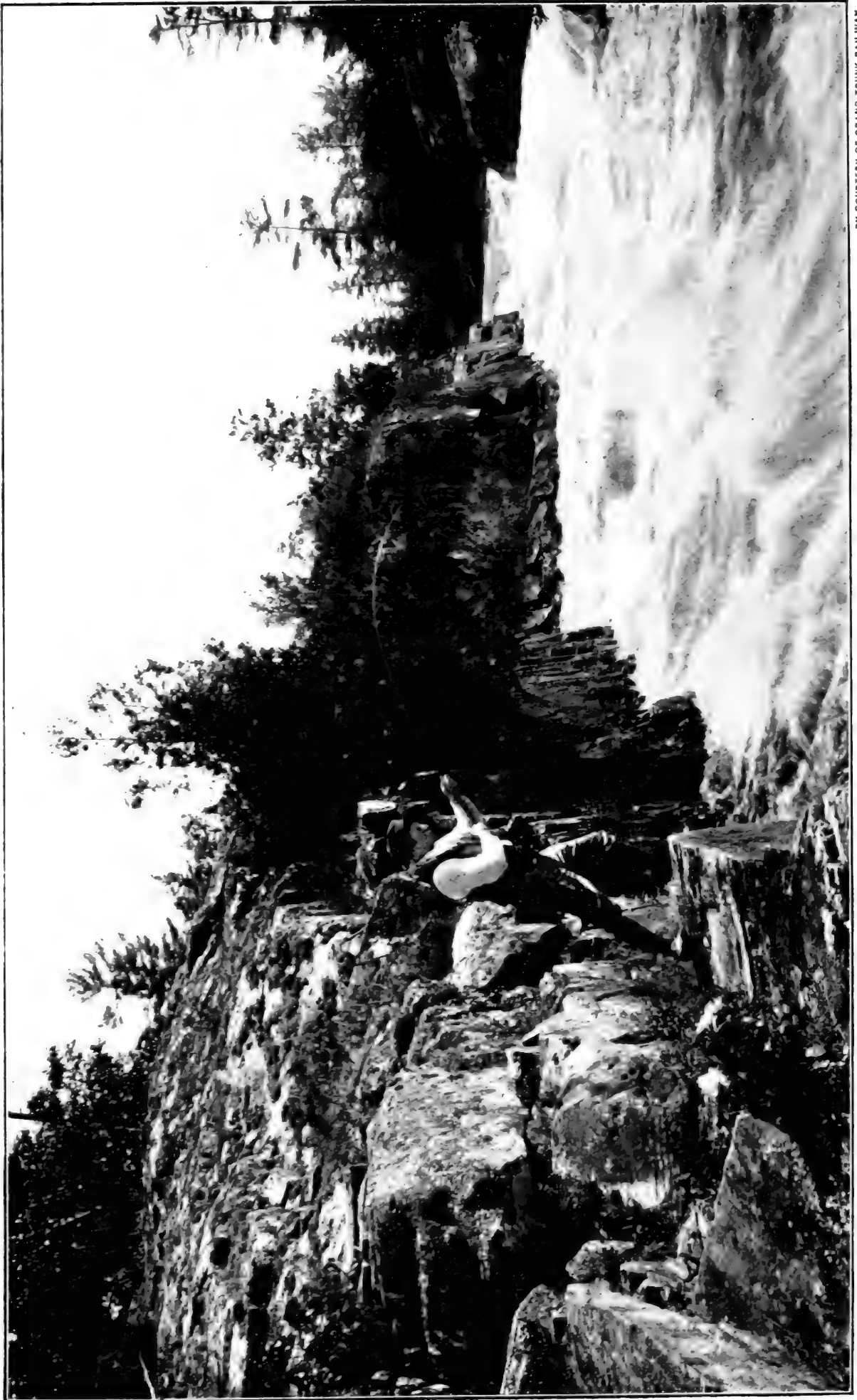

BY COURTESY OF GRAND TRUNK RAILWAY.

FRENCH RIVER, LAKE NIPISSING DISTRICT.

is, hooking the fish by the resistance of the reel in giving off line.

Others maintain that striking should be judiciously done at least and always when the fish is running away from the angler.

Still others declare that the index finger should always be kept on the line so as to give a modified strike when the salmon takes the fly.

But all unite in maintaining that there should be no strike until the salmon is plainly felt and known to be on the line.

Manifestly the salmon in rising and taking the fly moves toward and in the direction of the angler; therefore to strike at the sign of the rise and the feel of the pluck is to risk pulling the fly out of the salmon's jaw.

It is bad, nay, vicious, to strike or even raise the rod sharply at the sign of the boil or roll, and unpardonable at the open rise or splurge of the salmon, for you may pull the fly out of the sight of the salmon and disappoint the fish.

It is affirmed on authority that it is more difficult to raise a disappointed salmon than one that has been pricked or rugged.

When the salmon lashes or rolls on the surface, hold him as tenderly as possible, and without lowering the tip over much, with line as near slack as expediency will permit; for if the line be held firmly taut the salmon may hit it with his tail and then—!

While the salmon sulks it is known that the fish occupies a vertical and not a horizontal position, and hard straining or pulling in a direct line is not likely to move him. Change your position to get the sidewise pull and then try to move him, but first exhaust the pebbles.

It is not untimely to quote:

"If your gillie can dexterously manage to hit the line where it enters the water with a sharp, heavy flint, he will certainly spare you further trouble."

Some say a common split steel key ring put on the line, or a piece of pa-

per in the fashion of a kite messenger, will start the sulkiest brute of a salmon.

Do not hastily conclude that the fly is fastened to the bottom or a submerged branch, because you can not move or release the line, and you fear you will break the cast. A 16 pound salmon can hold to the bottom with a deathly stillness.

When you feel the salmon boring and jigging, that is, rubbing his jaws against the bottom to grind out the fly, hold the rod bowed until the vibrant shivering thrills up the tense line and down the rod into your marrow; but be ready to throw the rod forward with free reel when the salmon starts for the seaward run.

Success lies in holding the salmon within the pool. When the fish starts down the stream, hold hard to safety's verge, for in the rapids the expert deems it no slight feat to land the fish.

Giving the butt does not mean that the rod is to be held backward over the shoulder with the butt thrust toward the fish, but with the butt held against the groin and pulled strongly upward so as to put the strain on the middle joint and extending downward toward the butt.

Ease the strain on the rod without suffering slack when the fish rushes or makes toward you, and hold hardest, to em barb the hook, when the salmon rushes away from you.

When angling from the boat, neither raise the anchor nor move until the fish is well hooked; then the guide should closely get the canoe ashore.

If fishing from the shore, be sure to look around and take careful bearings of your surroundings as soon as you think the salmon has the fly, for a stumble is a fatal mishap.

Many anglers like to have the fish gaffed through the gills.

If your salmon get into the rapids when you are fishing from the shore, the gaffsman should wade out in the stream in readiness to free the line if

it should be caught by boulder or branch.

Never let the gaffsman strike at the salmon when the sun is shining in his eyes. In truth, a good gaffsman will not attempt it.

Never try to gaff a fish that is deep down, nor until it is fairly exhausted, which you will know when the silvery belly rolls up to the sky.

Salmon may be gaffed from the canoe, but landing the fish from the shore yields far better sport.

Shun the gaffsman who is slow or loth to get wet.

Truly is the landing net an impediment, and more fish have been lost by it than by the gaff.

In rainy and stormy weather, employ a heavy, 18-foot wood rod; on bright, sunny days, use a delicate, 16-foot cane rod.

The spliced rod is more pliant and willowy than the ferruled rod, has an even yielding give from butt to tip, and is not so apt to tear out the fly the moment the salmon seizes the lure.

On windy, stormy days, it is easy to cast a heavy tapered line on a stiff rod, while light lines will be blown against the rod in futile attempts to cast.

In boat fishing, the short, whippy rod is to be preferred to the long, heavy, stiff tool.

In casting from the shore with a long, heavy rod and in employing it in broken water, the line may be lifted over rocks and the fish held under better control than by a light, whippy rod.

Weight and thickness of lines must be proportioned to the rod; that is, a stiff rod requires a heavy line, a whippy rod requires a light, thin line.

Always take a spare or second rod with you to guard against accident while away from the camp, lest regret forever abide with you.

Avoid carrying your leaders on your hat. Gut will quickly rot when exposed to bright, hot sunshine.

Drawn gut is that which is scraped or filed down until it is of a uniform size, so as to be pulled through a hole to determine its uniformity.

Lines should be waterproofed and tapered, of a substantial size and not under 100 yards in length.

See that your line is absolutely smooth, and beware of rough places, breaks or kinks; you can find them by drawing the line through your fingers.

The best way of drying waders is to fill with dry warm bran, oats or barley, which should be shaken out as soon as it begins to cool.

Use old woolen clothing and a soft hat; avoid bright colors in your attire.

If you ask for the one thing in salmon angling that brings sorest disappointment and deepest chagrin, it is slack line between the fly and the reel, unguarded and uncontrolled; for who has not learned that salmon possess a satanic instinct for rising and taking the fly at that instant when the angler is utterly helpless.

Do not disquiet the salmon, disgust your guides and tire yourself by whipping the pool until your last chance of raising the salmon is gone. At least make some endeavor to discover the propitious moment by intervals of rest beneficial to the salmon, your guides and yourself by studying the conditions of water, weather and flies.

Remember there are miles of live and active water in the river where the salmon do not lie.

Multitudinous are the reasons and 2 good methods exist to ascertain the pools:

Get an old guide well acquainted with the river.

Go over the water until you learn the pools.

Where the river is in freshet the salmon will leave the normal pools and then for the time being you must seek them in strange places; with the subsidence of water you will be sure to find them in the accustomed places.



PIN CUSHIONS.

AMATEUR PHOTO BY W. J. BUNDY.

Winner of 17th Prize in RECREATION'S 8th Annual Photo Competition.

RED BREASTED MERGANSER.

ALLAN BROOKS.

The mergansers, more generally known as sawbills, or shelldrakes, are represented on the North American continent by 3 species, the goosander, or American merganser, the red breasted merganser, and the hooded merganser; with a 4th, the smew, as an occasional straggler from Europe.

The males of the goosander and red breasted merganser are easily distinguished, the latter having a spotted breast band, and handsomely marked flanks, against the im-

spring, when the larger species has already laid its eggs. I have never found the red breasted species breeding in Southern British Columbia.

Both the larger species feed almost exclusively on fish, and do more damage than any other fish-eating bird. Where they frequent salmon or trout streams they should be killed whenever possible. I know of numbers of streams that are ruined for fishing by the depredations of sawbills and



RED BREASTED MERGANSER. *MERGANSER SERRATOR*.

maculate lower surface of the goosander.

The females of the 2 species are much alike, those of the red breasted species being the smaller with proportionately longer bills. The red breasted merganser seems to be a much more maritime bird than its congener. In British Columbia the red breasted merganser is seldom seen on the fresh water rivers and lakes until the breeding season is at hand. It has a more Northerly breeding range than the goosander, and migrates Northward late in the

herons. The number of small fry a merganser can consume is almost incredible, and where fish are plentiful these birds do not cease feeding until full to the throat.

As might be expected from their diet, their flesh is at all times uneatable, unlike that of the hooded merganser, which, feeding as it does mostly on water insects, is generally a fair table bird.

In the red breasted merganser the iris is brown in the male and yellow in the female; bill carmine to reddish, with the culmen dusky; feet bright red.

Indiscretion is the better part of love.--Life.

WILD ANIMALS AND BIRDS IN THE NORTHWEST

G. O. SHIELDS.

It is a fact well known to all naturalists that wild animals and birds adapt themselves to their environment and that the habits of a given species in one locality can not be taken as a guide to what indi-

cially a meat eater, and his depredations on live stock have resulted in large bounties being offered for his destruction in the cattle States. In Western Canada the grizzly can rarely be induced to eat meat.



WINNER OF MANY BATTLES.

viduals of the same species may do in another section. I saw many evidences of this in my sojourn in the Canadian Rockies last summer. The various species of bear found in the Western States are fond of meat of any kind. The grizzly is espe-

Trappers kill goats, sheep, moose, caribou and smaller animals to bait their bear traps with, but they seldom succeed in taking a bear with any such bait. The grizzly of that region subsists almost entirely on vegetable food. He is fond of bulbous and

tuberous roots and of grass. He occasionally eats berries, though he does not seem to care so much for them as his cousins in Wyoming, Montana, Utah and other Western States do. On these latter ranges the grizzly, as well as the black bear, eats great quantities of berries in the late summer and autumn. Even there they will always pass a fat berry patch to lunch on a steer, or on the carcass of an elk; but if they do not find meat, then they fill up on berries. On the other hand, the grizzly of the Western States does little digging for roots.

In the Canadian Northwest we found thousands of small excavations where the grizzlies and the black bears had dug for their food, and we frequently saw evidences of their having torn up rotten logs to get worms.

While hunting grizzlies in the Selkirks, in the spring of 1902, we found that in the early spring they live almost entirely on the roots of certain lilies and other bulbous plants. On the Continental divide, in British Columbia and Alberta, we found the same species of plants growing, but the bears there pay little or no attention to them. They did, however, feed on other roots. At one place on the Bow river we found a flat which is overflowed every spring, and on which grows profusely a small vine that has a starchy, bulbous root. This flat had been dug over by bears until it looked like a potato patch after the farmer has gathered his crop.

The Northwestern bears are also fond of grass, and the black bear, especially, in that region, grazes like a cow. We found small meadows where the grass was eaten off close to the ground, over considerable areas, and the tracks in the soft earth showed that the work had been done by bruin.

While, as I have said, the grizzly in the Canadian Northwest does not seem to hanker after meat in general, he does prey on the Columbian ground squirrel, which is abundant there. We saw numerous small excavations in which we could read the signs of miniature tragedies. This ground squirrel rarely burrows to a depth of more than 18 inches to 2 feet, and it is comparatively easy for a bear to dig out one of them. A ground squirrel would only make a bite for a big grizzly, but inasmuch as old Ephraim lives almost wholly on vegetable food, a squirrel now and then, by way of dessert, would seem to answer all his requirements.

I have told in another place about finding where a grizzly had apparently dug out a whole family of marmots, on top of a mountain. That old chap must have been meat hungry, for he went 5 feet into the solid earth to get his dinner, and the ex-

cavation at the top measured 9 by 12 feet.

In Eastern Canada and in Newfoundland the caribou inhabits the lowlands almost exclusively. On the island he lives mainly in the marshes and becomes in fact a semi-aquatic animal.

In British Columbia he is found in summer and autumn at altitudes of 5,000 to 9,000 feet. Of course he goes down into the valleys and canyons in winter; but as soon as the snow begins to melt in the spring he begins to climb. There is one mountain near the line of the Canadian Pacific railroad which has on its summit a tableland, at an altitude of 7,500 feet, which is the summer home of large numbers of caribou. The lowest altitudes in that region where the caribou winter are at least 5,000 feet. The winter food of these animals consists chiefly of moss which grows on the dead branches of spruce trees, and I am told the caribou also eat brush.

The mountain sheep seems to reach his greatest development in Southern and Eastern British Columbia and in Western Alberta. I bought at Banff the head of a sheep, supposed to have been killed on the head waters of the Saskatchewan river, that is one of the finest specimens I have ever seen. Photographs of this head are shown herewith. The horns measure 16½ inches in circumference at the base, and 16 inches out from the base they still register 16 inches, having tapered only ½ inch in that distance. The length of the horns is 39 inches and the spread is 17. The horns make nearly a complete turn, and if they had been allowed to grow without interruption the points would undoubtedly have passed the starting point; but the old patriarch who carried this head was a valiant fighter. He evidently spent his life looking for trouble, for the horns are worn and battered from base to tip, and at least 6 inches have been broken from the points of both horns.

The horns and skull weighed, before mounting, 39 pounds. There are longer horns in existence, but I have seen none that carried their massive size so far out from the skull.

The pugnacious disposition of the mountain ram is well illustrated in this specimen. A heavy blow with a hammer makes little or no impression on one of these horns, and from this a faint idea may be obtained of the terrific battles these rams wage, on their native hills.

The head of the big sheep was mounted by John Murgatroyd, 18 North William Street, New York City, who, as the picture shows, has done an admirable piece of work on it, and it is only fair and just to him to make this statement here.

There was another head, in the

same collection from which I got this, that I was strongly tempted to buy on account of its condition. The horns were not so large as those I bought, but the veteran who bore them must have spent his life in waging war. Large pieces of the flinty substance of which the horns were made had been broken away by fighting, and apparently 4 or 5 inches had been battered off the tip of each horn. Many collectors do not want sheep horns that are broken in any way, but to me one of the most interesting features of this pair, as

same kinds of vegetation that grow in the Canadian Northwest. The few deer we saw signs of were solitary. We never found tracks of more than one in a place, and we often remarked on the strange disposition of a deer that would choose to live in that great wilderness entirely alone.

We saw a few rabbits, a few whistling marmots, now and then a red squirrel, and an occasional track of a fox or a coyote; and we were serenaded by small bands of the latter on 2 or 3 occasions.



BEFORE TAKING THE SCALP TREATMENT.

well as the 2 other pairs I have, is that they show the indomitable courage and valor of the animal.

Several of the largest sheep heads in existence are known to have come from the Kootenai country, the Saskatchewan or the Sun Wapta regions.

There are a few mule deer on the Continental divide. We saw tracks during the summer of perhaps a dozen, but did not get a glimpse of one of the animals. Whether the winters are too severe there for the mule deer to flourish, or whether the right kind of food does not grow, I am unable to say; but he is found in higher altitudes elsewhere, and lives on the

We saw numerous signs of marten, but none of beaver or otter, except some old workings of the former. Years ago the beaver was plentiful in that country, but the accursed trappers have cleaned them out.

William Brewster told me an interesting story of a beaver he saw on the Big Smoky river, a tributary of the Peace river, some years ago. The beaver had evidently been disturbed by a man, or some other animal, at his home, and had lit out for some point down the river. He was swimming rapidly with the current, but occasionally would stop, turn his head up stream, look and listen a few minutes, as

if trying to find out whether he was being followed. Then he would turn suddenly again, slap the water with his tail and paddle off down stream as if trying to catch an express train.

Brewster said he found black bear and moose abundant in that section of the country. He had started with a party of prospectors for the Klondike, by way of the so-called Edmonton trail. They traveled all summer, and a day rarely passed in which they did not see one or more bear or moose. He said that occasionally when tramping alone he would meet a bear face to face in the trail, and would get within a few feet of him before the animal would see or smell him. Then the bear would rise, look at the intruder a few seconds, utter his familiar "woof!" drop on all fours and go for cover. Brewster said that apparently he was the first man most of these bears had ever met.

A flock of 11 wild geese summered on the Bow river and the Bow lakes. We saw and heard them several times in June and July, while camping or traveling on those waters. All other waterfowl, as well as smaller birds, were supposed to have been divided up into pairs, and to have been busy raising families at that season of the year; but for some strange reason this colony of geese were neglecting their domestic duties.

We found a number of female mallards and a few of other species of ducks on the small lakes along the trail, with broods of young. We frequently crept up within a few feet of these families before they discovered our presence, and it was most interesting to see the mother duck start for the middle of the lake, calling her children, and to see the fluffy little balls form into a V and follow her. They seemed to rest as lightly on the water as if they had been made of dandelion fuzz, yet they had great propelling power in their little feet and legs, for they made good speed over the water.

The fish hawk is up there, too; and he lives high in more than one sense. Almost the only fish to be found in those Northern waters is the trout, and we frequently saw an osprey sailing over us with a good sized trout in his talons, which we would have been glad to have for our own breakfast.

We saw 3 distinct species of frogs and 4 of toads. The latter were especially numerous, everywhere along the trail.

A taxidermist in Banff told me he had gone up the river some miles from there to see a forest fire that was raging in the mountains. When he got within a mile of the fire line he saw large numbers of humming birds coming from near the burnt district. He said he counted 40 of these little

refugees within a few feet of him, at one time.

We found the willow ptarmigan on top of nearly every mountain we climbed. These birds live almost entirely above timber line, though occasionally they descend into the scrubby timber that grows high up on the mountain side.

The blue grouse was also frequently met on the high mountain sides, well up toward timber line. Wright made a number of photographs of ptarmigan and fool hens, also one of a blue grouse and 2 of her chicks.

He caught a young sanderling one day, which was not larger than a good sized hazlenut. He put it in his pocket, intending to take it to camp and photograph it; but when he reached camp and went down in his pocket, he found the little prisoner had escaped.

One day after pitching our camp and starting our fire we saw a ground sparrow flitting about the camp and appearing uneasy. We watched her a few minutes, and saw her hovering over a certain spot. We went there and found her nest, which contained 4 babies that were apparently not more than a week old. The nest was within 10 feet of our camp fire, and we were tempted to move the fire in order that the mother bird might not be disturbed in her home. We concluded, however, this would entail too much work, and were glad to find that after a few minutes she became entirely reconciled to our presence. She went away and came back in a few minutes with a tiny bug, which she placed in the gaping mouth of one of her young. Then she went on about her domestic duties as if nothing had happened. In the course of the afternoon she visited her nest perhaps a dozen times with food. At sundown she settled over her babies, and sheltered them through the night. We went to her nest several times after dark, and though the light of the camp fire glistened in her tiny eyes, she would let us come within a foot of her without appearing in the least frightened. We pulled out the next day and left her in quiet possession of her home, and I trust she may have succeeded in rearing her babies safely.

Soon after leaving that camp a moose bird joined us, and followed us over 2 hours, during which we covered 5 or 6 miles. He would fly along toward the head of the pack train, alight within a foot or 2 of the trail, either on a log or on the ground, watch us and the horses as we passed, and as soon as the tail end of the procession had passed him he would make another flight; and keep repeating this performance. Once he lit on Buck's back, and another time on one of Tom's stirrups. I tried several times to catch him,

and though he would let me put my hand within 6 inches of him, he would slip out just in time to prevent my getting hold of him. I had some crackers in my pocket and offered him some crumbs from them, but he did not seem to care for them. He occasionally picked up a bug as we went along, but had no taste for manufactured food. On another part of the trip one of these birds joined us and followed us over an hour. At the end of that time we made camp, and he visited with us and the horses all the afternoon. We hoped he would join us on the march again the next morning, but before we pulled out he quit us.

Although we saw in the aggregate many interesting birds and animals, yet that country is a lonely one. Sometimes we would travel a whole day without seeing a living creature of any kind; yet the coun-

try is so thoroughly wild and so entirely uninhabited by human beings that it would seem wild creatures of all kinds should abound there. Game was plentiful there years ago, but the vandal, man, has well nigh cleaned it out. There are plenty of goats left, and in limited districts a good many sheep; but the Indians and the white trappers, who encourage the red men in their skin hunting and head hunting, have marked the doom of all big game in that country. Alberta has a law prohibiting white men from buying heads or skins of game animals from the Indians; and if the Government would only enforce it there would be sheep, goats, caribou and bear in that country a hundred years hence; but the Government officers seem to feel no interest in the protection of these animals and allow certain traders to carry on their unlawful work openly, without even being warned.



AMATEUR PHOTO BY H. N. FRASER.

A PHOTO OF MYSELF BY MYSELF.



THE TOWHEES SEARCHED THE OPEN PLACES.

THE BROWN TOWHEE.

DR. BARTON W. EVERMANN.

Near the mouth of the canyon is a copsy tangle of prickly pear, sage brush and live oak. From March until October to these is added a rich mass of chilacote vines, which run riot over and among the bushes and cactus to which they cling. The dark waxy green of the live oak, the paler, shining green of the cactus, the still paler green of the chilacote, and the dull, white-dusted green of the sage blend most harmoniously.

Near the center of the copse a wood rat had built his unnecessarily ample home of sticks, dirt and leaves. The ground underneath was dry and dusty and full of holes. Some of these the wood rat doubtless used on occasion, but most belonged to a family of spermophiles, curious rodents with flat, bushy tails and resembling gray squirrels. Many other animals visited this copse, some every day, some rarely. Little gray rabbits would run in now and then to escape the too persistent dog, or to look in on the wood rat and their other friends; and their big cousin, the jack rabbit, with the kangaroo's legs and the donkey's ears, would drop in when he wished to rest in the shade.

Lopho and *Ortyx*, the quails, would sometimes bring their families and clean up the small seeds on the ground. Old Sicklebill, the thrasher, was a permanent resident, for was not his nest carefully hidden among the chilacote vines? There, too, Modesty Itself, the brown towhee, had her home. It was in the first days of early spring that she came to this copse. With her was another equally brown and just as modest. So alike were they in appearance and behavior that I was not always sure I knew one from the other. They were each a soft, olive brown above, a little richer on the head and rump, while beneath was a cleaner, paler brown. Never did colors of bird blend more completely with those about it or furnish a better example of protective coloration. When the towhees had any suspicion that an enemy was near, they had a habit of remaining perfectly still among the dead leaves and sticks, and it then required sharp eyes to see just where they were. As to behavior, they were, indeed, modesty itself; never noisy nor unseemly in their ways. Their every movement was with a quiet dignity rarely seen among birds or men. Every word that either spoke was decorous and proper in the extreme; in marked contrast with the California jay, that is always talking and always using words not fit to print.

Though quiet, they were always happy; that could be seen as plain as day. Un-

like the jay and old Sicklebill, they were not given to moods. They rarely became noticeably excited or angry, and only for sufficient cause. The spring was one long honeymoon, and the summer and fall full of the joys of a happy home and a growing family.

When they first came to this copse they were quick to see its advantages. Its closely interlacing branches at the ground afforded them a safe retreat if *Accipiter*, he of the sharp shin and cruel eye, should attempt their destruction. On the matted branches among the intertwining vines of the chilacote they were secure at night from the attacks of *Strix*, the barn owl. In the pool beneath the huge rock in the arroyo near was water to slake their thirst during the terrible drought which from May to October comes to this Southland of California. In the canyon and on the foothills were wild oats and many kinds of weeds whose seeds are good for towhees. Beneath the dead leaves which formed great beds under every clump of bushes in the canyon were insect larvæ, small beetles, bugs and worms, of which young towhees are so fond. Near the base of a spreading sage brush in the edge of the copse they found an ideal place for the nest they wished to build, a spot well protected from the sun and from the many enemies of the ground-nesting birds of that land.

So there, in early April, they built a shapely nest of twigs, grass and fine strips of bark, and lined it inside with delicate root fibers and soft sheeps' wool. Not an elaborate nest, nor extreme in artistic beauty, but large and substantial; and its colors had been selected with excellent taste so well they matched the surroundings.

The building of the nest was a matter of but a short time, and when I looked in on them a few days later there were in it 5 as handsome eggs as any towhee would care to have. Until then the cares of life had been few; but with the building of the nest and the filling of it with eggs, life became more serious. Along with ambition and hope came anxiety and fear. Still they remained the same quiet, respectful birds they had always been. They never quarreled with other birds nor bothered the least with their affairs; their own duties and simple pleasures were enough to keep them employed. Old Sicklebill, the thrasher, was at the copse every day, sometimes hopping awkwardly about and scratching among the sticks and dead leaves; sometimes moving about among the branches

and vines for no reason at all, as far as anyone could see. At other times, especially early in the morning, and again late in the afternoon, when his mate would be sitting on the nest down among the chilacote vines, he would mount to the topmost limb of the live oak of the copse and pour forth his soul in song. True, it was not a great song, such as his relative, the mocking bird, sings day and night in that land; nor was it so fine as another relative, the brown thrasher of the East, often sings on similar occasions; nor was it ever so sweet as a more distant relation, the catbird, favors us with when he has discovered the poetry of everyday life. For old Sicklebill is a modest bird and rarely sings for the public; his hope is that she who sits among the chilacote vines may hear his song and be pleased.

He never molested the brown towhee. Each seemed to understand the other perfectly, and each respected the other's rights. They talked to each other a bit now and then, but so sedately that one could never guess what they really said. Very different it is with the California jay, who is a Frenchman, his motions most profuse and quite as expressive as his words. If he could not jerk his tail, nod his head and shrug his shoulders, he might not be able to talk at all.

But Modesty Itself and old Sicklebill paid little attention to him, and the jay had no influence in the community; in which respect he is not unlike other people who talk more than they should.

Modesty Itself never wandered far from the copse in which she had her nest. Two or 3 times every day she would go to the pool in the usually dry bed of Santa Paula creek, for even towhees will take some chances in order to get water to drink; but it was only a few rods away and the danger was not great. She and her mate had their regular hunting grounds, all within a few yards of the copse. They usually went over the entire area every day, turning over the sticks and leaves and scratching in the dirt each day just as if they had never hunted in that region before. They would search every nook and corner of the copse, then they would examine with equal care the more open spaces where the peonies and burr clover grow in early spring, and in the evening they might be seen playing in the dust of the public road which ran near. Often while taking their dust bath they would be disturbed by some passer-by, when, with a quick flirt of the tail they would fly hurriedly into the deepest recesses of the copse, where they would remain until all danger was past. They soon came to know their friends. One who passed every day and often stopped to observe their ways never treated them ill, and they felt that

no harm could come from being sociable with him; so they came near when he tarried long and told him things which he was glad to know.

But there were those who passed by on the road who never failed to give the birds a scare. Some were boys who would throw stones or sticks at them, or frighten them with noises which they could never understand; but nature has a way of caring for her own, and our brown towhees were usually under cover before these passers got a glimpse of them. The plain modest brown of their simple dress blended so admirably with the color of the ground and dead leaves that it was not easy to see that any bird was there. Then they were quiet birds, moving but little and slowly, which assisted in obscuring them.

Thus the spring passed. When after a little, the eggs had been hatched and 5 lusty young had to be fed, the question of food supply became a serious one. The old birds were kept busy and had to go farther from the copse than they had gone before; for small grubs, worms and insect larvæ that were soft enough and not too large for the young birds were not so common that they could be found anywhere. Both old birds never left the copse at the same time. If Modesty Itself went to search for special food among the leaves and sticks down by the irrigating ditch, her mate always remained within calling distance of the little ones.

The young birds grew rapidly. When the mother brought them food all were eager to seize it, stretching their necks and opening their mouths in a way that was not at all polite, modesty not being a trait of young birds of any kind; but they fared well, and long before the end of June all were lusty and brave. So large had they grown that the nest could no longer hold them all, and the larger, stronger ones, not enjoying a crowded home, began to crawl up on the border of the nest, where it was so nice and cool. At first they found it no easy matter to balance themselves; but soon they were able to stand with their pale little legs straight and their heads held up jauntily. Then they would stretch their legs and necks and try their wings, and gradually many sets of tiny muscles came to work together as they should. Soon the birds began to venture cautiously out on the limbs, and proud little birds they were when able to balance on so slender a support. If the young birds seemed over timid the mother would encourage them by moving out slowly on the limb. Then she would coax them to try their little wings by taking short flights herself from branch to branch. This seemed, to their inexperience, a daring

thing to do; but once done, how simple and easy it proved!

It was not long after these first short flights until the 5 young towhees could fly up and away with the best of their kind. Modesty Itself and her mate kept with them during most of the summer, for so successful had they been with this brood that no second nest was built that year. When the young birds had grown as large as their parents, and their coats had become the same soft brown, the family did not always remain together; but at night they would come together again among the

thick foliage of the big live oak by the irrigating ditch.

Thus they lived through the long, dry fall and rainy winter. Spring came again. The alfillarilla and the dark brown peonies were in bloom and the chilacote vines again ran riot over the clump of chaparral. Then the towhees paired again and new homes were made. Modesty Itself and her mate built again in the copsy tangle where we first saw them.

Let us hope that this and the years to follow proved no less happy than was the one during which we knew them so well.



ANONYMOUS.

A COZY RETREAT.

Winner of 25th Prize in RECREATION'S 8th Annual Photo Competition.

WHIP-POOR-WILL.

F. A. JOHNSON.

When the old stone walls are gray in the shadow,
And the campus is lonely and still,
Then I seem to hear from my window,
As at home on the brush-grown hill,
That lingering, dolorous, wavering cry
That rises and pleads till the echoes die
In gloomy vale and evening sky—
The heart-thrilling call of the Whip-Poor-Will.

If you'd heard it once in the mountain land,
And knew how it lures and thrills,
It might be then you could understand
The power of a love for the hills!
You might understand how memory clings!
You might understand what a fond note brings,
How sweetly sad the whole strain rings—
The lingerying cry of the Whip-Poor-Will.

Estate Agent (to Laborer's Son)—Here, my boy, where can I find your father?

Boy—In the pig sty, sir. You'll know 'im by 'is brown 'at.—Punch.



A FLYING LEAP.



GETTING UP IN THE WORLD.

AMATEUR PHOTOS BY CHAS. E. TESS.

Winners of 23d Prize in RECREATION'S 8th Annual Photo Competition.
Made with a Korona Camera.

JOE BEDORE OF ST. CLAIR FLATS.

H. W. BRADLEY.

Heverybody know heem, ole Joe Bedore;
Hany mans can tell you dat.
'E keep de bes' place laike you see before
Hon top hof de San Clair Flat.
'Es waife he cook eet, de boss pea soup,
You say jus' de same wen you straike
eet;
But dose leetle wite bean make de bes' pea
soup;
Dat's de bes' kin' of soup wat Ah laike
eet.

Joe Bedore halways got eet, de 4 kin' of
feesh,
Le tritt an' de big lake trout;
De poisson blanc an' de fat wite feesh,
She's so fat dat she'll melt on your
mout.
An' dere's wan more t'ing dat's de bes' hof
eet h'all,
An' dat ees de gran' mushrat.
Joe Bedore got hall hon hees tab, hevery
fall,
Hon top hof de San Clair Flat.

Wen de wintaire taim come, an' de hicc
ees fine,
Han' you stan' hon de door some day,
You see a beeg smoke, laike dey burn eet, de
pine,
'Bout 3 or 2 mile away;
Wen she come along close, you see eet ees
Joe,
Drav so fas' dat hees loos hees hat;
E's drav eet hees pony, de little Tebo,
Hon top hof de San Clair Flat.

Some of dose feller come hup an' tell Joe
"Wot's de rizzon you stay hon de
h'woods?
Wat for you don' go down to hole Buffalo.
Dat's de place you, for sure, make eet
good."
Den Bedore he'll say, "Ah look eet dees
way,
W'en Ah'm here Ah know w'ere Ah'm at.
Ah jus' t'ink Ah stay an' Ah'l spend hall
my day'
Hon top hof de San Clair Flat."

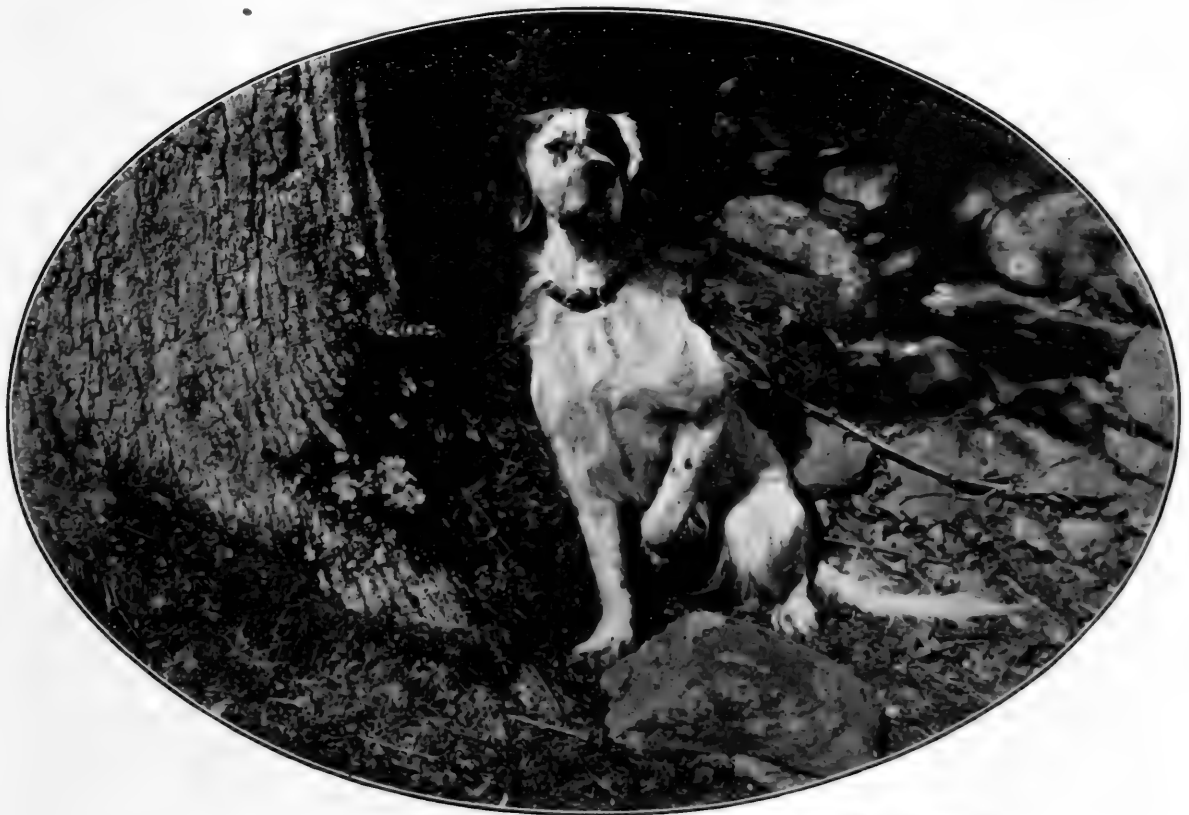

AMATEUR PHOTO BY S. G. JAMESON.

YES, SIR!

Winner of 14th Prize in RECREATION'S 8th Annual Photo Competition.

IN THE COAST RANGE.

D. E. WYNKOOP.

From Puget sound South nearly to the Northern boundary of California lies a strip of territory not often invaded by the sportsman tourist; yet its endless variety of mountains, gorges and dashing streams, broad fertile valleys, vast timber and game reserves and its superb climate combine to make it a land of delight for the traveling pleasure seeker. One can see objects 20 to 30 feet below the surface of the clear, cold waters of lakes or still pools in the rivers, while the depth does not seem half so great as it really is. Here at Salem, looking East from the dome of the Capitol building one can see the snow capped peaks of Hood, Wilson and Jefferson mountains. To the Westward at about an equal distance is the broad Pacific.

I realize that the name Pacific is most appropriate to that vast expanse of water, for I went out several miles on its placid bosom in a row boat. I caught several fish, among them cod, bass and a bright yellow fish called a grouper. The water teemed with life. I saw 2 whales and many seals and sea lions, besides numberless fish, in my sojourn of 5 days at Ocean Park.

The beautiful Chinook salmon were just running up the Nestachee river to spawn, and I saw a farmer with a load of 35, which he said weighed nearly 700 pounds. Game of nearly all kinds is abundant, especially deer, black and brown bear, California quails and Mongolian pheasants.

I heard so much about hunting bear that I visited the region where the animals are said to be most numerous; namely, the coast range of Southwestern Oregon. Arriving July 13th at the place recommended to me, the ranch of a guide named Fetter, I made arrangements for a 3 days' trip in the mountains. Leaving the ranch early on the morning of the 14th we went with our pack ponies and bear dogs to a certain slide, or washout, in the mountains. My guide said he seldom visited that place without securing deer, mountain lions, bear, or elk. The open season for deer begins July 15th, which I consider much too early, and as elk killing is prohibited, the only game I cared to see was a bear or a cougar.

Nearly all day we trailed along a narrow canyon leading up a mountain 7,000 feet above sea level. About 5 o'clock we reached the slide, which was nearly a mile long. There we camped for the night. During

our trip up the mountain the guide had loosed the dogs. One, the best bear dog, had gone off on the trail of some animal and we did not see him again until we returned to the ranch.

The next morning we started down the slide through an almost impenetrable thicket of fern, maple and alder. We had not been out more than an hour when I became separated from my guide. The tangle of brush and chapperal seemed to grow more dense and I looked with apprehension at the hollows made through the fern by bear in quest of skunk cabbage. Perhaps an hour had passed since I saw the guide when I heard a shot far over on the other side of the slide. Waiting a few moments and not hearing any further noise I made my way in the direction whence I had heard the shot. After a struggle through the tangle I came to where the guide had shot and wounded a large bear. Together we trailed the wounded animal for the greater part of the day, until the guide said we would better give up the chase if we wanted to reach camp before sundown.

After resting our tired bodies for the night beneath the overhanging boughs of a yellow fir, we set out in the morning of the third day in a new direction to the top of the mountain. We crawled through fern 7 feet high, along ledges, over fallen timber and down rocky runs. Occasionally we saw footprints of deer or bear crossing some mossy mound or open spot. About 3 p. m. we came to a trail which led to camp and were slowly picking our way along when, not more than 50 yards away, I heard a sharp crackling of twigs as if some heavy animal had started to run. Instinctively I tightened the grasp on my rifle and retracing a few steps I saw a bear bounding along about 80 yards away. I quickly sent a bullet from my Savage flying after him and he disappeared from view. Where I had last seen the bear I found a trail of blood and had not followed it far until I saw the animal's head peeping from between 2 rocks. I gave him another bullet, this time through the head, and killed my first bear.

I later visited the Grande Ronde Indian reservation and saw old Fort Yamhill still standing, a monument to the red man's love for his home. No wonder the Indian loved and fought for this grand old hazy summerland of indolence and repose.

Mamie—What is biology?

Gladys—I suppose it's the science of shopping.—Chicago Daily News.



AMATEUR PHOTO BY G. W. FISK JR.

DEFIANCE.

Winner of 20th Prize in RECREATION'S 8th Annual Photo Competition.
Made with a Wizard Camera.



AMATEUR PHOTO BY G. J. NEWGARDEN.

HUMMING BIRD.

Winner of 21st Prize in RECREATION'S 8th Annual Photo Competition.
Made with a Cycle Poco Camera, Zeiss Lens.



AMATEUR PHOTO BY C. V. ODEN

AMERICAN GOSHAWK.

Winner of 24th Prize in RECREATION'S 8th Annual Photo Competition.
Made with a Cycle Wizard Sr. Camera.



AMATEUR PHOTO BY DR. E. A. FRENC.

CANADA GOOSE.

Winner of 28th Prize in RECREATION'S 8th Annual Photo Competition.
Made with a Cartridge Kodak.

MINNESOTA RAZORBACKS.

C. E. Smith, S. V. Hanft, and J. B. Donnelly came into Minneapolis loaded with bass, pike and pickerel, the result of 4 hours' sport at Fish and Trap lake, Lincoln, Minn.

The entire catch weighed 148 pounds, and consisted of 18 pike, 10 bass and 10 pickerel. The weight of the largest pike was 8 pounds, the

did not reply. Donnelly answered, confirming. He seems to be the only pig in the herd who is devoid of all sense of decency. They are all degenerate reprobates or they would never have stood up in front of a



C. E. SMITH, S. V. HANFT, J. B. DONNELLY.

largest bass about 6 pounds, while the heaviest pickerel tipped the scales at 12 pounds.—Minneapolis Times.

I wrote all 3 of these razorbacks and asked them for confirmation of the above report, but Hanft and Smith had evidently become ashamed of their butchery and so

camera with a string of dead fish. It would have been a blessing to the community in which they live if some one of the fish they ate had been diseased to such an extent as to poison all 3 of them. Smith's number in the pen is 1,001, Hanft's 1,002 and Donnelly's 1,003.—EDITOR.

HOW TO BUILD A MACKINAC BOAT.

FRED A. HUNT.

In any place where ponds, lakes and sluggish streams occur most anglers like to use a boat adapted for fishing and yet not exorbitant in price. A mackinac costs little and any ingenious boy can build one. These boats are durable and safe. In rice swamps or the Detroit flats a canoe or punt is more desirable, as the draft of either is small. A mackinac draws more than a canoe, but the oarsman can sit comfortably in a mackinac and does not need to be an acrobat to remain in the boat, as he does in a canoe.

To commence the construction of a mackinac: Draw a straight line on the sand, the ground or a barn floor, remembering that the mackinac is a flat bottomed boat. This line should be a little longer than you desire the boat to be. Six feet is a handy length for one person. On this line (B A) construct a skeleton diagram as follows:

lines from B to A, will determine the size of the floor stanchions, of course, by taking the distance on each side of the central line, and 12 or 14 inches being the height of the side stanchions.

Commence the framework by making the floor beams and stanchions, taking B1 as a specimen. This is made of 2 inch x 4 inch clear scantling, the 4 inch part being placed toward the floor and bulwarks and firmly nailed, and the upper crosspiece being 2 inches below the upper ends. B2 is made the same way. B3 is without any upper crosspiece, B4 with one, B5 without and B6 with. The planks for the floor should be of good, wide, clear pine. Use one plank for the center, the center line B A taking the middle of the plank. Put the other planks on the sides of the center and turn the ends and edges to conform to the diagram, the edges being cut perfectly

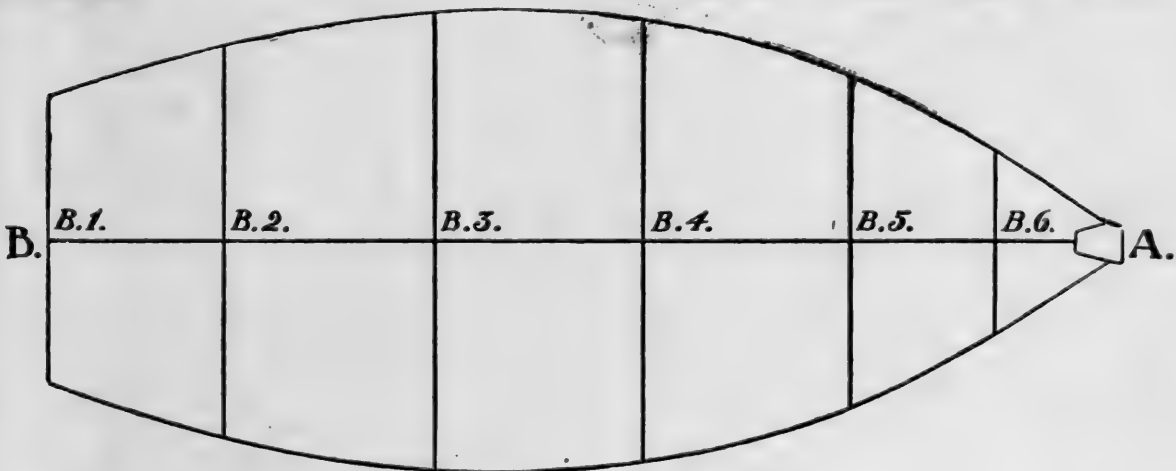

SCALE 1 INCH TO THE FOOT

In this skeleton the transverse lines B1 to B6 are the floor braces and stanchions. A, the stem, is made of a 3x3 inch timber of sound pine, 2 inches higher than the gunwale, and shaped something like a blunt nosed V, to accommodate the ends of the planks and the arcs on the sides of the projected boat. For a 6 foot boat the line from B to A will be 6 feet long and the line at B1 should be 20 inches, 10 inches on either side of the center line. From the extremities of this line the curved lines to the stem are drawn, and the distances between the stern line and the stem, as shown by the transverse lines of the diagram, are as follows: B1 to B2, 12 inches; B2 to B3, B3 to B4, B4 to B5, 14 inches each; B5 to B6, 10 inches; and B6 to the stem takes the remaining dimension. The swell of the bulwarks, the curved

square and the edges of the planks being made square and true, as the less space

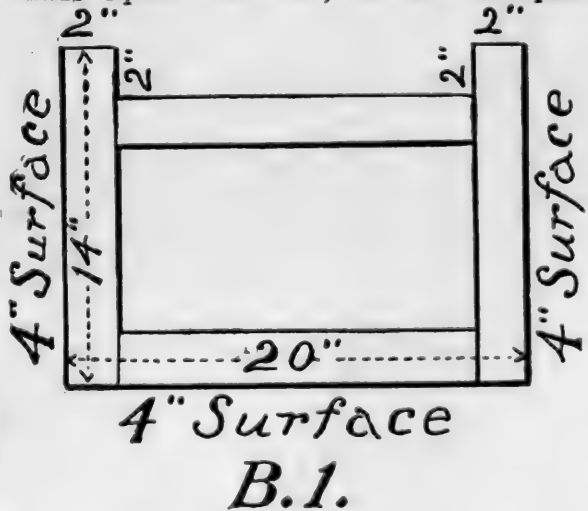

there is in the jointure the better will be the watertight quality of the boat.

Having the floor of the boat thus adjusted place the stanchions on it on their relative positions, B1, B2, etc., and nail them firmly on from the outside of the floor, which can be readily done by driving a few nails to hold the stanchion to the floor and then lifting the entire construction on 2 or 3 horses. The floor transoms, beams or whatever you may term them should be placed so that 1 inch of the width will be on either side of the line corresponding to that stanchion as marked in the diagram.

Nail on the bulwarks, which should be 12 or 14 inches for a 6 foot boat, as deter-



Cross-Section at B.3.

mined by the height of the stanchions in the framework; or, still better, use good screws and countersink the heads a little. If you use nails sink the heads also. After fastening on the bulwarks, or sides of the craft as far forward as B5, go to the stern and nail boards across the stanchion B1 for the stern of the boat; then nail the sternpiece (A) in its place, from the outside of the floor like the stanchions. Clamp and nail the side planks into place on stanchion B6 and the sternpiece. Then paint the seams and nail holes thoroughly inside and out with white lead; or, still better, if you are sufficient of a shipyard mechanic, caulk the seams from the outside with spur-oakum and pitch them well, painting the nail holes with white lead. After they are either leaded or caulked, nail slats over each seam in the sides and bottom and pitch or lead all the joints of the slats. Make a seat 9 inches wide and adjust it on the sunken crosspiece or stanchion B4; also to the sides of the boat. Affix the rowlocks at a convenient distance between stanchions B3 and 4.

Do not bother about fancy rowlocks. Make them out of stout wood and nail them to the side of the boat. Block out the oars and spokeshave off the square part down to the blade. Insert a screw ring into the head of the stem (A) and splice a rope on to it for the painter. Nail fitted boards from stanchion B6 to the stem A, which can be utilized for a seat and which will be found handy for stowing a cable for the anchor, etc., or for bait cans. Screw a few large hooks along the sides of the stanchions to hang fishing rods, &c., on, being careful to file to bluntness the ends of the hooks so they will not pierce your clothing or leg when you are moving about in the boat.

Exercise your joiner ability in making a lid for the 2 stanchions' sunken crosspieces B1, B2, one piece of the lid being one inch from the stern, and to this attach the remainder by a pair of butts. The 2 inch stanchion will then support the lid, which can be used as the stern sheets of the yawl. Nail boards across the forepart of stanchion B2 and you have an admirable locker, which, by means of a staple, hasp and padlock can be made your nautical strong box, as well.

If, after putting the dory in the water, any of the seams leak, persistently pitch or lead them until they are tight. This will be an excellent boat which can be rowed or poled along, and which is good for any purpose except rough water or to ascend a rapid current. This last can be overcome by the navigator's making a towpath out of the bank and a mule out of himself, and hauling on the painter.

By carrying a frying pan in the well (B6 to A) and a little salt and pepper, a few matches and some bacon in the locker, you can fry your fish just after they are caught and thus appreciate, as never before, the delicacy and deliciousness of fresh fish.

In a mackinac not so elaborately constructed as the foregoing I journeyed many hundred miles and shot many a rapid. In the early times of Western settlement *voyageurs* from the upper villages would build large boats of this plan, load them with vegetables, etc., and glide down to the inchoate settlements, where they would sell their truck and, knocking their mackinacs apart, sell the material for lumber.

She—Why did you propose to me the first time you met me?

He—Because I never expected to see you again.—Exchange.

THE TROUBLES OF 2 TENDERFEET.

KLATTOWA.

In the spring of '88 the little town of Conconnelly, then known as Solomon City, well up among the hills between the Methow and Okanogon rivers, in Northern Washington, was enjoying the sensation of a mining, or, more correctly speaking, a prospecting excitement. The camp lay cosily at the head of a little valley, wedged into the narrow coulee out of which tumbles Salmon creek. A short distance below this coulee, where the valley begins to broaden and the sunlight lies on the riffles, a number of us prospectors had set our tents.

Camp life there was chosen by many in preference to such accommodations as the hotels could offer. At that time stumps stood in the street, sidewalks were unknown and landlords showed their guests to bunks in an attic over a barroom where celebrating prospectors and cow chasers were rampant. The camps along the creek were pleasantly located, and the creek supplied us with fish. At almost any time, one could stand on the bank and shoot a salmon that was working its way up through the shallow places. Shooting was the popular way of taking these fish; in fact, the only way we knew. Shooting had but one disadvantage, the plunge, hip deep, into icy water to retrieve.

One day a bright new tent was set up near our own and was occupied by 2 young men. One was a sort of prospector and mineral expert, and the other a newspaper correspondent, both sent out by a Salt Lake syndicate. The new camp was supplied with all modern conveniences, which made our camp look like the deuce of spades in a euchre deck. I consoled myself with the reflection that it is characteristic of tenderfeet to burden themselves with camp equipment and mentally gave old Frank credit for keeping our camp within the limit of sensible appointment.

A few weeks passed. Chaparral and sarvis bushes were bursting into foliage and the great pine tree that stood as a shelter over our tent was taking on a fresher green. Each day someone could be seen, rifle in hand, walking slowly along the bank of the creek looking for salmon; and the odor of fried fish and bacon grease at meal time had become familiar.

Our new friends took no part in this, though making some pretensions to being sportsmen. Indeed, they spoke disparagingly of the practice and said that in time they would show us a 19th century way of killing fish.

Old Frank remarked one morning that

the 19th century way of doing things was surely due.

"Those fellers got an idea that what they don't know they ain't goin' to learn here," he said. "Worst pair of tenderfeet I ever see. Bet if that long pilgrim found a cool cinder he would assay it. I happened 'round just in time t'other day to prevent that 4-eyed idiot from blowin' Mineral hill all over this district. He had pinned a paper target on the powder house and was about to shoot when I happened to see what he was aiming at. He said he didn't s'pose any one would store 2 tons of dynamite in a wooden box like that. I told him people out here didn't s'pose any one would shoot into a wooden box unless they knowed what was in it.

"Tries to make me believe he is an old timer. Saw him trying to get on a Siwash's cayuse t'other day and he couldn't get near enough to reach its neck. Cayuse was on to him in a minit, and I guess he doesn't savee the cayuse yet.

"Know what they did? Some one told 'em that ducks flew from this lake to the upper lakes and they stood there in the coulee with scatter guns till night waitin' for ducks. Don't s'pose a duck ever saw any of these lakes.

"Saw that pinto they had t'other day? He's gone now. Give an Injun \$8 for him. Knowed durn well they couldn't keep him, or the Injun wouldn't have sold him for no \$8. That Siwash camped below Ruby City and knowed that the first time that cayuse got loose he would go that way and stop with his old tillicums. When these fellers offer a reward for their pinto some other Injun will bring it back and in a short time it will be gone agin.

"Don't think they have had fish since they been here. Told 'em to come over once and I would divide with 'em, but they didn't come. Wonder if they thought I would bring it to 'em.

"S'pose you heered about their reception at Wynetchie? The boys over there framed up a gambling row and worked one of these fellows into being stake holder. I think it was the expert. They made out he was in the deal to do a rancher what went against their game. Lights all went out first shot, and there was a stampede to get out. There was hoarse yells and guns cracked and chairs crashed, and the room was full of powder smoke in no time. A saw mill hand fired a wad that missed this feller and hit Sunrise Pete in the gob and nearly put him out. They got the expert

out the back door, where he stumbled over a feller what groaned, 'Oh, God, fellers, I'm all in.' They hid the stake-holder and kept him there by telling him he would be accused of killing that man at the door; the vigilanter would be looking for him, and it wouldn't be wise to show up.

"Next mornin' a feller sauntered down by the creek where the trail crosses on a log. He tacked a card on an old barrel that stood by a bench of brush and sez, 'Now, Dick, I'll count off 30 paces and we'll shoot fer \$1 a shot. He counted about 3 when the barrel rose up, with a man's legs under it, and tipped over, and there was our neighbor, the whole gang howling about him and ready to take what was comin' to 'em."

Soon after the water in the creek became clear the newspaper man was seen on the bank with a whip, slashing at something in the stream. Suddenly the whip was seen to bend to nearly a half circle, then the shimmer of a silken line could be seen running from the end of it to the water. The fellow was fishing and had evidently fastened to a big one. He was a picture of wild excitement. "I've got 'im; got 'im," he cried; "he's a moose!"

The fish was darting here and there, now in deep water, then in shallow, now splashing on the riffles, then doubling on his trail like a hunted whitetail. The bank rose some 6 feet almost straight above the water and how the fish was to be landed was a problem. The newspaper man was looking for a way down the bank when the soft loam gave way and he slipped knee deep into the creek. At the same instant the rod whipped out strait and there was a tremendous splash. He held the rod well up and wound desperately at the crank. A look of disappointment came over his face when he saw only a tuft of gaudy feathers fluttering at the end of his line.

He said not a word, but climbing up the

bank, looked about for his hat. It could not be found. Down stream a light gray object glanced over the riffles. He said he didn't mind losing a hat, but that fish was the biggest thing that ever wore scales, and he regretted that the scales could not show how much it weighed.

He was preparing for another cast when his attention was attracted to a cow that stood with her head in the entrance of his tent. Our friend picked up a club and running up dealt the unsuspecting cow a sound blow and simultaneously gave a war whoop or college yell. The cow started and ran into the tent. There was a bulging on one side, stakes started from the ground, lines snapped and the tent started for the creek. The camp stove rattled and crockery crashed. Our friend caught the trailing lines and digging his heels in the earth kept the cow from going over the bank into the creek.

Assistance arrived and the mess of lines, canvas and cow was untangled. Old Frank remarked that he had seen cattle roped in all sorts of ways, but "never seed a feller rope one with a tent before." He wanted to know "if that wasn't a 19th century stunt." The expert arrived, and as he drew near walked slowly as if he half expected another explosion. He stood like a statue of despair over the scene of disaster. Assaying utensils and materials, photographic apparatus, groceries, tinware and camp stools were badly mixed. He must have known that all he could say would not do justice to the occasion, for all he said was: "That's a d—— pretty mess, now isn't it?"

The sun came up over the Wonaca lake district, peeped into the valley of Solomon creek and lay on the riffles where the camp wedged its self into the hills. One tent was missing from our group. The tenderfeet had taken an early start for Spokane.

"Father," remarked little Johnny Beanpod, as he glanced over his glasses from the perusal of his favorite Boston paper, "you have ever inculcated the principle, in your arduous training of my intellectual being, that males are more punctual in keeping appointments than females."

"Yes, my son."

"Then, father, how can you explain the fact that, in my perusal of the select obituary notices, I find most of them refer to 'the late Mr. So-and-So?'"—Four-Track News.

FROM THE GAME FIELDS.

The man who quits when he gets enough, with plenty of game still in sight, is a real sportsman.

BEARS, WOLVES AND DEER.

When RECREATION reaches me I am not long in getting from it an elaborate mental menu which certainly is a healthier pastime than the reading of novels.

You will remember me by recalling some of the times when, years ago, you occasionally came to Northern Wisconsin and dropped off at Florence to take a tramp somewhere or anywhere with me, in order that we might steal a march on a deer, or hook a few of those 2-pound trout that made some of those Northern streams such charming retreats for us in the long ago.

One of our trips from Florence was to Lake Patten, 15 miles Southwest, where the primitive solitude still reigned, and for the time being we were lords of all we surveyed. Our castle was the Penrose cabin, in a small clearing on the romantic bank of that picturesque lake.

One of my later trips to the same lake was so full of adventure that I am going to tell you about it.

With my 38 caliber rifle I started to the Southwest of the lake, through an old chopping, and was sauntering along leisurely. When about half a mile from the cabin 2 big black objects leaped suddenly from cover and ran in a bee line away from me. They had probably been sitting upright watching my movements as I walked through an old chopping in which were many charred stumps. I saw at a glance that the fugitives were bears, and they must have been so deeply interested in my approach as to forget the danger there is in a gun, for they kept mum until I was so near they could have seen me wink; but then the gap of 3 or 4 rods between us was quickly strung out. It is amusing to see how agile a big, waddling bear can be when he gets scared.

My surprise was even greater than that of the bears. My first impression was that they were 2 big black hogs. This impression was soon dissipated when I realized there were no hogs running wild in that section, and then the idea of bear came to my mind. In an instant I was following them on the run. Though far ahead of me, I could easily keep their trail by the crashing of brush and bumping of logs over which they passed. After following them a hundred yards or more and while passing a pot hole where there was some water and a rank growth of grass, I caught sight of a deer. He was quietly taking observations, and the sight was too tempting to be resisted. I forgot all about the larger game and took a quick shot at the deer, but

missed. He was off in an instant and then I had the country all to myself. You know how it is. When a fellow chases 2 bear a while he gets out of form for shooting at them or anything else.

I tramped on to the South, soon left behind me the old chopping, that was weird and enchanting, passed over a ridge and entered a dense forest of hemlock. Coming to an old logging road, I stopped to look up and down. I could see 200 or 300 yards. Night was approaching, and I knew it was just the time to keep still, to look and to listen.

I stepped to one side of the road and leaned against a tree.

No one who has not experienced the stillness and solitude of a Northern wilderness at sunset can imagine how suspicious and lonely one becomes in the midst of such surroundings. I had stood beside the tree, watched and listened until I had nearly exhausted my patience, when suddenly, a hundred feet away, I saw a large, shaggy animal cross the road, with nose in the air, and as stiff as if pointing game. Behind him came another, and following this one still another, making 3. Then shortly 3 more crossed the road in the same manner, and after a minute or 2 still 3 more followed. Finally the last trio came and passed, making 12 in all.

They were big timber wolves who had passed with military precision before me. Here was one of the strangest maneuvers of wild animals I have ever seen, and it proved to me the sagacity and cunning of the wolf. They were evidently on a hunting expedition. The strongest were in the lead and the leader was the largest and bravest of them all. These characteristics became less and less marked as the tail end of the line appeared and the last 2 or 3 animals seemed to be following along because they had to. The contrast between the 2 ends of the line was singularly striking. The leader, with head aloft, was watching and waiting for some coveted object on which to prey, and he would then give the signal for breaking line of march, when the whole pack would make the forest resound with their inimical yells. A person hearing them would doubtless say there were 100 in the pack. Another striking circumstance about these wolves is the fact that I neither heard them before they approached the road nor after they left it. Neither did I see them before or after, as both sides of the road were thickly grown with brush.

Why did I not shoot? Because I was

too deeply interested in watching and studying the animals. It is not all of hunting to kill game. It is often more fun to study a wild creature's movements than to kill it. To have fired at one of these wolves would have broken up their hunting party in an instant and that would have ended the most interesting show I ever saw.

And now comes the most thrilling episode of that remarkable day's hunt. Immediately after these wolves had crossed the road I heard crashing of brush on the opposite side of the road, and the animal that was making the disturbance was coming directly toward me. At first I thought it was the pack of wolves returning. Then I said "a bear." I shuddered till you could almost have heard me, and looked for limbs on the tree by which I was standing, but there were none.

Finally relief came when close to me, on the opposite side of the road a large porcupine waddled to a tree and clambered up it. I regained my composure in a moment and made strides toward camp, which I reached long after the day had merged into night.

C. O. Coleman, Croton, Ohio.

ONE RAINY MORNING.

F. W. PARKHURST.

Near my home in central New York is a sheet of water termed by courtesy a lake, though covering scarcely 150 acres. It is almost round, and is bordered on one side by a few scraggly hemlocks and by a highway on the other. It affords, in season, excellent duck shooting; and the sport is made more exciting by its risk, for it is an even chance that the shooter will himself stop a stray charge of 4's.

One rainy evening in April, '96, my brother and I wheeled to our little cottage on the shore of the lake and made preparation for the fun we expected in the morning. We awoke at 4 to the music of an alarm clock; soon had a fire burning merrily, and an appetizing breakfast prepared.

At the first peep of dawn we were in our boats and ready for the ducks. The light came fast, and a glimpse of 2 dark shadows on the water working toward a large flock of ducks in the middle of the lake, warned us that we must hasten or lose our share of shooting. It became a race to determine which boat should have first shot. Finding myself handicapped, I compromised with fate and took an advantageous position for a chance when the birds flew. Bang! bang! bang! and fun began. Up went the birds with a sharp swish of wings, headed straight for my boat. I let them come within 30 yards and then sprang up. They

hesitated, turned and were lost, for they received both barrels in rapid succession. Four fell with a resounding splash.

The banging became general and ducks flew in all directions in bunches, pairs and singles, with an occasional large flock. One beauty came flying along at a 60 mile clip, and I drew on him; but a hasty glance beyond convinced me that my place was in the bottom of the boat. I dropped like a log, and just in time, for my neighbor across the way, apparently unconscious of my proximity, let drive with both barrels, and played a merry staccato on the sides of my boat. It was a humiliating position. I rose with offended dignity and poured forth a most convincing presentment of the case; but the man was an old hand and knew a charge of 4's could not hurt much at 100 yards. He calmly remarked, "I hope I didn't hurt you much." I was forced to admit that I was uninjured, and the only reply I received was: "You ought to be thankful for my consideration in allowing you time to drop." I have learned since that the only sure preventive of such accidents is to shoot first.

Shifting my position to a less dangerous neighborhood, I lay back for business. First a pair of teal came swiftly on. When in range the old Wilkesbarre spoke and down went the leader. My second barrel drew a blank. Then birds came so fast I was kept busy attending to them.

It was marvelous how the ducks shifted from one location to another, receiving volley after volley as they swung round the fatal circle. They apparently lost their wits, and if they passed one string of boats in safety, they were sure to fall victims at the next. Frequently 25 or 30 boats dot the lake, so close together that it is a wonder a single duck escapes. I never knew ducks to act elsewhere as they do on this particular lake. I have seen flocks of 30 or more fly round and round until not over 2 or 3 were left alive, and smaller flocks are frequently annihilated. Do not gather the impression that it is pot shooting, for it is not. After the first shot in the water, every bird is killed on the wing.

CAMPING IN THE HILLS.

H. F. HACKETT.

In the spring of '83 Jack Foster, John Dunkin, familiarly called "Dunk," and I concluded to put in a summer in the mountains between Dillon, Montana, and Yellowstone park, so we procured pack and saddle horses, and bought our grub, camp outfit, traps, tent and everything we needed for a 3 months' stay in the hills. Besides, we took along a pick, shovel and gold pan, for we intended to prospect. We took only 2 guns, an old muzzle loading shot gun and

a 45-60 rifle, for we intended to kill only what meat we needed.

We left Dillon April 3, going up Black-tail Deer creek, and by 4 o'clock we were up to the forks, about 25 miles from Dillon. There we found a family of beavers, so we made camp. That night it rained and then snowed and at last cleared, cool and frosty before morning.

The next day we moved camp about 7 miles and left our traps set so one of us had to come back in the morning. We made camp at the mouth of the canyon, on the right fork of the creek. On each side were mountains towering several thousand feet above us. In the morning Jack said he would visit the traps and we could put in the day in the hills. Dunk and I started at sunrise for the top of a high, irregular mountain between the 2 creeks, about 7 miles away. We rode 4 miles and then had to go afoot because of the snow.

Just after we left the horses we saw 3 antelope on a ridge, and crawled up close enough to see that one was a young buck. We had agreed to kill only males, animal or bird. This came within our lines. Dunk made a splendid shot and killed the buck. We dressed it and hung it up, to be picked up on our return. That was before the days of game laws or scarcity of game, so we could kill for our daily meet without fear of game wardens or of being roasted by

RECREATION.
Crossing a deep canyon, over snow which frequently broke through, we climbed a high mountain on whose side we found a bunch of mountain sheep, and from whose summit we had a magnificent view for many miles.

While gazing on the scene we saw, in a deep valley 2,000 feet below us, a silver-tip mother and her cubs, sporting in the sun. It was too far to shoot and too dangerous climbing to go to her, so we left her in safety and ignorance with her children.

Turning about, we sought camp, picking up our antelope on the way. We reached camp tired and hungry, ready for Jack's trout and a sleep.

Jack had caught 3 beavers, and was skinning them when I went to sleep.

The record of the next 90 days, if written, would read much like that of our first in camp, so I need not spin the whole yarn. We had dead loads of fun, plenty of trout, venison and hard work, and returned in the fall with faces like those of the native red man and with muscles like steel.

THE GOBBLING SEASON.

Have you ever been in a good turkey woods in April? Have you ever got up before daylight and started out, after get-

ting a hasty breakfast or cup of coffee, and listened for the first gobbler to commence? Do you know how to imitate the whoop of an owl so as to start something for the gobbler to get mad at? If not, you have missed the grandest sport of all, and have a great deal to live for. Many people, some of whom have hunted turkeys, do not know that the best way to find them in the gobbling season is to imitate the whoop of an owl just at daylight, or to listen first for the whoop of a real owl.

Turkeys sometimes gobble a little earlier in the season, in this section, than April 1st. When the dogwood trees are in blossom, and it is a clear, beautiful morning, you may be sure that if you are within a mile of a gobbler you will hear him. Then comes the most exciting time of turkey hunting. He may answer the call at once, and come within easy range; but you must not get excited and think he is in range before he is, or you will miss the chance. Then again, especially if your call is the least defective, he may be one of the smartest of all wild game, and come only just beyond range. There he may walk up and down and say, "Now you come to me," which is practically an impossibility. The uncertainty is, of course, the interesting part; but I know one place where you can go and feel reasonably certain of getting a shot at a 22 pounder; a place where you can hear over 50 turkeys gobble in one morning; a place where deer are thicker than rabbits, with no scarcity of rabbits; but, of course, you must not shoot a deer or a hen turkey in April, even if I tell you where the place is.

Pax, Memphis, Tenn.

FROM BOSTON, TOO!

Vincenzo Tasanarri, the well known North street merchant, lived up to his reputation with gun and rifle at Milford the other day by shooting 35 squirrels in an hour. This record, it is said, has never been eclipsed among Milford's sharpshooters. All of Mr. Tassanarri's friends are now complimenting him for his prowess with the gun.

This clipping is from the Boston Post. The fellow mentioned lives on North street, Boston. He needs a little advice from you. Am sorry I haven't a picture of him to put with the other hogs in your rack.

Richard D. Jacob, Dorchester, Mass.

In answer to a letter of inquiry, I received the following:

I received your short letter inquiring for a true statement of what you have written and am very glad to say to you that every word of it is true as I am quite a mark at shooting or gunning as I should say, and also am very fond of it, too.

I did not think it would not go outside

of my few friends, but I see and also read about it in the Boston papers.

V. Tasseriani, Boston, Mass.

Your friends who are congratulating you on your beastly, brutal slaughter are as scurvy a lot as you are. If any of them were decent sportsmen, they would tell you to your face how contemptible you are. You ought to be locked up in the cellar of the county jail, instead of being patted on the back. Your number in the game hog book is 1,004.—EDITOR.

ONE ROBIN COST \$95.

Justice M. E. Sell, of Windber, had 3 Italians, Benjamin Benmarte, John Pisoni, and Charles Minote, before him Saturday morning, charged with 3 separate violations of the game laws and with breaking a borough statute.

Constable S. W. McMullen caught the men Friday evening. They had killed a robin and had it with them when arrested. Before the Justice they denied the charges, but having the goods on them, each man was fined \$25 and costs, the whole amounting to about \$95. The defendants were charged with hunting out of season, hunting without a license, as they were unnaturalized foreigners, killing a song bird, and shooting within the borough limits.—Johnstown (Pa.) Tribune.

If the unnaturalized foreigners in Pennsylvania should all learn to read and then put in some time each month reading RECREATION, they would save themselves a lot of money, but as long as they can be induced to pay money into the State Game Protective Fund at the rate of \$25 to \$35 each, and that for killing only one bird to 3 men, it is at least more profitable for the State.—EDITOR.

GAME NOTES.

Answering your inquiry, will say that R. H. Montcastle and I killed 81 quails and 11 doves in one day.

Cary F. Spence, Knoxville, Tenn.

You and your friend killed at least twice as many quails as you should have killed, and I trust that by the time you have read RECREATION a year you will agree with me. The time was when a man might reasonably kill 40 or 50 quails in a day, but that time is long since past, and all good sportsmen are content nowadays to quit when they get 10 to 15 each.

The dove should not be considered a game bird at all and should never be killed. It is protected at all times in many Northern States, and the time will come when all Southern sportsmen will agree with us in this matter.—EDITOR.

I am sending you a copy of the new game law of Georgia. Richmond county is in the van for game protection. I never miss a copy of RECREATION.

A. H. Miesel, Augusta, Ga.

Why don't you and your friends join the

L. A. S.? Then you would be in touch and co-operation with the other sportsmen of your State, and with those of the entire United States. As everyone knows who has investigated, this League is the greatest game protective agency ever organized, and all friends of the cause should be members of it.—EDITOR.

Game is plentiful in this region. Ruffed grouse, prairie chickens, ducks and rabbits are numerous. Quails are increasing and in a few years will afford good sport. Our game laws are being rigidly enforced and many arrests have been made. We have plenty of bass, pickerel, suckers and sunfish in our lakes, and good fishing can be had almost any time. Wolves are numerous, but as a bounty of \$7 has been placed on them, they will no doubt decrease in number. Of fur bearing animals we have coons, muskrats, and mink.

A. E. Flint, Norden, Minn.

You remember the entertainment we prepared for you at the L. A. S. meeting in St. Paul in the shape of a seizure of 11 saddles of venison and over 600 ruffed grouse? Well, the grand jury failed to indict, the first term, but we brought the matter up again and got 2 indictments. Mr. Ertz has just been tried on the first indictment and paid a fine of \$500 in cash. The other indictment still hangs over until next term. Such fines as these will make some of the law breakers think the business is not all profit.

S. F. Fullerton, St. Paul, Minn.

I have always taken RECREATION, and like it ever so much. I like the way you pound the game hogs, and I like the lovely pictures you print. The other day it rained hard and as that is the only time one can kill ducks here on Washoe lake, I thought I would try to get some. I went out with my brother. He killed 3 ducks. I killed 2 at 2 shots with my single barrel gun. I am not yet 10 years old. I used to shoot a Remington rifle when I was only 8, and killed lots of rabbits.

Johnnie Bath, Franktown, Nev.

A neighbor of mine, Tom Boettger, at Callicoon Depot, found a dead carrier pigeon near his barn the 5th of February, 1904. There was an aluminum ring on its leg numbered, N. H., 3,424; also an inscription reading "Patter" or "Potten." The ring will be returned to the owner if he can be found.

Charles St. John, Callicoon Depot, N. Y.

FISH AND FISHING.

ALMANAC FOR SALT WATER FISHERMEN.

The following will be found accurate and valuable for the vicinity of New York City:

Kingfish—Barb, Sea-Mink, Whiting. June to September. Haunts: The surf and deep channels of strong tide streams. Baits: Blood worms, shedder crabs and beach crustaceans. Time and tide: Flood, early morning.

Plaice—Fluke, Turbot, Flounder. May 15 to November 30. Haunts: The surf, mouth of tidal streams. Baits: Shedder crabs, killi-fish, sand laut. Time and tide: Ebb, daytime exclusively.

Spanish mackerel—Haunts: The open sea, July to September. Baits: Menhaden, trolling—metal and cedar squids.

Striped Bass—Rock Fish, Green Head. April to November 30. Haunts: The surf, bays, estuaries and tidal streams. Baits: Blood worms, shedder crabs, Calico crabs, small eels, menhaden. Time and tide. Night, half flood to flood, to half ebb.

The Drums, Red and Black. June to November. Haunts: The surf and mouths of large bays. Bait: Skinner crab. Time and tide: Day, flood.

Blackfish—Tautog, April to November. Haunts: Surf, vicinity of piling and old wrecks in bays. Baits: Sand worm, blood worm, shedder crabs, clams. Time and tide: Daytime, flood.

Lafayette—Spot, Goody, Cape May Goody. August to October. Haunts: Channels of tidal streams. Baits: Shedder crabs, sand worms, clams. Time and Tide: Day and night flood.

Croaker—July to October. Haunts: Deep channels of bays. Baits: Shedder crabs, mussels. Time and tide: Day, flood.

Snapper—Young of Blue Fish. August to November. Haunts: Rivers and all tide ways. Baits: Spearing and menhaden; trolling pearl squid. Time and tide: Day, all tides.

Sheepshead—June to October. Haunts: Surf and bays, vicinity of old wrecks. Baits: Clams, mussels, shedder crabs. Time and tide: Day, flood only.

New England Whiting—Winter Weak-fish, Frost-fish. November to May. Haunts: The surf. Baits: Sand laut, spearing. Time and tide: Night, flood.

Hake—Ling. October to June. Haunts: Open sea surf, large bays. Baits: Clams, mussels, fish. Time and tide: Day and night, flood.

Weak-fish—Squeteague, Squit. June to October. Haunts: Surf, all tideways. Baits: Shedder crabs, surf mullet, menhaden, ledge mussels, sand laut, shrimp. Time and tide: Day and night, flood preferred.

Blue Fish—Horse Mackerel. June to November 1st. Haunts: Surf, open sea and large bays. Baits: Menhaden, surf mullet and trolling squid. Time and tide: Daytime; not affected by tides.

SOME FLY FISHING WRINKLES.

E. E. HICKOK.

In view of the vast amount that has been written about fly fishing, it is surprising to find so few anglers who know even the first principles of the art. While my limited experience does not qualify me as an instructor in expert work, I have found in practice much that is at variance with the books. Many imagine that to practice fly casting one must have expensive tackle and an instructor; also that no fish except trout, bass or salmon will rise to a fly. That is all a mistake. An outlay of \$2 will procure the needful outfit; any one of average intelligence will take a fly as well as or

better than they will take live baits. The art may be practiced in any small lake or stream in the country, wherever the water is not too muddy.

I have often wondered why fish take an artificial fly. The natural answer would be, because of its resemblance to the insects on which the fish is accustomed to feed; and on that theory thousands of patterns have been devised to suit any and all fancies.

Most writers, however, assert that a dozen or so different flies may suit all cases. I think the fish does not take the fly because it thinks it is something good to eat, but because it sees something moving, and wants to know what it is, and it can find out only by taking it in its mouth.

Many advocate the use of colors in the make of flies, from white through pink to red, yellow, blue, purple, green and black. My experience is that what best attracts the fish is the best killer. Therefore, in clear water, on a bright day, I use altogether dark flies, of small size. On a cloudy day, in clear water, a lighter shade, and the same on a clear day in dark water. If both day and water be dark, or if it be nearing dark on a clear day, I use a light colored fly on a larger hook. On clear days a dash of red may prove attractive, but beyond this I have no fancy for colors; nor have I much of an opinion of feathers in the make up of flies, for the reason that they are harder to make, easier to destroy, and no more attractive than those made of hair.

It is in every way desirable that the angler should learn to tie his own flies, as he will find in this much of that anticipatory preparation which is only a slight degree removed from actual participation. I once saw a gentleman stop and pick up a bit of black fur or hair, which had evidently fallen from the fur cloak of some lady. Maybe it was a bit of the tail of a marten, but whatever it was, he put it in his pocket. The proceeding seemed a bit undignified, but by it I recognized him as a brother chip, and I imagined that this little scrap would fill a nook in his tackle box, and at some time or other would be worked up into a fly. In my own box I have wisps of black horse hair, white horse hair, goat hair, dog hair, gray squirrel tail, fox squirrel tail, red cow's hair, a buck tail, a bit of old sisal rope, a bit of tin foil, some quail feathers, blackbird, blue jay, some hackles from the necks of white, red, black and dun roosters, besides other stuff.

A scrap of red flannel, some wax, black thread, white thread and silk, complete the kit. From it I construct some outlandish looking things, but they catch fish.

In making a fly I first attach the gut to the hook with a half hitch and 2 loops of waxed silk, then lay on a bit of hair twice as long as I want the finished fly to be. If I want a body, I use more hair, and double it for the body. The hair is fastened to the hook near the end of the shank with a few loops of the silk, working the hair with the fingers so that it is even around the hook. Then I fold the hair back over the loops already made, and loop it on with the silk, trim off the ends, and it is done. If I want the thing to have wings, I trim them on with the scissors. The softer the hair, the neater the job can be made. This kind of a fly is practically indestructible by fish and will last longer than the gut, while its cost is practically nothing. Of black horse hair, in this manner, I make an imitation house fly, or blue bottle, and I really believe that this kind of a fly is the only one a fish takes that it tries to swallow. I have often seen moths, millers and bugs floating on the water, but never saw a fish take one; but I have laid my fly, unlike anything living, among the insects, and had fish take it.

My partner is a crank, and spends lots of time in making regulation flies, and new patterns of his own devising; but my hair flies do equally as good if not better work.

The books all say, never use any but the best quality of hooks. The hooks I use can be had for 10 cents a hundred, and I have never yet lost a fish by a hook breaking or through any fault of the hook, so I see no use of paying \$1.50 when 10 cents answers the same purpose.

The books say, never buy a cheap rod. That advice is good enough for those who have money to burn; and, of course, a rod that costs \$15 will be more valuable and better cared for than one that can be bought for 60 cents. My partner has one of the latter price which he has used for 3 seasons, being out probably 30 days each season. Time and again has he landed bass of 3 pounds weight with it, and for all that I can see it is as good as at first. After 2 seasons' use he took off all the guides and wrappings, sandpapered off the old varnish, put on new guides and wrappings, and with a double coat of coach varnish made it really better than when new. With it he can cast far and accurately, and land anything he strikes; so what more can be asked of a rod?

The books say, always have your leaders 6 to 8 feet long, and the flies 3 feet apart if using more than one. What's the use? The purpose of the leader is to make the connection between line and fly invisible. To this end many advocate stained leaders, which, really, when seen in the water are as plainly visible as the line; but granting that they are not, surely a fish will not notice the difference when only a 3 foot leader

is used, and if the flies are only a foot apart they will have a better chance of getting a fish than if 3 feet apart. The most important thing in catching fish is first to find the fish. Then the flies should be laid on the water near the fish. If 3 flies of different shades are then near together, it stands to reason that the fish has choice, and may take either of the 3; but if the flies are 3 feet apart only one fly has a chance. True, one of the others may get a fish by being where the fish was not expected to be, but that will be a scratch catch.

The books say that before going fishing one should practice casting on shore without leader or flies, until the art is learned. I do not agree in this, for the difference between casting on land and on water is so great that after learning on land it will be necessary to learn again on water. A dry line will work entirely different from a wet line, and the slight resistance which is made by having the flies attached will entirely change the cast. I'll agree that there need not be any fish in the water cast over, but the water should be there, and all the trimmings. If the learner knows there are no fish where he is casting, it will require more than ordinary perseverance to keep at practice long enough to get the hang of it. My partner was self-taught, and so was I; or rather, we taught each other, one paddling the boat while the other cast, and when one of us caught a fish he lost his turn. Sometimes we changed often, and then again we did not change until both of us were more than willing; but I don't know of any better way to learn, unless some one who knows the art is willing to act as teacher.

If I had to learn over, and by myself, I should take the bank, and selecting a place where there were no bushes or trees, would stand with my right side to the water and draw from the reel about 15 feet of line. Holding the line in my left hand and extending the rod over the water a little back of me, I would bring the point forward 3 or 4 feet and stop with a little bit of a jerk, somewhat like cracking a whip. By so doing the spring of the rod would carry the line forward, so the flies would strike the water at the extreme length of the line, and close to the shore.

I should then let the flies settle in the water while I could count 5, and would then, with my left hand, draw in 3 or 4 feet with a jerky motion.

I should expect a strike, but if I got none, should give a backward swing to the rod rather upward, and stop with a jerk as I did when sending it forward. This motion would send the flies to the full length of the line back of me, but above the water. As I could not look back to tell when the line was fully extended, I should give about the same length of time as it took it to go for-

ward, say while I was counting 2, before I brought it forward again. If I heard a little snap, I should know I was a little too quick, and next cast would allow more time. When I brought the line forward again, I should pay out the surplus line I had drawn in with my left hand, doing so just as the flies had reached the full length, and this would cause them to drop lightly on the water, that is, if I had aimed at a spot about 3 feet beyond where I wanted them to alight.

I should stand in the same spot, and practice this motion maybe a dozen times, or until I could do it to my satisfaction, and should then take a step or 2 forward while the flies settled on the water. This time I should draw more of the line back with the left hand, and as I raised the line for the back cast I should give it out and draw off 3 feet more to give out on the forward cast; and so on, keeping a constant whipping until I got a strike or until I saw a "boil" in the water near where I knew the flies to be. Feeling or seeing this, a slight turn of the wrist would set the hook, and playing and landing would follow. In playing the fish I should not take time to reel the line, but should draw it in with the left hand. After landing the fish I should start with 15 feet, extending the cast as before.

In all casting along shore I should not attempt overhead work; but after I had gone as far as I cared to I should change the rod to my left hand, and with my left side to the water go back over the same ground. All the time I should keep my upper arm close to my side, letting the muscles of the forearm and wrist do all the work. Often the wrist alone will do all that is required, especially in casting under low bushes or overhanging trees where inviting spots are constantly being presented. I have had no experience in casting when wading; it's too mussy to suit me. Casting from a boat is my preference, as I then have a place for the duffle and have nothing to carry. Besides, the fish can be better cared for, and there is usually room for the back cast without the flies alighting in the limbs of trees where they are likely to be lost. Then, too, the flies often snagged under water, and with a boat I can get to them better. It is seldom that 40 feet of line are needed; more fish are caught within 25 feet than over that distance. Still, it is well to be able to cast accurately as far as even 50 or 60 feet.

I recall an incident when my partner and I, at opposite ends of the boat, were both casting, while a third man rowed us slowly about 40 feet from shore.

From a bunch of weeds on the shore there flew out a coot, which, circling round, alighted out in the lake about 60 feet from us. Hurriedly drawing off what we thought

was the right length of line, both of us cast for the bird. My line alighted on its back, the nearest fly 3 feet beyond it. My partner laid his tail fly a few inches in front of it, and, as tail flies will often do, it gave a kind of a turn, so when my companion drew it back, which he did instantly, the hook drew under the coot and caught it by the leg. The bird tried to fly, but could not get start enough to rise; then it dived, but the strain on the leg rolled it over; then it tried to swim, using both legs and wings. That was a pretty hard strain for the 60 cent rod, still it held in good shape; and after 15 minutes my friend landed the coot, to his satisfaction and that of 15 or 20 other anglers, who were looking on.

A useful accomplishment in casting from a boat is to be able to row the boat with one hand while casting with the other, either right or left handed. This can easily be done by using loose oars, a little longer than ordinary, so one can be laid down while a stroke is being made with the other. I say this can be done easily; at least it looks easy when my partner is doing it, but somehow I can't get the exact hang of it. Still, it is a good thing to learn, for sometimes one may wish to go alone in a boat. I am going to learn it, if it takes me all summer.

GREEDY WASHINGTONIANS.

Herewith I enclose clipping from the Shelton Weekly Tribune, about 2 game hogs who wear both bristles and scales.

A. T. P., Shelton, Wash.

O. A. Bailey and W. B. Forbes fished Goldsborough creek last Tuesday making a catch of 118 trout 8 to 18 inches in length. This is the largest catch of the season, and the boys only fished 2 hours.

I wrote these men as follows:

I am informed you and a friend recently caught 118 trout in 2 hours. Will you kindly let me know if the report is correct?

Following is the reply I received:

That is true. O. A. Bailey and I left here at 5 o'clock in the morning, driving 6 miles up Goldsborough creek, there taking a canoe, or dugout, and working our way up stream through dense underbrush which it is impossible to get through any other way. After going up one mile we fished down to where we started from. Only one of us could fish at a time, as there was not room enough to turn our dugout sideways. It took us 2 hours to come down, and we had caught 118 brook trout varying from 10 to 18 inches.

W. D. Forbes, Shelton, Wash.

If it be true that your 118 fish measured 8 to 18 inches in length, we may safely assume that they averaged one pound each in weight or a total of 118 pounds, so that

you deserve a place in the fish hog book and shall have it. Your number is 1,005, and Bailey's is 1,006.—EDITOR.

TOO MANY TROUT.

Your letter of the 19th has been received. The report to which you refer is in the main correct. There were 3 friends with me. We left Chipman July 14th for the Gaspereau river, and began fishing Wednesday morning, July 15th. By Saturday noon, when our team returned for us, we had secured 70 dozen trout. We were fortunate in having a guide who could prepare them for the table, and who also understood curing trout as I never had seen them cured before. I am sure they would keep for weeks. The longest fish we took were about 13 inches; the great bulk of those we kept were probably 10 inches.

Frank Baird, Sussex, N. B.

You say 4 of you caught 70 dozen trout in 3 days. This is an average of 70 trout a day to each man and, as I understand your statement, it is fair to assume that the trout would average $\frac{1}{2}$ pound each or more; so it seems each of you caught over 35 pounds of trout a day for the 3 days. This is clearly excessive and falls little short of slaughter. Any gentleman should be satisfied with 10 pounds of trout a day, no matter how abundant they may be; and the best type of the true sportsman quits when he gets enough, no matter how many fish or how much game may still be in sight.—EDITOR.

TROLLING HOOK.

No. 729,435. Allen H. Smith, Tremont, La.
Filed March 18, 1903. Serial No.
148,387.

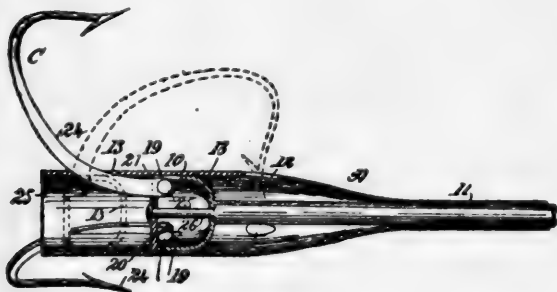

Claim.—The combination with a tubular body having openings therein and slots corresponding to said openings, and a stem mounted to slide in the said tubular body, of a cup secured to the stem and located within the apertured and slotted portion of the body, the said cup being provided with slots at its open end, a cap for the open end of the cup, also secured to the stem and having corresponding slots therein, and

fishhooks the shanks of which pass through the slots in the said tubular body, the inner ends of the shanks being pivoted within the said cup, extending out through the registering slots in the cup and its cap.

NIBBLES.

Do any fishes, when in their native haunts, make guttural noises?

How can one tell the age of muskalonge?

A. W. Gregg, St. Paul, Minn.

ANSWER.

Many fishes give forth grunting sounds. It is impossible to name all that do so. All fishes of the genus *Diabsis*, commonly known as grunts, give forth grunting sounds when taken from the water. Of other fishes that do so, the following are a few: sea robin, *Dactylopterus volitans*; croaker, *Micropogon undulatus*; and drum, *Pogonias*.

No observations have been made on the rate of growth of muskalonge.—EDITOR.

I was much interested in Dr. Adkins' letter in October RECREATION, and I should like to add this. I have fully 20 different kinds of artificial baits, but I have discarded all of them for the Hildebrandt spinner. The spinners will catch bass when everything else fails. I was induced by a friend to try a Hildebrandt. The first day I landed a small mouth bass which weighed nearly 6 pounds, and a number of smaller ones. I ordered one dozen spinners the same evening, and have used them all season, always with success. I heartily recommend them to every angler. RECREATION is the best magazine ever published. It is worth a dollar a copy.

T. R. Navarre, Monroe, Mich.

Trout fishing in the rivers and bass fishing in the lakes in North Idaho was never better than at the present time. Some large catches are being made in the Coeur d' Alene river, where trout thrive.

R. L. Brainard, Wardner, Idaho.

We had good fishing here all last summer and quite a number of large bass and pike were caught.

L. A. Jaeger, Independence, Iowa.

A fishy old fisher named Fischer
Fished fish from the edge of a fissure;

A cod, with a grin,

Pulled the fisherman in—

Now they're fishing the fissure for Fischer.

—Cincinnati Tribune.

GUNS AND AMMUNITION.

Anybody can shoot all day, but a gentleman always quits when he gets enough.

MORO GUNS AND AMMUNITION.

GEO. D. RICE.

Of all the warlike peoples of the Southern seas, the Moro tribes of Mindanao—next to Luzon the largest of the Philippine islands—possess the strangest and most fantastic weapons.

As a member of the punitive expedition under Colonel Baldwin of the 27th Infantry, I had ample opportunity to study the extraordinary equipments of the Moro tribesmen. Numerous murders and depredations committed by Mohammedan natives of the lake country made necessary an invasion of that region. From the beginning of our march from Malabang to the lakes we met with determined opposition. Engagements were of daily occurrence. At Fort Pandapatan and in various subsequent actions we captured the weapons shown in the accompanying cuts.

The pistol is a favorite arm with the Moros. Those used by the Sultans or Dattos are often intrinsically valuable because of their ornamentation, pearls and other gems being used for that purpose. Fig. 1 shows one of these carved pistols of ancient pattern, yet effective at short range. I saw pistols consisting of a mere tube affixed to a wood handle, as in Fig. 2. Only weak ammunition is used, and the missiles employed are ordinarily pebbles, bits of glass, etc.

I saw one gun like that in Fig. 3, in which the cap was exploded by allowing the string of a bow to strike suddenly against the hammer. The idea was doubtless derived from the mediæval bow-gun. Fig. 4 is the most common pattern of Moro gun. It is an old design and made in Spain. The Moros used in almost every engagement a few Remingtons, Mausers, Springfields, Winchesters and now and then a Krag. The chiefs usually have considerable carved work on the stocks of their guns. Fig. 6 shows a favorite style of ornamentation, the stock carved in elaborate floral effects and inlaid with rare gems. Fig. 5 represents one of the powder and ball bags carried by the Moro soldiers.

Sometimes natives in the line are provided only with spears like that in Fig. 6, a bamboo shaft with an old Spanish bayonet attached. In the trenches at Pandapatan many Moros fought with these bayonet-spears.

The Moro is sensitive concerning his knife and is exceedingly proud of that weapon. He spends hours cleaning and

polishing it, an attention he by no means pays to himself. Fig. 7 is a drawing of the sort of knife commonly used in the trenches during the lake campaign. It must be understood that in capturing these Moro

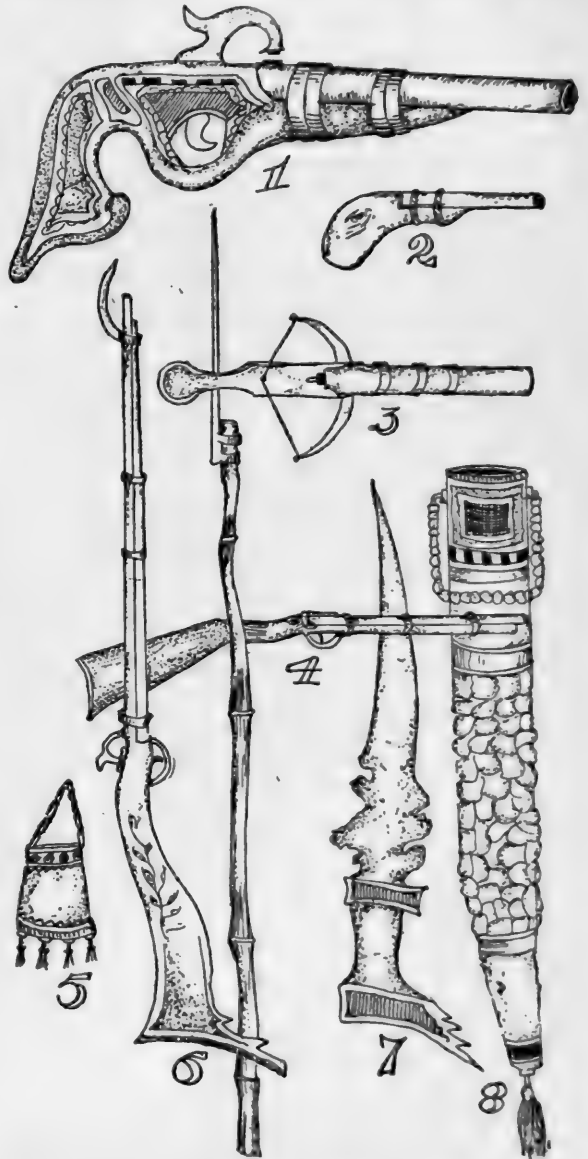

forts, the soldiers first have to destroy the select jurementados who occupy the deep trenches about the fort. They may be few in number, but they have taken oath to die killing the enemy and by so doing obtain assured entrance into the Mohammedan heaven. At Pandapatan, Maciu, and a dozen other engagements, I saw these fellows attack our men hand to hand with knives like that in Fig. 7 and fight to the death. We lost brave officers and men this way. Fig. 8 is one of the shields for this kind of knife.

The Moros call their cannon "lantacars" and one of these, as swung for use just inside the walls of a Moro fort is exhibited in Fig. 9. The Lantacar is of brass or bronze and has a small bore. Usually a round ball of iron or brass is fired. Sometimes, the projectiles are stones, bits of metal, glass and the like. Moro gunners have to swing the point of the gun to get

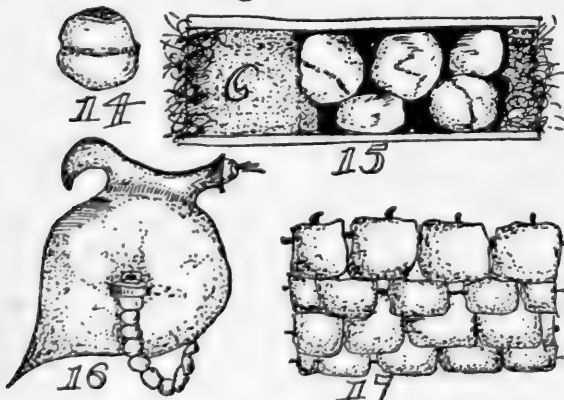
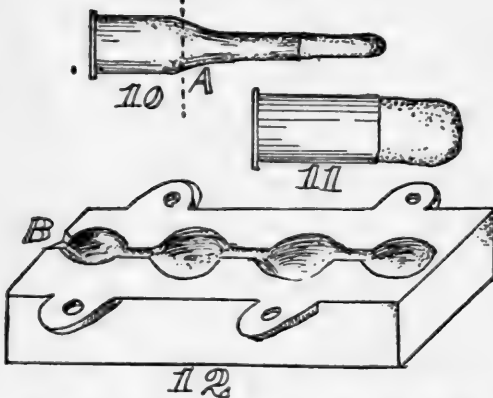
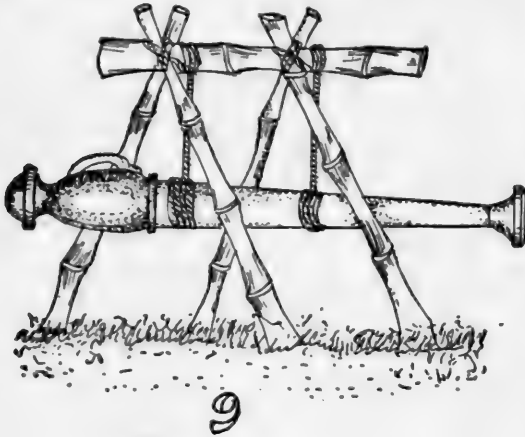

the required aim and steady the arm while it is discharged. The aim is seldom sure, but in every action some one would get hit by discharges from these guns.

The Moros use our shells, Spanish shells and shells of all kinds over and over. Fig. 10 is one of our cartridges. If the Moro finds one too small to fit his piece he winds the cylinder with cordage, and this serves to hold the cartridge in place in his

shot gun barrel. Most of the homemade slugs of the Moro are stubby, as shown in Fig. 11. All are bad things to get hit with. One of the moulds that I found in Fort Binidlan after it was captured is shown in Fig. 12. One of the bronze-like balls cast in it is shown in Fig. 14. There is a prominent ridge about it, where the sides of the mould join. Fig. 15 is one of the tube bamboo ammunition cartridges. The natives use our shrapnel against us in a fight. They did that at Pandapatan and at Poalus. The cut shows the cartridge divided: the powder, held in by grass wads. Then the metal balls are put in, and wadded with grass as shown. This makes the missile ready for use in the lantacar.

The Moros are great on armor. Fig. 16 is one of the styles of metal helmets used by Sultans or Dattos. Wood helmets are also seen. The shoulders, chest and much of the body are protected by armor of deer horn or leather, made by linking pieces, as in Fig. 17. This of course protects only against knives and spears. Chain armor is used, claimed to be bullet proof, though I do not believe it is.

AUTOMATIC GUNMAKERS.

Wherever I have been since October last, I have encountered the man with dog and gun. I bumped up against brother sportsmen until they drove me plumb crazy and until at the first opportunity I, too, slid out for a vacation.

I got mighty few birds, but had a few glorious days out of doors, and, after all, that is the chief pleasure and benefit derived from such trips. Incidentally I tacked up some L. A. S. posters and picked up 2 applications for membership.

Whenever and wherever I meet a man, or a party of men carrying guns and wearing shooting jackets, I proceed at once to get next. I can't help it, I am built that way. We talk about birds, guns and ammunition, each man defending his own preference and possibly all hands getting some benefit from the discussion.

Among other topics, we have talked about the newfangled automatic shot gun. Mechanically, this gun may be a success; commercially, I doubt if it will be. Certainly it ought not to be; and if comments forcibly expressed by numerous sportsmen may be taken as samples of opinion in general the automatic will not be a seller to any great extent. I do not remember having heard anything else so universally condemned, and I have not heard one word in its defense. No real sportsman would be guilty of using such a gun, and its sale or use ought to be prohibited by statute throughout the United States.

I am in the habit of reading RECREATION from cover to cover. It is no disparagement to its other departments for me to say that Guns and Ammunition always interests, frequently instructs, and sometimes amuses me. I have read a number of letters condemning a certain rifle and a certain, or perhaps I should say uncertain, brand of ammunition. If what I have read and heard spoken is true—if half be true—you ought to be glad that these goods are not advertised in RECREATION. You will pardon me if I say that you ought not under any circumstances to publish advertisements of such inferior articles. Readers of RECREATION are, as a rule, gentlemen sportsmen. Should there be any who are not such your aim is to educate them up to that standard, and I contend that the advertisement of an article in RECREATION should be a guarantee of its honest worth and quality.

I have never used either the rifle or the ammunition referred to and, therefore, am not qualified to pass judgment on them. It seems to me, however, that the withdrawal of their ad by the manufacturers was an admission of guilt. If they were the objects of criticism which was unfair and unjust, why did they not put up a defence?

I have been many years engaged in manufacturing. We advertise in trade journals in common with our competitors, and competition is strong. If the style or quality of our goods is criticised do I pout and withdraw my advertisement? Not on your life! I defend my own, which is not only my right but my duty.

This reminds me of the Winchester incident as detailed in RECREATION. At the close of your statement you inquire, "What do the readers of RECREATION think of such business methods?" Answering for myself, and speaking from an experience of more than 30 years, I never saw or heard of anything so silly from a business point of view. It was childishly foolish and petulant; no business about it. I am amazed at such conduct. I cannot comprehend it.

How many people could have followed Dr. Conyngham's suggestions that they "load their own shells"? Not one in a 1,000. Suppose some old time gunsmith should say, in print, "Don't buy factory made rifles or shot guns." I suppose the Winchester people would immediately go out of business. Such action would be in logical sequence to the precedent they established when they withdrew their ad from RECREATION.

There is one thing, however, for which you should give the Winchester people credit. When Mr. Bennett wrote you that the printing of the objectionable 5 lines in Doctor Conyngham's letter, would "work serious detriment to their business," he

paid a magnificent tribute to RECREATION as an advertising medium.

L. A. S., No. 3614, Scranton, Pa.

HIGH POWER RIFLES FOR HUNTING.

In the delightful stories of the woods by J. Fenimore Cooper, there is a world of information of value to anyone who will read between the lines. Nattie Bumpo, the scout and hunter, was a myth; but his favorite rifle, "Killdeer," stood for a type of excellence that had been acknowledged and adopted by men whose names are familiar and whose deeds are part of our country's history. The crafty red man and the wild beasts gradually fell back before these pioneer hunters, such as Kit Carson and Davy Crockett.

In days gone by the settler carried his life in his hand. Examine one of these old pieces, for they are yet to be found in collections. Only recently one was exhibited in the store of a prominent merchant in this city, with bullet pouch, powder horn, charger and bullet mold. The barrel is 33 inches long, the bore about .40 caliber, the bullet spherical. This gun, which came from the West Virginia backwoods, had been in one family several generations, and is now in the hands of a gentleman here who is an enthusiast in protecting game. He says the accurate range of the weapon is about 140 yards, and its penetration at 75 yards about 3 inches of dry pine. This gun was good enough years ago, and now, with no savages in the woods, and few dangerous animals, the hunter of to-day plunges into the forest to slam bang the lead all over the scenery with a murderous high power small bore repeating rifle. It will take years to abate this condition by law, but can not the sportsmen of to-day be brought to their senses before all the game has been killed?

It is certainly time for the floodtide of common sense to set in and show him the error of his ways. Let us stop and think. There is not an animal in the woods East of the Mississippi river that at a distance of 75 yards can not be killed with a 25 caliber rifle. Some may say 75 yards is a short distance. As to this I quote from "The Rifle and Hound in Ceylon," by Sir Samuel Baker, a sportsman known the world over. He says:

"I consider the man a good shot who can bag a deer, running, at 50 yards and standing at 80 yards. Not hit, mind you, but bag."

That is, kill; and this is indeed a conservative statement. It may be truthfully said that there are many 22 caliber rim fire rifles extant which if properly held would conform to the standard of Sir Samuel.

Let us reason together, fellow sportsmen, along the lines of Lord Bacon's famous

suggestion, "Not to doubt or to disbelieve or to dispute, but to weigh and consider." Do we go to the woods for slaughter? I trust not; for there stands the divine command. We go to breathe nature's pure air, to see the delicate tints of the trees, to hear the music of the waters, to sleep sound, to get strong and as appetite comes to kill the venison to satisfy it. Let us leave to the armies the science of the small bore smokeless rifle. It is a soldier's gun and its use in warfare is honorable; but let us get back to the days of our grandfathers and take up once again the single shot sporting rifle, with its black powder and short range. It is the companionship of the woods we want, and not to slaughter the wild animals.

Ex-Ordinance Sergeant, Baltimore, Md.

OFFICIAL CONDEMNATION OF THE AUTOMATIC AND PUMP GUNS.

Dr. Joseph Kalbfus, Secretary of the Pennsylvania State Game Commission, in his annual report to the Board says:

A law should be passed prohibiting the use of the pump gun, and of the automatic gun, recently introduced. Our law forbids the use of the swivel gun, which, in my opinion, is not to be compared for destructiveness with the guns above named, especially on the water, where there is no limit to the kill. These guns are also destructive in the field, for experience teaches that the great majority of men who carry pump guns continue to shoot at flying game long after there is any probability of killing it, frequently after even the possibility is passed. Thus many a bird and animal is seriously wounded; yet, because of distance, is not knocked down and is lost to the hunter. I have a letter from a reliable man hunting in Pike county, who tells of the wounding of 4 deer within half a minute, by a man who carried a Winchester pump gun, loaded with buck shot. A buck, a doe and 2 fawns, came in sight, nearly 100 yards away. The man opened fire, shooting at each one in succession, wounding all, and getting none. This is entirely wrong, and should be prevented by law.

Here is another:

Madison Grant, Secretary of the New York Zoological Society, writes in the society's official bulletin:

A new engine of great destructive power has appeared in the field to aid the forces at work in the extermination of our game. This time it is the birds that are to suffer.

A shot gun which fires, ejects the dead shell and reloads in response to one pull of the trigger has been placed on the market. With it the skilful market hunter can wipe out an entire covey in the same

number of seconds that are now required for the discharge of the right and left.

It may be difficult to prevent by law the use of these new automatic shot guns, although swivels and large bore shot guns have been interdicted in duck shooting, and pitfalls and snares barred in the chase of large game. A public sentiment can be aroused, and decent sportsmen can declare against the use of these new weapons; but only the law can reach the pot hunters.

There is a crumb of comfort, however, in the fact that all these deadly devices in firearms bring rapidly closer the day when this State and all the other States will prohibit the use of lethal weapons, exactly as carrying of pistols, common throughout the country 50 years ago, has been stopped, with the entire approval of the public.

In less than a generation the day will have passed when the American can wander at large over the landscape slaying all living things at will. Then, perhaps, some remnant of our game may be allowed to live in peace.

Mr. Bennett, of the Winchester company, is busy trying to convince the public that my opposition to the automatic and pump guns is due to the fact that he withdrew his ad. from RECREATION.. Has he also withdrawn his ad from the Pennsylvania Game Commission, and from the New York Zoological Society? If not why should these great institutions oppose the use of the slaughter machines?—EDITOR.

THE POWDER HE LIKES.

I have shot over 1,000 Robin Hood shells, loaded with that powder, and have loaded a large number in experimental trials. I greatly prefer the factory loads, however, and especially like the new Comet shell loaded with $3\frac{1}{4}$ drams Robin Hood and $1\frac{1}{4}$ ounces No. $7\frac{1}{2}$ chilled shot. I have tested Comet shells at the trap, and during a duck hunt. It surprised me to be able to kill ducks with No. $7\frac{1}{2}$ shot, that size being considered too small for duck shooting in these parts. I have had not a single misfire with Robin Hood shells, and the execution was all I could wish for.

I killed a prairie chicken last fall at a stepped distance of 90 yards with one of the Comet shells mentioned. Five shot struck the bird and 3 went through it. I admit it was a scratch, for my skill will not enable me to make such shots often, but I afterward tested the gun at 90 steps and it made a pattern that no prairie chicken could fly through and live. I am not bothered much by recoil, for I use a gun pad, but Robin Hood does not make the quick, jarring report of E. C. and L. & R. smokeless. The latter powder disgusted me after making 150 shots with it. I noticed that the L. & R.

powder burnt out through the primers, and I was only using a 24-grain load in the U. M. C. Nitro Club factory-loaded shell.

L. & R. is too tumultuous for me. Robin Hood is clean. It only takes a wipe through the barrel with an oiled rag, and one rub with the Tomlinson cleaner with a drop of oil on it, and the gun is ready to put away. It is quick, and as nearly smokeless as they make bulk smokeless powders. L. & R. is the only true smokeless on the market.

An indication of the vast spread of RECREATION over the United States was called to my attention in a singular manner. Last summer you published a letter written by me in which some mention was made of Robin Hood. Since then I have received many letters from all points of the compass referring to the article and asking, or giving, advice about that powder. The writers of these letters all praised Robin Hood and were unstinted in their admiration of your magazine. I gladly gave the writer of each letter what small information my experience had revealed and it pleased me to know that the brotherhood of the gun is so frank and so ready to help one another.

Referring to duck shooting with small shot: I find, by actual tests, that my 3/4 dram Robin Hood loads will give much better penetration than factory loads of 3 other smokeless powders with Nos. 5 and 6 shot. The latter shells were only 3 dram loads, however, but I should have thought the heavier shot would tend to equalize things, considering No. 7 1/2 shot was used against the larger sizes.

Robin Hood, Topeka, Kan.

HARKING BACK.

I have been using rifles of all kinds and calibers 30 years, on all kinds of game found West of the Mississippi. Probably I have killed enough to warrant the suspicion that there are bristles on my back.

I wish some of the high pressure cranks would explain why they want a gun to shoot 2 or 3 miles after it has passed through the game. Of course they have a better chance to kill an unsuspecting native by shooting a long distance. One says:

"It would not be safe to tackle a grizzly bear with a 30-30." Yet he wants to be classed as a hunter.

Perhaps he is right as far as he is individually concerned; the chances are it would not be safe for him to tackle a grizzly with a 13 inch cannon. I would give up a \$20 gold piece to meet a bear too big for me to tackle with any gun or revolver using even a 44 caliber Winchester cartridge. There should be a law to prohibit the use in any rifle of over 40 grains of black powder, or its smokeless equivalent.

A deer shot through the shoulders, head, heart, or backbone, will go down just as quickly when struck by a 32-20 ball as if struck by the highest pressure gun.

Shot guns are an invention of the devil, and are used by double barrel and pump hogs. Use a 22 rifle and give the game some show. I am surprised that a leader of the L. A. S., like our editor, would publish directions for loading shot gun shells with buckshot. I am not hog enough to murder a deer with a shot gun. Out here we use shot guns and buckshot for road agents.

I hunted deer for market, years ago, using the 44 caliber, '73 model, Winchester and killed more deer than any 2 hunters on the same range using heavy rifles.

Of course readers will say it is all very well for a good rifle shot to favor doing away with shot guns. I will anticipate their saying so and inform them that I have eyes which forever debar me from being an expert shot.

There are 20 makes of rifles more reliable than any man who shoots them; the main point is to know that they will work surely and swiftly.

W. C. Brass, Gold Hill, Ore.

READERS PLEASE ANSWER.

Please give me some information in regard to the comparative merits of the following arms: What are the range and penetration of the 32 caliber Colt single action revolver, using the 32 Winchester smokeless shell?

What is the best length of barrel for general use on targets, to be carried in a holster? How does it compare with the same model in 38-40 and 45 calibers?

Can accurate shooting be done with the 32 at 100 yards?

How does the Colt automatic compare with the above?

What is the best gauge shot gun for all around hunting?

Albert Glenn, Pueblo, Col.

I referred your questions regarding revolver shooting to the Colt people, who reply as follows:

We do not recommend the use of the 32-20 smokeless cartridge in our single action Army revolver, although we know this ammunition is used; therefore, we are not prepared to give the information desired regarding this ammunition. When this style of cartridge is used in this revolver, we advise the 32-20 black powder ammunition. We recommend 5 1/2 inch barrel on the single action Army revolver when it is desired to carry it in holster, also for target work. The 32-20 cartridge has less penetration and range than the 38-40, as the latter is a heavier cartridge,

having 40 grains powder as against 20 grains in the former. Excellent targets have been made with the 32-20 cartridge at 100 yards. This depends, of course, on the ability of the man behind the gun. The cartridges used in our automatic pistols are loaded with smokeless powder, and exceed both in penetration and range, the black powder cartridges named above.

In my judgment there is no shot gun that is suitable for all around shooting. For snipe, quails and shore birds a 16 or 20 gauge gun with 26 inch barrels is right. For prairie chickens, ducks and geese I should use a 12 gauge with 30 inch barrels, weighing $8\frac{1}{2}$ to 9 pounds.—EDITOR.

SMALL SHOT.

I should like to have some accurate data about rifles from any of your readers. I carried a .303 Savage in Canada last year but did not shoot any big game. My companion carried a 33 Winchester with which a caribou was killed with 2 shots. Both bullets went clean through and did not mushroom. These bullets are not so blunt as the ordinary small bore bullets, and I see that the weight is reduced to about 183 grains.

The last cartridges which I got for my Savage were from the Savage Arms company and were said to be loaded with a 190 grain bullet. If this load is right and the charge of powder is heavy enough, it should be better than the 33. This last gun and the 35 Winchester have their reputation to prove. I am a believer in the Savage .303 as against all other American rifles. I do not understand why it is generally classed with the 30-30. It must be a far better killing gun since the bullet weighs .30 per cent. more. It is, however, strange that the penetration should be so nearly the same as given in your table in November RECREATION. Since you speak of a 180 grain bullet I presume you mean Winchester company loaded shells, which are not the same as the Savage.

W. M. E., Baltimore, Md.

Can you tell me how to reload 25-30 rifle shells without a full charge of powder? At present I am using about 8 grains of semi-smokeless, wadded with sawdust to keep the bullet from falling into the shell. Am using an Ideal No. 4 reloading tool.

Louis Lyens, Coldbrook, Ill.

ANSWER.

Good results are not often obtained by filling vacant space in the shell with sawdust. This increases the recoil and sometimes causes fouling difficult to remove. I suggest using some of the new high power rifle shells made by the Winchester Repeating Arms Co. These have a

crease at the base of the bullet, which prevents the bullet from being pushed into the shell. If black powder is used in these shells a wad could be placed over the powder to keep it in the base of the shell in contact with the primer.—EDITOR.

I have taken RECREATION 3 years and am much pleased with the way it handles questions asked by its readers. They are answered better than in any other sportsmen's periodical that I see, and I take 5. Will you or your readers kindly answer the following. Of the Parker, Ithaca, Remington, Baker and Lefever guns, which is the best? Will shot spreaders make a full choked gun equal a cylinder bore for close range wing shooting? Would the use of shot spreaders wear away the choke? Would you choose a 12 or a 16 bore for shooting rabbits and grouse? Which is best at the trap? Would a 12 or a 15 inch beagle be most serviceable to a man hunting rabbits on foot?

Small Game, W. Lebanon, N. H.

Will some of my readers please answer?
—EDITOR.

The gauge, or bore, of shot gun barrels was originally designated by the number of solid spherical lead balls to a pound, one of which would exactly fit the bore. Thus the 12 gauge runs 12 balls to the pound, the 16 gauge 16 to the pound, and so on. Hence the numbers of the different bores run inversely to their diameters. The ball fitting the 12 gauge is .729 inches in diameter, and that fitting the 16 gauge .662 inches. While this system of measurement seems crude and awkward as compared to the caliber measurement of rifle bores, like other archaic systems of weights and measures, long established custom continues its use.—Baker Gun Quarterly.

I have hunted all through Wisconsin, Minnesota, Michigan and Canada and have used all kinds of rifles on deer, bear and moose. At present I am using a .303 Savage. I see some complaints about the stock of this gun being too short; I am over 6 feet tall and a 13 inch stock fits me to perfection. A .303 will stop anything that a 45-90 will and make just as big a hole. Why use such a heavy caliber as 35 when a .303 will do the work? My favorite shot gun is an Ithaca hammerless.

G. E. Van Alstine, Rockford, Ill.

I wish some of your good wing shots would give me a few pointers on holding on chickens and grouse in their different lines of flight. Where can I get a good book on dog training?

J. E. Bates, Spokane, Wash.

NATURAL HISTORY.

When a bird or a wild animal is killed, that is the end of it. If photographed, it may still live and its educational and scientific value is multiplied indefinitely.

A BIRD LOVER IN THE NORTHWEST.

It was with a feeling of deep pleasure that I learned of an unexpected opportunity to go up into Minnesota for 2 weeks in July. In my bow and arrow days I had lived in the Land of the Blue Waters, and among the most treasured of all those early recollections was that of a multitude of birds which in its valleys and on its hillsides live and move and play their little drama anew each recurring season.

Mid-July is a hard time for the birds of the Mississippi valley. A large majority of those whose singing enlivened May and June have folded up their music and retired without responding to the encore we were so glad to give. Only a few hardy singers, members of the finch family chiefly, seem able to resist the shimmering, all pervading heat. As I lie in the woods among the stalks of fragrant pennyroyal and watch the branches and tree tops above for bird life I consider myself lucky if I can catch glimpses of any besides the petulant pewee and the aggressive blue jay.

The splendid Pioneer Limited put me down at a junction in Wabasha county, Minnesota, about 5 o'clock one gray morning at the beginning of dog days. Noon of the following day found me 40 miles West, in the valley of the Zumbro river. Zumbro! What a boom and a roar the old Indian name has; like the voice of its own waters in flood time.

Once in the valley it was evident what a difference 3 or 4 degrees of latitude make with our feathered friends. Back in Ohio a few soloists are still giving us bits of music, reveries and nocturnes principally, but they lack the thrill and fire of the bridal choruses of spring. Here in the valley the whole chorus, from treble of indigo bunting to bass of His Highness, the owl, is still in full song without a quaver or a listless note to indicate the approaching end of the season's revel. Spring has elbowed midsummer out of the way and come back to give us a taste of the days when the cup of the senses is filled to the brim.

In the thickets of willow, box elder, and scrub oak, that clothe the lower, middle, and upper slopes of the Zumbro hills, there is every opportunity for the birds to enjoy life. Fertile bottom lands with their rank growth of weeds breed worms and larvæ in profusion; red raspberry bushes a few yards higher on the hillside furnish the best of fruit; while shade and water are to

be had for the asking. From the bird student's standpoint there is a marked and acceptable difference between these haunts and those of the Maumee or the Central Mississippi valley, namely, the accessibility of the birds. To be sure, these Minnesota woods look scrawny and stubby to a man from the forests of elm or cypress, but here comes in what Emerson calls the law of compensation. Where trees are short there need be no straining or twisting of the neck to distinguish the hues of a *Helminthophila* or a *Dendroica* 80 or 100 feet above one's head.

Down near the water the catbirds were especially numerous. Sometimes as many as 4 were in sight at once on the telegraph wires; while others, hidden in the foliage, told of their presence in no uncertain way. A catbird, like a woman, can be charming when he tries, but when he chooses to scold he is a most uninteresting creature. In the Ozarks, in the Cumberlands, on the prairies of Illinois and along the historic Maumee, I had often observed *Galeoscoptes carolinensis*, but in none of these sections have I found them so conspicuous either for numbers or music as in Southern Minnesota.

Our little friend of the Ohio berry fields, the indigo bunting, was also much in evidence. Instead of taking the dark, leafy recesses or the telegraph wires, like the catbird, he chooses for his perch the topmost twig. There he sits and swings, piping to himself in the manner of a person well satisfied with himself and the world. His wife dresses plainly; dull brown with a wash of blue seems to be the brightest she can afford. At any rate, he puts on the style for the whole family. I doubt not that in the nice economy of Nature things are evened; that the male gets his bright suit to compensate him for some serious lack, perhaps some stratum of improvidence or thoughtlessness in his make-up.

One Sunday afternoon found me wandering up the valley of the most interesting tributary of the Zumbro, an ice-cold trout stream only a mile long, yet large and powerful enough to run a mill. Alternating stretches of pasture and woodland, of noisy shallows and quiet pools, make it an ideal place for our feathered friends. The birds and the brook were such good company that the afternoon was almost gone before I realized it was time to start back if I expected any supper that evening. Suddenly there fell on my ear the note of the

bunting. I looked about and finally located him in the top of a scrub oak. Below him, 6 or 8 feet, sat a scarlet tanager, as brilliant as black and scarlet could make him, in his bower of dark green. Talk of the bright colored birds of the tropics! Whoever saw, even in the forests of Honduras, a more brilliant combination of vivid colors than this of blue, black, and scarlet, set off against the green of the oak. A few rods past this tree I heard the old familiar chirp that greeted my ears on my rambles in Central Illinois, and there flew out of a bushy hawk, straight to the top wire of the fence in front, a rose breasted grosbeak, an exponent of the beauty of the milder hues of rose, white, and black.

Minnesota birds are not color demonstrators only; they sing with the best of any latitude. The evening before I left the Zumbro valley I was sitting on the upper verandah of the hotel, reading letters and looking over my notes for the day, when in the woods across the river, without announcement or prelude, a wood thrush began to sing. After a few of bars of purest fluting he ceased. A moment's hush, and then, a quarter of a mile up the stream, came a response, in tones as pure and liquid as his own. Soon a third joined in, and for the next half hour of that brilliant Northern twilight the concert continued. May be it was a contest. If it was, those birds were on a higher plane than human beings at such times, for through it all there was not one harsh note of envy or jealousy to mar the perfect expression of full veined, midsummer life in the North. Who knows but what these birds were holding a round table conference or something of that sort and were telling one another the superior advantages of Minnesota as a health resort? As the orange and red faded out of the West, to be replaced by waves of crimson and purple, and finally passed into the soft grey of early night, the trio lapsed into reveries; at last in one particularly rich chorus, in which all 3 participated, the music ended for the night.

James S. Compton, Hazel Green, Ky.

A SPRING TRIP TO PUSLINCH LAKE.

In this locality Puslinch lake is the only body of water of any extent. It is 10 miles from the city, and is about a mile and a half long by a mile wide.

The depth, counting only water, is about 6 to 15 feet; but counting mud, apparently 4 to 5 miles. The district surrounding Puslinch lake has by far the richest fauna and flora of any place in this locality, and many are the visits I pay to this delightful spot.

April 30th of last year the air was full of the revivifying influence of spring, the tender green was showing on the black

willow and trembling aspen, and the leaves of the red berried elder were well expanded, Five thirty a. m. found me mounting my wheel with a day's provisions in my fish basket, which serves me as a provision bag, specimen case, egg box, and vasculum, and which also serves to get me into many an argument with the ultra religious when carried Sundays. These same individuals often seem much disappointed when I show them the contents and they find I am not breaking the laws of the land.

When out on such a morning as this, one feels great compassion for people who prefer to snore between the sheets until the freshness of the day has worn off. As I wheel along, bird notes from all sides proclaim the identity of their owners. From every hand comes the carol of the robin, always the first musician of the morning; from the fields the clear whistle of the meadow lark, the sweet song of the vesper sparrow, on this occasion singing matins; the peculiar little ditty of the Savanna sparrow, with its grasshopper-like ending; and from the plowed land the notes of the prairie horned lark, which resemble the squeak of an unoiled caster.

As I pass a piece of damp woodland the minor whistle of the white throated sparrow, the fine music of the winter wren, the exquisite melody of the Wilson's thrush, and the song of the ruby crowned kinglet, so powerful for the size of the bird, sound through the clear air. All these I recognize; but a new note strikes my ear, a sound like the sharpening of a fine saw. I am off in a twinkling, not even waiting for the wheel to lose its momentum, and entering the bush quickly but quietly I behold the first warbler of the season, the black and white. He is creeping up the trunk of a white elm, picking out insects and their eggs from the crevices of the bark, and between every mouthful or 2 uttering his sharp "cee-sweee-cee-sweee-cee-sweee." To the first appearance of anything for the season, great interest is always attached, but in the case of the first warbler this interest is augmented by the fact that for the next month our woods will be gay with the brilliant songs and bright plumages of these beautiful migrants.

While watching this black and white warbler I hear another song, that of the black throated green warbler; a song distinct from that of any other bird, hard to describe, difficult to imitate, but once heard always recognized. After renewing my acquaintance with this latter warbler, I mount and proceed, but while crossing the bridge over the river Speed, a fresh bird voice causes another hasty dismount, and I enter the thicket bordering the river to have a look at the water thrush, which has just arrived from the South. Up on a

branch of a dead cedar he sits and gives vent to his hurried "Witch-chew-chack-chack-chew," of which the 4 middle notes are emphasized.

On I go again and from many of the woods passed come the songs of their new arrivals mingled with those of the musicians who have preceded them by some time; and as an accompaniment the ruffed grouse sounds his drum, a piece of instrumental music without which our spring orchestra would be incomplete.

When near the lake I leave the road and ride down a cow track to the shore. Out on the lake are flocks of American golden-eyes, and lesser scaup ducks. I *cache* the wheel and start on a tramp around the lake, which, on account of bogs reaching in from it, is a distance of some 7 miles. Passing through a piece of rich woodland I find the large white trillium just coming into bloom, the graceful bells of the yellow adder's tongue hanging from their semi transparent stalks, which rise here and there from the dense bed of blotched leaves. The Canada violet is much in evidence here, its large white petals tinged, in a varying degree in different specimens, with purple. The spring beauty, purple trillium, early meadow rue, small flowered crowfoot, and downy yellow violet are here also. As I cross an open, swampy piece of land I pass over many beautiful clumps of the common blue violet; and entering a thin pine wood on the South bank I find one of the hepaticas (*H. triloba*) in full flower. The ground for some distance is covered with magnificent blossoms, in all shades of mauve, blue and pink. In the thicket around the edge of the lake the shadbush is most attractive in its clothing of white blossoms, and the fly honeysuckle hangs out its pale yellow bells, 2 to a stalk.

When I reach the West end of the lake I conclude it is about dinner time. While I am supplying fuel to the fire of life a swamp sparrow hops, twig by twig, to the top of a dogwood bush (*C. stolonifera*) and delivers his liquid, thrilling "twee-twee-twee."

Resuming my tramp I pass through a bog where I find the leatherleaf in bloom, and entering the white pine forest at the other side I notice the delicate white flowers of the goldthread showing among its 3-cleft shining leaves.

After having circumambulated the lake, I regain my wheel and proceed homeward, listening to the evening songs of the birds.

A. B. Klugh, Guelph, Ont.

WHAT THE BIRDS DO.

It has been said that a bird would eat 25 insects a day, which is a low estimate.

There are 170,000,000 acres in Texas, and allowing one bird to every acre, and 25 insects to every bird we find 4,250,000,000 insects, or 35,500 bushels are eaten by birds every day. Persons who study birds have killed different kinds to see how much they eat. In the crop of a quail 101 potato bugs were found. In another quail were 500 chinch bugs. In a yellow billed cuckoo, at 6 o'clock in the morning, 43 tent caterpillars were found. In another, were 217 web worms.

In a robin were found 175 caterpillars; in 4 chickadees 1,028 eggs of the canker worm. One chickadee eats 5,000 eggs of the canker worm in one day.

The barn swallow eats 5,000 to 10,000 flies and other insects in a week. The dove eats 7,500 weed seeds in a week. Nearly all birds, especially hawks, eat locusts. There are 73 species of hawks, of which only 6 are injurious to man. The cranes, herons and bitterns feed on crawfish.

Birds carry food to their young, whose mouths are always ready. One family of jays ate one half million caterpillars a season.

Someone caught a young robin, to see how much it would eat, and said its hunger was not satisfied with less than 60 earth worms a day. One man watched a wren and he said it fed its young 110 insects in 1½ hours.

Near the nest of a martin was found a quart of wings of the cucumber beetle. This shows what a great number of beetles were destroyed. Chipping sparrows each eat 200 worms a day.

Near the nest of a horned owl were found the remains of 113 house rats, which the owl had killed that season. The barn owls destroy meadow mice, which are extremely destructive to young fruit trees.

If every man and boy who shoots would read this and consider the good the birds do, I am sure there would be much less thoughtless killing of the innocent birds.

Hattie Hill, La Porte, Texas.

DEER DO SHED THEIR HORNS.

In RECREATION I have read accounts of deer shedding their horns and I recently noticed pictures of a head with antlers measuring 9 feet 3 inches from tip to tip across the skull, spread 53¼, beam lengths 55 and 56½ inches. I have also seen in RECREATION photos of some larger antlers. Will you settle an argument on this subject? If a deer sheds his horns in, say February, and has 9 months to produce a pair as large as those shown in RECREATION, what causes them to grow so fast? Some say they do not shed every year. Is it true that a buck is a year old before he gets a spike; then in 2 years he gets a prong, sheds

it in February and in 9 months he has a set of horns with 3 prongs.

J. H. Berry, L. A. S. 4451, Newberry, Pa.

ANSWER.

The antlers you saw illustrated and described in RECREATION are not those of a deer, strictly speaking, but of an elk. It is difficult to answer your question as to what makes horns grow so fast, but they do all the same. If you cut off a horse's tail, close to the bone, it will grow out again to the length of 3 feet within 2 or 3 months. The same law of nature which causes the hair to grow so fast as this causes elk horns and deer horns to grow to their full length in 7 or 8 months. The same law of nature that regulates these growths on animals causes a corn stalk to grow to the height of 6 to 12 feet in 3 months.

The men who say deer, elk and moose do not shed their horns every year do not know what they are talking about. If you will go in any zoological garden in January and again in February, you will find that probably all the deer and elk there have dropped their horns. If you go there again in April and May you will see new horns in course of growth with velvet or short hair all over them. Undoubtedly some of your people visit New York occasionally, and it would be well to ask them to go to the Bronx Zoological Park and examine the deer and elk, so they can report to you personally.—EDITOR.

WHO CAN NAME IT?

The other day, at noon, I noticed a strange bird light in a tree, and stopped to watch it. What most attracted my attention was the brilliant reddish purple color under the wings, conspicuous while the bird was flying. It was exactly the shape of a dove. The breast and under part of the body were a shade lighter than those of the dove. On the sides and thighs were a few bars of black, and the upper parts of the wings were black penciled. I should have thought it a young dove had it not been for the red under the wings. It had the same alert, quick motions as the dove when disturbed. Though it kept bobbing its head and acting as if it intended to fly, it allowed me to approach within 15 feet. When it flew, it alighted again in the same tree, and began cooing like a dove, but lower in tone and not so clear. It was evidently a grown bird, but was only about 2-3 the size of a dove. Will some reader of RECREATION tell me what it was?

J. E. P., Round Rock, Tex.

NATURAL HISTORY NOTES.

Some 4 years ago Mr. Cuppy, of Avoca, Iowa, owned a beautiful herd of deer, num-

bering over 20. During the summer they escaped and since that time have been at large. It is a pretty sight to see them in the pastures and fields. Since they escaped from confinement the herd has largely increased. Efforts will be made this winter to recapture them.

One morning last July a resident of Avoca on going into his yard in the morning found the ground under a tree literally covered with dead sparrows. Some of them were still hanging in the branches of the tree. During the night there had been a heavy rain with some lightning. There were 150 dead birds under the tree. What killed them? There were no wires near the tree, and the tree was uninjured either by wind or lightning. I shall be glad to hear some explanation from readers of RECREATION.

Dr. Chas. W. Hardman, Laton, Cal.

A family of wrens built their nest and reared their young in a ball of manila binder twine suspended by a wire from the rafters in an old workshop on our place last summer. It formed a snug home, and the paternal pair would vigorously resent any intrusion on what they considered their lawful domain. A pair of wrens were also observed inspecting the inside of a wooden pump, in search of a suitable nesting site. Their attempt at home making was baffled by the frequent use made of the pump. Several pairs of wrens occupied houses put up for that purpose.

H. H. Birkeland, Roland, Ia.

In September RECREATION there is an article on the fish hawk which says that a family consists of 3 birds, 2 males and one female. Do you know this to be a fact? I have consulted 2 or 3 local ornithologists and they all question the statement. I can find no mention of this habit in either Coues, Chapman or Samuels.

The Natural History department of your magazine is exceedingly interesting. I wish you could have more in it on bird life.

Arthur R. Hanks, Needham, Mass.

Will readers of RECREATION please answer?—EDITOR.

The Women's Club of the 6th district of Iowa in convention here, passed resolutions and signed a pledge never to wear any millinery or hats trimmed with birds, or feathers from song birds or sea gulls.

J. E. Fleener, Oskaloosa, Ia.

This is Congressman Lacey's district, and Oskaloosa is his home. Who says a prophet is without honor in his own country?—EDITOR.

THE LEAGUE OF AMERICAN SPORTSMEN.

GENERAL OFFICERS

President, G. O. Shields, 23 W. 24th St., New York.

1st Vice-President, E. T. Seton, 80 West 40th St., New York.

2d Vice-President, W. T. Hornaday, 2969 Decatur Ave., Bedford Park, N. Y.

3d Vice-President, Dr. T. S. Palmer, Dept. of Agriculture, Washington, D. C.

4th Vice-President, A. A. Anderson, 80 West 40th St., New York.

5th Vice-President, Hon. W. A. Richards, General Land Office, Washington, D. C.

Secretary, A. F. Rice, 155 Pennington Ave., Passaic, N. J.

Treasurer, Austin Corbin, of the Corbin Banking Co., 192 Broadway, New York.

Massachusetts.

Maryland.

Michigan.

Montana.

Minnesota.

New Mexico.

New Jersey.

Oregon.

Ohio.

Oklahoma.

Pennsylvania.

Virginia.

Washington.

Wisconsin.

Wyoming.

This indicates a growing feeling of confidence in the League on the part of the various State Governments which is extremely gratifying to all League workers.

The officers and delegates all gave complete, comprehensive and encouraging reports of the progress of the game, fish and forest protection work in their respective states, which will be published in succeeding issues of RECREATION.

The following resolution was offered by Vice-President Hornaday:

Whereas, The records of the Chief Wardens of the League of American Sportsmen show an alarming increase in the killing of song and insectivorous birds, for food purposes, by Italian laborers and other unnaturalized foreign born persons seeking a livelihood in the United States; now, therefore,

Resolved, That all officers and members of the League, and all State Game Wardens of the United States, be hereby warned of the urgent necessity of a vigilant, vigorous, and continuous warfare against the entire class of offenders named above. And, further,

Resolved, That all State Legislatures be and they are hereby urged to enact and incorporate in their game laws the section of the Pennsylvania law which prohibits hunting by unnaturalized foreign born persons without first having taken out a license costing \$10 a year.

Mr. Hornaday moved the adoption of this resolution, and Mr. Wright, of New Jersey, seconded the motion, whereupon same was unanimously adopted.

Chief Warden W. A. Gleason offered the following resolution:

Whereas, There is now pending before the Legislature of the State of Iowa a measure having for its object the prohibition of spring shooting on ducks and other aquatic fowls; and,

Whereas, The State of Iowa is directly in the line of flight of ducks and other

PROCEEDINGS OF THE 6TH ANNUAL MEETING OF THE LEAGUE.

The 6th annual meeting of the League of American Sportsmen was held at Columbus, Ohio, February 10 and 11, 1904, the following officers and delegates being present:

W. T. Hornaday, Vice President, New York.
 Dr. T. S. Palmer, " " Washington, D. C.
 A. F. Rice, Secretary, New Jersey.
 J. J. Hildebrandt, Chief Warden, Indiana Division.
 J. E. Tylor, Chief Warden, Maryland Division.
 W. E. Gleason, Chief Warden, Ohio Division.
 J. C. Porterfield, Delegate, Ohio Division.
 Geo. Lilienthal, Delegate, Zanesville.
 C. F. Emerson, Chief Warden, Pennsylvania Division.
 G. H. Pond, Delegate, Pa.
 Dr. Jos. Kalbfus, Delegate, Pa.
 B. S. White, Chief Warden, W. Va. Division.
 Hon. M. A. Bates, Delegate, Idaho Division.
 W. Van Iorns, " " "
 Ernest Russell, Delegate, Massachusetts Division.
 Hon. C. E. Brewster, Delegate, Michigan "
 Hon. Sam Fullerton, Delegate, Minnesota "
 Hon. H. G. Smith, " " "
 Hon. H. A. Morgan, " " "
 August Reese, Delegate, Missouri "
 T. F. Dawson, Delegate, Montana "
 Hon. W. F. Scott, Delegate, " "
 F. C. Wright, Delegate, New Jersey "
 C. A. Cooper, Delegate, Oklahoma "
 Hon. J. W. Baker, Delegate, Oregon "
 T. Gilbert Pearson, Delegate, North Carolina "
 Capt. L. L. Goodrich, Delegate, Texas "
 Hon. L. T. Christian, Delegate, Virginia "
 Hon. T. P. Kershaw, Delegate, Washington "
 Valentine Raeth, Delegate, Wisconsin "
 R. B. Watrous, Delegate, " "
 Wm. Benton, Delegate, Wyoming "

In addition to these, about 80 local members attended the meeting.

The Governors of the following States appointed delegates to this, the sixth, meeting:

Alaska.
 California.
 Connecticut.
 Indiana.
 Illinois.

water fowls in passing from their winter home to their nesting grounds in the North; and,

Whereas, Said State of Iowa is traversed by many important streams, rivers and water courses in which the ducks and other aquatic fowls stop to feed and rest in their Northern flight, thereby inviting their wholesale destruction; and,

Whereas, It is the common judgment of all thoughtful men that spring shooting should be universally prohibited; therefore,

Resolved, By the League of American Sportsmen, in National Convention assembled, at Columbus, Ohio, on the 10th day of February, 1904, that it is the earnest desire of the League that said measure should be immediately enacted into law. And further

Resolved, That we respectfully urge the Legislature of said State of Iowa to pass said bill. And further

Resolved, That duly authenticated copies of this resolution be forwarded to the presiding officers of both branches of the Legislature of the State of Iowa.

Mr. Porterfield moved the adoption of the foregoing and Mr. Morgan, of Minnesota, seconded the motion. Unanimously adopted.

Mr. Tylor, of Maryland, offered the following which, on motion duly seconded, was unanimously adopted:

Whereas, Governor Myron T. Herrick, of the State of Ohio, Mayor Jeffrey, of Columbus, the press of the city, the members of the Ohio Fish and Game Commission, the Ohio officers of the L. A. S., and the Olentangy club have shown the visiting delegates to the 6th annual convention of the League every courtesy, every consideration, every welcome, together with a special entertainment and banquet, thereby contributing greatly to the pleasure and interest of the convention; therefore be it

Resolved, That the League of American Sportsmen, in annual meeting assembled, hereby expresses its hearty appreciation of all these courtesies, together with the expressions of good-will and encouragement which have so materially assisted in making this meeting so entertaining, so pleasing, and so eminently successful.

Mr. Sam Fullerton, of Minnesota, offered the following resolution, and moved its adoption:

Resolved, That the League of American Sportsmen, in annual meeting assembled, at Columbus, Ohio, desires to go on record as emphatically and unalterably opposed to spring shooting of all kinds of game, because we deem it a crime against the laws of nature to kill any bird or animal in the mating season; and further, because game killed in spring is unfit for food and should not be eaten.

Dr. T. S. Palmer moved the adoption of the resolution, and it was thereupon unanimously adopted.

Mr. W. E. Gleason offered the following resolution and moved its adoption:

Whereas, The present laws for the protection of fish, game and insectivorous birds in the State of Ohio are in a measure inconsistent and easily evaded; and,

Whereas, The Ohio State Fish and Game Commission has prepared a bill to create a fish and game commission, prescribing its duties and powers, providing for the protection, preservation and propagation of fish and game in the State of Ohio, and for the enforcement of the provisions of said act, and prescribing proper penalties for violations thereof; and,

Whereas, Said bill has been introduced in the Legislature of the State of Ohio, therefore,

Resolved, By the League of American Sportsmen, in convention assembled, that in our judgment the enactment of said bill into law would place the State of Ohio in the foremost rank in the matter of game and fish protection, and the Legislature of the State of Ohio is hereby petitioned to enact said bill into law.

Senator H. A. Morgan, of Minnesota, moved the adoption of the resolution, and this motion was seconded by W. T. Hornaday, whereupon the same was unanimously adopted.

Dr. T. S. Palmer offered the following resolution, which, on motion of Mr. Hornaday, seconded by Mr. Rice, was unanimously adopted.

Resolved, That section 4 of Article 4 of the constitution be, and the same is hereby, amended to read as follows:

The annual meeting of the League shall be held at such place and on such date as the executive committee may determine.

Mr. B. S. White offered the following: Whereas, The cities of Seattle, Wash., Portland, Oregon, St. Louis, Milwaukee and Oklahoma have, through their representatives in this meeting, extended to this League most cordial and courteous invitations to us to hold our 7th annual meeting within their respective cities, therefore,

Resolved, That the officers and delegates here convened do express to the people of these several cities and States our hearty appreciation of the hospitality thus offered, and we regret our inability to accept all of these invitations. We hereby express the hope that in succeeding years we may have the pleasure of holding meetings in each of the cities who have thus honored us.

Mr. C. H. Pond moved the adoption of this resolution, and Mr. T. G. Pearson seconded the motion, whereupon it was unanimously adopted.

Mr. A. C. Cooper, of Oklahoma, offered the following resolution and moved its adoption:

Whereas, The Hon. John F. Lacey has introduced in Congress a bill known as House Bill 11,584, and entitled "A Bill for the Protection of Wild Animals and Birds in the Wichita Forest Reserve," which bill authorizes the President of the United States to designate such areas in said forest reserve as should, in his opinion, be set aside for the protection of game animals and birds for a breeding place therefor, and that when such areas shall have been designated, all hunting, trapping, killing or capturing of game animals and birds within such areas shall be prohibited; therefore,

Resolved, That the League of American Sportsmen, in annual meeting assembled, does hereby endorse and approve the said bill, and does hereby urge and implore the Congress of the United States to pass said bill at the earliest possible date.

Mr. Ernest Russell seconded the resolution and the same was unanimously adopted.

A banquet was tendered the visiting officers and delegates, by the officers and members of the Ohio Division, which was attended by 140 men, including the Governor of the State, a number of members of the Ohio Legislature, and the Mayor of the city of Columbus.

Governor Herrick and Mayor Jeffries delivered eloquent addresses in which they welcomed the visitors to Columbus on behalf of the people of the State and of the city, and tendered us every courtesy at their disposal.

The dinner was thoroughly enjoyed by all present, and addresses were made by several members of the Legislature and by other prominent citizens, as well as by League officers and delegates.

ANNUAL REPORT OF THE PRESIDENT.

The League of American Sportsmen was organized in February, 1898, with 147 members. To-day it has 9,815 members, distributed throughout all the States and Territories of the Union and all the Provinces of Canada. We have also members in Mexico, in Cuba, in Porto Rico and in the Philippine islands.

The past year has been one of the most eventful in the history of this great body. We have made substantial gains in membership, in State organizations and in the work of securing good game laws for the various States. In no single year of our existence have we made more gratifying progress in this last named work than during 1903. A brief resumé of our work on these lines must certainly prove of deep interest to all League members and all other friends of game protection.

Montana, Idaho, Wyoming, Oregon, Minnesota, Illinois, Tennessee, Virginia and Texas have completely reconstructed their game laws. Some of these States have repealed existing statutes for the protection of game and of song birds, and have enacted completely new codes from beginning to end, built on thoroughly modern lines. New York has lined up with Vermont, New Hampshire, Ohio, Michigan, Wisconsin, Minnesota, Utah, Alaska, Manitoba, Ontario, New Brunswick, and Newfoundland in prohibiting spring shooting of wild fowl.

Nebraska, Texas and Idaho have passed the League bill to prohibit the killing of antelope at any time, thus leaving Colorado, Wyoming and Washington as the only States in which any antelope are to be found and which have an open season on these animals. Arkansas now prohibits the sale of game of all kinds; Illinois that of wild fowl; Washington that of rail and plover, and of water fowl with certain restrictions. New York has prohibited the sale of ruffed grouse and woodcock killed within the State.

Texas and Arkansas have cut off the export of wild fowl, and Indiana, Montana and Texas have established additional restriction on the export of game.

Illinois, Indiana, Montana, Tennessee, North Carolina and New Hampshire have passed laws requiring non-resident hunters to take out licenses, and Arkansas now denies non-residents the privilege of hunting there at any time. Several States have fixed limitations to the number of birds and animals that may be killed in a day or a season, and others have materially reduced the bag limit.

Virginia has for years had on its statute books a so-called game law, but its provisions varied as to the different counties in the State, so that scarcely any 2 counties had identical game laws. Many counties were excepted entirely from all provisions of the general State law, and so had no restrictions against the killing of game of any kind. During the past winter the Hon. L. T. Christian, a member of the Virginia Senate and a member of this League, prepared a modern, up-to-date game law, introduced it in the Senate and pushed it through both Houses. It was approved by the Governor, and so the Old Dominion now has as good a game law as those of most of the other States.

The members of this League may well feel proud of the result of their year's work in the securing of good laws. The sweeping changes and improvements in these State laws are wholly due to the educational work carried on by the League, the Audubon Societies and the American Ornithologists' Union. The same great wave of public sentiment on behalf of the wild

life of this country, which has enabled us to secure the enactment of so many good laws in so many States, greatly aids us in enforcing these laws.

I believe it is possible for us so to strengthen this public sentiment, this wholesome respect for game, fish and forest laws and this interest in the preservation of all wild life, that violations of such laws will practically cease. We have an immense amount of work to do before we can bring about this condition, but we are doing it every day; and the number of people who favor good game protective laws, and who respect them when enacted, is growing more rapidly than most people are aware of.

Sometimes when we learn of large numbers of depredations against game and fish laws in various parts of the country we are led to fear that in time all the wild animals and birds will be swept off the continent, except such as may be confined in private or State preserves. On the other hand when the mails and the daily papers bring us glowing reports from every corner of the land as to the thousands of people who are daily becoming interested in our work, we are inspired to hope and to believe that we shall be able in time to exterminate the game and fish destroyers, and to leave to posterity a country inhabited by millions of wild animals and birds.

The membership of this League does not grow so fast as it should, but it grows. In my last annual report I told you we had 9,210 members. To-day we have 9,947 members, a gain of 737 during the year 1903.

A year ago we had 45 State divisions. To-day we have 48.

A year ago we had 54 local chapters, and we have organized 9 since. At the last annual meeting I reported 176 local wardens commissioned and in the field. We have appointed 12 since then, making a total of 188.

A year ago we had 35 life members. We have enrolled 4 during the past year, so that we now have 39.

From these figures it will be seen that the wheels of progress still move, and as we grow stronger they will move more rapidly.

For several years we kept an accurate account of the number of prosecutions and convictions of law breakers, in which League members were directly or wholly concerned. I am glad to be able to tell you that during the last year our members were more active on these lines than ever before, and it is no exaggeration to say that during 1903 members of this League prosecuted and secured the conviction of over 600 men for violating game, fish or forest laws. The value of this work is simply beyond computation. We all know

that when a man in any town or village or farming community is convicted or fined for violating a game or a fish law every man and woman within 20 miles of him hears of it. More fear of and respect for the law is inspired by one conviction than by all the reasoning and preaching that could be done in a month. A burnt child dreads the fire, and when one gets burned the others learn to dread the fire, also.

Even the Indians of the far West have learned that game laws are dangerous things to tamper with, and there have been fewer instances of wholesale killing of big game by Indians in the past year than in any previous year since the first game laws were made.

I reported last year the sending out of a circular letter to wealthy men, asking for contributions to the game protective fund of the League. As a result we collected \$770. A second appeal was sent to these same men, and to many others during 1903, but I regret to say the responses were not so generous. About \$460 has been collected thus far, as a result of this second request. This is no doubt due largely to the shrinkage in stock values last fall.

The distribution of printed matter from the general office of the League has gone on during the year as regularly and as extensively as heretofore. Our cloth posters, offering a reward of \$10 for each conviction of a violation of a game or fish law, are still being distributed wherever we can find men willing to put them up, and many thousands of them have gone out during the year. The daily newspapers are giving more and more attention to the League every year, and most of them have now learned that this organization is the source from which nearly all the practical and aggressive game protective work of this country emanates. A single quotation from the Tacoma, Washington, Ledger will serve to illustrate the general trend of newspaper comment on our work:

"A game bill has passed both houses of the Legislature that is believed to be as nearly perfect as it is possible to make a game law. It was prepared by the League of American Sportsmen; and F. A. Pontius, of Seattle, Secretary-Treasurer of the Washington Division of that body, has been at the capital during the entire session working for the passage of this bill. Chief Warden F. S. Merrill, of Spokane, and H. Reif, of Seattle, also a League member, have worked diligently with Mr. Pontius for the passage of the measure, and the League is entitled to all the credit for having secured the passage of this law."

The work carried on by the League and kindred societies has practically abolished the millinery traffic in bird skins. There are few women in this country to-day who

have the courage to decorate their head-gear with the skin of a song or an insectivorous bird. A few of them still wear gulls, terns, owls or other birds on their hats, but even this number is decreasing, and I believe that in another year all bird skins will have so completely gone out of fashion that a woman would as soon think of being seen in public with the skin of a fish tacked on her hat as that of a bird.

Many of the local chapters of the League are doing effective work in their respective localities, independent of and auxiliary to that of the parent organization. These chapters hold regular meetings, enact their own by-laws, get out their own posters, which are distributed in common with ours, maintain special wardens to patrol the surrounding country, and in this way have a marked influence on would-be law breakers.

A number of gun clubs have been organized in the United States within the past year, which provide in their by-laws that no man who is not a member of the L. A. S. is eligible to membership in such gun clubs.

The United States Fish Commission and the various State Fish Commissions have long since recognized the League as an institution which should be rewarded in their work. Several local chapters have made applications to their State Fish Commissions for small fry for stocking local waters, and all such have been promptly granted; while many of those sent in by individuals have not been filled for lack of the necessary supply.

For instance, Local Warden A. C. Cooper, of Fort Sill, Oklahoma, applied to the United States Fish Commission for 28,000 crappies, and the request was promptly granted. The fish were shipped to Fort Sill and planted in a local stream. Every angler in that section of country appreciates the good work thus done by the Fort Sill Chapter, and in consequence most of the sportsmen in that region are members of the League.

As an instance of the energy and persistence with which certain members go after law breakers, I quote from the report of Local Warden Isaiah Vosburg, of Saranac Lake, New York:

August 26th, Willard J. Jessup, New York City, fined \$85 and costs.

August 29th, J. D. Alexander, Tupper Lake, N. Y., fined \$100 and costs.

October 3d, Elmer Barton, Westville Center, N. Y., fined \$200 and costs.

October 11th, John Soper, Malone, N. Y., fined \$100 and costs.

The Georgia Legislature, at its past session, enacted an up-to-date game, fish and bird law. Governor Terrell at first declined to approve it, because of a provision therein that the complaining witness in

cases of violation might receive one-half the fines collected.

On learning of the Governor's objection to the bill, I immediately wrote a personal letter to each member of the League in Georgia, asking him to take up the matter with the Governor and to urge him to approve the bill. Our Georgia members acted promptly on this suggestion. Not only did they write and telegraph the Governor themselves, but each man induced many other sportsmen to do so. As a result the Governor promptly approved the bill. So Georgia is in line with a good game, fish and bird law.

There are so-called sportsmen, in nearly all the States, who for various reasons are fighting this League. They are advising their friends not to join it; or if already members, to withdraw from it and to connect themselves with certain local game protective organizations. The League has no desire to compete with any local body working along the same lines. On the other hand it is our aim to co-operate with all such; and by reason of our broader and more general field of work and of our great influence with law makers and with the public at large, we can be of great benefit to the cause in any locality, as well as in the country at large. It is, therefore, a source of keen regret that any man should deem it necessary to oppose this League in its great philanthropic work. Each member of the League should make it a part of his duty to explain to all such misguided men the error of their ways, and to induce them not only to cease their opposition, but to join the League and to work with it.

The President also regrets that independent game and fish protective clubs are occasionally being organized, that should instead be local chapters of this League. As such they could do their local work more effectively than they can possibly do it as independent bodies. At the same time they would be a part of this great National League, would have the advantage of its power and its prestige, and would serve to make it still stronger and greater.

The great need of the League is a larger membership and a larger working fund. Let every member make it his business during the next year to make better known the principles and precepts of this great organization, and to do everything in its power to build up its membership and thus increase its usefulness.

Little Amzi (who has an inquiring mind)
—Uncle Timrod, what's a bonanza?

Farmer Neckwhiskers (painfully experienced)—A bonanza, durn it, is a hole in the ground, owned by a liar! That's what a bonanza is!—Exchange.

FORESTRY.

It takes 30 years to grow a tree and 30 minutes to cut it down and destroy it.

METHODS OF SILVICULTURE.

That part of the forester's business which concerns itself with the reproduction of the harvested crop is called silviculture or forest culture. This reproduction can be secured in various ways. The simplest, easiest, surest and, in the end, probably the cheapest way, is that which the farmer uses with his crops: harvest the ripe crop and sow or plant the new crop. The Germans, having for more than 100 years fooled around with other, the so-called natural regeneration methods, have come to the conclusion that after all this simple, if artificial, method is in most cases the best. The main objection raised against it is that it is more expensive, but of late it has been found that in the long run it turns out the other way. Nevertheless, it must be considered, first, that the majority of mankind does not appreciate the long run; and second, that as in the paying of taxes, we are all willing enough to be mulcted indirectly, while we object to paying directly. If we plant or sow, there is a definite direct outlay of \$5 or \$10, or \$15 an acre; if we secure a new crop by natural regeneration, we do not know that we have paid for it in increased logging expenses, in waste of space and time. It is only the next harvester who finds out that it would have been better for the result if direct tax had been paid instead of indirect.

The natural regeneration of a wood crop presupposes the existence of a forest which it is worth while to reproduce. Of course, only the kind of trees which are already present can be so reproduced, by the seeds falling from them, or by the sprouts issuing from the stumps of the cut trees.

The capacity for reproduction by sprouts is possessed by all deciduous trees, the so called hardwoods. The conifers, with the exception of the redwood, practically do not possess this capacity. Hence, the most important species, which furnish $\frac{3}{4}$ of our lumber consumption, can not be reproduced in this way. Moreover, the sprouts from the stump, or stool shoots, while growing much more rapidly at first than trees grown from seed, stop growing sooner; they do not make lumber trees, but only sizes fit for telegraph poles, railroad ties, fence material and firewood. The stumps are apt to rot and, unless new blood comes in naturally or is secured by the forester, the coppice, as such sproutlands are called, gradually deteriorates.

For the farmer's wood lot, which is for other reasons fit only to produce firewood and small dimensions, this coppice system

has many advantages and is mostly the one to develop. By cutting the stumps low, with a smooth, slanting cut, he can make them last longer and produce better sprouts, cutting the crop every 20 or 30 years, replanting where stumps die out, and, by cutting the less desirable kinds in the sap, thus killing them out, he can gradually improve the composition of his crop.

For timber purposes, only trees grown from seed will answer. In the so called natural regeneration, the philosophy is that the seeds falling from the trees which are standing on the ground or in the neighborhood, will sprout and grow into new trees when the old trees are removed. This is Nature's way of maintaining and perpetuating the forest. The difference between Nature and the silviculturist is, that Nature does not care which trees reproduce themselves nor how slowly or quickly or usefully the new crop grows; while the silviculturist makes distinction between tree weeds and useful species, which he favors, and which he wishes to have develop as rapidly and as satisfactorily in form as possible. Where it happens that only one, and that a useful species, covers the ground exclusively, or nearly so, as for instance in the pineries of the South, such reproduction is readily secured. Two conditions only are necessary to start the new crop, namely, that just before cutting the old crop a seed year occur, as trees mostly bear seed only periodically; and that the soil be receptive, namely, in such condition that the seed falling to the ground can germinate. After the young seedlings are established, a further condition must be secured, namely, enough and not too much light for their development. This is secured by the gradual removal of the old trees. Various species require different degrees of light or shade, hence the removal of the shade must be more or less rapid. According to the manner and rapidity of removing the mother trees the silviculturist recognizes different methods by different names; as the strip system, when a narrow strip is cut and the seeding comes from the marginal timber; the group system, when smaller or larger openings are made here and there for new groups of young crop to develop; the nurse tree system, which is the best, when seed trees are left in even distribution over the whole area and are gradually removed as light is needed by the young crop; and finally the poorest, the selection system.

This last is similar to the method of our lumberman in the mixed forest when he

culls the stoutest trees here and there, as they are or become merchantable, leaving Nature to fill the openings thus made with young growth and the young crop to develop as best it can. The silviculturist proposes to introduce the following improvements on this rough method, which in the lumberman's hands is not even intended to secure a new crop. If, as is usual, tree weeds occur mixed with valuable kinds, it is proper first to get rid of them, so they will not reproduce in preference to the valuable trees. If the market does not warrant cutting out the tree weeds, they may be girdled and killed. This is a dangerous proceeding, to be sure on account of possible fires. Where the good kinds are poorly represented, it is necessary to leave seed trees even though they are merchantable. Finally, not to leave the development of the young crop entirely to the haphazard of Nature, removal of old trees, at the proper time for the sake of benefiting the young crop, may become necessary, because otherwise the young trees may again die out. In addition, it may be desirable to scratch the ground so as to secure a good seed bed. The absence of young spruces in our wild woods is often due to the absence of a good seed bed. This system, which in Germany is practiced on less than 10 per cent of its forest area, here and there in small patches, is, as anyone can see, least certain of results. Only in game preserves, where the main object is not wood production, or in Alpine regions, where protection of soil and water conditions requires a continuous forest cover, interrupted as little as possible, is this system to be recommended; and wherever better methods can not be introduced on account of the unwillingness of the owner to submit to direct taxation for the benefit of the future. To reduce the cutting in the virgin woods to a given diameter is not silviculture, but a financial proposition and a device to save something for the future. By not culling all of a given valuable species, the possibility is at least kept open of reproducing that species by natural regeneration later, if there be any virtue in such natural regeneration.

Where the lumberman has culled out all that is valuable, but valuable species are still sufficiently represented in the remaining growth so that seed may be produced by them, it may under some circumstances be possible to recuperate the slash by cleaning up and subduing the weed trees and brush weeds; but in most cases the only rational way to treat such slashes, if timber production is the purpose, is to clear, by fire if need be, and plant. The clearing need not be thorough or complete, but it will only rarely be an advantage to leave any of the existing growth.

In restocking such areas, as well as aban-

doned pastures and fields, planting is preferable to sowing in most cases, unless seed can be had cheap and a seed bed can be secured readily. Proper planting is more successful and cheaper, because the plants can be nursed through the first 2 or 3 years of their delicate seedling life. At least, with conifers, which are almost exclusively to be considered in lumber production, this is the preferable method.

The plants should rarely be more than 3 years old, grown in nurseries, and should be set out at the rate of 1,500 to 2,500 an acre, according to soil and species. By choosing a proper mixture of species better progress of the plantation can be effected, as well as a considerable cheapening of the planting cost, which at present prices, when growing one's own plant material, can be kept considerably below \$10 an acre.

There is, of course, no *finesse*, no manuring, no cultivation practicable. After the plantation is set out, or possibly after replanting the first year's losses if in excess of 20 per cent, the plantation must be left to its fate, except to protect it against fire and possibly against insects. When it is 20 or 25 years old, hardly before, it may become desirable to thin out the dead and dying material. By that time it should be a thicket of slender poles with the branches in the interior dead and mostly broken off. Up to that time the object was to force the height growth by preventing as much as possible branch growth, and crowding the trees to reach upward for light; also to kill off the lower branches in order to secure clear shafts. When this has been accomplished, sooner or later, according to species, soil, climate and other conditions, working for diameter begins. This is secured by judicious thinnings, repeated every 5 or 10 years as the case may be, giving to a selected number, the final harvest crop, 200 more or less to the acre, special chance for development by cutting away those which interfere. These selected ones will then grow rapidly in diameter and by the 60th or 70th year will be fit for sawlogs, while without such treatment 100 to 120 years may be consumed to secure satisfactory sizes.

The realization that to secure inferior materials not less than 20 to 30 years must elapse, that to grow saw timber 60 to 80 years and more are required, breeds the natural desire to manage the virgin woods so as to lengthen out their supplies and to secure by conservative lumbering our present needs without curtailing the future over much.

"You doubtless expect to marry for love?"

"Oh, now and then!" exclaimed the young girl, romantically.—Life.

PURE AND IMPURE FOODS.

Edited by C. F. LANGWORTHY, PH.D.

Author of "On Citraconic, Itaconic and Mesaconic Acids," "Fish as Food," etc.

"What a Man Eats He Is."

PEACHES IN COLD CLIMATES.

Though peach trees will stand quite severe winters, late spring frosts are fatal to a crop. The flower buds open in the warm sunshine of early spring, only to be killed by the frost which in colder regions is almost sure to follow.

Various devices have been tried to prevent early flowering or to protect the trees until danger is past. Peach growing from a commercial standpoint in Colorado is largely confined to the Western slope of the mountains where conditions are favorable. The trees find a congenial home in many localities in several counties, consequently large areas are devoted to the cultivation of this fruit. In the Eastern part of the State the crop was almost always ruined by spring frosts although the tree grew well. In 1896, some experiments were begun in the protection of trees which were so successful that the method followed is now practised on a large scale. This consists in laying down the trees and covering the tops. The process is described in a recent bulletin of the Colorado Experiment Station, in effect as follows:

As soon as the trees have shed their leaves and the wood is well ripened, they are ready for winter quarters. This is usually in the early part of November. The first step in the operation consists in removing the earth from a circle about 4 feet in diameter about the tree. When sufficient trees have been treated in this manner to make the work progress advantageously, water is turned into the hollows. After the ground has become saturated, the trees are worked back and forth and the water follows the roots, loosening the soil around them so they are pushed over in the direction that offers the least resistance. When treated in this manner the trees go over easily and with comparatively little injury to the root system, providing they have been laid down each year. It is difficult to handle old trees in this manner, if they have never been laid down and usually it will not pay to try.

After the trees are on the ground, further work should be delayed until the ground has dried sufficiently to admit of ease in the handling of the dirt. The limbs may then be brought together with a cord and so lessen the work of covering.

After experimenting with many kinds of coverings, burlap held in place with earth

has proved the most satisfactory. The burlap is spread out over the prostrate tree top, taking special pains to protect the blossom buds from coming in direct contact with the earth covering. A light layer of earth is then thrown over the tree and the protection is complete.

The critical time in growing peaches by this method is in the spring when growing weather begins. Close watch must be kept to see that the blossoms do not open prematurely, or that the branch buds are not forced into tender white growth. When the blossom buds begin to open, the covering should be loosened so as to admit light and air, but it should not all be removed. More of the covering should be removed as the weather gets warmer, but the blossoms must be exposed to the sun gradually.

Air and light are, of course, necessary for proper fertilization of the flowers, but after this process is complete and the fruit is set, all danger from the weather is considered over. The trees are usually raised about the middle of May.

Raising the trees is, of course, a simple task. The ground is again watered and when wet enough the trees are raised. To be sure, trees that have been treated in this manner will not usually stand upright unsupported. Consequently, they are propped up at an angle, usually 2 props being required to keep the wind from swaying them.

When this method of growing peaches was first presented before the Colorado State Horticultural Society, it was received with not a little sarcasm by some of the members, but the practicability of laying down the trees is now no longer questioned. The constantly increasing acreage of peaches proves that it pays. The actual expense is, of course, difficult to estimate, because of the attention required in the spring. The cost of the fall work can be estimated, however, as it has been found that 2 men will lay down and cover 25 of the largest trees in a day.

This process seems to be in no way detrimental to the health of the trees, since they live as long and bear as much fruit according to the size of the top as those grown in peach sections. It is, of course, necessary to cut out the wide spreading branches and thus reduce the size of the top in order to lessen the work of covering.

SUBSTITUTES FOR TEA.

Many substitutes for tea can be found in any ordinary woods. The idea is not a new one, for many country folks made use of the substitutes in the days when the luxury of Chinese tea was not so easily afforded as now. Before the Revolution when the colonists were in a turmoil over the stamp taxes, it was considered unpatriotic to drink tea that had paid tribute to the government, and the so-called Liberty tea was the popular drink.

The four leaved, loose strife was, no doubt, the herb from which this beverage was made, possibly with the aid of various other herbs. It is common to almost every woodland.

In some districts of the Southern United States, pennyroyal tea is a common beverage and seems to take the place of real tea.

The leaves of the New Jersey tea, a low bush which grows everywhere in dry woodlands, and bears in June and July a profusion of delicate white blooms, were also extensively used during the Revolution. An infusion of the leaves has a bright amber color, and in looks is as attractive as the real beverage; but the taste, though astringent, is by no means lively. Some effort has recently been made in commercial circles to revive the use of this plant as a substitute for tea. The leaves are said to contain about 10 per cent. of tannin.

Hemlock leaves and those of the arbor vitae have played an important part in the making of rustic tea. The arbor vitae is a tree that grows wild in great abundance in Northern woods, and the old time Maine lumbermen used frequently to resort to its leaves for tea when other herbage failed them for the purpose. It is thought to be invigorating.

The leaves of the wintergreen, a small plant, whose bright red berries, about the size of peas, are sold on the streets under the name of teaberry, have long been used for tea. The foliage is aromatic, and people who like a dash of spiciness in their drink have sometimes added its flavor to real tea. It is near of kin and similar in taste to the creeping snow berry, a small, delicate vine, abundant in the great bogs and mossy woods of the North and Alleghany regions, and this is also approved by mountain palates as a substitute for tea. Thoreau, in "The Maine Woods," tells of his Indian guide bringing it into camp one night and recommending it as the best of all substitutes for tea. "It has a slight checkerberry flavor," Thoreau records, "and we agreed that it was better than the black tea we had brought. We thought it a discovery and that it might be dried and sold in the shops."

Better known as a tea plant is the Labrador tea, *Ledum latifolia*, which grows in cold bogs and mountain woods from Penn-

sylvania Northward. The leaves, which emit a slight, not unpleasant fragrance when bruised, are tough and leathery, and covered with a rusty brown wool. Steeped, they give a wild, gamy flavor to hot water, and the drink resulting suggests a poor grade of black tea.

Sweet fern which is such an abundant growth everywhere on sterile hillside and by mountain roads, is another famous tea plant often known as "mountain tea." During the War of the Rebellion its use for tea was particularly prevalent in the Southern States, and many a Southern lady who was reared in luxury was reduced to drinking this poor substitute for her favorite Oolong or flowery Pekoe.

The foliage and flowers of all the golden-rods contain an astringent principle, and are moderately stimulating so that their suitability for the manufacture of a domestic tea was recognized by the American colonists as long ago as when George III. was king over them. One species, the fragrant leaved goldenrod, known sometimes as Blue Mountain tea, possesses, in addition, the flavor of licorice. Drunk piping hot in the wilderness, it makes a pleasant feature in the camper's limited menu. This especial kind of goldenrod begins to bloom early in the summer and is easy of recognition, even by the non-botanical, because of the licorice perfume which the leaves give out when rubbed. It is a common species in the pine barrens of New Jersey. The astringent quality, in a greater or less degree, is possessed by nearly all these plants. They also contain considerable tannic acid. These 2 properties go far to make tea the popular beverage it is.

As an ardent admirer of RECREATION, permit me to compliment you on the November issue and to join with you in the hope that we shall see the day when the game hog will be consigned to utter oblivion. Your war is as righteous as the Crusades, and you may well realize that you have the support of every true sportsman.

Bronte A. Reynolds, Englewood, Ill.

"The reason I can't get along with my wife is that she wants to submit all our differences to arbitration."

"To arbitration?"

"Yes. She always wants to refer disputes to her mother."—Four-Track News.

I have bought your magazine from my newsdealer 2 years, and find it deeply interesting. The way you handle pot hunters and game hogs is refreshing. Let the good work go on.

W. C. Musser, Yeagertown, Pa.

PUBLISHER'S NOTES.

NEW STYLES OF MARBLE KNIVES.

The illustrations herewith show Marble's 6-inch Ideal hunting knife in 3 styles, blade Nos. 1, 2 and 3. The blade as at present made is a modification of the 2 shapes of blades formerly made, known as sticking and skinning points, and is claimed by many expert hunters and woodsmen to combine more of the essential qualities for all-around use than are usually found in one style knife.

The new blades are slightly thinner than the old pattern, and carry a more gradual bevel back of the edge. The bone chopper at back of point is a valuable feature for rough work.

The solid hard rubber handle, No. 3, is considered by some superior to any other

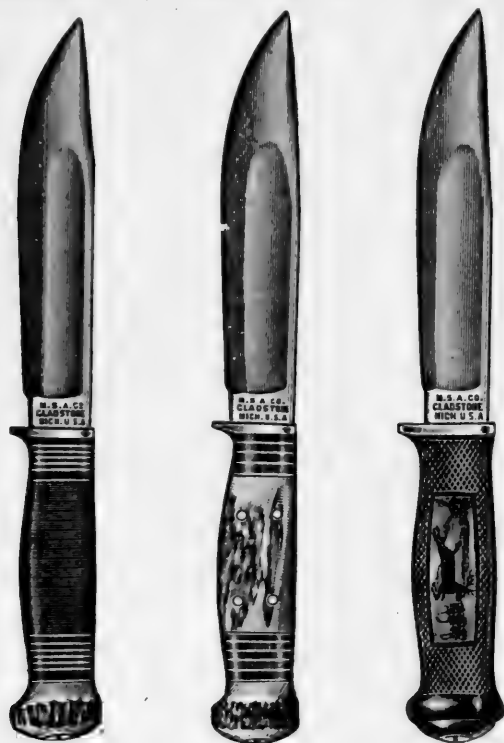

No. 1

No. 2

No. 3

material for the purpose. The heavy tang, threaded at the end, just fits the mortise in handle, and a half inch brass nut countersunk in end of handle, engaging with threaded tang, makes the strongest fastening it is possible to produce.

The stripes or trimmings at each end of the No. 1 and No. 2 handles are made of alternate washers of colored hard fiber and brass or German silver, that are a driving fit on the tang. The center of the No. 1 handle is composed of leather washers put on under heavy pressure and held in place by the nut countersunk into the end of stag tip. The No. 2 is the same construction except that the center is composed of

2 grooved slabs of selected stag riveted together and driven on the tang the same as the washers.

The popularity of the Marble knives is proven by the fact that the sales are considerably more than doubling each year.

NEW GOODS FOR SPORTSMEN.

Three patents have been issued within the last month on fishing reels. One of these is 742,680, to H. E. Vanalstyne, Iliion, N. Y., and 2 others, Nos. 442,568 and 742,587 to H. B. Carleton, Rochester, N. Y. Two of these reels are built on the automatic plan, and the other is on the crank plan with some improvements, which are fully described in the specifications filed with the application. Copies of these patents can be had by writing the Commissioner of Patents, Washington, D. C.

Patent No. 743,856, for a fishing reel has been issued to E. M. Funk, Wytheville, Va. This reel is so constructed that it will work either automatically or by a hand crank. Description of this patent may be had by writing the Commissioner of Patents, Washington, D. C.

E. C. Boren, of Sandwich, Mass., has invented a combination minnow pail and shipping can, on which Patent No. 724,539 has been issued.

E. Sturgill, Eolia, Ky., has secured Patent Na. 728,326 on a new locking device for fire arms.

Patent No. 743,420 has been issued to Andrew Arnesen, of Des Moines, Iowa, for an animal trap constructed with an oscillating cylinder. Full description and copies of the patent can be obtained by writing the Commissioner of Patents, Washington, D. C.

R. L. Hunter, of Minneapolis, Minn., has been granted Patent No. 728,717 on a fishing reel, for which some important improvements over other reels are claimed.

ENDORSES COLLAN OIL.

New York Zoological Park,
New York.

Mr. J. R. Buckelew,
No. 111 Chambers street,
New York City.

Dear Sir:—

We have made a careful test of your Collan oil in comparison with another oil which we have been using for softening and waterproofing the shoes of some of our men. For 6 weeks we had one of our men grease one shoe with Collan oil and the

other with oil of another kind, such as we had previously been using, on the supposition that it was the best obtainable. At the end of the 6 weeks the leather that had been treated with your oil was soft and pliable; while the other was stiff and hard, from the action of water which had, apparently, dissolved out the oil. This leaves no question in my mind as to the superior quality of Collan oil, both for waterproofing leather and for keeping it soft under the most adverse circumstances.

I send you herewith an order for a 6 months' supply.

Yours truly,
W. T. Hornaday, Director.

LEARN HOW TO MAKE MONEY

The Plymouth Rock Squab Co. has moved its Boston office and is now established at 289 Atlantic avenue, that city. They have the second floor of a new building never before occupied. There is a passenger elevator, freight elevator, steam heat, electric lights, and every convenience. The company has 3,000 square feet of shipping floor, which is more than double what they had at Friend street. The new office is half way between the North and South stations, within 6 minutes' walk of the post-office, and half way between the State street and Rowe's wharf stations of the elevated road.

During the past year this company has made important additions to its plant at Melrose, Mass., 8 miles North of Boston, and now has a large amount of money invested there. This year the outlook is for about double the business they did last year.

Raising squabs for market is a money-making business, and can often be carried on as a side line. Anyone who is interested should write the Plymouth Rock Squab Co., at their new address, for a copy of their free book, "How to Make Money with Squabs." In writing please mention RECREATION.

ONE HUNDRED ACRES OF OLD IVORY.

The buildings of the Louisiana Purchase Exposition, which will open at St. Louis April 30, 1904, resemble old ivory, and they present the most marvelous spectacle of its kind ever seen on the earth. It is not likely that anything approaching this will be seen again for many a year.

The buildings themselves occupy 131 acres. Those of the Columbian Exposition, Chicago, the next greatest, occupied only 82 acres. The entire space covered by the World's Fair at St. Louis is 1,240 acres, which is twice as large as that of any previous exposition.

A large folder containing much interest-

ing information, a map of the grounds, and pictures of many of the buildings, has just been issued by the New York Central Railroad, and will be found of immense interest to every person who thinks of attending this last and greatest of the World's Fairs. A copy will be sent free post-paid on receipt of 2 2-cent stamps, by George H. Daniels, General Passenger Agent, Grand Central Station, New York.

AS TO MANCHURIA.

The eyes of all the world are on Manchuria. It is a country of which we know practically nothing, and war time is the right time to study unfamiliar territory. A correct map and other information of a specific character regarding that country are given in folder No. 28 of the New York Central's "Four-Track Series," issued by George H. Daniels. As a rule, not much reliance can be placed on railroad maps, but Daniels' map of Manchuria is the best in print. It certainly is cheap enough for the poorest of us. It should be stuck up in every public school, and Manchuria should be the geographical objective for some months.

A copy of No. 28, "A New Map of Asia and the Chinese Empire," sent free, on receipt of 7 cents in stamps by George H. Daniels, General Passenger Agent, New York Central Railroad, Grand Central Station, New York.

Star Island, Mich.

A. W. Bishop & Son, Racine, Wis.

Dear Sirs: June 23, 1902, I bought one of your Independent Even Spooling Reels and am much pleased with it. In casting off the dock here General Shattock and Doctor Boyer, of Cincinnati, Ohio, Dr. Gremmill, of Forest, Ohio, and Attorney Jordan, of Findlay, Ohio, cast 150 feet with it, and had I had any more line on the reel they would have cast farther. Attorney Kidder also cast all but 2 turns off the reel. Mr. Nat. C. Goodhue, of Aurora, Ohio, offered to bet \$100 he could cast 200 feet with it. In fact, you will hear from all of them, for they are enthusiastic over it. I told them I paid \$5.50 for my reel and that you had a similar reel with jeweled bearings for \$6.50 or \$7. Yours truly,

Geo. W. Bouse,
Cleveland, Ohio.
3 Mile Bay, N. Y.

The Passenger Department of the Canadian Pacific Railway has issued a small map, showing a section of country between the C. P. R. and Lake Huron, including the Mississaga river and its tributaries, which will prove of deep interest to all canoeists

and nature lovers. With the aid of this map a man can go West on the main line of the C. P. R. to Bisco Station, put his canoe into one of the many small lakes in that vicinity, run down into Mississaga river and down that to Desbarats Station on the Southern line of the C. P. R. Men who have been over this course describe it as one of the most interesting and fascinating regions in Canada. The country is entirely wild and game and fish are abundant. If you are interested in finding such a place, write C. E. E. Ussher, G. P. A., Montreal, Can., for a copy of the map, and mention RECREATION.

The Cedaroleum Co.,
Perkinsville, Vt.

Dear Sirs: Some time ago I ordered a sample of Cedaroleum, and have given it a thorough test. Am highly pleased with it, and believe it will do everything claimed for it. It is especially good for the 22 caliber rifle, which is one of the hardest guns to keep clean. Cedaroleum does the work perfectly, and if used according to directions there need be no fear of the rifle turning black or pitting after being cleaned.

As you say, oil is too thin and vaseline too heavy. Cedaroleum is put up in such a convenient manner that it is a pleasure to use it, and it has a pleasant odor.

C. W. Ditsworth, Lanark, Illinois.

Mullins, of Salem, Ohio, has issued a new catalogue of his stamped sheet metal boats, which is a novelty in many respects. It is full of pictures and information that must prove deeply interesting to all anglers, duck shooters, canoeists and others who are fond of dabbling in the water. If you are going to have a boat you will find it a great satisfaction to have one that will not shrink or leak every time you leave it out of the water a few days; hence the metal boat is the thing. Write Mullins for a copy of his catalogue. Study it carefully, and see if you do not agree with me. Please mention RECREATION when you write.

The Ideal Manufacturing Company, of New Haven, Conn., has made up and put on the market a smelting furnace for the use of rifle clubs or militia companies desiring to cast their own bullets in large numbers. This furnace holds 50 to 75 pounds of lead, and is intended to be operated by gas.

Persons interested in this announcement can get a circular giving cuts and full information by sending a postal card to Mr. J. H. Barlow, Manager of the Ideal Manufacturing Company, and mentioning RECREATION.

D. M. Tuttle Co.,
Canastota, N. Y.

Dear Sirs:

The 18 foot launch which I bought of you in June, 1903, has given me perfect satisfaction. I have tested the engine under all conditions and I have not been disappointed in a single instance. I believe there is no better motor made nor any so simple to run.

I remain,

Yours gratefully,

H. D. Empie.

Portland, Maine.

Mr. Geo. F. Webber,
Detroit, Mich.

Dear Sir—I beg to acknowledge receipt of the knit hunting jacket No. 4, and thank you much for it. I am greatly pleased with the jacket. It is a beauty; the best yet.

Truly yours,

T. B. Davis.

The Baker Gun and Forging Company, Batavia, N. Y., has employed W. H. More as a salesman. Mr. More has been in the gun business a long time, and is well known to the trade as a pleasant and agreeable gentleman and a master of his profession. I bespeak for him the careful and courteous consideration of gun men everywhere.

Spratts Patent, Newark, N. J., makers of the famous dog and poultry foods and medicines, has issued its 1904 catalogue, which is equally as interesting and valuable as those of previous years, and every owner of a dog, or a bunch of poultry or pigeons should have a copy. When writing for it, please mention RECREATION.

Schoverling, Daly & Gales have bought 46 high grade Hollenbeck hammerless guns, and are selling them at less than half the factory price. Any person wishing to buy a high grade gun at a low price, can secure a bargain by getting one of these Hollenbecks.

I received the Harrington & Richardson gun yesterday and it is much better than I expected.

Fred H. Mann, Evansville, Ind.

The Harrington & Richardson gun you gave me is more than satisfactory.

C. E. Stanford, Worcester, Mass.

The Harrington & Richardson revolver is great. I thank you for it.

L. B. Sayers, Mattawana, Pa.

EDITOR'S CORNER.

SIXTH ANNUAL MEETING OF THE L. A. S.

Each annual meeting of the League of American Sportsmen has been more successful than any of its predecessors, and the one held at Columbus, Ohio, February 10th and 11th, was greater than any of the others. Twenty-five States were represented by League officers or delegates, some States having 3 to 4 each, making an aggregate of 70 accredited representatives.

The Governors of 20 States appointed our officers as official sponsors for the States as well as for the League.

We have always heretofore been able to transact all the business that came before the meeting in one day, but this time it took 2 days of close, systematic work to clear the docket.

The visiting delegates without exception reported greater progress in the work of securing laws, of enforcing them and of creating public sentiment during the last year, than their predecessors had ever given at any of our previous meetings. The number of prosecutions has increased in most of the States, showing a growing activity on the part of the League members and other sportsmen in reporting violations of the law; and it is safe to say that the aggregate of fines collected in all the States during the past year is at least 3 times that of any previous year in the history of the game protective movement. This shows a growing feeling of respect for game and fish laws and a growing contempt for game and fish destroyers, on the part of judicial officers and of men who are drawn as jurors. Every man familiar with the work of game protection knows that up to within 2 or 3 years it was difficult to get a jury anywhere in the rural districts that would convict a man for a viola-

tion of a game or fish law, even though he might plead guilty. The same may be said of justices of the peace. We all know of many cases where men have been taken into a justice's court, charged with the unlawful taking of game or fish, have pleaded guilty and have been discharged by the Justice without punishment.

That time has passed. There is scarcely a judicial officer in the land to-day who does not know that the public at large expects and demands that men who break the laws regarding the protection of fish and game must be dealt with just as severely as men who violate any section of the penal code, and there are thousands of such officers who now give such offenders the maximum penalty when proven guilty.

It is no exaggeration to say that this change of sentiment on the part of the justices, the judges of the higher courts and of the general public, is due to the educational work carried on by the League of American Sportsmen during the past 7 years. We have had a great deal of help in this from kindred societies, but the League has been on the firing line all the time. It has borne the brunt of the battle and has swept away one line after another of the enemy. The other and more conservative societies have helped to hold the ground gained by the League.

The Governor of Ohio and the Mayor of Columbus attended the League banquet and welcomed the visitors in speeches that stirred the souls of all within hearing, and convinced every one that these gentlemen felt deeply the importance and value of our work.

Many members of the Ohio Legislature were present, and several of these gentlemen told me, personally, that they were astounded at the magnitude of the gathering; at the earn-

estness, the strength and the ability of the men who compose the working force of the League.

There were at least 100 Ohio men at the dinner tables, in addition to the visiting delegates, and I heard nearly every one of these men say that the important game protective measures now pending before the Ohio Legislature would go through almost without opposition, and this largely on account of the great influence exerted by the annual gathering of the League.

The Columbus daily papers without exception were most earnest and generous in their treatment of the convention. They gave it column after column, and in some instances half page articles, before, during and after the meeting.

The first 3 annual meetings of the League were held in this city, and during that time no one suggested any other place of meeting. Finally an invitation came from Indiana that we hold our 4th annual meeting in that State. We did so, and at the Indianapolis meeting a delegation came from St. Paul to invite us to hold the next in that city. We went there and on that occasion we had invitations from 2 different States for the 6th annual meeting. We decided on Columbus, and one of the most gratifying features of the recent meeting was that 5 urgent invitations were presented to us there, to hold our 7th annual meeting in the respective States from which these came.

These communications came not only from League members, but from the Governors of States, boards of trade, Audubon Societies, and other strong organizations.

It is a great misfortune that all friends of game protection could not have been in sight and hearing of the earnest body of men who assembled at Columbus, and have heard the encouraging reports made there from all over the land. If certain men who still continue to belittle the work of

this organization could have been there, they would have changed their tactics promptly.

The problem of saving the wild animals and birds of this country is well nigh solved. The laws of many States are practically perfect, and those that still need amending will be made good in the near future. It remains now only to stop, absolutely and at all times, the sale of game in a few Eastern States, such as New York, Pennsylvania and Massachusetts. When this shall have been done we may confidently expect to see game increase rapidly everywhere.

KILL THE POT HUNTERS' GUNS.

The war against the automatic and pump guns goes bravely on. The best sportsmen are almost a unit in condemning these weapons and in seeking the enactment of laws to prohibit their use. There are a few good, clean sportsmen who yet believe the old pump gun is all right, but this number is growing smaller every day. I have letters from a number of such men, saying they are trying to sell their pump guns, and thus get out from under the prohibitory law before it comes. Others say they have hung these guns up on the hooks, and that they will remain there as curios, never again to be used in the field.

One of the most gratifying features of this campaign is the fact that the Audubon women in all the States have taken up the crusade and are bringing all possible influence to bear on their law makers, to induce them to enact our prohibitory measure.

The makers of the pump guns are busy too; but their efforts are directed mainly to the market hunters and other thoughtless game destroyers. The Winchester Company is sending out thousands of copies of a decision rendered by a country judge in California some years ago, in favor of the pump gun and against the good people who are trying to preserve the birds. There is no question that this decision will be reversed whenever a similar case is taken to any of the higher courts.

Here are extracts from a few decisions that will furnish food for reflection, bitter food though it may be, for the champions of the automatic and pump guns:

1. Supreme Court of Minnesota.* *State v. Rodman* (58 Minn., 393, 400).

* "The preservation of such animals as are

*NOTE.—Quoted with approval by the Supreme Court of the United States in *Geer v. Conn.*, 161 U. S., 519, 533.

adapted to consumption as food or to any other useful purpose, is a matter of public interest, and it is within the police power of the State, as the representative of the people in their united sovereignty, to make such laws as will best preserve such game, and secure its beneficial use in the future to the citizens, and to that end it may adopt any reasonable regulations, not only as to time and manner in which such game may be taken and killed, but also imposing limitations on the right of property in such game after it has been reduced to possession. Such limitations deprive no person of his property, because he who takes or kills game had no previous right of property in it, and when he acquires such right by reducing it to possession he does so subject to such conditions and limitations as the Legislature has seen fit to impose."

2. Supreme Court of United States, Smith v. State of Maryland, (59 U. S., 71).

"That part of the law in question containing the prohibition and inflicting the penalty, which appears to have been applied by the State court to this case, is as follows: (1833, ch. 254).

'AN ACT TO PREVENT THE DESTRUCTION OF OYSTERS IN THE WATERS OF THIS STATE.

'Whereas, the destruction of oysters in the waters of this State is seriously apprehended, from the destructive instrument used in taking them, therefore

"Sec. 1. Be it enacted by the General Assembly of Maryland, That it shall be unlawful to take or catch oysters in any of the waters of this State with a scoop or drag, or any other instrument than such tongs and rakes as are now in use, and authorized by law; and all persons whatever are hereby forbid the use of such instruments in taking or catching oysters in the waters of this State, on pain of forfeiting to the State the boat or vessel employed for the purpose, together with her papers, furniture, tackle, and apparel, and all things on board the same.'

"The State holds the propriety of this soil for the conservation of the public rights of fishery thereon, and may regulate the modes of that enjoyment so as to prevent the destruction of the fishery. In other words, it may forbid all such acts as would render the public right less valuable, or destroy it altogether. This power results from the ownership of the soil, from the legislative jurisdiction of the State over it, and from its duty to preserve unimpaired those public uses for which the soil is held.

"So much of this law as is above cited may be correctly said to be not in conflict with, but in furtherance of, any and all public rights of taking oysters, whatever they may be."

3. Supreme Court of United States, (Lawton v. Steele, 152, U. S., 133).

"The preservation of game and fish, however, has always been treated as within the proper domain of the police power, and laws limiting the season within which birds and wild animals may be killed or exposed for sale, and prescribing the time and manner in which fish may be caught, have been repeatedly upheld by the courts."

GIVE IT YOUR AID.

H. R. 11584.

A bill for the protection of wild animals and birds in the Wichita Forest Reserve.

Be it enacted by the Senate and House of Representatives of the United States of America in Congress assembled, That the President of the United States is hereby authorized to designate such areas in the Wichita Forest Reserve as should, in his opinion, be set aside for the protection of game animals and birds and be recognized as a breeding place therefor.

SEC. 2. That when such areas have been designated as provided for in section one of this Act, hunting, trapping, killing, or capturing of game animals and birds upon the lands of the United States within the limits of said areas shall be unlawful, except under such regulations as may be prescribed, from time to time, by the Secretary of Agriculture; and any persons violating such regulations or the provisions of this Act shall be deemed guilty of a misdemeanor, and shall, upon conviction in any United States court of competent jurisdiction, be fined in a sum not exceeding one thousand dollars or be imprisoned for a period not exceeding one year, or shall suffer both fine and imprisonment, in the discretion of the court.

SEC. 3. That it is the purpose of this Act to protect from trespass the public lands of the United States and the game animals and birds which may be thereon, and not to interfere with the operation of the local game laws as affecting private, State, or Territorial lands.

Every sportsman in the land should write his Congressman and Senator at once urging prompt and favorable action on this bill. Our object is eventually to induce Congress to inclose a portion of this tract with a high wire fence and make a quail breeding farm of it. The government would then buy several thousand live birds, amputate the first joint of one wing of each and turn them into this field to breed. Then as fast as the young birds mature they could be netted and shipped to the Northern States for restocking depleted areas.

Please act promptly in this matter and have as many as possible of your friends do so.

BRADFORD'S TWADDLE.

One Bradford, of Masenna, N. Y., has written an article in favor of spring shooting, in which he makes this ridiculous statement:

"One has but to see the immense yearly flight of ducks Northward to be convinced that there is no fear of exterminating the duck family."

Anyone who knows has but to read the foregoing statement in order to be convinced that Mr. Bradford knows practically nothing of the subject he talks about or else that he is deliberately misrepresenting the facts.

Every careful observer of the bird life of this country is well aware that all species of ducks have been steadily decreasing in numbers, for 20 years past. No better evidence of this fact is needed than a comparison of the market quotations of to-day with those of a few years ago. Within the memory of young men of to-day canvasback ducks sold in the markets of this city, during the fall and winter, as low as \$4 a dozen; redheads at \$3 a dozen; mallards, black ducks, widgeon and other common varieties as low as \$2 a dozen.

To-day canvasbacks bring \$45 to \$60 a dozen; redheads, \$30 to \$36; black ducks, ruddy ducks, mallards, widgeon, etc., \$12 to \$15 a dozen.

This, notwithstanding the fact that there are 10 times as many men shooting for the market to-day as there were 20 years ago.

It is unfortunate that such idiots as Bradford should be allowed to talk through the newspapers, for while no intelligent sportsman or naturalist would be misled by his twaddle, there are thousands of other people who do not know the facts and who are likely to take for granted what he says.

Colonel Kingsbury, commanding Ft. Sill, Oklahoma, has shown a most earnest and commendable interest in the cause of game and fish protection. The Ft. Sill military preservation covers 52,000 acres of land, and is thoroughly patrolled every day. Colonel Kingsbury has issued orders that no shooting or fishing shall be allowed on the reservation, either by soldiers or civilians, except during the open season for the taking of fish and game, and he has even prohibited shooting and fishing during a portion of that time. That reservation is large enough to be made a most valuable fish and game preserve, and as a result of Colonel Kingsbury's wise course we may reasonably expect that game and fish will increase rapidly on that tract. I wish the commanders of all the Western army posts could be induced to take similar action.

Game Warden P. W. Shaffer, of Oklahoma, seized 16,000 quails and prairie chickens in the Rock Island yards at that city some weeks ago, that were consigned to the Okcene Produce Co., of Okeene, and the Chester Produce Co., of St. Louis. The birds were packed in 70 barrels, boxes and egg cases, and while the report before me does not say so, it is safe to assume that these cases were not properly labeled as to their contents. Oklahoma has a non-export game law, and in attempting to violate this the shipper undoubtedly violated the Lacey law as well; so it is interesting to figure out the penalty to which the offender is liable. My readers will be advised of the ultimate outcome of this case.

Buffalo Jones, special game warden for the Yellowstone National Park, reports that he has bought and confined under wire fence, 21 head of buffalo. He has also caught 14 calves from among the wild buffalo running at large in the Park. He reports that there are now 33 of these wild bison outside of the enclosure.

I used to find fault with your attitude toward the violators of the game and fish laws, but I now realize that you can not do full justice to these shoats, on account of the postal regulations.

Joseph Thorn, Elgin, Oregon.

She—I will never marry a man whose fortune has not at least 5 ciphers in it.

He—Oh, darling! Then we will be married to-morrow; mine is all ciphers.—Chicago News.

The Harrington & Richardson gun arrived in due time. It more than pays me for the little work I did for you.

J. T. Carr, Victor, Colo.

The Harrington & Richardson revolver is all right and alone worth the money I sent in for 5 subscriptions.

J. W. Bales, Wester, Ia.

Oh, Tom! This brown hair on your coat shows where you have been.

On the contrary, my dear, it shows where you have been.—Exchange.

The Harrington & Richardson gun came to hand. I consider it a present and thank you accordingly.

William Miner, North Billerica, Mass.

Have received the Harrington & Richardson revolver and more than like it.

Geo. Steubenrauch, Collinsville, Conn.

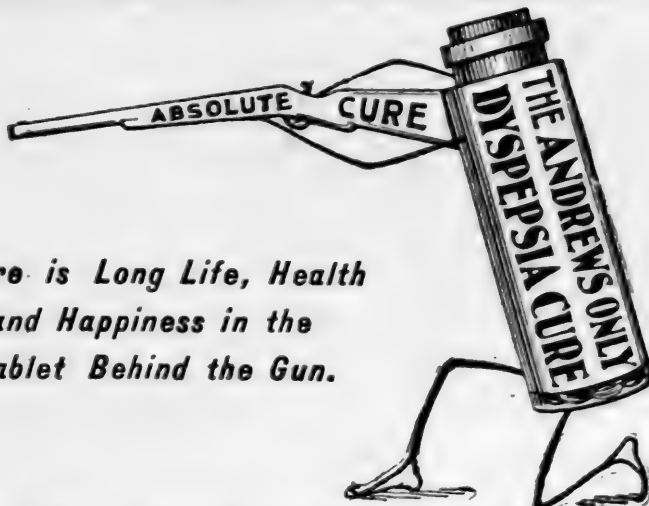

*There is Long Life, Health
and Happiness in the
Tablet Behind the Gun.*

FOR IMMEDIATE AND PERMANENT RELIEF USE

The Andrews Only Dyspepsia Cure

The day you begin using it

YOU CAN EAT ANYTHING YOU LIKE AND ALL YOU LIKE,

as it will both **CURE** and **PREVENT** every form of indigestion or stomach trouble, and correct all ailments incident to Dyspepsia. **GUARANTEED TO CURE OR MONEY RETURNED.**

Not a patent medicine but a secret compound of genuine remedies, endorsed by physicians. Contains nothing harmful in any respect, and

IT WILL CURE. This medicine has been used in parts of New England for 15 years and has never failed to give immediate relief in any case of Dyspepsia, and it will cure all ailments arising from indigestion, and so build up and strengthen one's system as to help it naturally in throwing off any ailment other than those arising from Dyspepsia.

As a Safeguard against impairing one's digestive organs, and for preventing ill effects of all sorts, every person, (ill or well,) should take one of these tablets after heavy eating or drinking, particularly if the food eaten is of an indigestible nature, or if eaten at night.

It does not partly digest food like pepsin, but acts directly upon the stomach, strengthening and regulating it so that it is able to perform its natural functions and correct all sorts of troubles that are incident to indigestion.

GUARANTEED to cure all forms of Dyspepsia or money returned.

DIRECTIONS—For any form of Dyspepsia, Sour or Acid Stomach, Heartburn, Gastritis, Canker, Nausea, Sleeplessness, Bowel Troubles or anything arising from indigestion, chew up and swallow one tablet after each meal, or at any time when needed. Tablets do not contain opiates or narcotics or anything harmful, and dose will not have to be increased after one has used it awhile.

PRICE, 25c postpaid.

As few druggists yet keep it, or know of it, we will supply it by mail on receipt of price.

Address all orders, etc., to the

ABSOLUTE REMEDY COMPANY

HON. J. LEWIS CHILDS, Pres.
HON. CLARENCE LEXOW, Vice Pres.
H. H. DAVIS, Sec'y and Treas.

Floral Park

New York

SAMPLE FREE.—On receipt of a 2c. stamp for postage we will send free a small sample of this wonderful remedy if you mention RECREATION. Try it and be convinced of its value.

Unsolicited Testimonials

DR. CHAS. W. TAYLOR, Lowell, Mass., says: "I have used 'The Andrews Only Dyspepsia Cure' in my private practice, and it has cured when all other remedies failed."

Dr. Taylor is a graduate of Harvard Medical School, late Medical Examiner of Mass. Medical Society, and Physician of Mass. General Hospital, and City Hospital of Lowell.

DR. H. B. EATON, 23 Oak St., Rockland, Me., says: "I have used your Dyspepsia Cure in my practice for the past five years. I use it for Sour Stomach, Heartburn and Water Brash, also spitting food after eating, and distress with pain and nausea. I find that it works very quickly."

MR. CHAS. L. FLINT, of Standard Oil Co., East Cambridge, Mass., says: "Dr. Chas. F. Roberts has recommended to me 'The Andrews Only Dyspepsia Cure,' and I herewith enclose an order for it."

FRANK MELVILLE, 138 E. 14th St., N. Y. City, says: "Having used one box of 'Andrews Only Dyspepsia Cure,' I can with pleasure say that I have been greatly relieved from a case of Dyspepsia and Sour Stomach of several years' standing. Your remedy is indeed a great one."

REV. CHAS. H. HICKOK, Dept. Chaplain G. A. R., Wakefield, Mass., says: "For more than 30 years I have been troubled with Dyspepsia in its most acute forms, accompanied by Nausea, Water Brash, Heartburn, Acidity of stomach, and all its attendant evils. All remedies would only give temporary relief. Three months ago I tried 'The Andrews Only,' which worked like a charm. It has relieved me very largely from all suffering, having only occasional attacks of brief duration, and feel that in the end it will cure me entirely. I heartily recommend your cure."

G. L. GIBBS, Concord, N. H., says: "I have been troubled very much with dyspepsia and weak stomach, and was not able to eat anything hearty without distress. By using your Dyspepsia Cure I can now eat anything."

HON. W. H. I. HAYES, Lowell, Mass., says: (Mr. Hayes is serving his 14th term in the Mass. Legislature.) "I use your remedy and write that people who suffer from indigestion may know that there is a cure. I carry the 'Andrews Only Dyspepsia Cure' in one pocket, my watch in the other. I can live without the watch, but not without the Cure."

MRS. C. A. VUSLER, Delaware, N. J., writes: "I received the tablets of 'Andrews Only Dyspepsia Cure.' It was really a godsend to me. I never had anything give me such relief in so short a time. I enclose one dollar for more."

A REMARKABLE SHOT.

WILLIAM HODGSON.

I had hunted deer in the Adirondacks several seasons, and wanted to try for bear. When I reached the station I was met by my guide, and having provided what I had been told was tempting bait for bear, such as codfish and Limberger cheese, we started for the woods.

We carried with us 2 bear traps and had set one when, going farther up the trail to set the other, we came to a meadow. We stopped to rest and look over the situation. While we were waiting, a big buck walked slowly out of the woods, crossed an opening, and disappeared behind some spruces. I had taken aim at him while he was in the opening, but he looked so large and had such immense antlers that I mistook him for an elk, imagining he had escaped from some game preserve.

After he passed out of sight I made up my mind I was mistaken and that the animal was a deer. He was walking straight away from me when he entered the bushes. Aiming about 6 inches higher than I thought the line of his back would be, and lining up on the direction he had taken when he entered the bushes, I pulled. The guide had not seen the deer, but now we both saw him jump from the thicket into the standing timber. The guide said he thought I had hit the deer.

We went into the thicket, and found blood on the leaves. Following the trail, we soon found big clots of blood. We sat down and waited about 15 minutes, hoping the deer would lie down. Then we took up the trail again and followed it by the blood about 300 yards, when we found the animal, lying on the ground, breathing hard, as if he were dying. I wanted to make sure of him that time, and as I could not get a good aim from where I stood, I stepped carefully to one side, but when I reached a point whence I could get a good look at him, I confess my heart failed me.

The deer raised his head, looked at me with his big brown eyes, and was such a beautiful creature that I simply had not the courage to shoot him as he lay, probably on his death bed. While I stood there studying the unfortunate creature, he jumped. I took a quick aim at his neck and pulled again, but there was no report. For years I had been using a hammerless shot gun, and so had forgotten to cock my rifle. The guide laughed at me, and I would have sold out cheap at that moment; but few words were exchanged between us.

We waited another half hour, when the guide said it was time to go; that the deer would either be dead by that time, or clear out of the country. We started again on the trail, and at that juncture it began to rain. This was indeed discouraging, for we realized that it would soon wash the blood from the leaves, and we should be unable to follow the trail. We walked as fast as we could, but were forced to depend on the impression of the deer's hoofs on the soft

ground, as the blood had entirely disappeared. We were 8 or 10 miles from camp, night was approaching, and the rain was increasing in volume.

The guide proposed going to camp at once and coming back in the morning, but I said that would be entirely useless; that we could not find the track at all by that time; so I insisted on following the trail a little farther.

We pressed on, but soon lost the trail again and made a wide circuit in order to pick it up. After a while we found the track of a big buck, but were not sure it was the one we had been following. Still, we followed. It seemed as if this deer were perfectly healthy, for he was making big, long jumps. I said to myself as we walked along that I would give \$5 to see only one drop of blood.

After following the trail about half a mile we again came up to the deer, and found him lying on a little knoll. I felt sure he was dead, but thought it best to put another bullet in him. This I did, but when we walked up to him we found that was useless, as he was already dead when we reached him.

He was truly a magnificent animal, and we estimated he would weigh 250 pounds. My first shot had gone through one rib and through his lungs.

We went back to the starting point the next day, and paced the distance from where I stood to where the deer was when I fired the first shot. It proved to be 144 yards. I offered the guide \$10 to get the entire carcass to the railway station, but he said it could not be done, as we were 12 miles from there, so I had to content myself with the saddles and the head. The latter I have mounted, and it is indeed a beauty.

That lucky shot broke up my bear trapping, for the weather was warm and I had to bring the venison out at once, in order to save it. I considered a deer in the ice box worth more than 2 bear in the woods.

"There," said the tailor, "that suit certainly fits you perfectly."

"Yes, indeed, you may justly feel proud of that," replied the customer. "It's a credit to you."

"Well—er—I hope you won't forget it's a debit to you."—Philadelphia Press.

I have 3 sons. One is in Congress, one is a yellow journalist, and one is in jail.

Oh, well, don't despair; some day they may all be in jail.—*Mail and Express*.

Will J. L. Lancaster, who wrote the article entitled "Juno, the Retriever," published in January, 1904, RECREATION, please let me know his address?

J. A. Martin, Box 356, Austin, Tex.

"They tell me Skinnem is out for all there is in it."

"No; his customers are out for all they put in it."—Cincinnati Commercial-Tribune.

THE EQUITABLE

HENRY B. HYDE
FOUNDER

J.W.ALEXANDER
PRESIDENT

J.H.HYDE
VICE PRESIDENT



DO YOU KNOW

that you can buy 5% Gold Bonds on instalments — and have them insured while you are paying for them?

A good investment for you — if you live. A splendid protection for your family — if you die.

Opportunities for men of character to act as representatives.
Apply to GAGE E. TARBELL, 2ND Vice President.

Send this coupon, or write, for particulars.

THE EQUITABLE LIFE ASSURANCE SOCIETY of the United States
120 Broadway, New York Dept. No. 16

I would like to receive information regarding a Gold Bond for \$.....
issued to a person aged years.

Name..... Address.....



AMATEUR PHOTOGRAPHY.

"For sport the lens is better than the gun."

I wish to make this department of the utmost use to amateurs. I shall, therefore, be glad to answer any questions and to print any items sent me by practical amateurs relating to their experience in photography.

THE ANNUAL COMPETITION

RECREATION has conducted 8 amateur photographic competitions, all of which have been eminently successful. The 9th opens April 1st, 1904, and will close November 30th, 1904.

Following is a list of prizes to be awarded:

First prize: A Long Focus Korona Camera, 5 x 7, made by the Gundlach Optical Co., Rochester, N. Y., fitted with a Turner-Reich Anastigmat Lens, and listed at \$85.

Second prize: A No. 3 Folding Pocket Kodak, made by the Eastman Kodak Co., Rochester, N. Y., fitted with a Bausch & Lomb Lens, Plastigmat Unicum Shutter, and listed at \$61.50.

Third prize: A Royal Anastigmat Lens, 4 x 5, made by the Rochester Lens Co., Rochester, N. Y.; listed at \$36.

Fourth prize: A Waterproof Wall Tent, 12 x 16, made by Abercrombie & Fitch, New York, and listed at \$32.

Fifth prize: An Al-Vista-Panoramic Camera, made by the Multiscope and Film Co., Burlington, Wis., and listed at \$30.

Sixth prize: A No. 3 Focusing Weno Hawkeye Camera, made by the Blair Camera Co., Rochester, N. Y., and listed at \$27.50.

Seventh prize: A high grade Fishing Reel, made by W. H. Talbot, Nevada, Mo., and listed at \$20.

Eighth prize: A Tourist Hawkeye Camera, 4 x 5, and made by the Blair Camera Co., Rochester, N. Y., and listed at \$15.

Ninth prize: A Bristol Steel Fishing Rod, made by the Horton Mfg. Co., Bristol, Conn., and listed at \$8.

Tenth prize: A pair of High Grade Skates, made by Barney & Berry, Springfield, Mass., and listed at \$6.

The 10 next best pictures will each be awarded one dozen 8 x 10 Carbutt Plates, made by the Carbutt Dry Plate Co., Wayne Junction, Philadelphia, Pa.

The 10 next best pictures will each be awarded one dozen 5 x 7 Carbutt Plates.

The 10 next best pictures will each be awarded one dozen 4 x 5 Carbutt Plates.

A special prize: A Goerz Binocular Field Glass, listed at \$74.25, will be given for the best picture of a live wild animal.

Subjects are limited to wild animals, birds, fishes, camp scenes, and to figures or groups of persons, or animals, representing in a truthful manner shooting, fishing, amateur photography, bicycling, sailing or other form of outdoor or indoor sport or recreation. Awards to be made by 3 judges, none of whom shall be competitors.

Conditions: Contestants must submit 2 mounted prints, either silver, bromide, platinum or carbon, of each subject, which, as well as the negative, shall become the property of RECREATION. Negatives not to be sent unless called for.

In submitting pictures, please write sim-

ply your full name and address on the back of each, and number such prints as you may send, 1, 2, 3, etc. Then in a letter addressed Photographic Editor, RECREATION, say, for instance:

No. 1 is entitled — — —.

Made with a — — — camera.
— — — lens.

On a — — — plate.

Printed on — — — paper.

Length of exposure, — — —.

Then add any further information you may deem of interest to the judges, or to other amateur photographers. Same as to Nos. 2, 3, etc.

This is necessary in order to save postage. In all cases where more than the name and address of the sender and serial number of picture are written on the back of prints I am required to pay letter postage here. I have paid as high as \$2.50 on a single package of a dozen pictures, in addition to that prepaid by the sender, on account of too much writing on the prints.

Any number of subjects may be submitted.

Pictures that may have been published elsewhere, or that may have been entered in any other competition, not available. No entry fee charged.

Don't let people who pose for you look at the camera. Occupy them in some other way. Many otherwise fine pictures have failed to win in the former competitions because the makers did not heed this warning.

PHOTOGRAPHIC POST CARDS.

The use of souvenir post cards has become almost universal. In some localities the revenue derived from post cards during some seasons of the year exceeds the revenue from the sale of stamps for letters, and the Post Office Department has adopted liberal rules, so that almost anything mailable can now be sent as a post card. It is only necessary that the card should bear, on the address side, the words "Post card," and in addition only the address should be on that side.

The opportunity for the amateur photographer to make his own post cards becomes easily within the reach of all. There are many possibilities in this direction. The negatives already on hand may be used, and the artistic ideas expressed may add a great interest to the message sent an absent friend.

If the amateur is the possessor of a small printing press, the printing of a number of post cards will occupy only a short time. If not, a rubber stamp, containing the words "Post Card," in large clear type, can be used. A good quality of bristolboard will answer the purpose, and can be easily cut to the desired size, 3¼x5½, by the ordinary print trimmer.

It is then necessary to sensitize the cards for printing. The simplest form of sensitizer is the ordinary blue print solution. Formulas for the solution can be found in any of the annuals devoted to photography. For those who do not care to compound the blue print solution there are sensitizing powders on the market which are readily dissolved and easily manipulated.

I can not urge too strongly the careful selection of the negative for the small print which is to be used to decorate the post card. It often happens that a choice view may be found in some corner of a negative which taken as a whole would be utterly lacking in interest. The close study of the negatives on hand is recommended. These should be examined not only as a whole but with reference to tiny portions which might be selected and used as an enlargement or a reduction, as their size may require.

The choice of the best portion of the negative may be aided and time saved by the use of several differently formed masks, the opening of which is to represent the size of the picture. The masks exclude other portions of the negative from consideration. This enables the mind to select with much greater readiness such portions of the negative as may seem of the greatest interest.

In sensitizing the cards cover with a piece of blotter such portions of the card as are not to be included in the picture. Apply the sensitizer with a wad of absorbent cotton, remembering that a thin coating of the sensitizer is all that will be required. The fingers should always be protected from contact with the sensitizer by rubber finger tips.

With the blue print picture card a thorough washing is all that is needed to complete the picture after it has been printed. With other sensitizing solutions some chemical method of fixation is usually required. For that ample directions are contained with the sensitizing powders. If the words "Post Card" are to be printed by the use of a rubber stamp, omit such printing until the picture has been printed and fixed and washed. Otherwise the ink used for the stamp might become so much washed out and mingled with the picture, that an undesired effect would be obtained.

For that class of negatives which seem to be so well composed that a small portion can not be used without destroying the best effect of the picture it will be well to make a reduced transparency on a lantern slide plate, and from this make a small negative by contact. To those who own an enlarging and reducing camera this will be easy, but for those who are obliged to depend on homemade apparatus, the reducing of negatives will entail no small labor.

A board will be needed, of sufficient length to represent the distance required from the negative to the camera, in order to reduce the negative to the size of a lantern plate or smaller. At one end of this board fasten rigidly a box large enough to admit the largest negative to be reduced. In the bottom of the box cut an opening slightly smaller than the negatives from which the reductions are made, and furnish the box with parallel cleats so that the negatives can be placed in the grooves thus formed. At the other end of the board nail parallel strips of $\frac{3}{4}$ inch board so that the view camera will slide between these strips with just enough friction to keep it in proper position. A groove should also be cut through the board to admit the tripod screw, by which the camera can be secured at any point after the correct size of the reduction has been found. The distance between the camera and the box containing the negative can be covered by the focussing cloth laid on strips of wood resting at one end on the camera, and at the other end on the box in which the negative is secured. This apparatus can be easily prepared by any one from the usual articles found about the home; and the flat-dweller can utilize the family ironing board for the camera stand if other boards are not available.

It will naturally suggest itself to the camera worker that the box containing the negative will have to be placed so it may receive the light from a window, and that the light should be diffused by the use of tracing cloth or tissue paper. It will also be known to all that a kit to contain the lantern slide plate can be made from card board so it can be used in the ordinary plate holder in the same manner as the usual negative plate. When it seems necessary to enlarge a portion of the negative a similar apparatus will answer the purpose, provided the camera is furnished with a sufficient length of bellows.

It may be, however, that some of the readers of this article have little time during the day that can be devoted to photography. For this class there is abundant opportunity to prepare the post cards from papers which are designed for use by artificial light. Several manufacturers of bromide or gaslight papers have placed on the market post cards ready for exposure. These goods are easily manipulated and the results are all that the most exacting could wish. In this kind of work use printing frame of liberal size, so that all sizes of negatives can be accommodated with one frame. Cover the inner portion of the glass of the printing frame with a heavy non-actinic paper. In the lower right corner of the paper mark off a space of the exact side of the post cards to be used, and

frame the right angle line thus formed with strips of cardboard, forming in this manner an angle in which the post cards may be placed. Each card will then be in accurate register. Cut an opening through the thick paper of sufficient size to accommodate the largest picture to be used, and by the use of masks on the negatives it will be possible to bring each picture in proper position on the card.

In making a series of exposures from different negatives, select either a negative of the greatest or the least density of the collection, and from this make a standard of exposures, varying the exposure as the different negatives are denser or thinner than the standard selected. It is also advisable to have a fixed distance for exposure between the lamp or gas jet and the printing frame. Adopting such a distance gives one known condition, and the only remaining condition to be considered is the length of exposure, which should be governed by the condition of the negative used as related to the standard.

Concerning the manipulation of the sensitized post cards it will usually be sufficient if the directions which accompany the paper are intelligently followed. Much of the success in the technical side of photography consists in following implicitly the formulas given.

There will doubtless be found many friends who will wish to have post cards made from favorite negatives, and in such a case a means of money-making is at once afforded.—Chas. E. Fairman, in *The Camera and Dark Room*.

TO MAKE PYRO DEVELOPER.

I should like to inquire through RECREATION of R. L. Wadhams, M.D., Wilkes-Barre, Pa., what formula he would recommend for making pyro developer, and how to size such developer.

I read his article in November RECREATION entitled, "Why the Amateur Should Use Pyro," and was much interested in it.

I have been using Stanley plates of late, but I have trouble from pin holes in them. I dust the plates with a soft camel's hair brush before and after exposure, as recommended by the plate company, but I get pin holes just the same. Can you suggest any way of preventing them?

W. D. Lewis, Lynn, Mass.

ANSWER.

My developing solutions are as follows:

A.—Pyro, 1 ounce.

Saturated solution of oxalic acid, 2 drachms.

Water, 16 ounces.

B.—Sodium sulphite, T 80; or

Crystals, 10 ounces, or dry, 5 ounces.

Water, 30 ounces.

C.—Sodium carbonate, T 40; or

Crystals, 6 ounces or dry 2½ ounces.

Water, 30 ounces.

Use 1 ounce of each, A. B. C. Water, 7 to 12 ounces; or use:

A.—6½ drachms, water, 7½ to 12½ ounces.

B.—6 drachms.

C.—1 ounce.

By using this 3-solution developer, I can make up any mixture to correspond to the formula given by any plate maker for his individual plate; always remembering the following rules: Too much pyro chokes up the whites and gives too much contrast; too little pyro gives slow development and lack of contrast. Too much sulphite gives blue negative; too little, a brown negative and stain. Too much soda makes fog, and dense, flat negatives; too little makes contrast and slow development. Addition of water makes negative in high lights and gives detail; less water gives contrast. Hence I vary the preparations according to the kind of negative I want.

In regard to bubbles, I never wet the plate before developing. I try to pour the developer over the whole plate with one motion. I have few air bubbles.

As regards pin holes, I doubt if dust plays so important a rôle as is supposed. It is an easy excuse for those manufacturers who make dirty plates. Try dusting ½ of the plate and see if you can tell, after development, which half was dusted. I suggest that Mr. Lewis try another make of plates.

R. L. Wadhams, M.D., Wilkes-Barre, Pa.

After my exposed plates have been laid away some time the film side becomes frosty looking. This appearance can be readily corrected by soaking the film in pure water, and while immersed using a camel's hair brush gently over the emulsion. Will you please state cause of this appearance and remedy? Have always taken great care with original washing.

A. N. Wolff, St. Paul, Minn.

ANSWER.

In all probability the white deposit you find on your negatives is sodium hyposulphite which was not completely washed out. To test it make a stock solution of potassium permanganate 20 grains, sulphuric acid 1 drop, water 2 ounces. Dilute a small quantity of this solution with water until the color is light. Add to this the water in which the negatives were washed to remove the white deposit; if it is hypo the solution will lose its color. The remedy would be to wash the negatives longer in running water.

If the negatives were stored in a damp place it is possible the deposit is a mould.

—EDITOR.



VELVET VELOX

A new Velox paper with a semi-gloss surface that adds lustre and life to the shadows. Its breadth of gradation adapts it to use with almost any negative.

Furnished in single or double weight and as Post Cards.

ALL DEALERS.

Nepera Division,
EASTMAN KODAK CO.,

Rochester, N. Y.



"99% of Camera Value is in the lens"



The "Style B" Goerz lens lets light through with the least possible resistance—this is necessary for instantaneous photography. Our new formula for the Goerz Style B has produced a lens which enables the amateur to make pictures under conditions which have heretofore been considered unfavorable. When you buy a camera tell the man you want a Goerz Lens.

Sample Photographs sent on request

C. P. GOERZ,

Room 27, 52 E. Union Square, New York City

I received the boots. They are certainly fine, and I so appreciate your generosity in presenting them to me for so few subscriptions to your estimable magazine, that I shall endeavor to secure new readers for RECREATION as long as it is published.

A. J. Durand, Moorestown, N. J.

There was a young lady named Perkins,
Who was exceedingly fond of small gherkins;

So many she ate,
That, sad to relate,
She pickled her internal workin's!

—Exchange.

Cholly—Cawn't imagine what's the mattah with Gussie. There seems to be something preying on his mind.

Miss Sharpe—Oh! whatever it is, let it alone. It will probably die of starvation.
—Philadelphia Ledger.

I have tried the Harrington & Richardson gun and found it O. K. It is more than worth the little trouble I had in getting subscriptions.

R. C. Finlay, New Orleans, Ia.

I received the J. C. hand trap which you gave me as a premium, and am delighted with it. Please accept my thanks for same
Wm. Keller Meyer, Columbus, O.



A RECORD

of all the happenings and incidents of your trips enables you to enjoy them over and over. The BEST records are made with

COLLINEAR LENSES

The fastest and truest lenses; fit any camera.

Send for Booklets to

**Voigtlaender & Son
Optical Co.**

137 West 23d St.
Dept. E New York

PREMOS and POCOS

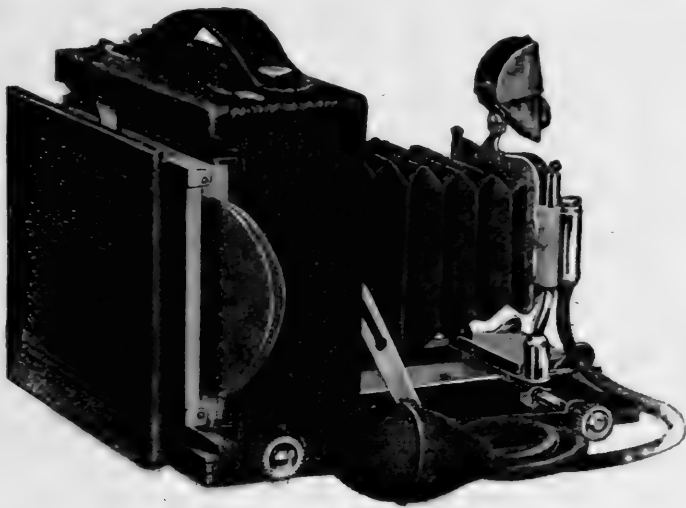

*as
Film
Cameras*

By means of Premo Film Pack Adapter any $3\frac{1}{4} \times 4\frac{1}{4}$ or 4×5 Premo or POCO becomes a daylight loading film camera, and you may

**Focus on the
Ground Glass**
Just as with Glass Plates

The Film Pack (12 exposures) loads into Adapter in simplest possible way. After exposure, a single motion presents next film

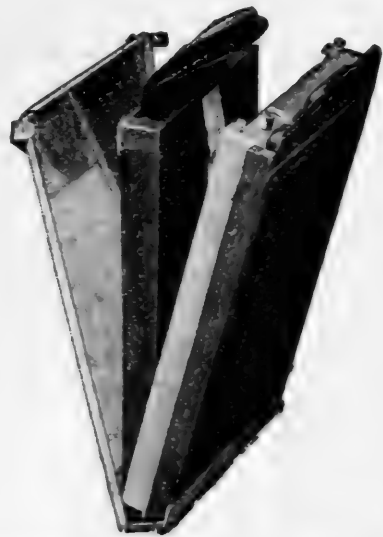

ADAPTER—size of ordinary plate holder

$3\frac{1}{4} \times 4\frac{1}{4}$ Premo Film Pack Adapter	-	-	-	-	-	\$1.00
Premo Film Pack, 12 exposures $3\frac{1}{4} \times 4\frac{1}{4}$	-	-	-	-	-	.70
4×5 Premo Film Pack Adapter	-	-	-	-	-	1.50
Premo Film Pack, 12 exposures, 4×5	-	-	-	-	-	.90

For use with Film Pack only

PREMO FOLDING FILM CAMERA

PREMO BOX FILM CAMERA

Rochester Optical Co.,

**ROCHESTER
NEW YORK**

Send for 1904 catalogue, which is now ready



COMBINATION HAWK-EYE

A New Film Camera which allows the operator to focus on ground glass.

May also be used with glass plates.

Fitted with Extra Rapid Rectilinear lens, B. & L. Automatic Shutter, rising and falling front controlled by rack and pinion.

No. 3 Combination Hawk-Eye, pictures $3\frac{1}{4} \times 4\frac{1}{4}$, equipped for film and plates, - - \$27.50

BLAIR CAMERA COMPANY,

ROCHESTER, N. Y.

Send for Catalogue.



Something Special — Playing Cards Free:—To each person sending me \$1 for one year's subscription to RECREATION, or sending it direct to be placed to my credit, I will forward, all charges prepaid, a pack of elegant gold edge playing cards. These are no cheap second quality cards but first quality of extra selected stock, highly enameled and polished, fancy set pattern backs, each pack wrapped in handsome glazed wrapper and packed in strong telescope case.

L. J. Tooley,

141 Burr Oak St., Kalamazoo, Mich.

I received the Webber knit jacket you had sent to me for 3 subscriptions. It is just the thing for wearing around the house and for hunting or fishing. I thank you for sending it so promptly.

F. W. Latz, Minneapolis, Minn.

I have received the Davenport gun that I earned as premium, and find it entirely satisfactory in every way. I have shown it to lots of my friends and they are surprised to know that a gun can be got with so little expense and labor.

J. A. Barnea, Exeter, N. H.

For Golf & Tennis Players

"PRESTO! — CHANGE!"

ATTACHABLE EYEGLASS TEMPLES



Eye Glasses into Spectacles. Spectacles into Eye Glasses

BE PROTECTED!

DON'T BREAK OR LOSE YOUR GLASSES IN EXERCISE, WIND AND STORM

Can be attached by anyone

Send thickness of lens when ordering by mail

Price in Nickel 50c. a pair.

Gilt 75c. a pair.

Gold Filled \$1 a pair.

Solid Gold \$2.50 a pair.

Established 1842

GALL & LEMBKE, Dept. C, 1 W. 42d St.

21 Union Sq., New York

Send for Circular



PATENTED
June 17 1902



COVERED BY
Foreign Patents.

It's Not a Toss-Up



as to the quality of pictures made with a

KORONA Camera

IT'S ALL
IN THE
LENS

GUNDLACH-MANHATTAN OPTICAL CO., 730 So. Clinton Ave., Rochester, N. Y.

YOU CANNOT BUY A

KORONA CAMERA

from the Photographic Dealer nowadays because the
P H O T O G R A P H I C T R U S T
 prohibits it, in effect, by making him forfeit a large
 part of his profit on *their* goods, if he dares to buy
 and sell *ours*.

If your dealer is one of these, or if no dealer in
 your town handles our products, **we'll let you keep
 the profit the dealer formerly made.**

Write for catalogue and discounts. This is an
 unprecedented opportunity to buy the peerless
KORONA CAMERA at wholesale price. We
 manufacture also **BINOCULARS, TELE-
 SCOPES, MICROSCOPES** and other optical goods

Gundlach-Manhattan Optical Co

730 South Clinton Avenue, Rochester, N. Y.

"Century" Cameras

Those same qualities of excellence in "Centurys" which appeal to expert photographers, make these Cameras also the best for beginners.



The Revolving Back gives "Century Quality" the consummating feature to make Century Cameras a thoroughly distinctive line,

"Centurys" use Film Packs, Film Cartridges, or Glass Plates.

FREE 65-page 1904 Art Catalogue. Write to-day.

CENTURY CAMERA CO., ROCHESTER, N. Y.



OIL PORTRAITS ON APPROVAL

If you will send me a photo of yourself or a friend and state color of hair, eyes and complexion, I will paint and send you on approval an oil or pastel portrait, miniature or life size.

Canvas, 6x8 or 8x10 inches,	\$10
Canvas 10x12 or 12x14 inches,	\$15
Three-quarters life size, - -	\$25
Full life size, - - - - -	\$35

Z. EMMONS, 58 West 104th Street

Reference: Mr. G. O. Shields. **New York**

Accept my hearty thanks for the Davenport gun. It is a beauty and the best of its kind around here.

C. M. Hartwell, Waukesha, Wis.

LANTERN SLIDES COLORED SKILLFULLY AND ARTISTICALLY

FOR
Lecturers, Teachers and others

I refer by permission to the Editor of RECREATION

MRS. C. B. SMITH

**The Ansonia, 74th St., & Broadway,
New York City.**

Free: To anyone sending through me \$1 for 1 yearly subscription to **Recreation**, I will give a sportsman's pocket medicine case. For 2 subscriptions, a physician's pocket medicine case. Walter Lusson, Ardmore, Pa.

IN ANSWERING ADS PLEASE MENTION RECREATION.

We conduct monthly contests with over
\$20.00
IN PRIZES

Amateur Photographers!

Hundreds of subscribers tell us we are publishing the best magazine for amateurs. You **must** see a recent number—send 2-cent stamp.

Current issue, with 1904 Prize Announcements for 10c. stamps or coin. Send at once and get our new Clubbing Offers and big Premium List under which you get

A YEAR'S SUBSCRIPTION FREE

**Western Camera Notes, 826 Hennepin Ave.
Minneapolis, Minn.**

Buying a Camera?

What Lens?



NOT GAME.

Early on the morning of August 8th, last, I shouldered my Parker and struck out for a hickory grove South of my house and near the old sugar camp where, in my boyhood, I used to tote the sugar water. I made my way to the top, which is pretty steep for old legs to climb. Getting there I stopped to listen. I soon heard grays cutting and presently a fine fellow ran from one hickory to another to get a nut. Just then a load of No. 6's brought him down in good shape, a clean kill.

Standing still a few minutes, I got in another shot; a clean kill was the result. Soon another gray made a rush off a hickory on to a small tree near, stopping on a limb. He did not offer a very good mark. I dropped him, however, but seeing he was about to get into a tree with a hollow near the ground, I sent the second load of 6's after him. I would rather score a clean miss than cripple my game. Having 3, I gathered them up and went home. I always make it a rule to stop shooting when I have a reasonable bag of any kind of game. I think 3 or 4 squirrels or rabbits should satisfy any one.

R. B. Stowers, Cupio, Ky.

I regret to learn that you still hunt gray squirrels. I fear you have not been reading RECREATION as closely as you should, or you would certainly have concluded before now that the gray squirrel should not be killed at any time.—EDITOR.



KODAK Progress.

Whatever is new and desirable in picture taking is found in the Kodak System—Non-Curling film, daylight development—absolute simplicity.

Ask your dealer, or write us for the 1904 Kodak Catalogue. It's an illustrated photographic news letter from Rochester, the Home of the Kodak.

EASTMAN KODAK CO.

Rochester, N. Y.

Kodaks
\$5.00 to \$97.00

CAMPING IN COLORADO.

A. L. COLE.

We outfitted at Leadville, a way-up mining town. The organizer, paymaster, guide, scout, angler, game smeller and physician in charge of the party was Dr. J. H. Cole. The other members were his wife and son, and Mr. and Mrs. A. L. Cole, of DuBois, Pa. The doctor provided a good team and wagon, mattresses, a large wall tent, stove and cooking utensils, plenty of provisions and fishing tackle, guns and ammunition. We headed for Bear river, Routt county. The route lay over Tennessee Pass, down the Eagle river, across the divide of the waters of the Grand, then over another divide to Bear river, and down the Bear nearly to Hayden.

From the first night out, which was spent on the Eagle, to the return, covering nearly 4 weeks, we had trout in abundance.

If Nature had intended to provide an almost perfect country for such a trip she could not have succeeded better. The climate is superb, game abundant and scenery sublime. The whole distance presents one grand and wonderful sight, but so varied and changing that there is no monotony in the scene.

Before leaving the railroad line, we spent Sunday at Red Cliff, a small mining town on a narrow strip of land along the Eagle river, with mountains so high that the sun appears late and disappears early in the day. We selected the only level spot to be found for a camp site, and discovered Sunday morning that we were within 20 feet of the home plate on what was used as a base ball ground. We were entertained Sunday by a game between Red Cliff and Leadville, which was witnessed by almost the entire population of the town. They could not be charged with sacrilege, considering the life they had to lead the other 6 days of the week.

Near this town, on the mountain top almost directly above it, is the little town of Gillman, built so near to the precipice of Eagle River canyon that it makes one's head swim to walk the main street, with the roaring river 2,000 feet below and almost squarely underneath. One daredevil has built his house on a projecting cliff so it can only be approached from one way, and if he should happen to step out the back door, he would be dashed to the rocks, hundreds of feet below.

On this great peak, known as Battle mountain, by reason of some traditional Indian battle, there are rich gold mines, driven in the sides in places almost inaccessible.

After leaving the line of the railroad at Wolcott, the road leads through a succession of cedar hills where the soil and rocks are as red as paint, and the cedars as blue as the sky. Just before reaching the Grand river, we camped 3 days at Leary's ranch on Piney creek. This is the first trout stream

I ever had the pleasure of casting a fly on. An hour's fishing at any time would give us 10 pounds of the finest trout anyone ever saw. The Doctor caught one that measured 17½ inches in length.

After reaching the head waters of the Bear river, one is in a beautiful grassy valley, the home of the cattle grower and the hay farmer. This valley seems to be natural timothy land. Wherever a little water can be run on the soil it produces a wonderful growth of clean timothy.

The next stop was at Steamboat Springs, a little town with a big name, and a long way from a steamboat. Here are several hundred springs, of all varieties one can imagine; hot, warm, cold, soda springs, sulphur springs, milk springs, iron springs, and several other kinds, all in close proximity to one another, and of all sizes and smells. There is a large building used as a bath house, with several vats or pools, 16 by 20 feet in size and 3 to 6 feet deep, supplied with hot water direct from the earth. For 25 cents one can enjoy the most delicious bath that can be wished for.

At the end of the journey, 20 miles below, we found an old Pennsylvanian in a log hut, alone except for a dog that danced to the music of his violin. We felt at home there, with a man not only from our own State, but one who was graduated in the same class in a Pennsylvania school with our present Governor. Thus are demonstrated the favors fortune bestows; but when one considers all, is it not hard to tell which one she has favored, the one whom she has made Governor of a great State, or the one whose lot has been cast in the heart of the great Rocky mountain wilderness, in the midst of all nature's primitive blessings?

In a week's stay at this place, we saw deer every afternoon from our tent door, and in a short trip up any one of the many canyons or gulches a dozen could be seen any evening. Of course they did not all get away.

From there we retraced our route, and reached Leadville in the midst of an August snow squall, having had a most delightful and profitable trip. Its delight and its success were due first to Doctor and Mrs. Cole, and second to the good people along the way, all of whom seemed waiting to do some act of kindness for the camper, of whom there are many in that country.

Pleasant associates, a delightful climate, enchanting and wonderful scenery, plenty of fish, grouse, sage hens, and an occasional deer! What more could we ask for to make a camping trip complete?

Then you admit having killed deer and grouse in violation of the State law. I need not tell you this is wrong. You know it as well as I do. You have laid yourself liable to arrest and prosecution, and in case you return to Colorado at any future time, the State game warden should prosecute you to the full extent of the law.—EDITOR.

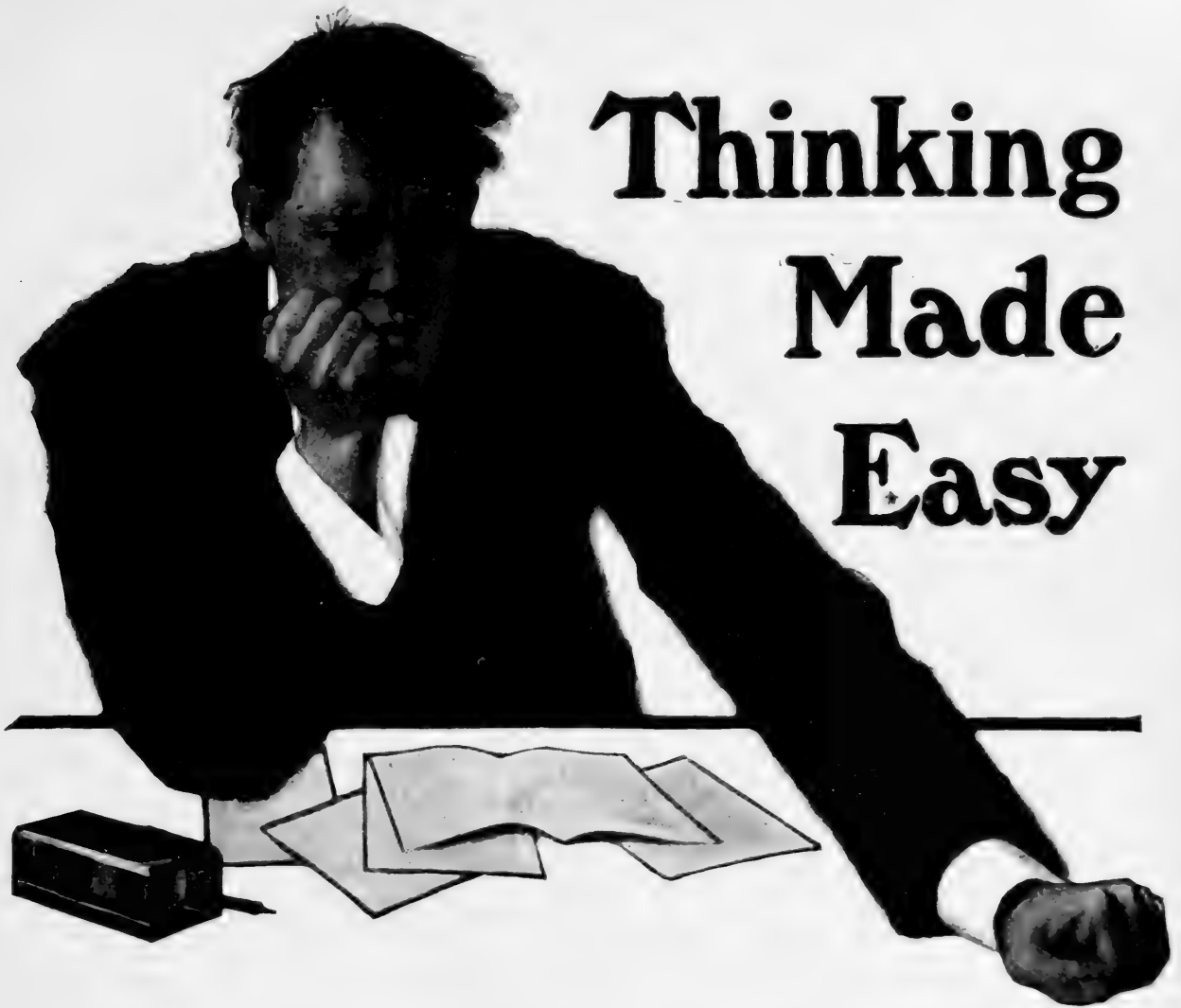

Thinking Made Easy

An underfed Brain that has gone tired is a poor tool and can't do good work.

For Brain is physical—wears away under the daily grind just like flesh or muscle and **MUST BE REBUILT** by selected food.

When the proper food **GRAPE-NUTS** is selected the greatest brain maker in the world is put to work in you, rich in the Phosphates that fill the delicate little gray cells in the Nerves and Brain, and in a short time you will feel a vigor and renewed mental strength that can come only to the properly nourished Brain.

A strong, keen, money-making set of brains **CAN BE BUILT ON GRAPE-NUTS** and anyone who wants such a set of "thinkers" should try the food, following the suggestions laid down in the book, "The Road to Wellville," found in every package.

GRAPE-NUTS 10 days will show. Fact.

There's a reason.

Underwood's Original DEVILED HAM

LOOK ON THE CAN FOR
THE LITTLE RED DEVIL

The pure and delicate Deviled Ham which has been on the market for years and years, and never found wanting. Sugar-cured ham and fine, pure spices is all that we use. It is delicious for sandwiches, at lunch, picnic, or tea, and in the chafing-dish. Our Book contains a lot of unique and practical receipts. We will send it FREE.

**UNDERWOOD'S ORIGINAL
DEVILED HAM**

may be bought at any good grocer's, but be sure you see on the can **THE LITTLE RED DEVIL.**

Wm. Underwood Co., Boston, Mass., U.S.A.

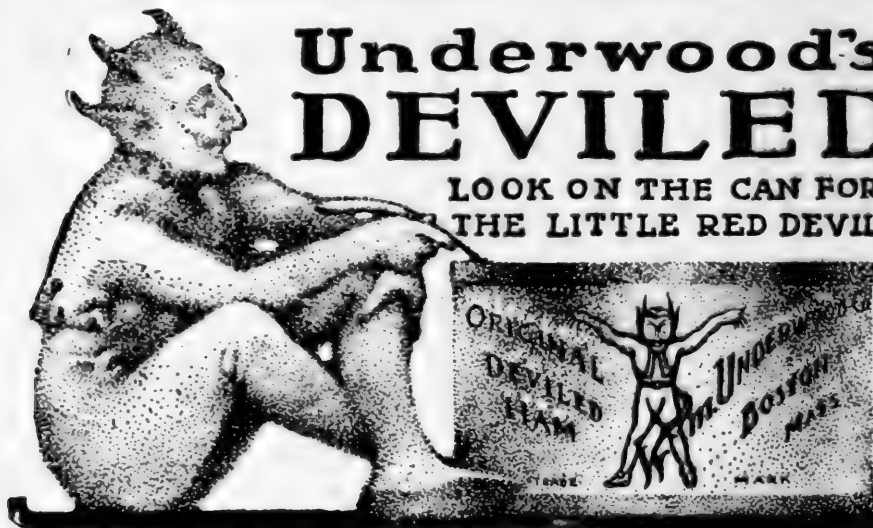

Free: If you send a new subscription to RECREATION through me or direct to the office to be placed to my credit, I will send you, free of charge, any one of the articles mentioned below:

Shot gun bench crimper, sells for 75 cents, in 10-12 16-20 gauge.

Shot gun cleaning rod, three attachments, sells for 50 cents, in 10-12 16 gauge.

Micrometer powder and shot measure, adjustable, and for both black and smokeless powder, sells for 65 cents.

U. S. Government rifle cleaner, any caliber, with attachments, sells for 60 cents, packed in neat canvas bag.

A duck, snipe or turkey call, sells for 75 cents each, best made.

A hand painted sporting picture, suitable for framing, and just the thing for your den, worth \$1.50.

"Hunting in the Great West," by G. O. Shields. H. S. Hill, 815 11th Street, N. E., Washington, D. C.

Rubbing down with methylated spirits is a most useful means of reducing harsh and over dense negatives. Cut the end of a bottle cork flat, spread wash leather or flannel on this, moisten with spirit, and rub evenly, backward and forward, the whole of the negative. The high lights will be evenly planed down and the shadows not reduced.—The Camera and Dark Room.

The Mitchell hand trap has just arrived O.K., and am sure it will be the means of my spending many a pleasant hour. I shall always feel grateful to you for giving me so much for so little.

A. A. Aukency, Hagerstown, Md.

First Shade (in Hades)—Br-r-h! What makes it so cold to-day? The fire is almost out!

Second Shade—That is because they have decided to use for fuel only those publishers who didn't lie about the sale of their books.

But I didn't know there were any here. There aren't.—*Life.*

I am in receipt of the Laughlin fountain pen sent me as a premium for 2 subscriptions to your most interesting magazine. It is a handsome pen in every respect, and I am highly pleased with it. Please accept my sincere thanks for it.

E. W. Stevenson, Govanstown, Md.

Do you want a Good, Reliable,
Substantial, Well Made

Single Barrel Shot Gun

If so, send me

10 YEARLY SUBSCRIPTIONS

and I will send you such a
Gun as a premium

It is made by the *DAVENPORT ARMS CO.*, and this means it is made of good material and that only good workmanship is put on it.

This is one of the many remarkable opportunities *RECREATION* is offering to men and boys to fit themselves out completely for shooting and fishing.

Sample Copies for Use in Canvassing
Furnished on Application.

Address

RECREATION

23 W. 24th St., New York City.

How It Looks



How It Works

Cool, Clean,
Dry Smoke

without poisonous nicotine to injure
health, or old-pipe odor to cling to clothing

MAY BELLE Sourman's
New Era PIPE

is so made that it removes the nicotine and collects it in an absorbent. Easily cleaned, always sweet and healthful. \$1.00 by mail. With amber stem \$2.50. Money cheerfully refunded if not entirely satisfactory. Free Booklet A-12.

NEW ERA PIPE CO., Norristown, Pa.

CRYSTAL Domino SUGAR



A
Triumph
in
Sugar
Making!

Sold only in 5 lb. sealed boxes!

Convenient in form, perfect in quality, brilliant in appearance, no sugar made can equal it in excellence. Every piece sparkles like a cluster of diamonds, the result of its perfect crystallization. You will be pleased the moment you open a box. **YOU WILL BE BETTER PLEASSED WHEN YOU HAVE TRIED IT IN YOUR TEA, COFFEE, ETC.**

SOLD BY GROCERS EVERYWHERE.

Remember that each package bears the design of a "DOMINO" MASK, "DOMINO" STONES and the names of the manufacturers (HAVEMEYERS & ELDER, New York). **INSIST UPON HAVING THE GENUINE.**

A VENANGO COUNTY DEER HUNT.

One Friday, late in November, it snowed, and 3 tenderfeet decided to hunt for deer the next day. Saturday morning found us starting for a 6 mile tramp to the deer woods of Venango county, Pennsylvania. We were tempted to take hounds along for their "ow-w-w, wow-w-wow-w-w" on a trail is certainly music; but hunting deer with dogs is against our law and a live dog in the deer woods here is a dead dog before he goes far. In fact, any of our hunters would let a deer pass unharmed in order to make sure of the dog behind it.

On our way to the woods we picked up a guide who knew the runs and crossings. Soon after we reached the hunting ground we came across the track of a deer. We followed the trail 2 hours and came to where the animal had lain down and then back tracked. There we separated. I had not gone far before I heard the crack of a rifle. I jumped on a stump expecting to see a deer bounding through the brush, but all was quiet. Hastening in the direction of the shot, I soon found my partner bleeding his game—a 4-pronged buck that weighed a few pounds over 100 when dressed.

We hung our deer up and hunted all day with never a sight of another except one which fell to the guns of other hunters. We had a hard time carrying our prize through the wood and over a hill before we came to a road.

F. A. Ross, So. Oil City, Pa.



Club Cocktails

Famous the world over for purity. They never vary. The secret of their perfect blend is that they are kept six months before being drawn off and bottled. Be sure you have them in your camp, on the yacht, and on your outing trips wherever you go. They are ready and require no mixing. Simply pour over cracked ice.

For Sale by all Fancy Grocers and Dealers

G. F. HEUBLEIN & BRO.
29 BROADWAY, N. Y. HARTFORD, CONN.

Stopping Stopping

Is where you save time, bother, danger and work.

The Gillette Safety Razor

Always sharp, always ready to use. Guaranteed to shave all faces, adjust, nothing to learn—simply shave. Twenty double-edged blades will give an average of twenty smooth, satisfactory shaves. When one gets dull put in another, when all are dull we sharpen and return them all ready to use for fifty cents. Forty edges ready to shave with and no work to get the four hundred shaves. No guards to fasten, no pulling, no scraping. You can shave yourself in the time used to reach the barber shop, and you take no health risks. Write for free descriptive booklet. Sold direct if not carried by your dealer. Money refunded if you are not satisfied after thirty days' trial. References: Continental National Bank, Chicago; Dun and Bradstreet Agencies.

GILLETTE SALES COMPANY, - - 1211 MANHATTAN BUILDING, CHICAGO.



Saves Time and Money

**No Stopping
No Honing**

MOJAVE INDIAN BEAD WORK.

For each new yearly subscription to RECREATION sent us we will send by mail, postpaid, a Beaded Watch Fob, made by the Mojave Indians. For 3 new yearly subscriptions we will send a fine Beaded Belt, 24 inches or more in length and made in beautiful design with mild color combinations. We also have other Indian work to offer for subscriptions.

State color desired; can furnish almost anything from large stock.

Mojave Indian Trading Co.,
Mellen, Mohave Co., Arizona.

Lady—How dirty your face is, little boy!
Boy—Yes'm; we ain't had no company for more'n a week.—Illustrated Bits.

To renovate worn leather, dissolve a little nigrosin aniline dye in alcohol, and mix it with a thin shellac varnish. Apply this with a soft brush to the leather, and, when dry, polish it lightly with beeswax and turpentine.—Photo News.

Success to RECREATION. *Keep after the hogs.* You are doing a world of good, and all good men are with you in spite of the Marlins, the Peters, the Winchesters, and the game and fish hogs.

W. W. Gallaher, Mound City, Mo.

I received the Harrington & Richardson gun, and find it is even better than you claim it to be.

F. E. Alter, Fort Wayne, Ind.

A Fountain Pen

has become a necessity with every business man. You can get a

Laughlin Fountain Pen

Made by the Laughlin Manufacturing Co.
Detroit, Michigan

For 2 Yearly Subscriptions to RECREATION

And you can get these 2 subscriptions in 20 minutes, any day.

The Laughlin is one of the best pens in the market, and thousands of them are in daily use.

There is no reason why you should be without one.

Sample Copies of Recreation for Use in Canvassing
Furnished on Application



LIQUID COURT PLASTER

Heals Cuts, Abrasions, Hang-Nails, Chapped and Split Lips or Fingers, Burns, Blisters, Etc. Instantly Relieves Chilblains, Frosted Ears, Stings of Insects, Chafed or Blistered Feet, Callous Spots, Etc., Etc.

A coating on the sensitive parts will protect the feet from being chafed or blistered by new or heavy shoes.

Applied with a brush and immediately dries, forming a tough, transparent, colorless waterproof coating.

Sportsmen, Motorists, Golfers, Mechanics, Etc.

are all liable to bruise, scratch or scrape their skin. "NEW-SKIN" will heal these injuries, will not wash off, and after it is applied the injury is forgotten, as "NEW-SKIN" makes a temporary new skin until the broken skin is healed under it.

EACH
Pocket Size (Size of Illustration), 10c.
Family Size, - - - - - 25c.
2 oz. Bottles (for Surgeons and Hospitals), - - - - - 50c.

At the Druggists, or we will mail a package anywhere in the United States on receipt of price.

Douglas Mfg. Co.

90-102 Church St.
Dept. W, New York.

AN EXTRAORDINARY BARGAIN

600 Special Ostermoor Mattresses

EXTRA WEIGHT AND THICKNESS—the exceptionally luxurious kind—recently completed by us under contract for a large apartment hotel at \$25.00 each—will be sold at a sacrifice. Sudden destruction of hotel by fire delays delivery indefinitely—we need the room for regular stock—necessity, therefore, compels us to dispose of them at once, and we offer them, while they last, at the extraordinary price of \$18.50 each.



The mattresses are all full double bed size, 4 feet 6 inches wide, 6 feet 4 inches long, in two parts, with round corners.

They are full five-inch border, with Imperial Double Rolled Edges, exactly like photographic illustration.

The filling is especially selected sheets of Ostermoor Patent Elastic Felt, all hand laid, and closed within ticking entirely by hand sewing. Mattresses weigh 60 lbs. each, 15 lbs. more than regular, and are naturally far softer and more luxuriously comfortable.

The covering is of the beautiful Mercerized French Art Twills, in pink, blue or yellow (or stripes in linen effect); also plain, narrow blue and white. The mattresses are made up in the daintiest possible manner by our most expert specialists. They represent, in the very highest degree, the celebrated OSTERMOOR merit of excellence, and are a rare bargain both in price and quality.

Price \$18.50 Each

We pay Transportation Charges anywhere in the United States.

Only while they last; first come, first served.

The opportunity to secure same is limited.

Terms of sale: Cash in advance; none sent C. O. D.

NOTE:—Ostermoor Mattresses, regular stock, same size, two parts, cost \$15.50 each. They have four inch border, weigh 45 lbs., and are covered with A. C. A. Ticking. These special Mattresses cost \$30.00 each, finish nearly two inches thicker, weigh 15 lbs. more, have round corners—Imperial Stitched Edges—close diamond tufts—and beautiful Mercerized Art Twill covering—and are far softer, and much more resilient. If you wish to know more about the "Ostermoor," send your name on a postal card for our free book, "The Test of Time" whether you intend to purchase or not.



OSTERMOOR & CO., 114 Elizabeth Street, New York.

When ordering, please state first, second, and even third choice of color of covering, in case all you like are already sold, as there will be no time for correspondence.

A VALUABLE PRESENT

**For Your Wife, Your Mother, Your
Sister or Your Best Girl**

For **25** Yearly Subscriptions to RECREATION, I will send you a set of

1 DISH AND 12 TOMATO PLATES

made by Higgins & Seiter, 50 West 22d Street N. Y. Listed at \$19.50.



And, for **20** Yearly Subscriptions to RECREATION, I will send you a set of

12 WATERMELON PLATES

listed at \$16.50. (See illustration)

THESSE are fine, thin, white china plates, beautifully hand painted, with pictures of tomatoes and tomato vines, or watermelons and watermelon vines, in natural colors, and each set of plates is enclosed in a case made in an exact imitation of a large tomato or a watermelon.

No more beautiful or appropriate present could possibly be found for a lady than one of these sets.

You can earn one of them in a few hours, and at the same time earn the everlasting gratitude of the lady to whom you may give it.

SEND FOR PACKAGE OF SAMPLE COPIES FOR USE IN CANVASSING

Dr. SCOTT'S *ELECTRIC* HAIR-BRUSH

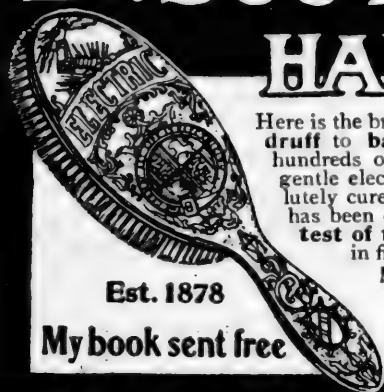

Here is the brush that will cure all scalp disorders, from **dandruff to baldness**, if conscientiously used. We have hundreds of unsolicited testimonials to that effect. The gentle electric current imparted by the brush will absolutely cure nervous headaches and neuralgia. My brush has been on the market for 26 years and has **stood the test of time**. Made from selected bristles—no wires—in five sizes and sent postpaid to any address.

No. 1, \$1.00 No. 2, \$1.50 No. 3, \$2.00 No. 4, \$2.50 No. 5, \$3.00

Prices differ only according to size and power. If not satisfactory your money will be refunded.

Dr. GEO. A. SCOTT, 870 Broadway, NEW YORK.
Agents Wanted Everywhere



Est. 1878

My book sent free

MENNEN'S BORATED TALCUM TOILET POWDER



A Positive Relief For
PRICKLY HEAT, CHAFING, and SUNBURN,
AND ALL AFFLICTIONS OF THE SKIN.

"A little higher in price, perhaps, than worthless substitutes, but a reason for it." Removes all odor of perspiration. Delightful after Shaving. Sold everywhere, or mailed on receipt of 25c. Get Mennen's (the original). Sample Free.

GERHARD MENNEN CO., Newark, N. J.

ARNICA Tooth Soap

the International Dentifrice



Beautifies the teeth, hardens the gums, sweetens the breath. Preserves as well as beautifies the teeth. Comes in neat, handy metal boxes. No powder to scatter, no liquid to spill or to stain garments.

25 Cents
At all Druggists.
C. H. STRONG & CO., Proprietors,
Chicago, U. S. A.

An Irish woman went to a photographer's and after stating that her husband was dead, requested a picture of him. On being asked for a likeness, she said:

"Shure, if I had wan picture of him, wat wud I come here for?"

The photographer, always ready for fun, replied:

"If you give me \$5 and a description of your husband, I think I can accommodate you."

"Well," answered the woman, "he had red hair, gray eyes, was tall an' 'thin an' rather narvus."

On receiving the picture, she said, with tears streaming from her eyes,

"Oh, Dennis, how you have changed!"—
Master Printer.

Brown paper is an excellent mount for warm toned matt prints. If the print is first mounted on a piece of white paper, and the edges cut to leave a white margin of about 1/4 inch, the effect is good.—Exchange.

The poor, benighted Hindoo,
He does the best he kindo;
He sticks to his caste
From first to last,
And for pants he makes his skindo.

The Suitor—They say that Love is blind.
The Heiress—But nowadays he has a marvelous sense of touch.—Life.

NERVOUSNESS Exhausted or Debilitated Nerve Force from any Cause

Cured by WINCHESTER'S SPECIFIC PILL.

It contains no Mercury, Iron, Cantharides or any injurious ingredient whatever.

This Pill is purely vegetable, has been tested and prescribed by physicians, and has proven to be the best, safest, and most effective treatment known to medical science for restoring Vitality, no matter how originally impaired, as it reaches the root of the ailment. Our remedies are the best of their kind, and contain only the best and purest ingredients that money can buy and science produce; therefore we cannot offer free samples. Price, **ONE DOLLAR** per box, **No Humbug Treatment or C. O. D. Scheme** by Sealed Mail.

PERSONAL OPINIONS: Dear Sirs: I have used a bottle of your Hypophosphites of Manganese for liver and kidney complaints in my own person and received much benefit, so I will enclose five dollars and will ask you to send me as much as you can by express prepaid for that amount, until we can get it through the regular channels. I am confident it is just what I have been in search of for many years. I am prescribing your Hypophosphites of Lime and Soda, and am pleased with the preparation. Yours sincerely,

DR. T. J. WEST,
Organic Chemistry and Physiology, New York.

Send for free treatise, securely sealed. **Winchester & Co., Chemists, 5-717 Beekman Bldg., New York.**

For Weak Lungs use Winchester's Hypophosphites. Established 1858

Deafness Can Be Cured

I Have Made the Most Marvelous Discovery for the Positive Cure of Deafness and Head Noises and I Give the Secret Free.

With This Wonderful, Mysterious Power I Have Made People Deaf for Years Hear the Tick of a Watch in a Few Minutes.

Send Me No Money—Simply Write Me About Your Case and I Send You the Secret by Return Mail Absolutely Free.

After years of research along the lines of the deeper scientific mysteries of the occult and invisible of Nature-forces I have found the cause and cure of deafness and head noises, and I am enabled by this same mysterious knowledge and power to give to every unfortunate and suffering



**I Have Demonstrated That Deafness Can Be Cured
—Dr. Guy Clifford Powell.**

person perfect hearing again; and I say to those who have thrown away their money on cheap apparatus, salves, air pumps, washes, douches, and the list of innumerable trash that is offered the public through flaming advertisements, I can and will cure you and cure you to stay cured. I ask no money. My treatment method is one that is so simple it can be used in your own home. You can investigate fully, absolutely free and you pay for it only after you are thoroughly convinced that it will cure you, as it has thousands of others. It makes no difference with this marvelous new method how long you have been deaf nor what caused your deafness, this new treatment will restore your hearing quickly and permanently. No matter how many remedies have failed you—no matter how many doctors have pronounced your case hopeless, this new magic method of treatment will cure you. I prove this to you before you pay a cent for it. Write to-day and I will send you full information absolutely free by return mail. Address Dr. Guy Clifford Powell, 730 Auditorium Building, Peoria, Ill. Remember, send no money—simply your name and address. You will receive an immediate answer and full information by return mail.

MEN, BE MANLY!



Nature intended you to be so—to be strong in mind and body, full of confidence, vim and happiness. But if you are not, and have wasted your strength causing drains, losses, varicocele, impotency, etc., nature also has a remedy for you. It is Electricity, and in my forty years' experience I have assisted nearly 100,000 weak men to regain the happy, bubbling vigor and strength that makes us men among men. Let me do so for you. My world-famed **ELECTRIC BELT** also cures rheumatism, lame back, kidney, stomach

and liver troubles, etc. Standard for forty years. Book for men, full of information, sent free, sealed. Address

DR. G. B. SANDEN

1155 Broadway

New York

Pupil—Professor, your mnemonic system is wonderful, and I am sure that any one after mastering the rules, can learn to remember anything. But I am handicapped by one difficulty.

Professor—What is it?

Pupil—I can't remember the rules.

DO YOU WISH TO IMPROVE YOUR SHOOTING? IF IT IS AS GOOD AS IT CAN BE, DO YOU WISH TO KEEP IT SO? IN EITHER CASE, THE J. C. HAND TRAP WILL BRING WITHIN YOUR REACH THE FULL ADVANTAGE OF A SHOOTING RANGE. THESE TRAPS WILL SUCCESSFULLY THROW ANY OF THE CLAY TARGETS NOW IN USE, GIVING A LIFE LIKE REPRESENTATION OF A BIRD IN FLIGHT. I WILL SEND YOU A J. C. HAND TRAP FOR 5 YEARLY SUBSCRIPTIONS TO RECREATION. SEND IN YOUR CLUB NOW, AND IMPROVE ON YOUR SHOOTING,



H. J. TILLOTSON, M. D.
The Master Specialist of Chicago, who Cures Varicocele,
Hydrocele, and treats patients personally.
Established 1880.
(COPYRIGHTED)

Varicocele Hydrocele

**Cured to Stay Cured in 5 Days,
No Cutting or Pain. Guaranteed
Cure or Money Refunded.**

VARICOCELE. Under my treatment this insidious disease rapidly disappears. Pain ceases almost instantly. The stagnant blood is driven from the dilated veins and all soreness and swelling subsides. Every indication of Varicocele vanishes and in its stead comes the pleasure of perfect health. Many ailments are reflex, originating from other diseases. For instance, innumerable blood and nervous diseases result from poisonous taints in the system. Varicocele and Hydrocele, if neglected will undermine physical strength, depress the mental faculties, derange the nervous system, and ultimately produce complicated results. In treating diseases of men I always cure the effect as well as the cause. I desire that every person afflicted with these or allied diseases write me so I can explain my method of cure, which is safe and per-

manent. My consultation will cost you nothing, and my charges for a perfect cure will be reasonable and not more than you will be willing to pay for the benefits conferred.

Certainty of Cure is what you want. I give a legal guaranty to cure or refund your money. What I have done for others I can do for you. I can cure you at home

Correspondence Confidential. One personal visit at my office is preferred, but if it is impossible for you to call, write me your condition fully, and you will receive in plain envelope a scientific and honest opinion of your case, free of charge. **My home treatment is successful.** My books and lectures mailed free upon application.

H. J. TILLOTSON, M. D., 140 Tillotson Bldg, 84 Dearborn St., CHICAGO

A Washington hostess invited an attaché of one of the foreign legations to dine with her. The invitation was formally accepted, but on the morning of the appointed day a note, written by the foreigner's valet, was received, which read:

"Mr. Blank regrets that he will not be able to be present at Mrs. Swift's dinner tonight, as he is dead."—Philadelphia Ledger.

The Savage rifle arrived safe. I am well pleased and can not thank you enough for it. It is a perfect beauty and every one who has seen it thinks so. Who would not work for RECREATION?

William Burgess, Bryn Mawr, Pa.

He killed the noble Mudjokivis;
With the skin he made him mittens,
Made them with the fur side inside,
Made them with the skin side outside;
He, to get the warm side inside,
Put the inside skin side outside;
He, to get the cold side outside,
Put the warm side, fur side inside;
That's why he put the fur side inside;
Why he put the skin side outside,
Why he turned them inside outside.

—Exchange.

I am a RECREATION fiend, and there are plenty of others here. Whatever you do, *soak it to the game hogs.*

Otto Turner, Pendleton, Ore.

TO FAT PEOPLE

I know you want to reduce your weight, but probably you think it impossible or are afraid the remedy is worse than the disease. Now, let me tell you that not only can the obesity be reduced in a short time, but your face, form and complexion will be improved, and in health you will be wonderfully benefited. I am a regular practicing physician, having made a specialty of this subject. Here is what I will do for you: First, I send you a blank to fill out; when it comes, I forward a five weeks' treatment. You make no radical change in your food, but eat as much or as often as you please. No bandages or tight lacing. No harmful drugs nor sickening pills. The treatment can be taken privately. You will lose from 3 to 5 pounds weekly, according to age and condition of body. At the end of five weeks you are to report to me and I will

send further treatment if necessary. When you have reduced your flesh to the desired weight, you can retain it. You will not become stout again. Your face and figure will be well shaped, your skin will be clear and handsome, you will feel years younger. Allment of the heart and other vital organs will be cured. Double chin, heavy abdomen, flabby cheeks and other disagreeable evidences of obesity are remedied speedily. All patients receive my personal attention, whether being treated by mail or in person; all correspondence is strictly confidential. Treatment for either sex. Plain sealed envelopes and packages sent. Distance makes no difference. Satisfaction guaranteed. Send for my new book on obesity; its cause and cure;—it will convince you. Address

HENRY C. BRADFORD, M. D., 24 East 23d Street, N. Y.

Sent on Approval

TO RESPONSIBLE PEOPLE

Laughlin

Fountain Pen

Guaranteed Finest
Grade 14k.
SOLID GOLD PEN.

To test the merits of

RECREATION

as an advertising medium
we make this grand special offer, your choice of

These
Two
Popular
Styles
For Only

\$1.00

Postpaid
to any
Address

(By Registered mail 8 cents extra)

Holder is made of finest quality hard rubber, in four simple parts, fitted with very highest grade, large size 14k, gold pen, any flexibility desired—in feeding device perfect.

Either. Style—**RICHLY GOLD MOUNTED** for presentation purposes, \$1.00 extra.

Grand Special Offer

You may try the pen a week; if you do not find it as represented, fully as fine a value as you can secure for three times the price in any other make, if not satisfactory in every respect, return it and we will promptly refund your money.

Illustration on left is full size of Ladies' style; on right, Gentlemen's style. Lay this RECREATION Down and Write NOW.

Safety Pocket Pen Holder sent free of charge with each Pen.

ADDRESS :

Laughlin Mfg. Co.

424 Griswold St., DETROIT, MICH.

From "Macey" to You
Grand Rapids, Mich.

We save you from 25% to 40% on fine Office and Library Furniture. We manufacture the goods we sell. We guarantee quality and prices satisfactory.



No. 10 H Office Desk

48 in. long by 30 in. wide; with file boxes and letter files complete as illustrated. Quarter-sawed oak front; balance of desk plain oak golden polish finish. Price **\$19.80**

Other roll top desks up to \$300.00. Ask for desk catalogue No. 2—mailed free.

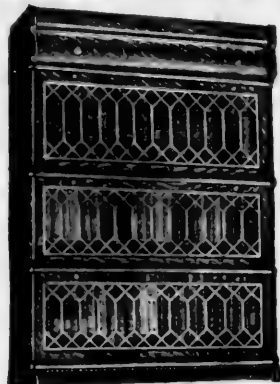

Sectional Bookcase

49 in. high; 34 in. wide; 9½ in. deep inside. Quarter-sawed oak, art glass doors, drawer base, **\$18.25**

Plain glass, no drawer—\$13.50. Ask for catalogue No. 1—mailed free.

We prepay freight east of Mississippi River and north of Tennessee (points beyond on equal basis).

THE FRED MACEY CO., Ltd., GRAND RAPIDS, MICH.
Dept. LL3, 1300-1320 Division St.

DO YOU WANT A LENS?

If so, why not get a good one?
And why not get it free of charge?
This is easy.

Any old box will answer the purpose if it does not leak light; but you must have a fine lens to make a fine picture.

You can get

**A Royal Anastigmat
Lens, 4x5, Series No. 1,**

Made by the Rochester Lens Co., Rochester, New York,

**And listed at \$45,
For 20 yearly subscriptions
to RECREATION.**

You can get any other lens made by this Company on a basis of one subscription to \$2. of the list price of the lens.

Sample copies of RECREATION for use in soliciting furnished on application.

FRENCH — GERMAN — SPANISH

LANGUAGE-PHONE METHOD

Combined with DR. RICHARD S. ROSENTHAL'S METHOD OF PRACTICAL LINGUISTRY

No longer unnecessary memorizing of verbs, declensions or rules. You hear the exact pronunciation of each word and phrase thousands of times if you like. It requires but a few minutes' practice in spare moments to acquire a thorough mastery of conversational French, German or Spanish. College professors all over this and other countries, and the press generally, endorse this perfect and natural system of teaching languages. Send for testimonials, booklet, and letter telling all about this 20-century scientific marvel.

INTERNATIONAL LANGUAGE-PHONE METHOD, 1116 Metropolis Bldg., B'way & 16th St., N. Y.

NOW DEPOSITED IN THE BANK

\$75,000.00

IN CASH GIVEN AWAY.

To arouse interest in, and to advertise the **GREAT ST. LOUIS WORLD'S FAIR**, this enormous sum will be distributed. Full information will be sent you **ABSOLUTELY FREE**. Just send your name and address on a postal card and we will send you full particulars.

World's Fair Contest Co.,
108 N. 8th Street
St. Louis, Mo.

WOULD YOU ACQUIRE

Manly Bearing
Erect Carriage
Grace and Elegance of Movement
Perfect Muscular Development

If so take a course of training in

THE NEW METHOD OF FENCING

as taught by

LIEUT. J. MARCZI DE ZOLDY
Late of the 25th Regiment, Austro-Hungarian Army.

STUDIO :
489 Fifth Avenue, New York City
Write for terms and full information

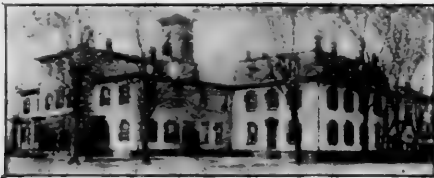

New Jersey
Military Academy
Freehold, New Jersey

\$400 per year.
For Catalogue, address the Principals
Col. C. J. WRIGHT, A. M., WALTER HEWETSON, A. B.

Free:—I will give anybody sending me 1 subscription or renewal, any one of the articles named below:
Ideal Shell Closer, 10-12-16 gauge, sells for 50c.
Ideal Shell Loader, 10-12-16 gauge, sells for 50c.
Perfection Gun Oiler, can not spill when not in use, worth 50c.
Web Shot Shell Belt, 10-12-16 gauge, sells for 75c.
Henry B. Floyd, 723 Eighth St., N. W. Washington, D. C.

IN ANSWERING ADS. PLEASE MENTION RECREATION.

Copies of Master Paintings

AN OFFER SAVING OVER HALF

After supplying our members and patrons we have left on hand a few sets of our superb copies of famous paintings done in carbon-tint. We have decided to use these sets of ten pictures as a means of bringing us in touch with art-lovers and persons who appreciate artistic things generally.

The complete set, at once, will be
Sent on Approval

After the pictures are received and found satisfactory send

\$1.00

and \$1 a month thereafter for 5 months.

Each subject is prepared for framing on mounts especially made for them or can be used as they are, unframed, a custom now much in vogue. They make splendid gifts for weddings or birthdays. Inferior copies sell in art shops for \$5 each copy.

Rec. 1
Art Lovers' Society
1136 Broadway
New York

Send on approval Set of Ten Copies of Master Paintings and Five Pasto-Carbon Proc.s. If satisfactory, I agree to pay \$1 within five days, and \$1 a month thereafter for five months. If not satisfactory, will return the sets within five days.

Name.....
Address.....

List of Titles and Artists
Each, mounted, 20 x 25 ins.

1 THE MILL Ruysdale
2 SPRING Corot
3 PLOUGHING . . . Rosa Bonheur
4 THE GLEANERS . . . Millet
5 REMBRANDT . . . Rembrandt
6 DIVINE SHEPHERD . Murillo
7 SHEEP IN SNOWS STORM Schenek
8 BRUING IN THE COWS Dupre
9 DUCHESS OF DEVONSHIRE Galasborough
10 GIRL WITH THE MUFF Le Bran

FREE If you mail us the blank composite promptly, we will include in your package free of expense, 5 Additional Pictures, the gems of the Pasto-Carbon set issued last fall. Each mounted 10x24 inches. Formerly sold for \$2.50 each.

GOING into CAMP?

If so, you will need

A TENT

You can get one big enough for 4 men and their camp outfit, by sending me

8 Yearly Subscriptions to RECREATION

at \$1 each. You can get another tent big enough for 6 men by sending me

10 YEARLY SUBSCRIPTIONS

at \$1 each.

Why pay out money for a tent when you can make your friends pay for it?

Sail in and fit yourself for your summer vacation.

This is a great opportunity, and will hold good for only a few weeks.

Sample copies of RECREATION for use in canvassing furnished on application.

WANT A REEL?

You can get one for nothing.
Or at least for a few hours' work.

Send me

15 Yearly Subscriptions
to
RECREATION

and I will send you

A TALBOT REEL

Listed at \$20

Made by W. H. Talbot, Nevada, Mo.

This is one of the finest pieces of fishing tackle ever made. It is built like a gold watch. Equal to any Kentucky reel you ever saw.

**In Tournaments, Always a Victor
Among the Angler's Treasures, Always the Chief**

I have but a few of these reels in stock and this offer will be withdrawn as soon as the present supply is exhausted.

Sample copies of RECREATION for use in canvassing furnished on application.

Marks was an Irish setter dog, raised and owned at Grand Haven, Mich. Marks was a general; no man could tell him anything about hunting that he had not known for years. A wounded bird never got away, on land or water, when Marks was sent for him. He was good on quails, woodcock, snipe, and ruffed grouse. On one occasion while climbing over a rail fence he stiffened on the top rail, with the birds just on the other side. Another time he pointed at the end of a hollow log. We kicked the log and out came one bird, which was dropped. Marks brought it in, then pointed at the same place as before. We kicked again, and out came bird No. 2, closely followed by bird No. 3. No. 2 was shot, while Marks caught No. 3 and still pointed the log with a live bird in his mouth. We took 2 more from that log, making 5 birds in all.

Marks was 13 years old when he died. He will never be forgotten by those who have followed him in the field.

L. N. Van Duzer, Grand Haven, Mich.

"Miss Angeline," began the poor but proud young man, "if I were in a position to ask you to be my wife—"

"Good gracious, Mr. Throgson! In a position! The idea! Do you think I would want you to get down on your knees?"—Chicago Tribune.

When you think of the incandescent Electric Light you think of Edison. When you think of Beer as a product of the perfected science of modern brewing you think of PABST. Only the choicest hops, the richest malt and the most scrupulous care could produce such a brew as

Pabst Blue Ribbon

The Beer
of Quality



Clear as crystal, mellow in taste, and exquisite in flavor, every drop of it is filtered and every bottle sterilized. It is by common acknowledgment of experts and laymen the standard brew of America

SOME RARE OPPORTUNITIES

These goods are all new, and will be shipped direct from factory. Prices named are those at which manufacturers and dealers usually sell. Here is a good chance to get

A Book, a Gun, a Camera
A Sleeping Bag, a Fishing Rod
A Reel, a Tent, } FREE OF COST

Subscriptions need not all be sent at once. They may be sent in installments as taken and credit will be given on account. When the required number is obtained the premium earned will be shipped.

TO ANY PERSON SENDING ME

TWO new yearly subscriptions to RECREATION at \$1 each, I will send a copy of *Hunting in the Great West*, cloth; or an Ingersoll Watch or Cyclometer, listed at \$1; or a Recreation Waterproof Match Box, made by W. L. Marble and listed at 50c; or a Shakespeare Revolution Bait listed at 75c; or a Laughlin Fountain Pen; or a dozen Trout Flies, assorted, listed at \$1; or a pair of Attachable Eyeglass Temples, gold-plated, made by Gall & Lembke; or one Rifle Wick Plug, made by Hemm & Woodward, Sidney, Ohio, 30 caliber to 50 caliber, or Shotgun Wick Plug, 20 gauge up to 10 gauge, or a pair of chrome tanned horsehide hunting and driving gloves, listed at \$1.50, made by J. P. Luther Glove Co.

THREE new subscriptions at \$1 each, a safety pocket ax, made by W. L. Marble and listed at \$2.50; or a dozen Bass Flies, assorted, listed at \$2; or a pair of Shotgun Wick Plugs made by Hemm & Woodward, Sidney, Ohio, 20 gauge to 10 gauge; or a Polished Buffalo Horn Gun Rack, made by E. W. Stiles; or a pair of gauntlets, for hunting and driving, ladies' size, listed at \$2.50, made by J. P. Luther Glove Co., or a Press Button Jack Knife, made by The Novelty Knife Co., and listed at \$1.

FOUR new subscriptions at \$1 each, an Ideal Hunting Knife, made by W. L. Marble and listed at \$2.50; or a 32 caliber, automatic double action revolver, made by Harrington & Richardson Arms Co.

FIVE new subscriptions at \$1 each, a copy of *Cruisings in the Cascades*, cloth; or an Ideal Hunting Knife made by W. L. Marble, and listed at \$3; or a pair of lock lever skates, made by Barney & Berry, listed at \$4.50; or a J. C. Hand trap made by the Mitchell Mfg. Co., listed at \$4; or a Bristol Steel Fishing Rod, listed at \$6, or less; or a Yawman & Erbe Automatic Reel, listed at \$6 to \$9.

SIX new subscriptions at \$1 each, a Hawkeye Refrigerating Basket made by the Burlington Basket Co., or one dozen Eureka golf balls listed at \$4; or a Pocket Poco B 3¼ x 4¼, made by the Rochester Optical Co., listed at \$9.

SEVEN new subscriptions at \$1 each, a copy of *The Big Game of North America*, or of *The American Book of the Dog*,

cloth, or one set Lakewood golf clubs, 5 in number, listing at \$5; or a series 11F Korona Camera, made by the Gundlach Optical Co., listed at \$10.

EIGHT new subscriptions at \$1 each, A series 1, 4 x 5 Korona Camera, made by the Gundlach Optical Co., listed at \$12, or an Acme single shot gun, made by the Davenport Arms Co., and listed at \$8.

TEN new subscriptions at \$1 each, a Cut-Glass Salad Bowl, made by Higgins & Seiter, and listed at \$4.50; or a Waterproof Wall Tent 7 x 7, made by Abercrombie & Fitch, and listed at \$8; or a Rough Rider rifle telescope, made by The Malcolm Rifle Sight Mfg. Co., and listed at \$12; or a Pneumatic Camp Mattress, listed at \$18; or a pair of Opera Glasses made by Gall & Lembke and listed at \$10.

TWELVE new subscriptions at \$1 each, a Davenport Ejector Gun, listed at \$10, or a Cycle Poco No. 3, 4 x 5, made by the Rochester Optical Co., listed at \$15; or an 8 ft. folding canvas boat, made by the Life Saving Canvas Boat Co., listed at \$29.

FIFTEEN new subscriptions, \$1 each, a Shakespeare Reel, Silver Plated, listed at \$15; or a set of rabbit plates made by Higgins & Seiter, and listed at \$8; or a Field Glass made by Gall & Lembke; or a Kenwood Sleeping Bag, complete, with canvas cover, listed at \$16; or a Bulls-Eye rifle telescope, made by The Malcolm Rifle Sight Mfg. Co., and listed at \$16; or a 10 ft. special canvas boat, made by the Life Saving Canvas Boat Co., and listed at \$35; or a pair of horsehide hunting boots, listed at \$10; or a Queen Hammock, made by the King Folding Canvas Boat Co., and listed at \$15.

TWENTY new subscriptions at \$1 each, a 14-karat Gold Hunting-case Watch, with Waltham Movement, listed at \$20; or an Elita single shot gun, made by the Davenport Arms Co., and listed at \$18; or an Acme Folding Canvas Boat, No. 1, Grade A, listed at \$27; or a Mullins Duck Boat, listed at \$20; or a Queen Hammock, made by the King Folding Canvas Boat Co., and listed at \$20.

TWENTY-FIVE new subscriptions at \$1 each, A 4 x 5 Planatic lens, made by the Rochester Lens Co., and listed at \$45; or a 11-foot King Folding Canvas Boat, listed at \$38.

THIRTY new subscriptions at \$1 each, a Waterproof Tent, 14½ x 17, made by Abercrombie & Fitch, and listed at \$25.

THIRTY-FIVE new subscriptions at \$1 each, a 14-ft. King Folding Canvas Boat listed at \$48.

FORTY new subscriptions at \$1 each, a Savage .303 Repeating Rifle; or a No. 10 Gun Cabinet, made by the West End Furniture Co., and listed at \$32.

FIFTY new subscriptions at \$1 each, a No. 20 Gun Cabinet, made by the West End Furniture Co., and listed at \$38; or a Colt Automatic Pistol, made by the Colt's Patent Fire Arms Mfg. Co., and listed at \$25.

Address, **Recreation** 23 West 24th St.
New York

Fortune Knocks

ONCE AT EVERY MAN'S DOOR

Only of late has Idaho become known as a great mining state. There has been no sudden rush of gold-seekers like there was to the Klondike, but it is a fact recognized by mining experts that nowhere are greater possibilities than in the sections where the properties of the

Mammoth and Great Eastern Milling and Mining Company

are located in the heart of the great **IDAHO GOLD FIELDS** from which has been taken over \$160,000,000.00 of placer gold alone.

The rich ledges of the Mammoth and Great Eastern and Union Groups are now being developed, and the ore is strictly free-milling. The company owns these two great groups of claims, a total of 14 claims each 600x1500 ft., with every requisite for the cheap mining and milling of ore. Shafts have been sunk and several tunnels made. Assays made range from \$43.87 to \$518.22 per ton. The lowest mill run averages \$8.65 per ton on the plates (concentrates \$124.34). A new 50-ton mill will reduce the total cost of reduction to less than \$2 per ton, leaving a sure net profit of over \$300.00 per day—\$100,000.00 per year—which will be vastly increased by progressive development when the shafts and tunnels are extended to the richer ore bodies. The possibilities of the Mammoth and Great Eastern properties are almost boundless.

It is now proposed to sink a shaft on the new property 500 feet, and drift both ways on the ore shoots every 100 feet, blocking out as large a body as possible; also to install a mill at the earliest possible date with at least 50 tons per day capacity and to commence to produce bullion before January 1, 1905.

OUR PROPOSITION

We have 500,000 shares of non-assessable Treasury Stock. We are ready for the installation of a mill and anxious to produce bullion to be paid out in dividends. To obtain without delay the necessary capital for this purpose and for further development, the Board of Directors now offer a block of 100,000 shares of their Treasury Stock at



TEN CENTS PER SHARE

If subscribed and paid for on or before April 1st, 12 o'clock noon.

10 Shares \$1 100 Shares \$10 1,000 Shares \$100

After April 1st the price will be 15 cents per share; after May 1st 20 cents; after June 1st 25 cents, and after July 1st no stock will be offered at any price. The experimenting is over; the hard work is done; the golden harvest is in sight. The prompt investor will reap the benefit.

A few dollars invested now in Mammoth & Great Eastern may mean financial independence when you most need money. The investment will prove better than the best Insurance Policy. You pay but once—dividends once begun will keep on forever—and you have the use of the money while you live.

This is not a visionary scheme or a "wildcat" speculation. The pay dirt is in sight in practically unlimited quantity. There are no middle men—no commissions paid to agents—no Wall street connections—all orders for stock go direct to the company and not one dollar is paid to the officers. All money received for stock is used to develop the mine. When the mill is installed and bullion produced all the stockholders will share in the dividends.

The Directors of the Company are the best known men in one of the leading towns of the Dominion of Canada, safe and conservative men of affairs: Charles E. Monteith, President, a long time resident of Idaho and interested in several mining companies; William Gordon, Vice-President, the largest dry goods merchant in Chatham; George B. Douglas, Secretary, solicitor for The Sutherland Innis Co., Ltd., the largest Cooperage manufacturing concern in Canada; Dr. J. R. Battisby, Treasurer, the leading Presbyterian divine of Chatham. The Directory also includes James Innis, Managing Director of the Sutherland Innis Co., Ltd.; G. A. Witherspoon, proprietor of the largest drug business in Chatham, and N. H. Stevens, President of the Canada Flour Mill Co., Ltd. None of these men are professional promoters or speculators. The Superintendent, Andrew Prader, is a practical miner of fourteen years' experience and of established reputation, and has been interested in this enterprise from the beginning. These men have engaged in a legitimate enterprise—to work the mine, not the investor. This makes non-assessable stock, the proceeds of which go into development, an absolutely safe investment. **Not One Chance to Lose—A Million Chances to Win.** But prompt action is necessary to get in on the ground floor. The stock will positively advance on APRIL 1st.

Orders for stock accompanied by cash may be sent direct to the company, or to the Bank of Montreal, Chatham, Ontario, Canada. Full particulars free. Write at once for handsomely illustrated booklet giving photographic views and maps and valuable facts and figures, which will be mailed FREE on request.

**DO IT TODAY FORTUNE MAY NOT KNOCK
AT YOUR DOOR AGAIN!**

Mammoth & Great Eastern Milling & Mining Company
Chatham, Ontario, Canada

For Hunters, Anglers, Prospectors, Ranchmen, The Press Button Knife

IS THE THING.

A single pressure of the button opens it. It locks open, cannot close on the fingers, saves the finger nails, has 2 blades hand-forged from Wardlow's best English steel, and is in every respect as good a knife as can be made. Ladies' and Gentlemen's sizes in Stag Shell or Ivory handles, including moisture-proof Chamois case securely mailed to any address for **75 CENTS**,

Send for catalogue K for description and prices of other styles.

**THE
NOVELTY
KNIFE CO.**

426 East 52d Street,
NEW YORK.

And all others who go
into the Woods or Hills

Our 5-inch Press Button Hunting Knife can not be excelled. Can be opened with one hand, and will not open or close accidentally.

Handsome Stag Handle

Price, One Dollar

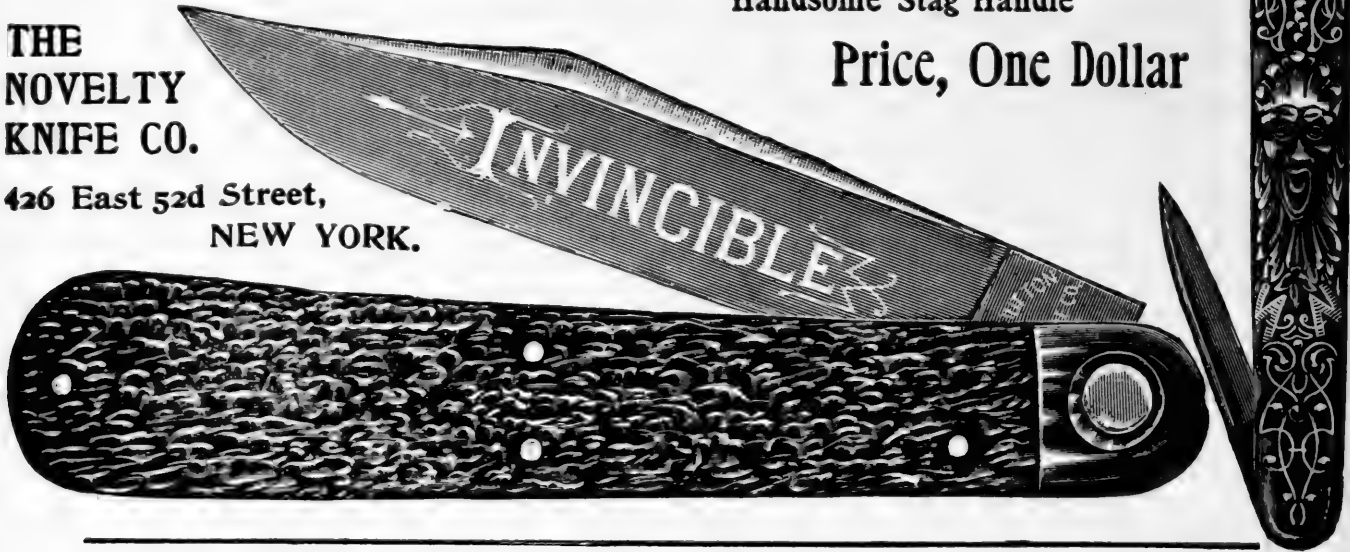

Going Fishing?

Well fixed for rods? If not,
send me 5 yearly subscriptions to

RECREATION

and get a Bristol Steel Rod—
any one listing at \$6.00 or less.

Everybody knows what a Bristol
Steel Rod is. It is equal in
strength, durability, suppleness,
and all the other good qualities to a
split bamboo rod costing \$20.

Sample copies of RECREATION for use in canvassing furnished on application

THE Keeley Cure

**Alcohol,
Opium,
Tobacco
Using ***

Produce each a disease having definite pathology. The disease yields easily to the Treatment as administered at the following Keeley Institutes:

ALWAYS ADDRESS THE INSTITUTE NEAREST TO YOU.

Birmingham, Ala.	Crab Orchard, Ky.	Fargo, N. D.	Columbia, S. C.
Hot Springs, Ark.	New Orleans, La.,	North Conway, N. H.	Dallas, Tex.,
Los Angeles, Cal.	1628-38 Felicity St.	White Plains, N. Y.	Bellevue Place.
San Francisco, Cal.	Portland, Me.	Columbus, O.	Richmond, Va.
1170 Market St.	Lexington, Mass.,	Cor. 3rd and	Seattle, Wash.
West Haven, Conn.	Grand Rapids, Mich.	Dennison Aves.	Huntington, W. Va.
Washington, D. C.,	St. Louis, Mo.	Portland, Ore.	Waukesha, Wis.
211 N. Capitol St.	2803 Locust St.	Harrisburg, Pa.	Toronto, Ont.
Dwight, Ill.	Boulder Hot Springs,	Philadelphia, Pa.,	Winnipeg, Man.
Charlestown, Ind.	Boulder, Mont.	812 N. Broad St.	London, Eng.
Marion, Ind.	Omaha, Neb.	Pittsburgh, Pa.,	Cape Town, S. A.
Des Moines, Ia.	724 S. 19th St	4246 Fifth Ave.	
	Buffalo, N. Y.	Providence, R. I.	

Rev. T. DeWitt Talmage's famous lecture, "Evils of Intemperance," mailed on application. **LESLIE E. KEELEY, M.D., LL.D.**



At present, July, October, November and December are open season for woodcock in New Jersey. The open season for rabbits, quail, grouse and squirrels is November 10 to December 1. Without exaggeration, there are almost as many rabbits, squirrels and birds killed during October as during the legal season, by persons ostensibly hunting woodcock. I have heard guns discharged in places where I am certain no woodcock existed, and have seen a man shooting quails in August. This condition of things is generally known, but because of the open season for woodcock it is next to impossible to catch violators of the law. I wish someone would suggest a practical remedy. I promise to do my part. Perhaps a letter to our representatives at the State Capital would do some good.

Jos. E. Kelly, New Market, N. J.

**MEXICAN OPAL AND SOMBRERO
FREE WITH EACH SUBSCRIP-
TION TO RECREATION.**

To anyone sending a new subscription for RECREATION through me, I will send free a beautiful, genuine Mexican Opal as large as a pea, together with a miniature Mexican Sombrero, made of silver and horsehair beautifully dyed. Arthur Thomson, Box 332, San Antonio, Texas.

Avoid Wrinkles by Using



A Stallman Dresser Trunk

**KEEPS YOUR CLOTHING
FLAT AND SMOOTH**

Everything in reach. No heavy trays, but light, easy running drawers. Holds as much and costs no more than a good box trunk. Hand riveted, almost indestructible. Once tried, always recommended. Sent C. O. D., privilege examination. 2c stamp for catalogue. Mention RECREATION.

F. A. STALLMAN

87 W. Spring St.

Columbus, O.

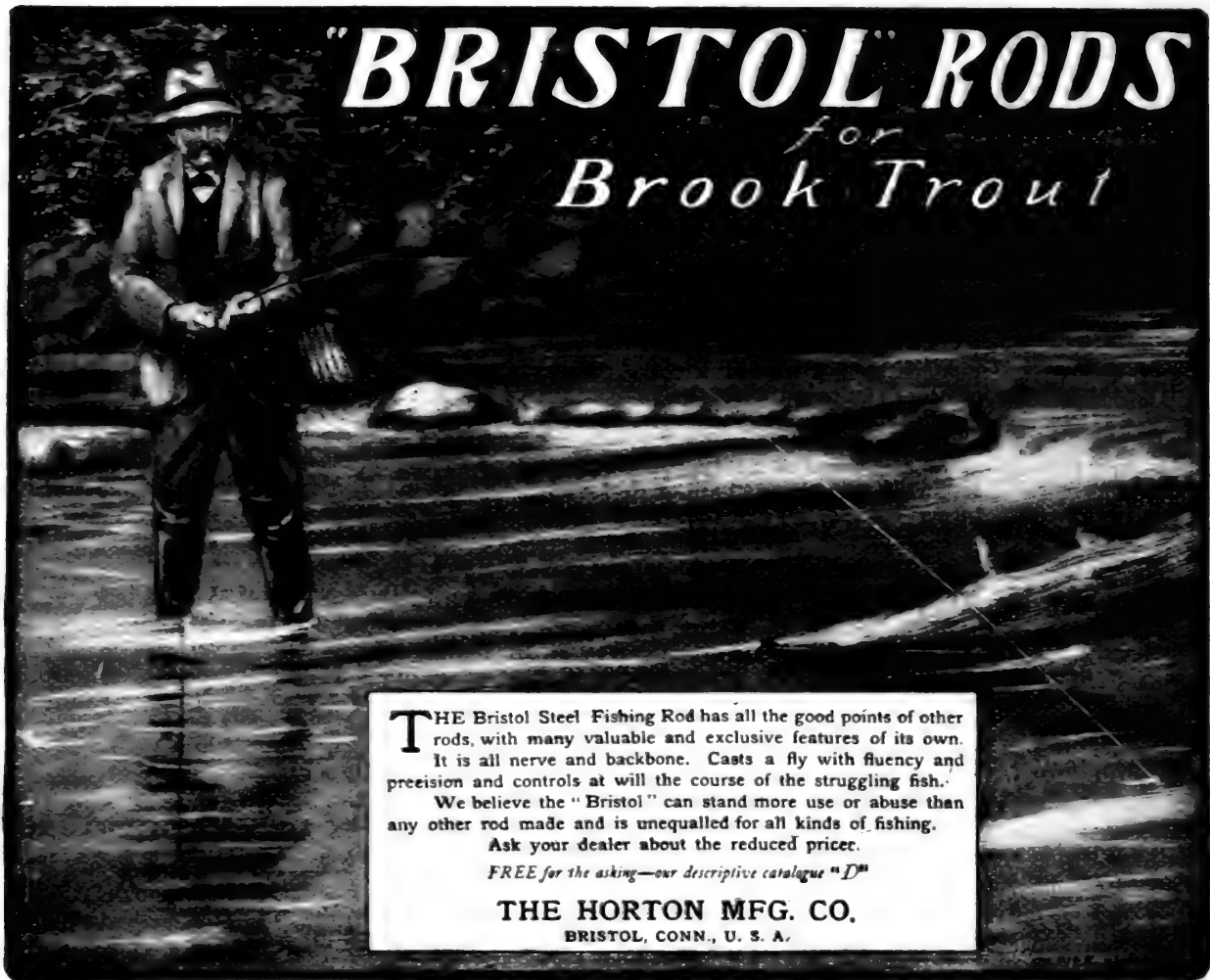

"BRISTOL" RODS

for
Brook Trout

THE Bristol Steel Fishing Rod has all the good points of other rods, with many valuable and exclusive features of its own. It is all nerve and backbone. Casts a fly with fluency and precision and controls at will the course of the struggling fish. We believe the "Bristol" can stand more use or abuse than any other rod made and is unequalled for all kinds of fishing. Ask your dealer about the reduced price.

FREE for the asking—our descriptive catalogue "D"

THE HORTON MFG. CO.
BRISTOL, CONN., U. S. A.

Small Profits—Quick Sales

TROUT FLIES

for trial—send us



- | | | |
|-----|--|-----------------|
| 15c | for an assorted sample doz. Regular price, 24 cents. | Quality A Flies |
| 30c | for an assorted sample doz. Regular price, 60 cents. | Quality B Flies |
| 60c | for an assorted sample doz. Regular price, 84 cents. | Quality C Flies |
| 60c | for an assorted dozen Regular price 84 cents. | Bass Flies |

SPLIT BAMBOO RODS

Fly Rods 10 feet, 6 ounces **57 cents** Bait Rods 9 feet, 8 ounces
With cork grip and extra tip, in wood form

THE H. H. KIFFE CO.
523 Broadway, New York City

Catalogs of any of above goods free on application.
Mention RECREATION.

Are You an Amateur Photographer?



If so, would you like a Camera that will photograph

- A whole range of mountains
- A whole sweep of river
- A whole army
- A whole fleet of ships
- A whole city

Or any other vast stretch of scenery or moving objects? THE SWING LENS DOES IT.

The AL VISTA

Is the thing

One of the greatest inventions of the age.

I will give you a No. 5-B as a premium for 12 subscriptions. For particulars address

Recreation, 23 West 24th St. New York City

Fisk's Aerating Minnow Pail



The only Minnow Pail in which minnows can be kept alive indefinitely.

Has an air chamber at the bottom holding 26 cubic inches of condensed air forced in by the Air Pump attached, and by a simple rubber attachment the air is allowed to escape into the water gradually supplying the fish with the oxygen consumed by them.

One pumping is sufficient for ten hours. Height, 1 foot; diameter 10 inches; weight, 7½ lbs.; water, 2½ gallons; keeps 50 to 150 minnows, according to their size.

IT KEEPS THEM ALIVE.

Price, \$5 Net. Sold direct

Send for circular. Mention RECREATION.

J. M. KENYON & CO.

214 Twelfth St., Toledo, Ohio, U.S.A.



The Comfort Back

adjusts itself with the rise and fall of the shoulders. Gives ease—takes strain.

PRESIDENT SUSPENDERS

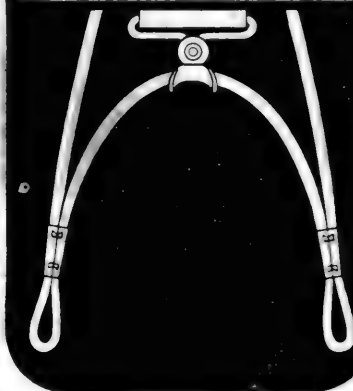

Satisfaction, a new pair or your money back. Metal trimmings cannot rust—no leather to soil the shirt.

For summer comfort ask for the **LIGHTWEIGHT PRESIDENT**

Price 50c and \$1.00 any store or mailed.

THE C. A. EDGARTON MFG. CO., Box 311, Shirley, Mass.

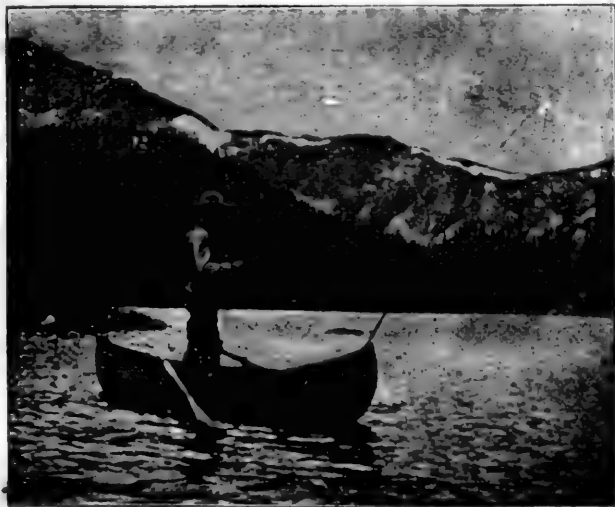

11-foot Special

used by the U. S. Navy. They are simple, wonderful. A thoroughly patented article. Beware of imitations. Made only by ourselves. *A catalog of 100 engravings and 400 testimonials sent on receipt of 6 cents.*

Bottom Boards rest on the frame, not on the canvas, ribbed longitudinally and diagonally. They are *stiffer and safer* than a Wooden Boat because the lines are fuller, and are much easier to row or paddle.

KING FOLDING CANVAS BOAT CO.

Mention RECREATION.

KALAMAZOO, MICH., U. S. A

Folding Canvas Boats

were not satisfactory until the

KING

was produced. It's a revelation in boat construction, nothing like it ever made. *Nonsinkable Can't tip over. Puncture Proof, wear longer than a wooden boat. No repairs. No cost for storage, always ready, folds into a small neat package, carry by hand,*

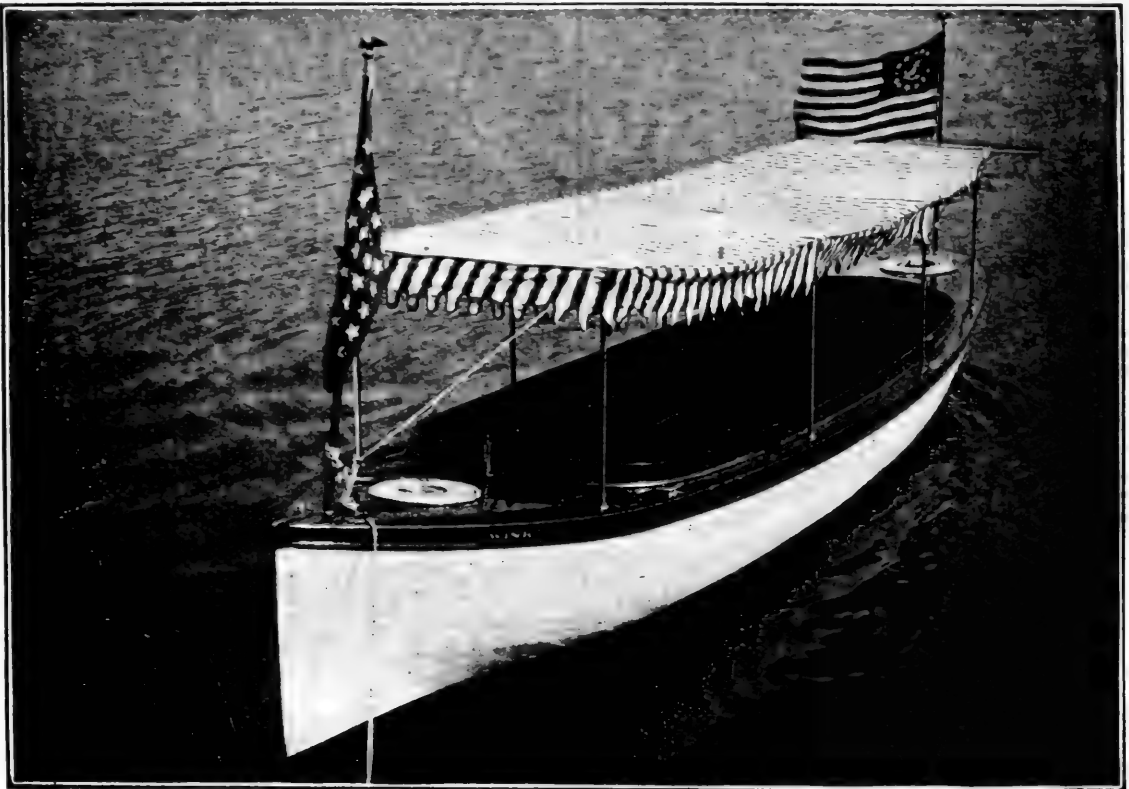

GASOLINE ENGINES and LAUNCHES UP TO DATE
 Self-Starting Jump or Break Spark Catalog Free
D. M. Tuttle Co. Pine Street ¹⁰ Canastota, N. Y.

A Press Button Hunting Knife

Is one of the best articles a hunter ever carried

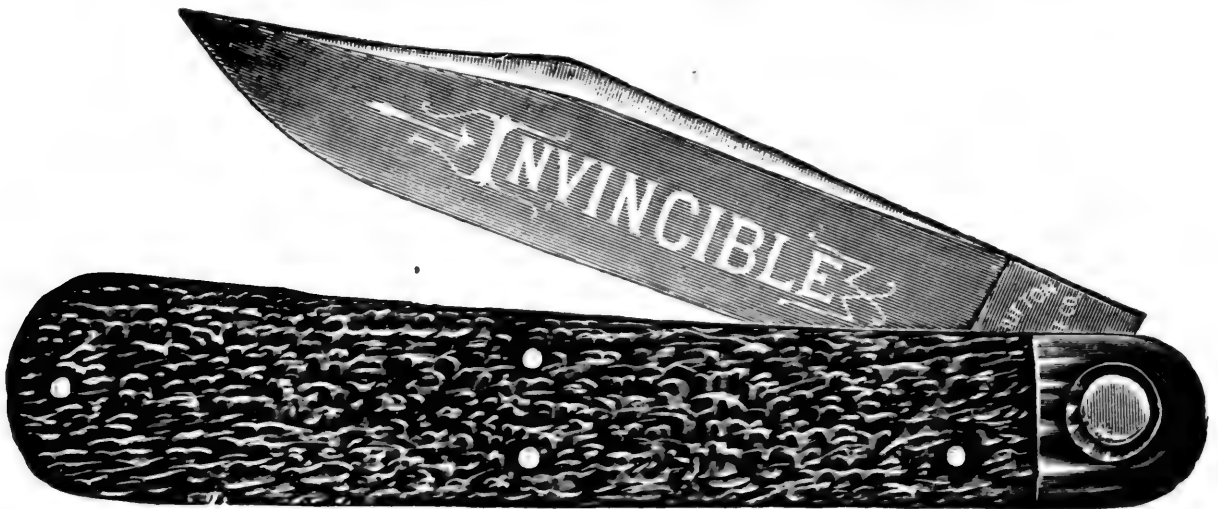

It has a 4 Inch Blade made of the Best Silver Steel

The knife cannot come open in your pocket. It cannot close on your hand when in use. It opens and closes only when

YOU PRESS THE BUTTON

If you once use one of these knives you will never use any other. You can get one as a premium for

3 YEARLY SUBSCRIPTIONS TO RECREATION

Sample Copies furnished on request.



If you want both style and durability get a

Matthews Torpedo Launch

Built after the most approved models.

Any power or motor desired installed.

Send for our free booklet of **MARINE LAWS AND TABLES.**

Send 10c for catalogue.

Mention **RECREATION**

Matthews Boat Co.

BASCOM, OHIO, U. S. A.

"We will never give up," said the South American military leader.

"Give up what?" asked the coldly practical man.

After a moment of reflection, the military leader candidly replied: "Anything we can get our hands on."—Washington Star.

I enjoy reading **RECREATION** more than any other magazine I ever saw.

Geo. Hayden, Jacksonville, Ill.



CANOES and ROW BOATS

Canvas-covered, built of cedar, light, staunch, graceful. Made of best materials by skilful workmen. Styles for all purposes; wide range of sizes and prices. Send **Now** for free illustrated catalogue.

OLD TOWN CANOE CO., 28 Middle St., Old Town, Me.

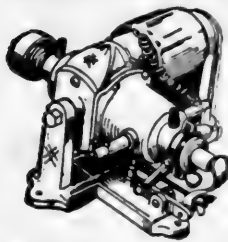

TO OWNERS OF GASOLINE ENGINES, AUTOMOBILES, LAUNCHES, Etc.

The **Auto-Sparker**

does away entirely with all starting and running batteries, their annoyance and expense. No belt—no switch—no batteries. Can be attached to any engine now using batteries. Fully guaranteed; write for descriptive catalog.

Motsinger Device Mfg. Co.
75 Main St., Pendleton, Ind.

SMALLEY

MARINE GAS ENGINES

Designed for use in any kind of a boat requiring from 1½ H. P. to 20 H. P. Either single or double cylinder. Simple, mechanical, handsome, durable, positive, economical, and moderate priced. Our speed control, propeller equipment, and many other features should be investigated. **OUR NEW PLANT** is the largest in the world devoted exclusively to the manufacture of Marine Gasoline Engines. We operate our own pattern, foundry, forge, and machine departments. We manufacture every part of our engines, from fly wheel to propeller.

Every engine is connected to its propeller and given an actual water test before placed in purchaser's hands.

SEND FOR ILLUSTRATED CATALOGUE. ADDRESS DEPT. C
Smalley Motor Co., Ltd., Bay City, Mich., U.S.A.

She—You'd better sit by this open window, dearest, in case papa should come into the room suddenly.

He—But there's a fierce bulldog outside, darling.

"I know it. But of 2 evils, always choose the lesser."—Exchange.

Wanted—First-class rod maker who understands the business thoroughly. Address Wm. Shakespeare, Jr., Kalamazoo, Mich.

THE TEST OF TIME

has proven the superiority of the

Iowa Marine Engine

OVER ALL OTHERS

Has record of 86,400 miles in four seasons and still in service. Send 8 cents for descriptive catalogue. Mention **RECREATION**.

Iowa Marine Engine Works

BELLEVUE, IOWA

EASIER TO ROW

ABSOLUTELY SAFE

Write today for free catalogue

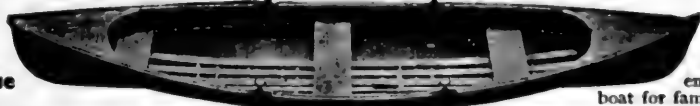

15 foot boat, crated \$29.00

Especially valuable at summer resorts, for family boating.

Mullins Galvanized Steel Pleasure Boats

Made of steel. Practically indestructible. Air chamber each end. Cannot sink. Cannot leak. Require no caulking. Ideal boat for family use, summer resorts, parks. Guaranteed. Will seat five persons in comfort. The modern row-boat for pleasure, safety and durability.

W. H. MULLINS, 228 Depot Street, Salem, Ohio

The Western Recreation Launch

For those who want the best.



Absolute Launch Satisfaction

Is contained in the "Western Recreation." It possesses those essential points, Grace, Beauty of Outline, Symmetry, Simplicity and Safety. Speed is there too if you want it. Most reasonable in first cost, most economical to maintain.

The Best Finished, Handsomest, Most Reliable.

We build them with either Torpedo or Semi-Elliptical Hulls, and, in completeness, it is the ideal and dependable craft for pleasure and security.

THE WESTERN MARINE ENGINE

WILL PLEASE THOSE WHO BUILD THEIR OWN HULLS.

Beautiful Art Catalog describing our Launches and Marine Engines will be sent upon receipt of Ten cents. Write for Catalog L.

Western Launch and Engine Works,
No. 12 Linn St.
MISHAWAKA, IND.

The Peerless TRUSCOTT

Any thing from a ROW BOAT to the 100-foot YACHT

GASOLINE OR ELECTRIC POWER

AUTO BOATS AND ENGINES

Send for a copy of our Quarterly Publication "The Launch." Catalog for the postage 10c.

TRUSCOTT BOAT MFG. CO.
St. Joseph, Mich., U. S. A.



Selected for exclusive use at the

World's Fair

on a decision based solely upon merits

WARM BLACK TONES ON VELOX.

The color of the silver precipitate with the various developers is the same whether one uses sodium sulphite or potassium metabisulphite as preservatives, but the employment of acetone sulphite in large quantities influences it. This is principally due to the fact that an addition of soda, potash, caustics, tribasic sodium phosphate or other alkali liberates acetone from acetone sulphite. Such developers are specially suited for Velox and Rotox, and produce varied tones, black to sepia. The following developer gives a soft, warm black with Velox, while the ordinary metolquinone formula, otherwise good, gives a cold black:

Edinol	1	grain
Hydroquinone	1	grain
Acetone sulphite	3	grains
Tribasic sodium phosphate (pure)	16	grains
Water	2 1/2	drams
Ten per cent. bromide solution	10	drops
—Photog.		

PALMER

Stationary and Automobile Motors



YANKEE POWER Fishing Boat, \$150. SPECIAL 17-foot Launch, \$185. Gasoline motors for working and pleasure boats, 1 1/2 to 25 h. p. Launches in stock. Send for Catalog. PALMER BROS., Cos Cob, Conn.

Fay & Bowen Motors & Launches

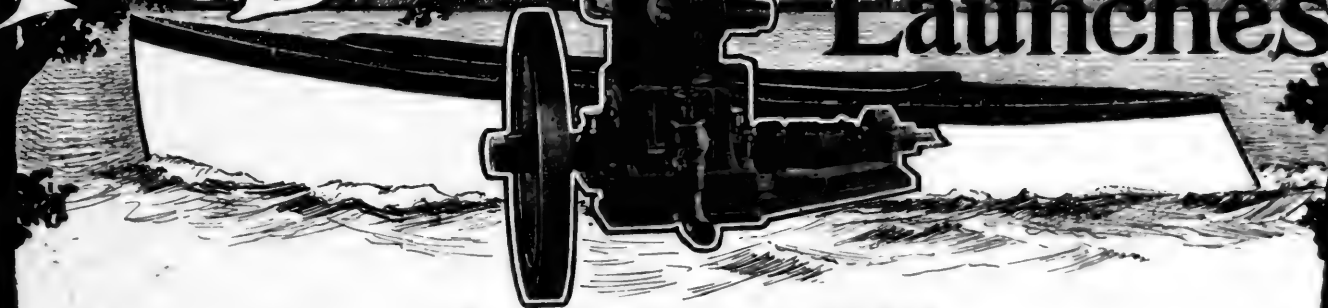

OPERATED BY GASOLINE VAPOR

The Fay & Bowen Marine Motor is a revelation to those who have used others. Reliable, safe, durable and easy to operate. Remarkable speed control. Best of all, it starts when you start it. No handle or crank is used. Our patent igniter is absolutely unique and always instant and positive in action. It is really the only perfect and satisfactory igniter.

Motors complete from $1\frac{1}{2}$ to 25 actual Horse Power ready for installation.

We also build a line of the finest launches afloat, complete and with our motor installed and all ready to run. We make these in either the usual round stern model or our flat stern torpedo model in lengths from 18 to 35 feet. We can furnish large cabin launches on special order. For excellence of workmanship and beauty of finish and design our boats are unsurpassed. Ask for description of our fast torpedo outfits.

Send for Catalogue and live testimonials from satisfied customers. Our customers are our best advertisers.

FAY & BOWEN ENGINE CO. ²⁸ Mill Street, Auburn, N. Y.

The $3\frac{1}{4} \times 4\frac{1}{4}$ pocket Poco, given by RECREATION as a premium for 6 new subscribers, arrived all safe. I wish to thank you very much for your promptness in sending it, and I am well pleased with the camera. I have no doubt it will prove as good as it looks. I had no difficulty in securing the required number of subscribers, and hope to be able to secure more.

Harry Messenger, Danville, Que.

Mrs. Buggins—I don't feel at all comfortable in these new shoes.

Mr. Buggins—What's the matter; don't they hurt?—Philadelphia Record.

18 Ft. Long
4½ Ft. Wide

Non-Sinkable Steel Automobile Launch \$250

Fitted with powerful Automobile, four cycle marine engine, cannot sink, cannot rust. Capacity ten to twelve people.

Non-Sinkable Steel Launches, Row Boats, Sail Boats, Canoes, Duck Boats, etc.

Made from the best quality Apollo Steel—will last a lifetime. Send for catalogue. Write for agents' discount.

MICHIGAN STEEL BOAT CO., 1275 Jefferson Ave. DETROIT, MICH., U. S. A.

RUSHTON CANOES

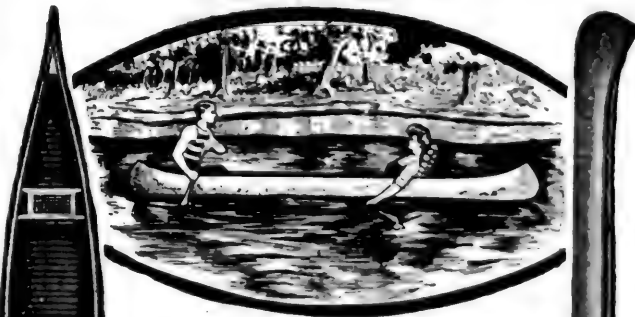

Buy a Canoe This Year

and then at the end of the summer's vacation you will have something to show for it. You'll get far more pleasure and benefit from paddling on lake or river than from expensive livery teams. Next year you will be already equipped for another season.

For quality of materials, strength of construction and beauty of design—for speed, lightness and durability, I can give you best value for your money. All styles and sizes, either all cedar or canvas-covered cedar.

Send for my Catalogue of pleasure boats, all-cedar and canvas-covered canoes, oars, paddles, sails and fittings—free for the asking.

J. H. RUSHTON, 817 Water St., Canton, N. Y.

THE LATEST, SAFEST AND BEST CANVAS BOAT

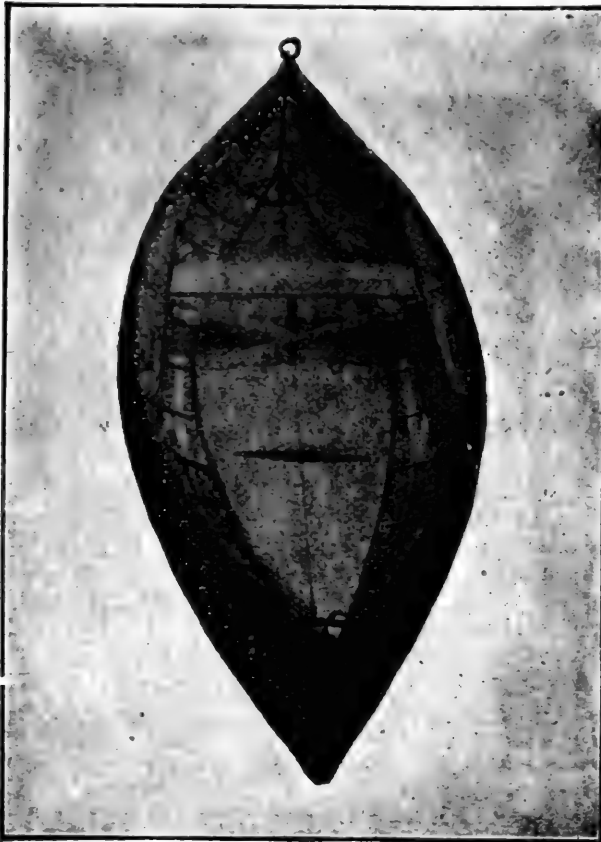

Is what we offer you. A Boat built on modern lines that will prove a pleasure to own and use. Selected materials used throughout, and it comes to you **guaranteed** the best. A handy and safe boat for fishing and shooting. Send 4 cents in stamps for catalogue and reliable testimony.

Mention RECREATION.

LIFE SAVING FOLDING CANVAS BOAT CO.
757 Portage St., Kalamazoo, Mich.



Latest patent and improved Canvas Folding Boat on the market. Puncture proof; Tempered steel frame. No bolts to remove. Folds most compact of any boat made.

Detachable Even Spoolers & Hook-Shields

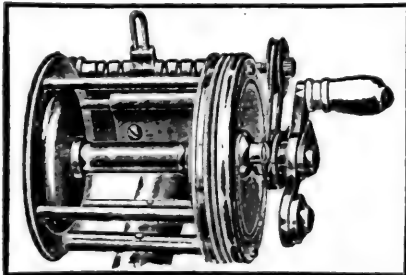

are the real thing. A boon to anglers. For proof ask any of the 7,000 users. In every case, as far as we know, they have given perfect satisfaction. In future buy only reels fitted with spooler or reels spooler will fit, preventing regrets later on. Our free catalogue (B) gives names of reels spooler will fit, price and description of Spoolers, Hook-Shields, Gun-Cleaners, Fish-Scalers, Ball-Bearing, Jeweled and Steel-Pivot-Bearing Reels fitted with even Spooler, also New Rubber Hook-Shield.

Bearing Reels fitted with even Spooler, also New Rubber Hook-Shield.

We exchange goods with Dealers any time to keep them in line with requirements in their locality.

A. W. BISHOP & SON, PATENTEES AND MANUFACTURERS
RACINE, WIS., U. S. A.



ACME FOLDING BOAT CO., MIAMISBURG, O.

Send for catalogue of our full line of Folding Canvas Boats and Canoes, which have been adopted by Governments of United States, Canada and England. Just filled an order for U. S. Government, who prefer our boats. Received medal and award at Chicago World's Fair. If you investigate we will get your order. Mention RECREATION.

Acme Folding Boat Company, Miamisburg, O.

A Sportsman's MULLINS "Get There" Steel Duck Boat



14 feet long, 36-inch beam.

Price \$20—Crated on cars Salem.

Endorsed by Thousands of Sportsmen. Air Chamber each end. Always ready. No repairs. Send for handsome free book. Mention Recreation.

W. H. MULLINS
228 Depot Street Salem, Ohio

RELIANCE

MARINE MOTORS **FOUR CYCLE**

LIGHT

POWERFUL

ECONOMICAL

1 to 6 Cylinders

4 to 150 horse power

Special Design for Auto Boats

Write for information and prices

RELIANCE MFG. CO.

City Island, N. Y. City

Gasoline and Steam
Engine Repairs

Mention RECREATION.

Watch this space
in May
RECREATION

For cut of a

New Fishing Tackle Box

Decidedly the most Novel
and Practical Box ever de-
signed. An enthusiastic

artist and sportsman says:

**"It is a revelation
and a revolution"**

For Advance Circular and
particulars address

Merriam Mfg. Co.

Durham, Conn.

Mention RECREATION.

BUILD YOUR OWN BOAT

BY THE **BROOKS SYSTEM**

\$5.00 EXACT SIZE PATTERNS. COMPLETE INSTRUCTIONS
EACH STEP ILLUSTRATED. HUNDREDS OF CUSTOMERS
FOR PATTERNS HAVE BUILT THIS COMBINATION ROW BOAT
OF THIS BOAT. SAIL BOAT AND LAUNCH IN FOUR DAYS TIME AT
A TOTAL COST OF \$14. MATERIAL PURCHASED
LOCALLY COSTS ABOUT \$8.60. PATTERNS OF
ALL KINDS AND SIZES OF BOATS AT PRICES
16 FT LONG-4 FT BEAM. FROM \$3 UP. PARTICULARS FREE
35¢ BRINGS 84 P. ILLUSTRATED CATALOGUE AND SET OF WORKING
INSTRUCTIONS AND ILLUSTRATIONS. WRITE TO DAY.
BROOKS BOAT MFG. CO., STA. B, BAY CITY, MICH.

Husband (of popular author)—Do you
mean to tell me, Doctor, that my wife is in-
sane?

"No, not so bad as that, but she is hope-
lessly foolish."

"Well, that's a relief. I was afraid her
usefulness as a writer was impaired."—Life.

Novelcraft Trimmed Bamboo Cane Poles



and other untrimmed rods
are made ready for reel
fishing in one-half minute.
Are reliable, practical, sen-
sible, economical and con-
venient. Complete set
trimmings, mail or dealer,

75 Cents, Dozen \$7.20
Patented, United States
and Canada, 1903.

The Novelcraft Mfg. Co.

Spring and Superior Streets, Cleveland, O.

CALIFORNIA



\$50

ROUND TRIP

Chicago to San Francisco and Los Angeles for strictly first-class tickets, with choice of routes going and returning, tickets on sale daily April 23 to May 1, with return limit June 30, 1904. Correspondingly low rates from all points. Admirable double daily train service includes the famous electric-lighted

THE
NORTH-WESTERN
LINE

OVERLAND LIMITED

Solid through train, less than three days to the coast, over the only double-track railway between Chicago and the Missouri River, and The California Express, with through service to San Francisco and Los Angeles.

The Best of Everything.

All Agents sell tickets reading via the

CHICAGO, UNION PACIFIC AND NORTH-WESTERN LINE

Send 4-cent stamp for booklet on California and pamphlet describing The Overland Limited and its route.

W. B. KNISKERN,

NW220 P. T. M., C. & N.-W. RY.
CHICAGO, ILL.



THE TOURIST ROUTE

TO
New Orleans, Texas, Mexico
and California.

THE NORFOLK & WESTERN RY.

OFFERS THE CHOICE OF THE

New York & New Orleans Short Line
OR THE

Famous Shenandoah Valley Route

Excursion tickets now on sale at greatly reduced rates, permitting stop-overs at Washington, Luray Caverns, Natural Bridge, Chattanooga, Lookout Mountain, Birmingham, New Orleans and other interesting points.

Address.

W. B. BEVILL, G. P. A. L. J. ELLIS, E. P. A.
Roanoke, Va. 398 Broadway, N. Y.

C. P. GAITHER, N. E. A.
112 Summer Street, Boston, Mass. 512

PATENTS

promptly obtained OR NO FEE. Trade-Marks, Caveats, Copyrights and Labels registered. **TWENTY YEARS' PRACTICE.** Highest references. Send model, sketch or photo. for free report on patentability. All business confidential. **HAND-BOOK FREE.** Explains everything. Tells How to Obtain and Sell Patents, What Inventions Will Pay, How to Get a Partner, explains best mechanical movements, and contains 300 other subjects of importance to inventors. Address,

H. B. WILLSON & CO. Patent Attorneys
786 F Street, N. W., WASHINGTON, D. C.

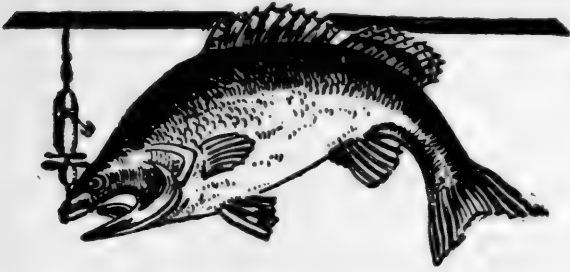

Fine Fishing Tackle Free

I want every enthusiastic fisherman, whether amateur, beginner or professional, to have a personal knowledge of the fine points of the Shakespeare Reels and the marvelous catching qualities of the Shakespeare Baits—and to do this I propose to send to every man or woman who fishes for the real sport there is in it, one of my reels and baits for free trial on their next fishing trip. Write to-day. Send your name and address and the name and address of the leading sporting goods dealer of your city to Wm. Shakespeare, Jr., 398 Shakespeare Bldg., Kalamazoo, Mich. The Shakespeare Reel is especially designed for accurate and long-distance casting, and it is without doubt the best reel in the world, and you will say so when you see it. The metal used in the Shakespeare Reel is hard-drawn brass and the finest English Stubb steel. Painstaking care is used to secure perfect accuracy in every detail. In beauty of design, and simplicity of construction it is unequalled. Its easy, silent running suggests perpetual motion and it is fitted with the most perfect drag and click ever invented. Words will not describe its beauty, its usefulness, nor its many advantages over all other reels. My reels and baits are for sale by all first-class dealers but I want you to see them and try them for yourself and I will send them to you direct, express prepaid, for a free trial. The Shakespeare Baits are really marvelous. With them the fisherman is sure of a good catch, no matter where the fish are, in the lake or stream. If they are in deep water, Shakespeare makes the bait that attracts them. If they are in shallow water, Shakespeare makes the bait that catches them. If they are hidden in the lily pads or moss, Shakespeare makes the bait that makes them strike. And Shakespeare offers \$100 in prizes for the photograph and authentic dimensions of the biggest large or small mouth bass caught this year. Write to-day for particulars. His little booklets, "How to Catch Bass" and "The Art of Bait Casting," are free to every angler. Write to-day.

SPORTSMAN'S FAVORITE



Get it from the Factory

This will save you one-third — the middleman's profit. A Sportsman's Cabinet is a right place for the guns, the ammunition, the boots, the fishing rods and tackle — everything. We make cabinets from **\$17.50 to \$48.**

Detach here and mail to-day

*West End Furniture Co.,
Williamsport, Pa.:*
Enclosed find 2c stamp for which send me your complete catalogue of Sportsmen's Cabinets. Write plainly. Mention RECREATION.

Name _____

Street _____

City _____ State _____

SPORTSMAN

Be your own Taxidermist

LEARN TO MOUNT ALL KINDS OF BIRDS, ANIMALS, HEADS, ETC.



We teach Taxidermy perfectly by mail. Easily and quickly learned. STANDARD METHODS, Expert instructors, reasonable price. Our SCHOOL FOR SPORTSMEN, BY SPORTSMEN, is endorsed by all leading taxidermists and sporting magazines. The spring shooting season is at hand. You will secure some beautiful specimens. They deserve a place in your home, den, or office. Are you interested? Our new illustrated catalog is just ready and IT'S FREE TO EVERY READER OF RECREATION. WRITE FOR ONE TODAY.

The Northwestern School of Taxidermy, Inc.
411 A BEE BUILDING OMAHA, NEB.

Taxidermists' Glass Eyes for Stuffed Birds, and Animals and Materials

Oologists' and Entomologists' Supplies

Send 5c. in stamps for catalogue

FRED. KAEMPFER, 88 STATE ST., Chicago, Ill.

Taxidermy work done in all its branches
Mention RECREATION



INDIAN CURIOS

WHOLESALE & RETAIL CURIO DEALERS' SUPPLY DEPOT.

Bead Work, Baskets, Elk Teeth, Mexican Goods, Beads, Fossils, Minerals, Arrow-Heads, Pottery, Alaska Ivories, Shells, Agates, Photos, Great Stock, Big Cata. 5c., stamps. Mention RECREATION. If a dealer say so.

L. W. STILWELL,

DEADWOOD SO. DAKOTA



Squab Book Free



Squabs are raised in 1 month, bring big prices. Eager market. Astonishing profits. Easy for women and invalids. Use your spare time profitably. Small space and capital. Here is something worth looking into. Facts given in our FREE BOOK, "How to make money with Squabs." PLYMOUTH ROCK

SQUAB CO., 289 Atlantic Ave., Boston, Mass.

TRAPPERS Send 2 Spring MUSKRAT SKINS by mail or 50 cents for 10 different numbers 1903 HUNTER-TRADER-TRAPPER, regular price 10 cents a copy, \$1.00 a year; for 1 skin, or 25 cents, 5 numbers. Offer good until May 1. A. R. HARDING, Gallipolis, Ohio.

FOR SALE

LIVE jack rabbits, prairie dogs, squirrels, deer, mandarin, wood and other wild ducks, geese, swan, and other game birds and animals.

CHAS. PAYNE, Wichita, Kansas.

FINE MOUNTED GAME HEADS, BIRDS, ETC., for sale at unheard-of prices.

Send 10 cents for photos.

JOHN CLAYTON, Taxidermist, Lincoln, Maine.

IN ANSWERING ADS. PLEASE MENTION RECREATION.

CLOSING OUT

The Best Collection in existence of the Mammals and Birds of Minnesota

CONSISTING OF



MOUNTED MAMMALS, HEADS, ANTLERS, SKINS, RUGS, MOUNTED BIRDS, SKINS, EGGS, FRESH SKINS, RELICS, CURIOSITIES, ETC.

Send Stamp

ERNEST L. BROWN

The Minnesota Taxidermist. Warren, Minn.

BIG INDIAN

TROUT AND GAME PRESERVE

Big Indian Ulster Co., New York

Brook Trout Fry, Yearlings and all sizes of large trout for stocking purposes and the table on hand.

All inquiries cheerfully answered.
Mention RECREATION.

Burnt Work — Something Great. To persons sending new subscriptions to RECREATION through me, or sending them direct to the office to my credit, I will send the following prizes:

For 1 new yearly subscription to RECREATION I will give a neat barrel match safe mounted on an oval back, both burned and decorated, equal in value to 75 cents.

For 2 new yearly subscriptions to RECREATION I will give a 6-inch round picture frame burned and decorated with beautiful old fashioned poppies tinted with water colors. This would cost you \$1.25 at the least.

For 5 new yearly subscriptions to RECREATION I will give either a round stool 14 inches high with round upholstered top or a square stool same height with square upholstered top. These would probably cost you \$7 or \$8 finished as I finish them with designs burned in the wood and leather.

E. A. King, Pleasant Prairie, Wis.

Duxbak

Sportsman's Coat

Sheds Water like a Duck's Back

An absolutely rain-proof coat. *Water will positively not soak through it or adhere to it.* Made of soft, smooth, pliable cloth that will not rustle or crack. Lined throughout with same material; reinforced by gun cap on shoulder and flap over shoulder seams. Patent bellows under arms permits free arm movements and affords perfect ventilation. Ample and roomy pockets for every purpose, protected by large flaps. Full cut—well tailored and trimmed. Material in light tan or dead grass colors. A perfect coat

For Fishermen

as well as the hunter. Rain-proof qualities, fit and satisfaction guaranteed or money refunded. Price \$5.00, express prepaid, to all points east of the Mississippi River. In ordering send snug breast measure close up under the arms, stating color desired. Samples on request.

BIRD, JONES & KENYON, No. 1 Blandina St., Utica, N.Y.



DEVELOPER TESTS.

A few simple tests by which to recognize the main constituent in a developer, or the developing agent in a solution, are as follows:

Pyrogallic Acid.—Nitric acid gives a deep red color. Ferric chloride gives a blue, becoming brown. Ferrous sulphate gives no reaction. Ferricyanide of potash gives deep red.

Hydroquinone.—Nitric acid gives dark red, changing to yellow if excess. Ferric chloride gives dark brown, gradually becoming paler. Ferrous sulphate gives light yellow. Ferricyanide of potash gives no reaction.

Metol.—Nitric acid gives deep red, gradually becoming light yellow. Ferric chloride gives deep red brown. Ferrous sulphate gives nothing. Ferricyanide of potash gives dark reddish yellow.

Eikonogen.—Nitric acid gives reddish color. Ferric chloride gives reddish brown. Ferrous sulphate gives violet red color if alkaline. Ferricyanide of potash gives nothing.

Glycin.—Nitric acid gives yellow red color. Ferric chloride gives reddish brown, becoming green and then violet. Ferrous sulphate gives nothing. Ferricyanide of potash gives light yellow.

Pyrocatechin.—Nitric acid gives reddish yellow color. Ferric chloride gives deep green. Ferrous sulphate, if floated where solutions meet, gives a crimson ring. Ferricyanide of potash gives nothing.—The Camera and Dark Room.

FOR Solid Comfort

SUMMER or WINTER

The
Best
is
the
Cheapest



Get a pair of
Thompson-
Quimby
Hunting
Boots

I Make the Best

All work guaranteed. I refer by permission to the Editor of RECREATION. Measurement blanks and prices on application. Mention RECREATION.

T. H. GUTHRIE

33 William St.

NEWARK, N. J.



THE 1902 Model

LEATHER-COVERED Pneumatic Recoil Pad is now perfect. No pump, no valve, no recoil, no flinch, no headache, no bruised shoulders, no money if not satisfactory and returned at once.

PRICE, \$1.50.

J. R. WINTERS
Clinton, Mo.

KOENIG'S SHELL EXTRACTOR.

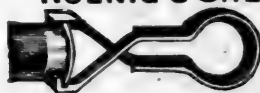

Every shooter should have one—carry it in a vest pocket. Fits any gauge shell. Koenig's Gun Catalogue, Free.

10 Cts. Postpaid.

E. G. KOENIG, NEW JERSEY'S LARGEST GUN HOUSE
SOUTH BROAD ST., NEWARK, N. J.

For Sale: L. C. Smith 12 gauge Shot Gun with 26 inch barrels, weight 6 lbs. 12 oz.; \$115.00 grade with automatic ejectors, hammerless, fine English walnut stock, engraving and checking. Has not been shot over a dozen times. Price \$50 cash. \$4 Leg of Mutton Case and Marble cleaning rod included. Address T. P. Peckham, care Savage Arms Co., Utica, N. Y. Mark all communications "Personal."

"Young Faddethwaite doesn't seem to have any moral courage," said her father. "I don't know anything about that," she answered, "but he wears stunning clothes and has 3 automobiles."—Chicago Herald.

Free: To any one sending me 5 new yearly subscriptions to RECREATION, I will give 1 pair Snowshoe Rabbits or will sell for \$4 a pair. Stanley L. Trees, Tie Siding, Wyoming.

For Exchange: 2 years RECREATION, 1902-1903; 3 years Sports Afield, 1901-1902-1903, for best offer. Frank R. Seaver, Darien, Walworth Co., Wis.

SOME GOOD GUIDES.

Following are names and addresses of guides who have been recommended to me, by men who have employed them; together with data as to the species of game and fish which these guides undertake to find for sportsmen.

If anyone who may employ one of these guides should find him incompetent or unsatisfactory, I will be grateful if he will report the fact to me:

FLORIDA.

C. H. Stokes, Mohawk, deer, alligators, turkey, quail, and snipe.

IDAHO.

John Ching, Kilgore, elk, bear, deer, antelope, mountain sheep, trout and grouse.
Chas. Petty's, Kilgore, ditto.

MAINE.

H. R. Horton, Flagstaff, deer, bear, moose, caribou, fox, grouse and trout.
Eugene Hale, Medway, ditto.

MONTANA.

A. R. Hague, Fridley, elk, deer, mountain sheep, bear, grouse and trout.
Chas. Marble, Chestnut, ditto.

WASHINGTON.

Munro Wyckoff, Port Townsend, deer, bear and grouse.

WYOMING.

S. N. Leek, Jackson, elk, bear, deer, mountain sheep, antelope, grouse and trout.

CANADA.

Carl Bersing, Newcastle, N. B., moose, caribou, deer, bear and grouse.

NEWFOUNDLAND.

John C. LeMoine, Birchy Cove, Bay of Islands, caribou, salmon and trout.

For Sale: 7½ lb. 12 gauge W. W. Greener, Forester grade, hammer gun; 30 in. choke barrels; 14 in. P. grip stock; 2¾ in. drop; in excellent condition; cost \$85.00; will take \$30.00 cash; no trades. John Spencer, Blacksburg, Va.

For Sale or Exchange: Guitar, Type-writer, Bicycle, Cameras, 2-22's, 30-30, 25-35 rifles; Baker Gun, Steer Horns. Enclose stamps. Josiah Winants, Little Falls, N. Y.

Date, _____ 190

G. O. SHIELDS,

Editor and Manager of RECREATION, 23 West 24th St. New York.
Herewith find \$1.00 for which please send me RECREATION one year beginning with _____ number,

Name, _____

Remit by P. O. or Express Money Order, or New York Draft.

DETACH THIS, FILL OUT, AND SEND IN

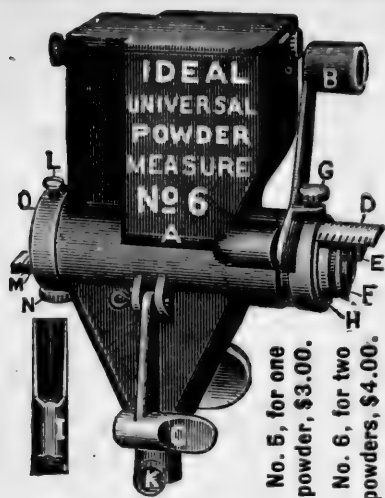

No. 5, for one powder, \$3.00.
No. 6, for two powders, \$4.00.

POWDER! POWDER!

All kinds of powder for **Rifles, Pistols** and **Shot Guns, measured accurately** from 1 to 145 grains. 4 different measures in 1. The latest and best tool. Ask your dealer for it.

Every shooter should have 1. Send 3 stamps for **Ideal Hand Book**, 146 pages of information to shooters.

IDEAL MFG. CO., 120 St., New Haven, Conn., U. S. A.

The PHIL B BEKEART CO., of San Francisco, Cal., Agents for Pacific Coast

When you write kindly mention RECREATION

CEDAROLEUM ^[TRADE MARK] The Ideal Lubricant and Rust-Preventive

Keep up with the times and in this New-Year try something "NEW" and "BEST OF ALL."

It is colorless and you can use it anywhere on your gun or rifle. Manufactured of the purest chemicals, it meets a demand and need. Far superior to any oil or vaseline. It is specific for cleaning rifles and guns after using nitro-powder as well as black. Will prevent RUST.

Its peculiar substance makes it the finest of LUBRICANTS for the mechanism. Put up in a neat tube with an injector, and is handy to carry in your pocket. **Postpaid sample, 15 cents.**

CEDAROLEUM CO.

Mention RECREATION.

PERKINSVILLE, VT.

BRADLEY'S ANTI-RUST ROPES!

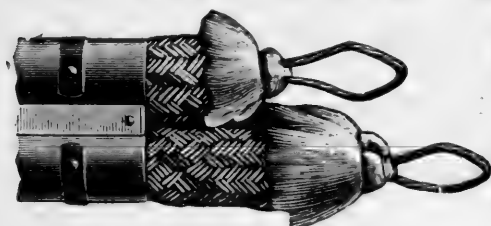

For SHOT GUNS, RIFLES and REVOLVERS. They cannot rust or pit if these ropes are used. No more worrying to keep your fire arms in perfect condition. Sent postpaid, \$1 per set for Shot Guns; 50c. for Rifles; 25c. for Revolvers. Give gauge and length of barrel. Send for circular giving full particulars.

BRADLEY'S SHOT GUN SIGHT

Makes wing shooting easy and certain. Scores greatly increased at trap and in field. Instantly attachable and detachable. Price, post-paid, 50 cents. Send for circular.

Address C. L. BRADLEY, CLARKSVILLE, TENNESSEE.
Mention RECREATION.

A coon spelt his name with a "Mc."
Said a friend, "You're not Irish—you're
Blc!

"No one knows," he replied,

"For in daylight I hide—

I goes out after dark in a Hc!"—Life.

It is easily seen that wherever RECREATION is taken the friends of game protection increase amazingly.

J. J. Mather, Springboro, Pa.

There was a young fellow named Rill,
Who was taken exceedingly ill,
But he said, "I'm an ass if I
Think I can pacify
This pain in my lungs with a pill.

For Sale or Exchange: A Boat to sell or exchange for a .30-.30, 32-40, .303 or 32 Special Rifle. W. G. Pollock, Little Falls, N. Y.

No Rifle complete unless mounted with one of our

IMPROVED TELESCOPIC OUTFITS

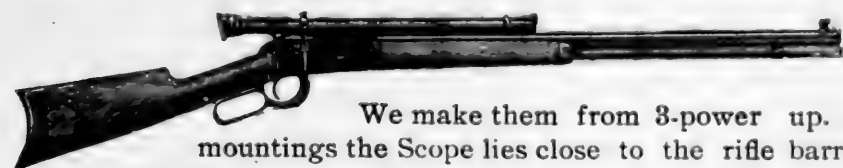

We make them from 3-power up. With our side mountings the Scope lies close to the rifle barrel and the open sights are left entirely clear and unobscured.

SEND FOR OUR CATALOGUE

Mention RECREATION.

THE MALCOLM RIFLE TELESCOPE MFG. CO.

F. T. CORNISH, Mgr.

Established 1857

SYRACUSE, N. Y., U. S. A.

SLEEP

IS TIRED NATURE'S
SWEET RESTORER

After a hard day's tramp, you must have

A Good Night's Rest

in order to fit you for the next day's work. Better to sleep on a good bed without your dinner, than sip at a banquet and then sleep on the cold, hard, wet ground. You can get

A Recreation Camp Mattress

of rubber, with valve for inflating, made by the Pneumatic Mattress Co., and listed at \$18.

For 10 Yearly Subscriptions to
RECREATION

Send for Sample Copies

Address RECREATION, 23 West 24th Street, New York.

Swedish
COLLAN
OIL

Waterproof
LEATHER
DRESSING
AND
RUST
PREVENTER

"Collan-Oil"
preserves leather and
renders shoes and
harness positively
WATERPROOF
Used by the U. S
the Army and Navy
and National Guard.
Send 25c. for trial can.
AGENTS WANTED

Write for terms and circulars
J. R. BUCKELEW
Dept. A. 111 Chambers St., N. Y.

Practical Common Sense **CAMP**
in 6 Sizes. **STOVE**



Either with or with-
out oven. The light-
est, strongest, most
compact, practical
stove made. Cast
combination sheet
steel top, smooth out-
side, heavy lining in
fire box and around
oven, holds its shape, telescopic pipe carried inside the
stove. Burns large wood and keeps fire longer than any
other. Used by over 9,000 campers and only one stove
returned.
For catalogue giving full particulars, mention RECREA-
TION and address
D. W. GREE, Manufacturer, Griggsville, Ill.

THE BRADLEY SHOT GUN SIGHT!

Wing Shooting
is made easy and
certain by using
this gun sight.
Scores at trap
and in field
greatly increased by its use. Right and left birds are
bagged as easily as straight-away birds.
Price 50 Cents, Postpaid.
C. L. BRADLEY, Inventor, CLARKSVILLE TENN.

An office-seeker who wanted to repre-
sent the United States at Yokohama was
asked, "Do you speak Japanese?"

The applicant faltered; then said he did.
"Well, let me hear you speak it."

"All right! Ask me something in Japan-
ese."—Argonaut.

I can not too highly praise our old friend
and companion, RECREATION. It is a good
cure for all sorts of indigestion, a good tonic
and tissue builder. If you feel melancholy
read it, follow its advice; but do not take
too much fat off the land and become a
game hog.

Dr. C. A. Peterson, Hoboken, N. J.

I received the 14 foot King canvas boat
you sent me for subscriptions for RECREA-
TION. I have tried it and found it all and
more than the King Company represents.

H. A. Trotter, Buffalo, N. Y.

"To feather your nest you must have
money."

"Yes; nothing is so delightful as cash
down!"—Exchange.

**NEWHOUSE
STEEL TRAPS**

Made since 1848 by ONEIDA COMMUNITY

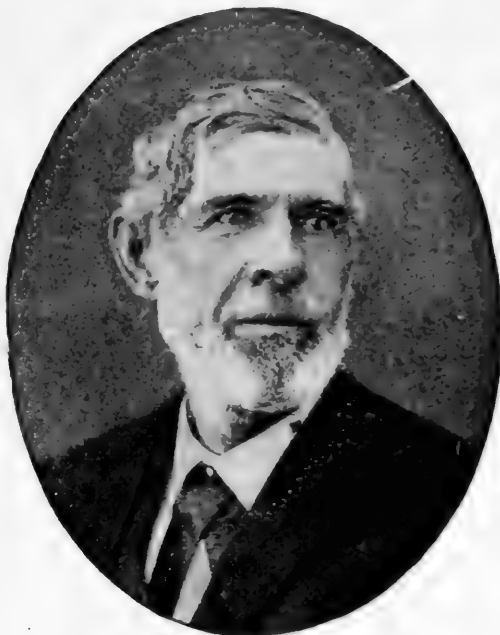

S. NEWHOUSE
(The Old Trapper and Trapmaker)

Fifty years ago this famous old Trapmaker of
the Oneida Community would not let a trap
leave his hand till he KNEW that it would hold
any animal that got into its jaws. Even greater
pains are taken now than then in selecting the
finest steel and rigidly testing every part.

This is why all experienced Trappers insist
on having the

"NEWHOUSE"

"I have seen an Indian trade his pony for one
dozen Newhouse Traps."—*Popular Magazine*
Writer.

**Eleven Sizes for Catching
Every Fur Bearing Animal****Every Trap Guaranteed**

Illustrated Catalogue Mailed

Send twenty-five cents for "The Trapper's Guide,"
by S. Newhouse, telling all about fur bearing animals
and how to trap them, together with interesting nar-
ratives and practical directions for life in the woods.

Mention RECREATION.

ONEIDA COMMUNITY
ONEIDA NEW YORK

H. & R. SINGLE SHOT GUN

Automatic and Non-Ejecting

The cheapest absolutely safe gun, with improvements found heretofore only in the highest priced.

PERFECT IN MODEL
AND CONSTRUCTION

SIMPLEST "TAKE
DOWN" GUN MADE

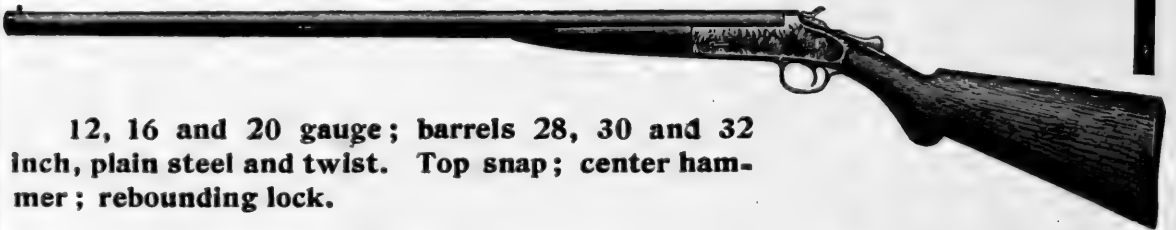

12, 16 and 20 gauge; barrels 28, 30 and 32 inch, plain steel and twist. Top snap; center hammer; rebounding lock.

Your dealer can supply, or we will sell to you direct. Write for Catalog.

HARRINGTON & RICHARDSON ARMS CO.

Dept. R, WORCESTER, MASS.

Makers of H. & R. Revolvers

GOOD READING CHEAP

16 vols. of RECREATION in fine condition, 1895, '97, '98, '99, '00, '01, '02, '03. Price \$5.00.

M. S. HUTCHINGS.

44 Mt. Vernon St., Dover, N. H.

Miss Roseate—Fred says he admires me because I am the picture of health.

Miss Pallid—Yes, the silly fellow was always crazy for anything hand-painted!—Life.

I received the Bristol steel rod you sent me as a premium. It is the finest rod I ever had in my hands. I have shown it to several friends and they are stuck on it.

J. A. Lewis, Fruitvale, Cal.

Prosecuting Attorney—Was the prisoner in the habit of singing when he was alone?

Pat McGuire (witness)—Shure, an' I can't say, for Oi was niver with him when he was alone.—Chicago Journal.

THE BAKER

THE GUN
THAT'S SAFE

SO DURABLE TOO
IT LASTS A
LIFETIME



If you want to be right up in the front rank of style and efficiency shoot one of our **Special Paragons** with *Whitworth* or *Krupp fluid steel* barrels. We have other patterns also that would please you. Our "Quarterly" tells about them and other matters that would interest you. We will send it you *free a year* if you want it. Mention RECREATION.

BAKER GUN & FORGING CO., 42 Liberty Street, Batavia, N. Y.

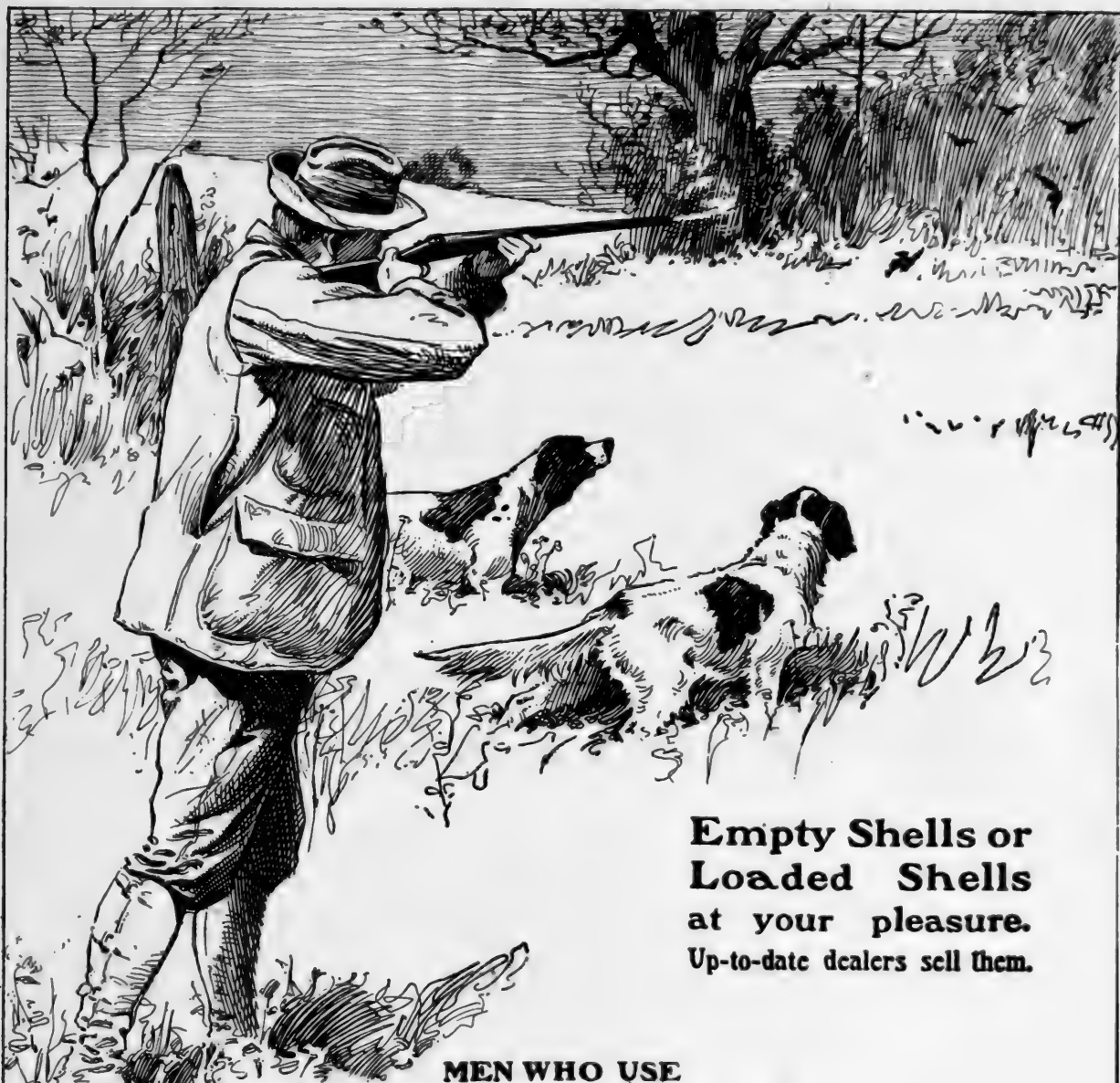

Empty Shells or
Loaded Shells
at your pleasure.
Up-to-date dealers sell them.

MEN WHO USE

**Robin Hood
Smokeless
Powder**

Make doubles right along. Clean, Quick, Hard-hitting.

Manufactured by

The Robin Hood Powder Co.
Swanton, Vt.

Send for Powder Facts.

Mention RECREATION.

HERE IS ANOTHER!

If you will send me

30 Yearly Subscriptions

to

RECREATION

I will send you

**A No. 10 Trieder = Binocular
Field Glass**

Listed at \$38.

Every well-informed man knows the great power of this modern prismatic field glass. It is indispensable to every hunter, and is one of the latest and best on the market.

I have but a few of these instruments on hand and the offer will be withdrawn as soon as the supply is exhausted. Therefore, if you want one

START IMMEDIATELY

Sample copies of RECREATION for use in canvassing furnished
on application

ITHACA

No. 1 SPECIAL \$21.

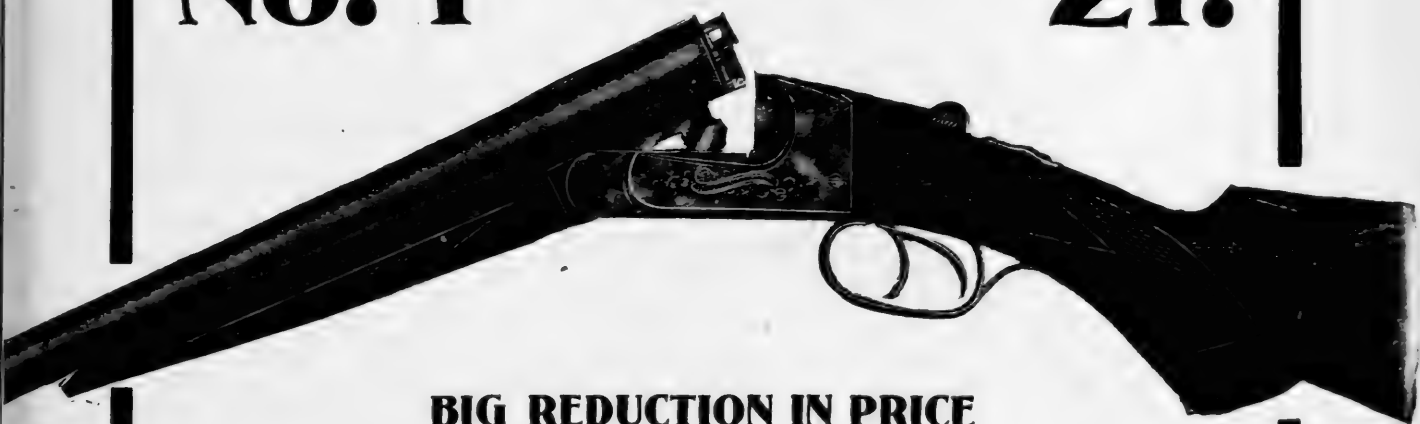

BIG REDUCTION IN PRICE

Retailed Last Year \$25.

WRITE FOR

Art Catalog

AND

SPECIAL PRICES ON 16 GRADES GUNS \$17.75 TO \$300.00

MENTION RECREATION

ITHACA GUN COMPANY

Ithaca, New York

DO YOU WANT A FOLDING CANVAS BOAT?

If So, Send Me

35 Yearly Subscriptions to RECREATION

AND I WILL SEND YOU

A 14 ft. King Folding Canvas Boat

LISTED AT \$48

capable of carrying 2 men and an ordinary camp outfit. There are thousands of these boats in use, and nearly every man who is using one of them praises it on every occasion.

Sample copies of RECREATION for use in canvassing will be furnished on application.

Address 23 West 24th St., New York

Syracuse Hammer Guns

Carry the same guarantee as our Hammerless Guns.

Built for Nitro Powder.

Bored the Syracuse way. Made of the best material.

Are, without doubt, the strongest built and hardest shooting Hammer guns made.

“Each gun targeted with Nitro Powder.”

**Roller Bearing
Tumbler**

**Double Wedge-Fast Bolt
Through Extension Rib**



List Price \$24.

12 gauge, 30 in. High quality steel barrels. Left barrel full, Right barrel modified choke. Weight 7¼ to 7½ lbs.

DESCRIPTION :

Top lever action. High quality hammered steel barrels. Particularly adapted to Nitro Powders.

Interchangeable locks. Roller bearing tumbler; this roller bears on mainspring, and gives an extremely easy and smooth cocking motion.

Low circular hammers.

Imported walnut stock, handsomely checkered grip and fore-end. Full pistol grip with ornamental caps.

Double scored butt plate.

One-piece lug with extra wide hinge bearing.

Double wedge-fast bolt through extension rib.

N. B.—But a limited number to be marketed this year. Write for further particulars. Mention RECREATION.

SYRACUSE ARMS CO.
SYRACUSE, N. Y.

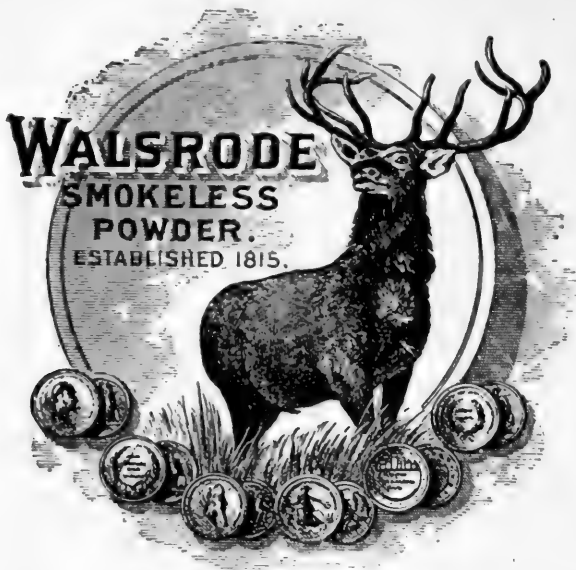

In Winter, there is
no powder
like

WALSRODE

Send \$2.50 for 100 12-gauge shells loaded with this powder. Mention size shot wanted.

Schoverling, Daly & Gales
302-304 Broadway, New York

AN IMPORTANT OFFER

For 2 Yearly Subscriptions to RECREATION
I will send you

A RIFLE WICK PLUG

Made by HEMM & WOODWARD, Sidney, Ohio, 30 caliber up to 50 caliber.

OR

A SHOT GUN WICK PLUG

20 gauge up to 10 gauge

For 3 Yearly Subscriptions to RECREATION
A Pair of Shot Gun Wick Plugs

20 to 10 gauge.

Sample copies for use in canvassing furnished on application.

Address RECREATION, 23 W. 24th St., N. Y. City

Look out for Flohr.

Readers of RECREATION are cautioned against doing business with Henry Flohr, who claims to be a representative of RECREATION. He is a swindler and should be arrested and locked up wherever found. He has taken a number of subscriptions to RECREATION and has failed to send in any of the money collected for same.

RECREATION is up to date, and better than some much more expensive journals of its class.
Dr. J. P. Horle, Cato, N. Y.



This is the New 9 F. Grade NEW LEFEVER

It is a plain gun, and sells at a popular price, but has all our latest improvements.

D. M. Lefever, Sons & Co.
Not connected with Lefever Arms Company,
Syracuse, N. Y.

Send for
1904
Catalogue
and
Discounts

Mention
RECREATION

A glance at a 22-caliber Savage Repeating Rifle will convince you that it is different from any other rifle you ever saw. Its beauty of outline and finish will always be a source of pleasure. Besides being the best gun for small game and target practice, it is the safest and simplest to handle and is sold to you under an honest guarantee. It will not jam or stick when you are in a hurry for a second shot, since *accuracy* and *reliability* are two of its particularly strong features.

Write to-day for catalogue G.

We have a special department entirely devoted to correspondence with sportsmen. It is always at your service. Write us, we can help you in the correct choice of a rifle and give some practical suggestions.

SAVAGE ARMS COMPANY

UTICA, NEW YORK, U. S. A.

Baker & Hamilton
Pacific Coast Agents
San Francisco and Sacramento, California

Papa—See here, Willie, you mustn't bother me. When I was a little boy, I didn't bother my papa with questions.

Willie—Maybe if you had, pa, you'd be able to answer mine.—Philadelphia Ledger.

“Mr. Smith had a hard time to get his daughters off his hands.”

“Yes, and now I hear he has to keep their husbands on their feet.”—Mail and Express.

Mrs. Smiler—Are you going to swear off drinking, New Year's, John?

Mr. Smiler—Why, certainly. Don't I every year?—Exchange.

I received the Harrington & Richardson revolver you sent me as a premium. It is the best and most accurate pistol I ever owned. The Mullins metal boat you gave me for 27 subscriptions is the safest, fastest and best boat that ever rode a wave. I shall be glad to answer any inquiries about my premiums or the way I got them.

Charles Sargent, Manchester, N. H.

Tommy—Say, ma, what made the baby holler so much last night?

Mrs. Cutting Hintz—I guess he heard me say he looked like his father.—Mail and Express.

THE PARKER
AUTOMATIC
EJECTOR

The Latest attachment to
The “**OLD**
RELIABLE”



New York Salesroom, Send for Catalogue. **PARKER BROS.,**
32 WARREN ST. Mention RECREATION. Meriden, Conn.

TO AMATEUR PHOTOGRAPHERS

Here is a Chance
to Get a
FINE CAMERA EASILY

A 4x5 Weno Hawk-eye film camera listing at \$8, for 5 yearly subscriptions to RECREATION. A No. 3 folding Weno Hawk-eye film camera, listed at \$15, for 10 yearly subscriptions to RECREATION.

These are both neat, compact, well-made and handsomely finished cameras, capable of doing high-class work.

*Sample copies for use in canvassing
furnished on request.*

Address RECREATION

23 West 24th St.

NEW YORK.

Get My Book, if Sick



Don't send a penny.
Wait until you see
what I can do.

Let me take all the risk.
Simply write.
I ask no more

I will send you my book.
I will arrange with
a druggist near-by so that
you may take six bottles.

Dr. Shoop's Restorative

A month on trial. I will absolutely stand all the cost if it fails. If you say "It did not help me," that ends it as far as cost to you is concerned.

Do You Understand Me?

I am telling it as plainly, as clearly as I can. I want you to know absolutely and without doubt that this offer is made on honor. I have the prescription that cures. My only problem is to convince you that Dr. Shoop's Restorative will cure—that it is an uncommon remedy.

A common remedy could not stand a test like this. It would bankrupt the physician making the offer. And I am succeeding everywhere and here is the secret of my success:

I found invariably that where there was a weakness, the inside nerves were weak. Where there was a lack of vitality the vital nerves lacked power. Where weak organs were found, I always found weak nerves.

Not the nerves commonly thought of, but the vital organs' nerves. The inside—the invisible nerves.

This was a revelation. Then my real success began. Then I combined ingredients that would strengthen, that would vitalize, these nerves. That prescription I called a restorative. It is known the world over now as Dr. Shoop's Restorative.

But do not misunderstand my offer. This is not philanthropy. Not free treatment, mind you, with nothing ever to pay. Such an offer would be misleading, would belittle the physician who made it. But I believe in a sick one's honesty, his gratitude. That when he is helped he will pay the cost of the treatment—\$5.50—and gladly.

And I make the offer so that those who might doubt may learn at my risk.

Thousands Have Written

Thousands are accepting this offer. And only one in each forty writes me that my remedy failed. Just think of it! 39 out of 40 get well—difficult cases, too. And the fortieth has nothing to pay.

That is a record I am proud of. It is wrong to stay sick when a chance like this is open. For I have made all the experiments that you can make. And the methods which failed me will fail with you. But the treatment that helped 600,000 others will just as surely help you.

So send for my book to-day. My way is probably your only way to get well. Every day that you wait will add a day to your suffering. Write a postal now to learn why.

If well, you should tell others who are sick, of my offer. Don't let a sick friend stay sick because he knows not of it. Tell him. Get my book for him. Do your duty.

You may be sick yourself sometime. Sick people need help. They appreciate sympathy and aid. Tell me of some sick friend. Let me cure him. Then he will show his gratitude to both of us. What greater reward can you have than that—a sick one's gratitude, his everlasting friendship.

Send for the book now. Do not delay.

Simply state which
book you want and ad-
dress Dr. Shoop.
Box 7214, Racine, Wis.

Book 1 on Dyspepsia
Book 2 on the Heart
Book 3 on the Kidneys
Book 4 for Women
Book 5 for Men (sealed)
Book 6 on Rheumatism

Mild cases, not chronic, are often cured with one or two bottles. At druggists.

These Colt Pistols are same as shown by the electrotype. only have not the Shell Ejector, being made for powder and ball.



Just received from Government Arsenal, Original cost, \$25.00

A Genuine "COLT" Pistol for \$2.75

100 Genuine Colt old style, Powder and Ball, Cavalry Revolvers, 7½-inch, round barrel, 44 Caliber, Brass Mounted, \$2.75
 Also 300 Remington ditto, same size, and in nice brown refinished condition, 2.50
 Also Leather Holsters for above Pistols,50
 Bullet Moulds (round and elongated ball)50

These Pistols are in nice second condition, almost as good as new. At the time of our Civil War were the most famous weapons of all. Are valuable, not only as relics of our Civil War, but as accurate shooting pistols for target or defense, and all right for use to-day. Orders accompanied by cash will be filled, and if goods are not satisfactory on receipt, they can be returned and money refunded, less cost of expressage.

JOB LOT OF 200

"American Make" Hammerless Double Guns



Closing out at \$18.50 to \$25.00 each

To any one wanting a thoroughly reliable, good shooting gun (not a cheap article got up to sell, but made by an *old established American maker*) these offer a chance that rarely occurs. They are top lever action, Greener style cross bolt, pistol grip, English Walnut stocks, best shooting powers, Sizes 28, 30 and 32 in., 12 bores, 6¾ to 7¼ lb. The guns at \$25.00 are makers' regular \$40.00 grades and have **auto-**

matic ejector. Send \$5.00 with order, and if gun is not satisfactory on receipt, it can be returned, and money refunded, less cost of expressage. If whole amount is sent with order, a nice Victoria canvas case is included. Our Specialty, **Fine Guns,** Scott's, Greener's Lang, and all makes. Send stamps for full Catalogues and list of second-hands. Some high cost bargains. We take second-hands in trade. Mention RECREATION.

WILLIAM READ & SONS, 107 Washington St., Boston

Montana Copper Mines: I have some very promising prospects in North-western Montana carrying gold, silver and copper values. Would sell outright, bond or give an interest to secure capital to develop property.

If you are interested, it would pay you to write me.

Sidney M. Logan, Kalispell, Montana.
Satisfactory references furnished.

Received the Shakespeare reel sent me and after having given it a thorough trial am more than pleased with it.

J. H. Primrose, Tecumseh, Mich.

Sir Charles bought a horse for a guinea,
And the brute was so dreadfully skuinea,

That a friend said, "Of course

It was meant for a horse,

But he hasn't got room for a whuinea!"

—Life.

"This is where the duke was assassinated."

"Indeed? But last year you showed us another room for that story."

"So we did, but that room is now being repaired."—Argonaut.

RECREATION is far ahead of any sportsmen's periodical I have yet seen.

E. L. Powers, Marlboro, Mass.

The Problem of Success

at the trap is largely a problem of equipment. It is generally conceded and once you have tried a

DAVENPORT

HAMMERLESS No. 2 GUN

with Full Length Matted Top Rib or our Heavy Hammer Trap Gun, you will agree that better results are obtained with a single than with a double gun. **The Single is positively the Trap Gun of the Future,** so get in line and procure the best for the purpose. Catalogue Free.

Mention RECREATION.

The W. H. DAVENPORT FIRE ARMS CO., Norwich, Conn.

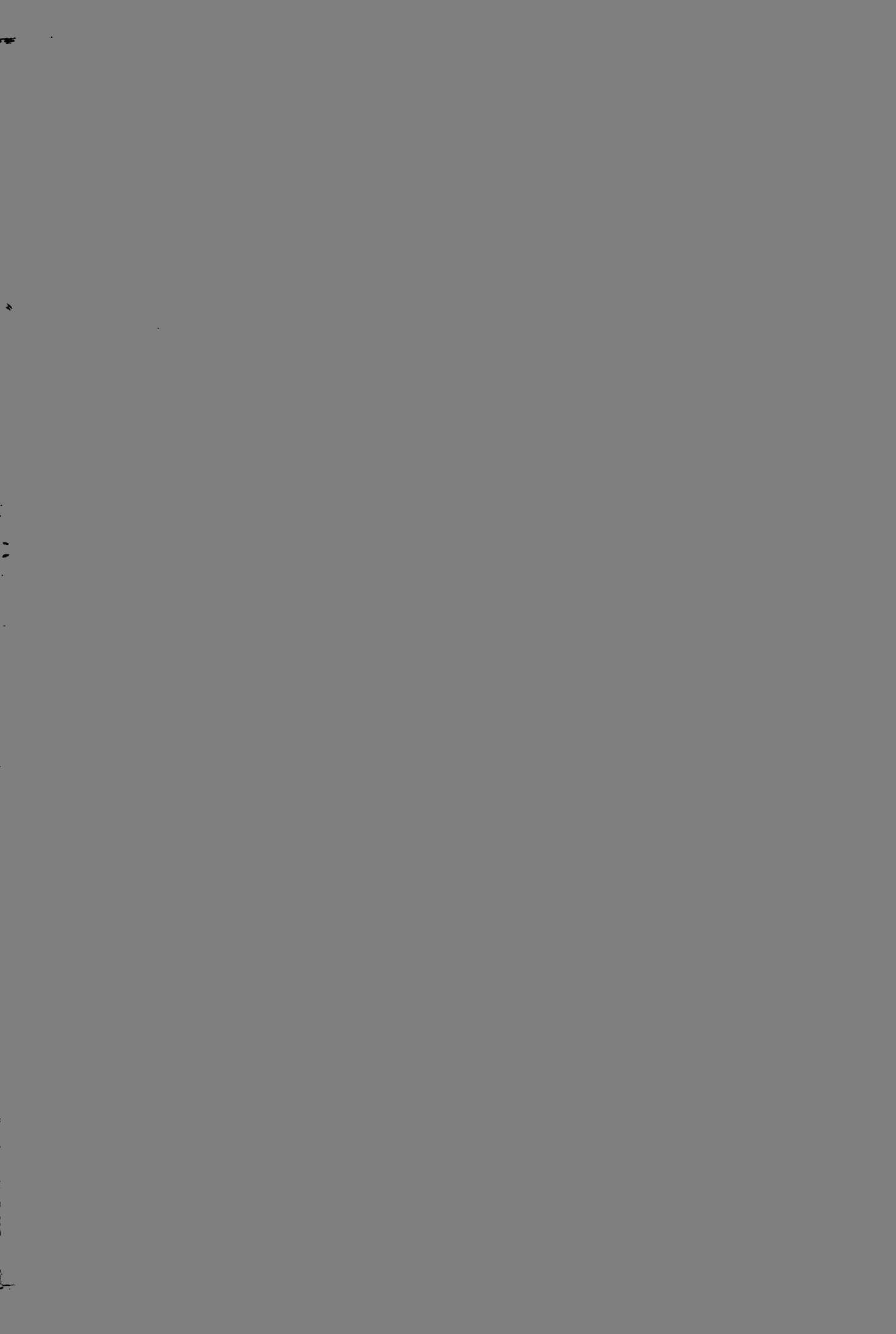

1874
1875
1876
1877
1878
1879
1880
1881
1882
1883
1884
1885
1886
1887
1888
1889
1890
1891
1892
1893
1894
1895
1896
1897
1898
1899
1900

By our
circ
inst
of expen
Boston, Ma

APR 27 1904

W. H. WELLS

DEPARTMENT OF THE INTERIOR
GEOLOGICAL SURVEY



U. S. GEOLOGICAL SURVEY, WASHINGTON, D. C.

Published by the Geological Survey, U. S. Department of the Interior, under authority of Act of March 3, 1879, section 269.

1. The first part of the document discusses the importance of maintaining accurate records of all transactions and activities. It emphasizes that this is crucial for ensuring transparency and accountability in the organization's operations.

2. The second part of the document outlines the various methods and tools used to collect and analyze data. It highlights the need for consistent and reliable data collection processes to support informed decision-making.

3. The third part of the document focuses on the role of technology in enhancing data management and analysis. It discusses how modern software solutions can streamline data collection, storage, and reporting, thereby improving efficiency and accuracy.

4. The fourth part of the document addresses the challenges associated with data management, such as data quality, security, and privacy. It provides strategies to mitigate these risks and ensure that data is used responsibly and ethically.

5. The fifth part of the document concludes by summarizing the key findings and recommendations. It stresses the importance of ongoing monitoring and evaluation to ensure that data management practices remain effective and aligned with the organization's goals.

The following table provides a detailed overview of the data collection methods used in the study. It includes information on the source of the data, the frequency of collection, and the specific variables measured. This information is essential for understanding the reliability and validity of the data used in the analysis.

Method	Source	Frequency	Variables
Surveys	Internal/External	Quarterly	Revenue, Expenses, Profit
Interviews	Key Personnel	Monthly	Operational Efficiency, Customer Satisfaction
Focus Groups	Customer Segments	Bi-annually	Market Trends, Consumer Behavior
Secondary Data	Industry Reports	Annual	Market Size, Growth Rates
Experimental Data	Controlled Environments	Continuous	Process Efficiency, Resource Utilization

The data collected through these methods is analyzed using a combination of qualitative and quantitative techniques. This approach allows for a comprehensive understanding of the complex relationships between different variables and the overall performance of the organization. The findings from this analysis are used to identify areas for improvement and to develop strategic initiatives that enhance the organization's competitive advantage.

RECREATION

Copyright, December, 1903, by G. O. Shields

A Monthly Magazine Devoted to Everything the Name Implies

\$1.00 A YEAR.

10 CENTS A COPY.

G. O. SHIELDS (COQUINA),

Editor and Manager.

23 WEST 24TH STREET,

NEW YORK

CONTENTS OF THIS NUMBER

	PAGE.
His Imaginary Buffalo Faced About and Raised Up, Fully 8 Feet High.....	FRONTISPIECE
A Race With a Grizzly.....	M. C. H. 331
Casting in Sluggish Waters.....	E. J. MYERS 333
How to Build a Log Canoe. Illustrated.....	G. O. SHIELDS 335
Rondeau. Poem.....	E. E. WEBSTER 337
How George Killed the Bear. Illustrated.....	W. S. BRITT 339
The Ozarks. Poem.....	L. C. ELERICK 340
A Visit to Banquet Mountains.....	JOHN W. BRYAN 341
The Capture of a Boss Trout.....	DON CAMERON 343
Song of the Angler. Poem.....	BENSON B. MOORE 344
Bushed.....	T. J. CUNNINGHAM 345
The Great Trout. Poem.....	HENRY CROCKER 349
The Hunter's Duel.....	STANLEY MAVALL 352
Alpine Animals in Colorado.....	W. H. NELSON 355
A Coconina Squaw.....	ALICE R. CRANE 357
Camping at Indian Lake.....	THOMAS A. BENNETT 358
A hunt in the Big Hole.....	CLARENCE JAY 359
How to Use a Pocket Compass.....	W. L. MARBLE 361
My First Day's Work. Poem.....	ARTHUR S. PHELPS 362
From the Game Fields.....	363
Fish and Fishing.....	369
Guns and Ammunition.....	373
Natural History.....	378
The League of American Sportsmen.....	382
Pure and Impure Foods.....	385
Publisher's Notes.....	387
Editor's Corner.....	388
Amateur Photography.....	392

Entered as Second-Class Matter at New York Post Office, Oct. 17, 1894.



**THE FASTENER
WITH A BULL-DOG GRIP.**

Washburne's Patent Improved **Fasteners**

Men find comfort and utility in their use. Applied to

Key Chain and Ring, 25c.	Scarf Holders, 10c.
Cuff Holders, 20c.	Drawers Supporters 20c.

Sent postpaid. **LITTLE, BUT NEVER LET GO.** Catalogue free.
Sold Everywhere.

AMERICAN RING COMPANY, Dept. 44

WATERBURY, CONN.

May Suggestions

THIS is the time of the year to look over the rods, polish up the guns, test the used lines, replenish the fly books and generally examine the various implements of the outdoor life. It is also a splendid time to plan outings for the coming season, to study guide books, maps and perhaps correspond with native experts on the spot. In all these things we can help you. Our establishment is a

Permanent Sportsmen's Show

Here you will find everything that the sportsman needs, from the big canoe to the tiny trout fly. We have guide books, maps, names of famous native and Indian guides, and, perhaps better than all, we have abundant personal acquaintance with the life in the woods and with scores of interesting places and trips. Our experience and information is at your service.

If you can not call at our shop send us your name, with 10 cents, and we will forward our Catalogue "R," which fairly smells of the forest and is full of the joys of the trail and camp fire.

Mention RECREATION.

ABERCROMBIE & FITCH

MANUFACTURERS OF COMPLETE

**Outfits for Explorers,
Campers and Prospectors**

314-316 BROADWAY, NEW YORK, U. S. A.

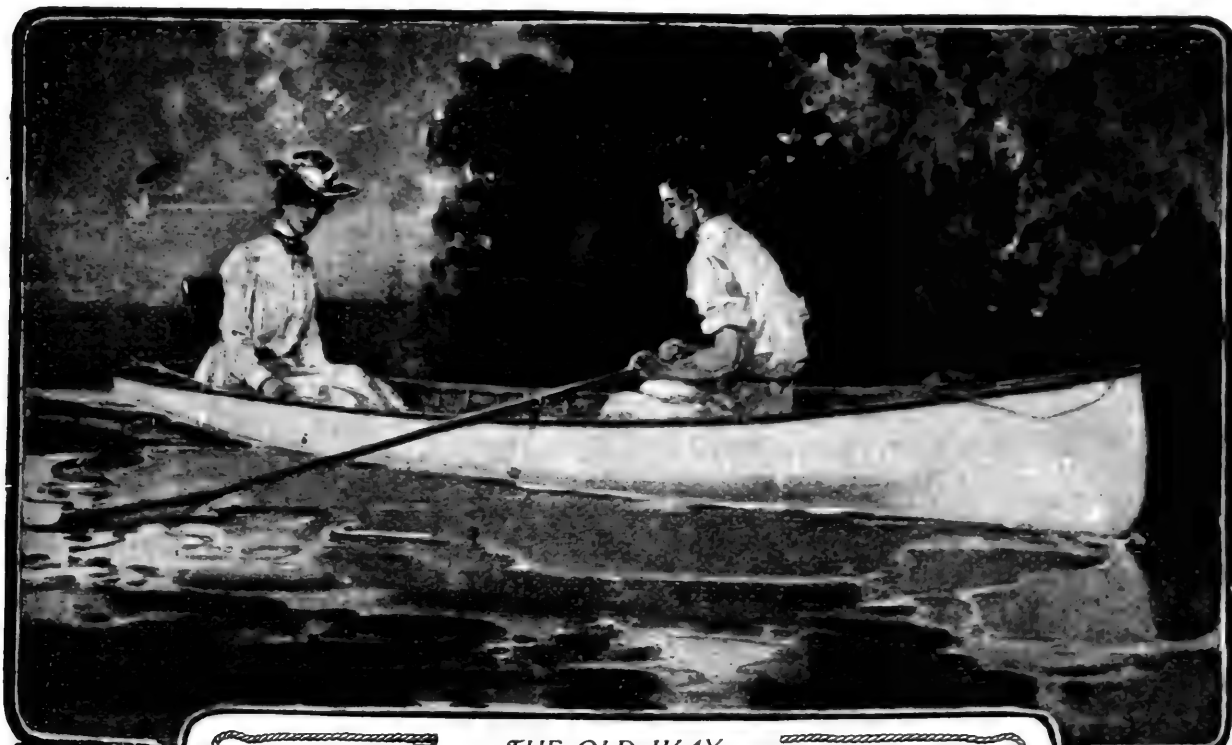

THE OLD WAY

THE BOAT as pictured below in every detail—length $15\frac{1}{2}$ feet, beam 4 feet, with $\frac{3}{4}$ h. p. Blomstrom gasoline engine,

\$100

*So simple a child can operate
with entire safety*

Catalogue D, including Marine Gasoline Engines of from $\frac{3}{4}$ to 80 horse-power at corresponding prices, free on request.

THE C. H. BLOMSTROM MOTOR CO.
1284-1294 River Street Detroit, Mich.

[From the Chicago Journal, May 7th, 1903]

At last an honest soul has put a $15\frac{1}{2}$ foot launch with gasoline engine—4 foot beam—within the reach of the masses.

THE NEW WAY

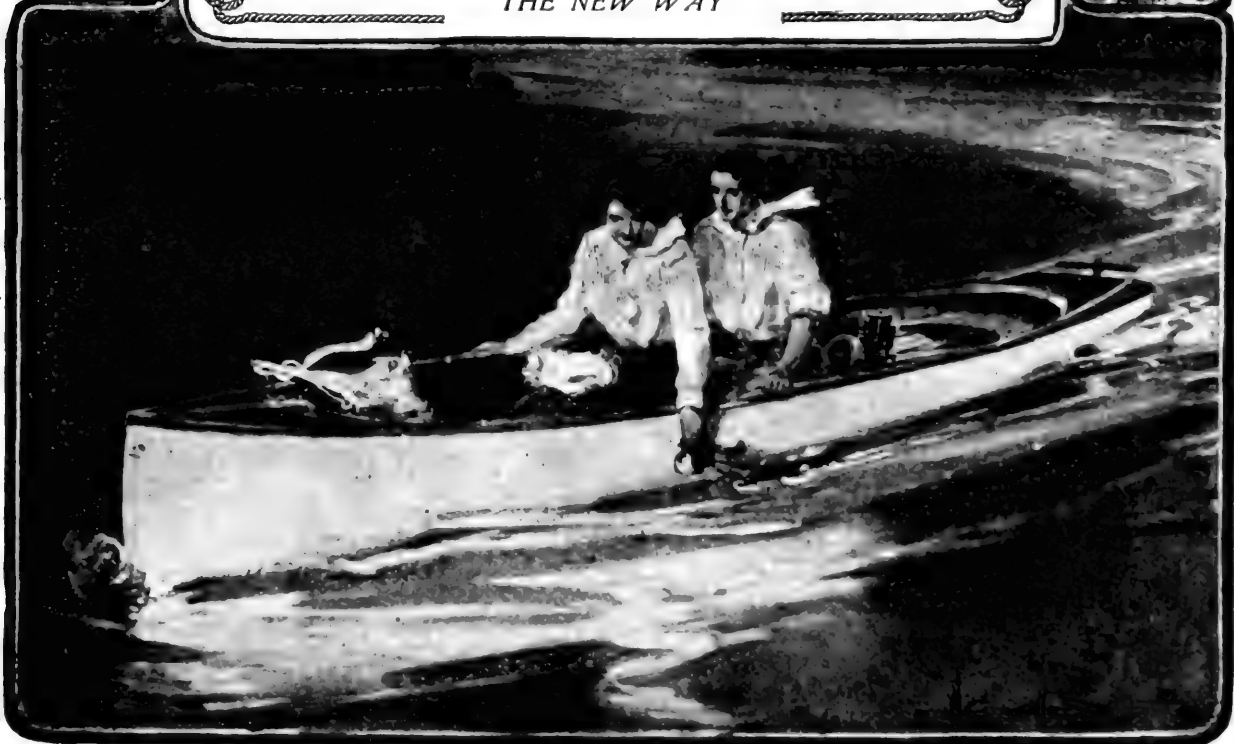

RACINE BOAT MANUFACTURING COMPANY

MUSKEGON, MICHIGAN

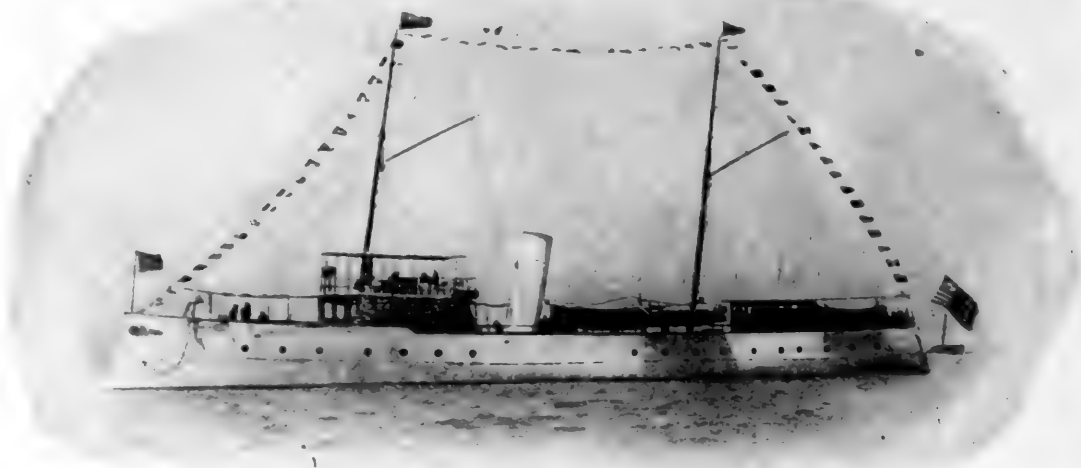

Yes, this is the same concern that builds the Hunting and Fishing Boats, Row Boats, Canoes, Motor Boats, Working Boats, Barges, Tugs, Engines and Boilers. We have been in this business for twenty-two years and are paying RECREATION \$200 for this advertisement to announce our removal from Racine, Wis., to Muskegon, Mich., just across the lake.

We build Steel and Wood Vessels, we also built the Yacht "Pathfinder," as shown above for Mr Morgan and she cost him \$75,000. We can duplicate her

for the same price. The Steel Steamer shown below we built for the U. S. Government Corps of Engineers. Yes, we built two for Uncle Sam's Engineering department at different times and he paid us \$5,000 each for them. They can also be duplicated for the same price.

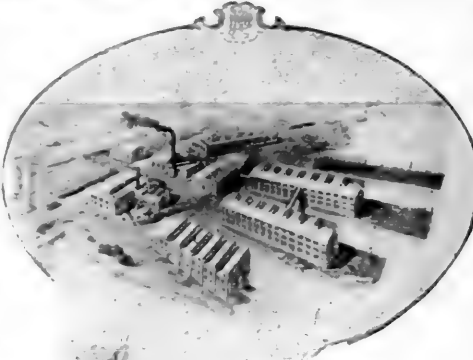

The little cut shows our plant at Muskegon, where all these boats are built and tested, and our 64 page catalog, which costs us 12c. each to print and mail, tells the truth in

detail about all our Boats. It is yours for the asking, or 10c. to cover mailing if you please.

Mention RECREATION.

Address: **RACINE BOAT MFG. CO., (Riverside) MUSKEGON, MICH.**



RACINE BOAT MANUFACTURING COMPANY

MUSKEGON, MICHIGAN



Our Turbine Motor Hunting Boat, as shown above, is 16 feet long, draws loaded only 10 inches of water, is fitted with our 3 H.P. motor and *underwater* exhaust. No springs, no valves, no *clicks*—as noiseless as a Row Boat. Speed 6 miles per hour. Operation and satisfaction guaranteed for \$275. Cheaper ones if you want them.



Our Canvas Cedar Paddling Canoe, as shown above, is 14 feet long, will carry four in a pinch and is built for service. A comfortable and easy paddler. Price, F. O. B., \$30—no extras.



Our Still Hunter, as shown, 11 1/2 feet long, 36 inches wide, built of White Cedar, will carry 600 lbs., weight only 80 lbs. Ample room under deck for decoys. Light weight, light draught, very stiff, very still and very cheap. Price, complete with paddle \$20, F.O.B.

Our 15 foot Fishing Motor Boat is the "limit." Has 4 foot beam, draws 12 inches, speed 6 miles per hour, seats four to five, will carry 1,000 lbs. 1 H. P. motor, operation guaranteed. Built of Cedar, natural finish, brass trimmed, a good troller, a good guide to the fishing grounds and a sure returner. We have them in stock at our various warehouses—price \$165. Money refunded if not satisfied.

Send 10c. for our 64 page catalog describing the others, and we will tell you the address of our nearest showrooms. If you haven't the stamps handy drop a postal.

Mention RECREATION.

Address: **RACINE BOAT MFG. CO., (Riverside) MUSKEGON, MICH.**

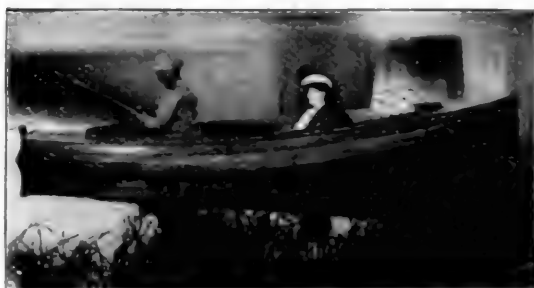

LAUNCHES

"Within the reach of all"



38 ft. cabin cruiser equipped with 10 H. P. naphtha engine. Furnished complete throughout, fitted with galley, lavatory, etc. Has sleeping accommodations for four people.

21 ft. open launch equipped with 2 H. P. naphtha engine. Over 5,000 of this type in use

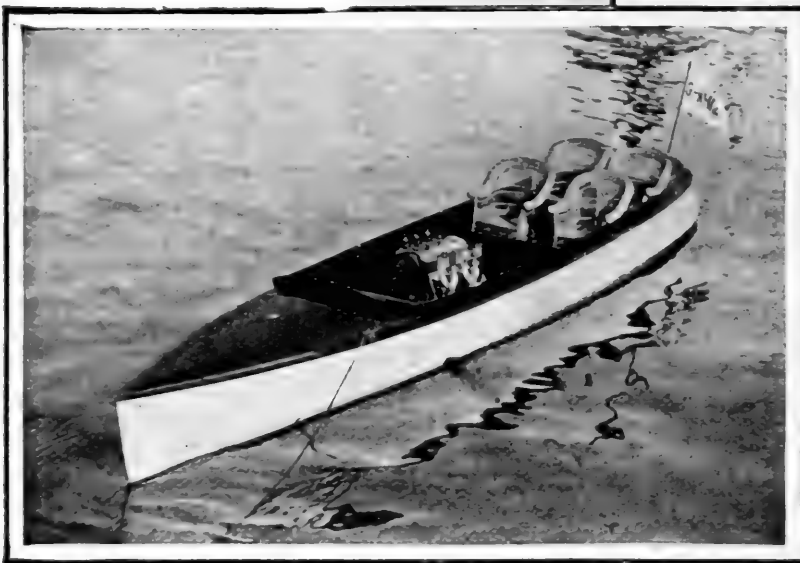

35 ft. auto-boat equipped with 12 H. P. new design Speedway Gasoline motor. We build these in sizes from 30 to 70 ft. Speed from 12 to 35 miles per hour.

Our show rooms contain 100 finished Launches to select from



Send 10 cents in stamps for new Catalogue of Auto-Boats, Naphtha or Alco Vapor Launches



Gas Engine & Power Co. and Charles L. Seabury & Co..

Consolidated

LARGEST BUILDERS OF PLEASURE CRAFT IN THE WORLD

Morris Heights, New York City

Down-Town Office, 11 Broadway

Chicago Office, 1409 Michigan Ave.



A
Summer Day
and a

CADILLAC

Model A Tonneau, - \$850

Without Tonneau, \$750

Model B Touring Car, \$900

Without Tonneau, \$800

For a delightful spin in the country; for business or pleasure; for quick and pleasant transit over long distances or short, there's nothing equals a *reliable* automobile.

No *reliable* automobile is so easy to buy, to operate, or to maintain, as a Cadillac.

No automobile at double the money is so strongly constructed, so speedy on good roads, so dependable on bad, so capable in the matter of hill-climbing, as the Cadillac.

Model A Tonneau (shown above) will carry four people safely, smoothly and comfortably at 30 miles per hour on the level stretches, and will go up a 45% grade.

Model B Touring car is identical in accomplishment, but has larger wheels, longer wheel-base, more roomy body. Both models are equipped with Goodrich 3-inch detachable tires.

Full appreciation of Cadillac superiority in design, construction and performance is possible only by personal inspection and trial.

CADILLAC AUTOMOBILE CO., Detroit, Mich.

Member Association of Licensed Automobile Manufacturers.

We'll be glad to send you Booklet K for the asking. It explains and illustrates all Cadillac models in detail, and gives address of Agency nearest you where they may be seen and tried.



TROUT STREAM



“Fishing on the Picturesque Erie,”

A Beautifully Illustrated Booklet containing valuable articles on fresh water fishes and fishing, written by veteran anglers, and a complete and reliable directory to the lakes and streams along

the lines of the Erie, where the best sport may be found. New and enlarged edition for 1904 will be ready for distribution about April 15th, and can be obtained from any Erie ticket agent in New York City and Brooklyn, or by sending four cents in stamps to the undersigned.

The Black Bass Fishing in the Upper Delaware is unsurpassed. The Erie follows the course of this beautiful river for over sixty miles.

Trout Streams too numerous to mention, but the Erie Fishing Book will tell all about them.

“Rural Summer Homes.” An illustrated directory to the Hotels and Boarding Houses in the beautiful Summer Land along the Erie, will be ready about April 1st. Free, on application to Erie ticket agents, or by sending eight cents in stamps, for postage, to



DELAWARE RIVER VIEW

D. W. Cooke, Gen. Pass'r Agent, New York

Mention RECREATION



**POPE
MANUFACTURING
COMPANY**

BICYCLE INNOVATIONS

TWO-SPEED GEAR *and* NEW COASTER BRAKE

Greatest Improvements since the coming of the Chainless

POPE QUALITY IN EVERY WHEEL

EASTERN DEPT., HARTFORD, CONN.

"Columbia"
"Tribune"

"Cleveland"
"Crawford"

WESTERN DEPT., CHICAGO, ILL.

"Rambler"
"Crescent"

"Monarch"
"Imperial"

Catalogues free at our 10,000 dealers' stores, or any one Catalogue mailed on receipt of a two-cent stamp



POCONO MOUNTAINS

**Lackawanna
Railroad**

For an ideal outing this Summer. The region is high, the climate invigorating and the trip comfortably made in three and one-half hours from New York. A handsomely illustrated book of 128 pages, containing complete information about hotels and boarding-houses, together with a delightful love story entitled "A Chance Courtship," will be mailed on receipt of 10 cents in stamps.

Address T. W. LEE, General Passenger Agent, New York City.

Angling Days

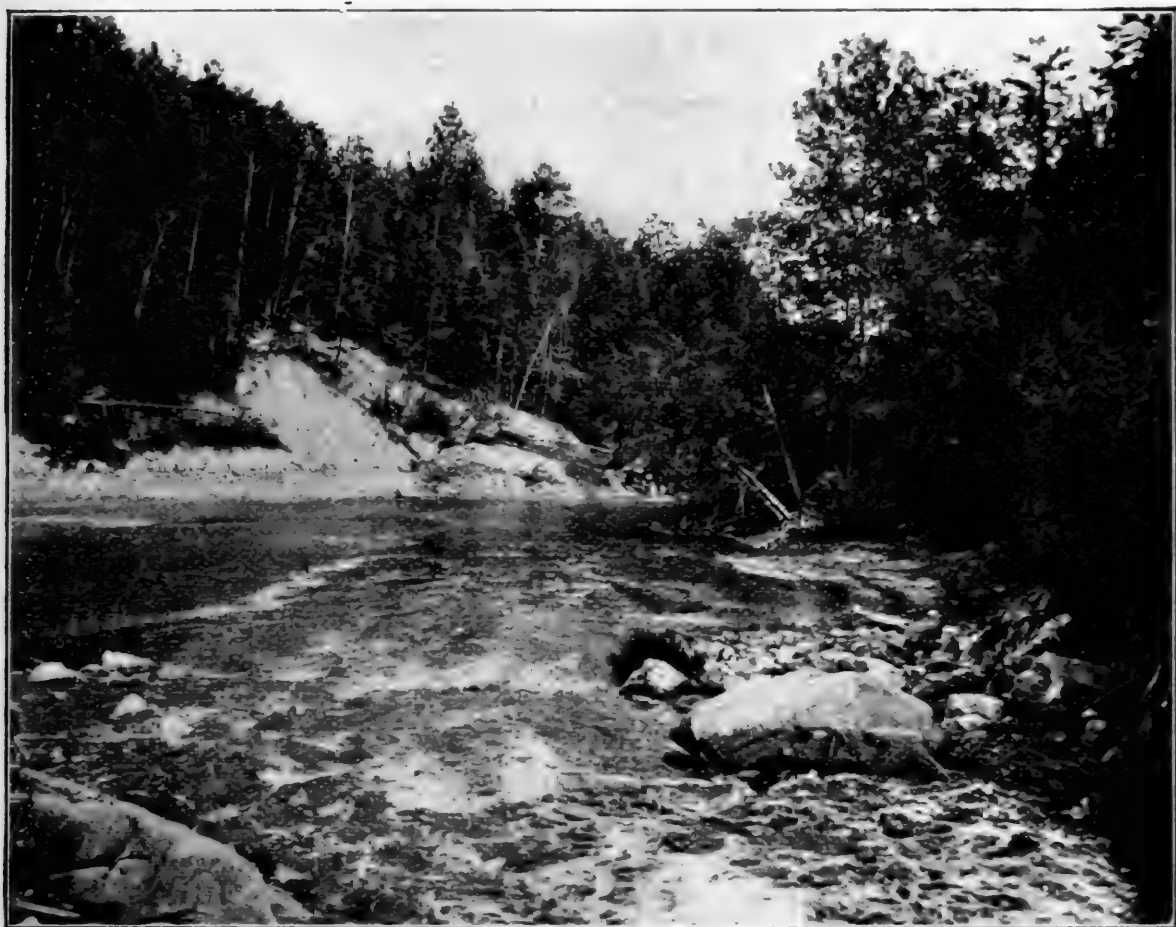

On the Gatineau

Once again the Angler is going forth with "rod and reel and traces" and a good many are heading toward the Blue Laurentians. By the way, have you tried that fisherman's paradise? If you have not, you should not fail to do so this year.

*Full information will be furnished by
any agent of the*

Canadian Pacific Ry

Robert Kerr, Passenger Traffic Manager, Montreal, Can.

Vacation Questions Answered

When planning your summer vacation, questions will arise which you can not answer readily.

We can tell you what you want to know about Colorado, Utah or California, the wonderful Yellowstone Park, the picturesque Black Hills of South Dakota, or the marvelous Puget Sound country.

It will be our pleasure, if you give us the opportunity, to tell you how to reach any of these points, how long it will take, what it will cost, what you can do and see when you get there, the cost of living, etc.

All these places are quickly and comfortably reached by the Burlington's thro' train and car service from Chicago and St. Louis. If you want to go somewhere for rest and recreation after visiting the World's Fair, write us.

Address the nearest representative of the Burlington Route, or use the following coupon, and the answer will reach you by return mail.



P. S. EUSTIS, Passenger Traffic Manager,
CHICAGO, ILL.

P

I want to go to _____
Please send me information about the place, the way to get there, the cost, etc.

Name _____

Address _____

P6



EEL RIVER FALLS



"WHERE THE TROUT HIDES", HIGHLANDS OF ONT.

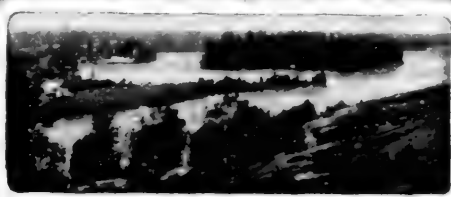

HEAD OF LAKE JOSEPH-MUSKOKA LAKES DISTRICT

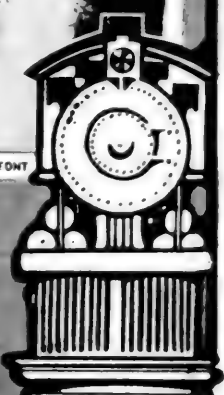
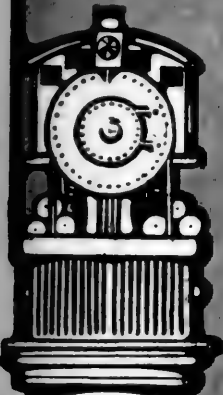

GRAND
TRUNK
RAILWAY
SYSTEM

GRAND
TRUNK
RAILWAY
SYSTEM

HIGHLANDS^{of} ONTARIO CANADA

AMERICA'S FAIREST
SUMMER RESORT DISTRICTS

INCLUDING

- | | |
|------------------------------------|---------------------------------|
| Muskoka Lakes | Lake Nipissing and French River |
| Lake of Bays | Lakes Simcoe and Couchiching |
| Maganetawan River | Kawartha Lakes |
| 30,000 Islands of the Georgian Bay | |

Wild, romantic scenery—pure, bracing air—fishing, boating, beautiful water trips—and

PERFECT IMMUNITY FROM HAY FEVER

It's fun even to read about it—handsomely illustrated descriptive matter, maps and all information FREE. Apply to

G. T. BELL
General Passenger and Ticket Agent
Grand Trunk Railway System
Montreal, Canada



A Wing Piano

is a joy in any household. You can get a strictly high-grade piano by writing us direct and can save \$100 to \$200 on it. Sent on trial. We pay freight. Easy monthly payments. No money required in advance. In 36 years we have sold 33,000 pianos and refer to over 33,000 satisfied purchasers. Wing Pianos are guaranteed for 12 years. "Book of Information about Pianos" sent free on request. Mention RECREATION.

Wing & Son

350 to 356 W. 13th St.

New York



THOUSAND ISLAND HOUSE,

ALEXANDRIA BAY,
ST. LAWRENCE RIVER,
NEW YORK.



STAPLES & DEWITT, Prop's.

1000 Island House

In the midst of the "Thousand Islands," the so-called "Venice of America," and really the most charming and delightful Summer Resort on the Continent.

Send us two 2-cent stamps and we will send you a beautifully illustrated guide book.

Mention RECREATION.

STAPLES & DEWITT, *Proprietors.*

Alexandria Bay, N. Y.

SENATOR STEWART SAYS:

United States Senate, Washington, D. C.

I have found HAYNER WHISKEY exceptionally fine for table and medicinal purposes.



U. S. Senator from Nevada.

**THE ONLY WHISKEY WITH A NATIONAL REPUTATION FOR
HIGHEST QUALITY AND PERFECT PURITY.**

Uncle Sam, in the person of Ten Government Officials, is always in charge of every department of our distillery. During the entire process of distillation, after the whiskey is stored in barrels in our warehouses, during the seven years it remains there, from the very grain we buy to the whiskey you get, Uncle Sam is constantly on the watch. We dare not take a gallon of our own whiskey out of our own warehouse unless he says it's all right. And when he does say so, that whiskey goes direct to you, with all its original strength, richness and flavor, carrying a **UNITED STATES REGISTERED DISTILLER'S GUARANTEE** of **PURITY** and **AGE**, and saving the dealers' enormous profits. That's why **HAYNER WHISKEY** is so good and yet so cheap. That's why we have half a million satisfied customers. That's why you should try it. Your money back if you're not satisfied.

HAYNER WHISKEY

4 FULL QUARTS \$3.20
EXPRESS CHARGES PAID BY US.

OUR OFFER We will send you **FOUR FULL QUART BOTTLES** of **HAYNER SEVEN-YEAR-OLD RYE** for **\$3.20**, and we will pay the express charges. Try it and if you don't find it all right and as good as you ever used or can buy from anybody else at any price, then send it back at our expense and your \$3.20 will be returned to you by next mail. Just think that offer over. How could it be fairer? If you are not perfectly satisfied you are not out a cent. We ship in a plain sealed case, no marks to show what's inside.

Orders for Ariz., Cal., Col., Idaho, Mont., Nev., N. Mex., Ore., Utah., Wash., or Wyo. must be on the basis of 4 QUARTS for \$4.00 by EXPRESS PREPAID or 20 Quarts for \$16.00 by FREIGHT PREPAID.

ESTABLISHED
1866.

THE HAYNER DISTILLING COMPANY,

DISTILLERY
TROY, OHIO.

DAYTON, OHIO.

ST. LOUIS, MO.,

ST. PAUL, MINN.,

ATLANTA, GA.,







HIS IMAGINARY BUFFALO FACED ABOUT AND RAISED UP, FULLY 8 FEET HIGH.

RECREATION.

Volume XX.

MAY, 1904

Number 5.

G. O. SHIELDS (COQUINA), Editor and Manager

A RACE WITH A GRIZZLY.

M. C. H.

The mention of Shot Gun valley in my old friend Rea's story in a former number of RECREATION, calls vividly to mind an exciting chase I had in that section 20 years ago, while on a hunting and trapping trip early in the spring. My brother Frank and I were riding leisurely up the valley, with pack animals and a few loose horses following, when directly ahead we saw a huge bear some half mile distant. To stalk him was out of the question as the ground intervening was as level as a barn floor, with the new grass but a few inches above the ground. This fact did not bother us, for, as is well known by men familiar with Bruin and his habits, he is seldom on the lookout, doubtless knowing he is not liable to be pounced on unaware by any of his neighbors who may be in quest of a square meal. His nose is all right; but as a light wind accompanied by a drizzling rain was in our favor, we hoped to ride within gun shot range before flushing him. Being armed with 44 caliber Ballard carbines, shooting distance meant not to exceed 150 yards. When still 400 yards distant the huge brute paused in his search for ground moles and, accidentally no doubt, glanced in our direction. Two mounts, 4 packs and a few loose horses meeting his gaze brought him at once in an upright position. One square look was sufficient. Dropping on all fours he broke for the nearest hills like a frightened horse.

Having been out of winter quarters long enough to work off his surplus

fat, he led us a lively chase. I had the better horse, soon distanced Frank and rapidly gained on the big fellow, who in the meantime turned more to the right and took the water of Shot Gun river like a duck. We crossed the stream, 40 yards wide and about 3 feet deep, with a rush and without my pulling rein. On reaching the farther bank we soon struck a higher bench, the rim of which was an ugly mass of large broken lava rock. That, too, was made without slowing down and then came the race in earnest across the wide, low bench, covered with scrub sage and buck brush. A mile farther and I was within 50 yards and commenced slinging lead. My war horse, Old Sport, had, the fall before, packed me alongside of more than one buffalo and was exerting all his strength to add another to the string; but after 2 or 3 shots, none of which counted, and when within 30 steps, his imaginary buffalo stopped suddenly, faced about and raised up fully 8 feet high. Old Sport spiked, plowing up the mud with his feet and nearly landing me over his head, as I had dropped the reins and at that moment had raised the gun to my shoulder. Before I could catch sight the race was on again and more powder and lead were wasted. Old Grizzly repeated his tactics, bringing us to several sudden halts; but would not face the music long enough to give me a steady shot.

As the chase had covered several miles, my horse began to show signs of weakening. His heaving sides were

covered with foam and were working like a bellows. Some change in the programme was necessary, so I dismounted at the next halt. Sport by that time was thoroughly frightened as well as nearly played. Not caring to part with him under the circumstances, I threw the reins over his head as I went out of the saddle, slipping my leg through them, dropped on one knee just as the bear settled

down for another spurt, and there was no more lead wasted. With his forepaw the bear marked the spot on his rear where the first shot stung him and continued to notify me where each succeeding bullet landed until, exhausted with his repeated efforts in that line, he quit for good, furnishing me with a beautiful silvertip robe, larger than any buffalo robe in our packs.



THE EAGLE'S GIBRALTAR.

AMATEUR PHOTO BY A. J. BRUNQUIST.

Winner of 27th Prize in RECREATION'S 8th Annual Photo Competition.

Willie—Mamma, can I go to bed half an hour earlier to-night?

Mrs. Lewison—What for?

"I want to say my prayers ahead for a week."

CASTING IN SLUGGISH WATERS

E. J. MYERS.

On many rivers the water empties into deep dark holes that deaden the current into a sluggish stream barely able to more than move the drift to the bar where the shallowing water pours over the shingle.

The Quat-a-wam-kedgwick is famous for its holes, the like of which do not exist even on the Grande Codroy. There the great salmon lie, but whether at the lower bar or in the middle of the pool you do not know, for you can not see 3 feet below the darkness that blackens up to the surface. If the salmon take your fly it is never with a rise, nor swell nor roll, but with a straightening of the line as if the fish was intent on going to the antipodes or running up the bank and climbing the mountain side. Many a time that is all you know, for never a sign is vouchsafed beyond motion.

Usually there is so much slack that the line seems as if it were uncoiling on the surface of the water, for the rod never bends but trembles and shivers in a shilly-shally way. The reel is dumb until it gives a frantic wail, and well it may, for that salmon never returns.

Then you will wonder why your guides did not back water or use some other one of a thousand expedients to get a taut line, but unless you have cast on the big holes and learned to handle slack, you will lose salmon, patience and guides. The latter, in that case, are likely to start back for the village; with you, if you are wise, and otherwise without you, as happened to an old friend of mine.

Now stop the canoe in the rapids so as to cast with a lengthening line where the heavy water stops, cast as long as you can to the uttermost length, for the partial stretch of heavy water will keep a line taut for some distance into the sluggish water.

Though you may not see it, you will appreciate as you raise the rod for the backward throw. Then move the canoe to the beginning of the heavy water into which the rapid seems lost in the dead stillness of the hole, and continue until you reach the middle of the hole, pulling your fly across it from current to current. Now cast, and as you cast wriggle the rod with the right hand which also holds the line which you draw through the fingers of the right hand with the left, so as to avoid any doubling and slack in the water, letting the line fall in the canoe as you reach for another draw.

Constantly wriggle and maintain the dip-dip of the rod which gives life to the fly while the drawing-in is done. The right hand will keep as taut a line as possible, and will serve to hold the line if the salmon should take the fly. Be sure to have a free place in the bottom of the canoe where the slack line falls, and that there is naught to entangle the line, because in the big holes you angle for great salmon, aye, 30 to 40 pounds and more, especially the Restigouche fish away up the main river.

Remember the danger of the slack between the hand and the reel, and if the salmon takes the fly hold the line with the right hand with a grim firmness that yields not a fraction of an inch as you deliberately raise the rod until it lowly bends and bows awaiting the salmon's rush, which must take out the line through fingers that slowly yield to a friction that burns to the bone. Never mind that, for you will save the salmon if you are so far advanced as to get burned.

Fail not to raise the rod slowly until it is well bowed but suffer not an inch of the line to pass through your fingers.

If you have been wise and thereto-

fore instructed your guides, though you stand or sit, you will find the canoe slowly moving away to the farthest distance of the pool, but always with the line projecting down into the water as if the salmon were running away from you. That is the secret of the battle, for that is holding the fly in the salmon's mouth and giving him the freedom of the river for his first rush, which will be up the river. Then and not till then, let the

line ooze through your fingers until the slack is gone and you hear the reel. Then all the chances against you have disappeared and all the hazards of the battle are evened.

I do especially believe in fighting the salmon from the shore when you are fishing in big holes. Have your guides assist you in getting ashore and place the canoe at the lower end of the hole, so as to be ready for you to follow the salmon if it start to rush down stream.

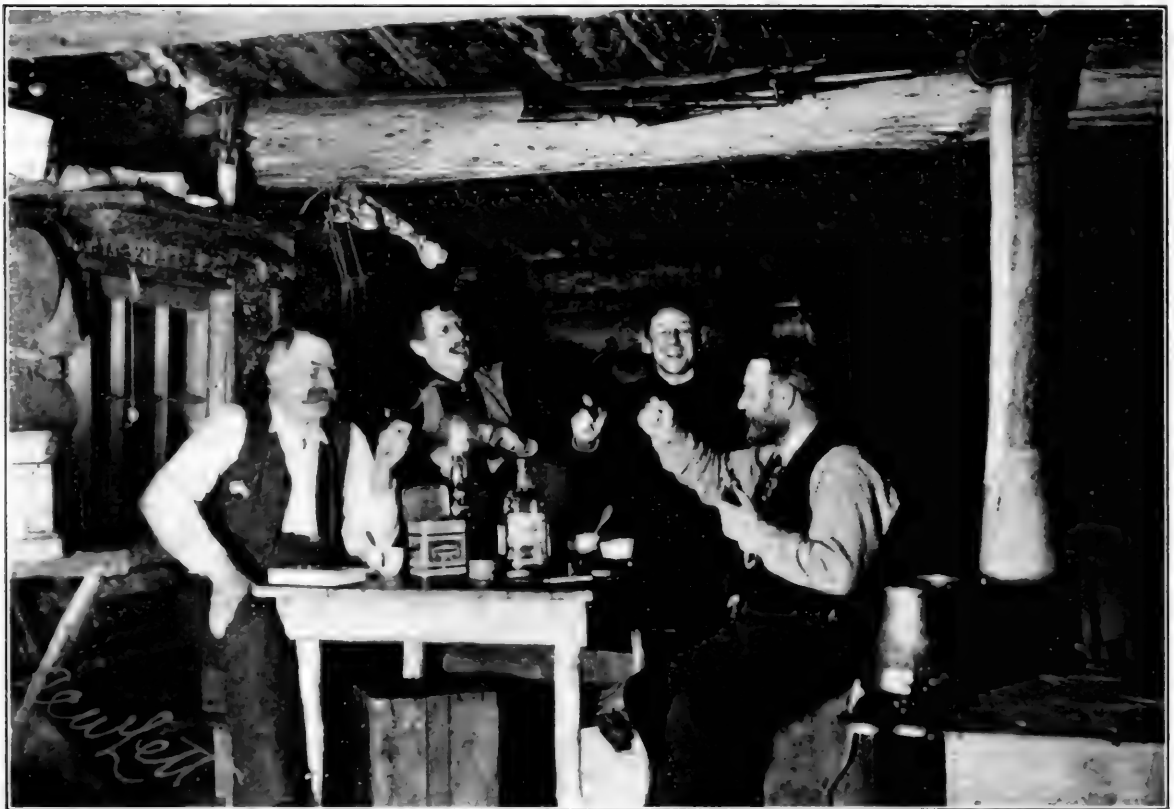

AMATEUR PHOTO BY R. C. W. LEFT.

A CORKING GOOD STORY.

Winner of 31st Prize in RECREATION'S 8th Annual Photo Competition.
Made with a Premo Camera.

Pleasant Old Gentleman—Have you lived here all your life, my little man?

Arthur (aged 6)—Not yet.—Lippincott's Magazine.

HOW TO BUILD A LOG CANOE.

G. O. SHIELDS.

It sometimes becomes necessary for men traveling in a wild country to dig out a log canoe. There are various circumstances that may overtake a man in the woods or in the mountains, and that may lead to this necessity. In other cases a man may just simply want a canoe without being compelled to have it; and if all frequenters of the forest knew how easy it is to build one, more canoes would have been made and used

I always seek the hardest work I can find when I go into the wilds, and I do as much of it each day as I can stand without collapsing. Some doctors will tell you that in exercising you should stop just short of fatigue. I do not agree with them. I make it a rule to stop just short of where I should drop dead if I kept on. I believe this is right. At any rate, a campaign of that kind, of a month, 2 months,



FINISHING OFF THE BOTTOM.

The picture was not light struck, as you may imagine. The white spot is caused by a smudge, which we had to build to keep the mosquitoes from eating us.

than ever have been. When I say easy I do not mean that a canoe can be made without shedding several buckets of perspiration; but that is good for any man. In fact, it is just what every man who has been shut up in an office needs. It is good for his soul as well as his body to go into the woods, swing an axe, pull oars, climb hills, or do some other kind of manual labor which will cause him to sweat out the accumulation of impurities in his system.

or 3 months, always puts me in trim for any other kind of hard work or trouble that may come to an ordinary mortal.

Therefore, I say that any able bodied man who may find himself in a forest, near a body of water, and who may want a canoe, will find it easy to build one.

Wright and I went to Spray lakes, 30 miles from Banff, in August last and camped near a tract of green timber. Most of the forests in that region have been



STARTING IN TO EXCAVATE THE HULL.



THE PROCESS OF BLOCKING OUT.

killed by fire, but fortunately there is a small patch of green spruce at the upper end of the upper lake in which a few good sized trees are to be found. We looked these over the second day after arriving there, and picked out a tree that was 26 inches in diameter at the butt, straight as an arrow and free from branches up to about 30 feet.

The next morning at 5:30 we sailed into this tree and in 20 minutes had it down. We cut off a log 16 feet long. Then we hewed off one side of this and made a flat, smooth surface 18 inches wide. This was

larger quantity of wood. We left about 2 feet of solid timber at each end of the log for bulkheads. This left us an open deck-way of 12 feet.

We then proceeded to cut notches about 2 feet apart, from the top of the log down to the charcoal lines on the sides. When these notches were all sunk the next thing was to split out this surplus wood. For this we made a number of wedges from a small, dead spruce we found in the vicinity. Standing on opposite sides of the log, Wright and I drove our axes into the end of the block, at intervals from the



STARTING FOR THE LAKE.

to be the bottom of the canoe, and beginning about 2 feet back at each end, we rounded off the ends from this bottom surface to the bark on the opposite side. This gave us the curves for the bow and stern of the canoe.

Then we turned the log over, trimmed off the bark on either side, at a line that would give us a depth of 16 inches for the canoe. Then with a chalk line, which we chalked with charcoal instead of chalk, we lined these sides and proceeded to notch down to them. This was a more serious undertaking than that of hewing and facing the bottom; for it meant the removal of a

charcoal line down to the deepest point of the notch, until the block had started to split slightly. Then we placed 2 wedges in either side of each block, and with the poles of our axes we drove the wedges carefully and steadily into the splits which they made. Thus we were able to split out and remove most of each block.

When the entire top portion of the log was thus removed we began excavating and removing the wood from what was to be the interior of the canoe. This required careful work, in order to avoid cutting through the shell and causing the boat to leak. We were able to remove most of



SHE FLOATS.

the timber with our axes, but occasionally resorted to the use of an adz, which Wright had taken with him for such work. We gradually dug out all the surplus wood, until we thinned the sides of the canoe down to $\frac{3}{4}$ of an inch, and the bottom to $1\frac{1}{2}$ inches.

We gauged the thickness of each side, and the bottom, by using a brad-awl with a file mark on it. This we drove occasionally from the outside until the mark came flush with the outer portion of the log. If the point showed through to the inside, we knew we were down to the proper thickness. It was an easy matter to plug these awl holes so they never leaked. We dressed the inside as well as the outside of the boat with a jack plane, and then cut 3 dry sticks, each a little longer than the width of the boat, which we inserted at intervals, springing out the sides so they would take these thwarts. When each of these was placed we drove a 20 penny wire nail through the gunwale and into each end of the stick. These were intended to prevent the sides of the boat from warping inward as the timber should season.

While resting, so to speak, we cut down a dead bull pine about 6 inches in diameter, and hewed out a neat, handy paddle.

When the boat was finished it was an easy matter to slide it over the wet moss,

a distance of about 50 yards, to the lake. As I said, we struck the first blow on the tree at 5.30 in the morning, and at 10.30 the next morning the finished canoe was in the water.

The pictures herewith show the work in process, and these, in connection with the description I have given, should enable any man who is handy with an axe to build a log canoe wherever he may need one.

We found the work really enjoyable. It is genuine fun to sink an axe to the eye in a pine log, and to throw out a chip as big as a dinner plate at each blow. Even if I could only get one day's use of a canoe, I should take pleasure in building one every time I go into the woods.

You should pull your canoe out of the water when through with it; turn it bottom side up on the bank and cover it with a good, heavy roof of either bark or brush, to protect it from the sun, and in order that some other sportsman may have the benefit of it when he comes along.

We used our canoe about a week and had many a delightful cruise in it, about the upper Spray lake. We covered it with boughs and left it on the lake shore, where I trust some reader of RECREATION may find it and may have as much fun with it as we had.

RONDEAU.

E. E. WEBSTER.

The first of May! the day, methought,
On which the festive trout are sought.

With rod of steel, and feathered hook,
I hastened to a limpid brook,
As every loyal sportsman ought,

The first of May.

A rustic lad, of books untaught,
With birchen pole by jackknife wrought,

To that same stream himself betook,
And baiting up his cast iron hook,

Began to fish without a thought,

The first of May.

A string of fish the lad soon caught;
My efforts all availed me naught;
Yet, when the townsmen came to look
Within my basket, out I took
The wondrous trout—that I had bought,

The first of May.



AMATEUR PHOTO BY FRED L. LIBBY.

RUFFED GROUSE ON HIS DRUMMING LOG.

Winner of 35th Prize in RECREATION'S 8th Annual Photo Competition.
Made with a Poco Camera.



AMATEUR PH. TO BY H. C. MARKHAM

YOUNG ROBINS.

Winner of 39th Prize in RECREATION'S 8th Annual Photo Competition.

HOW GEORGE KILLED THE BEAR.

W. S. BRITT.

My nearest neighbor at my home in Oregon is George Quinn. He is extremely fond of hunting and keeps a number of dogs for the sole purpose of catching what he calls varmints, meaning thereby bear, cougar, coyotes, wild cats and foxes. Chief among the dogs is the veteran Jack, supposedly a bloodhound, but whose ancestral escutcheon bears, I hear, more than one bar sinister. Then there are 2 younger dogs known collectively as the pups, and

ing him to bring his dogs and run a large black bear which had been seen in that vicinity. Nothing loath, George saddled his horse and leading Jack and the pups in leash, started off. About 12 miles from home, in what we call the Middle Creek country, he saw several deer, but would not shoot them. He was out for bear and nothing but bear.

Soon after passing the deer he saw a large bear cross a ridge a short distance



THE BEAR LANDED SQUARELY AMONG THE WAITING DOGS AND WAS WARMLY WELCOMED.

differentiated on occasion as this pup and that pup.

Though short on names, George is exceedingly proud of his dogs and takes great pains in their training. He deems no time wasted and no sacrifice too great that ends in the capture of any animal they will run or bay. At the approach of cold weather, with its salutary effect on pelts, he is sure to remark that "varmint are getting ripe and it's most time to pick 'em."

One day last fall he received a letter from a friend living 25 miles distant, ask-

ahead of him. The dogs scented the animal almost as soon as George saw it, and strained desperately at the leash. Hastily dismounting, George loosed the dogs and instantly they were off, yelping like a score. The bear ran as only a bear can run; and in spite of his clumsy and deliberate appearance a bear can put on a hot gait for a short distance. However, the dogs rapidly overhauled him and nipped him so sharply that he took to a tree within 400 yards of the starting point. Without waiting to fill the magazine of his rifle, George

sprang from his horse and hastened to the assistance of his canine allies.

The bear, a big fellow in fine condition and glossy coat, sat high in the tree, looking down on the yelping dogs. The first bullet from George's rifle struck the bear's skull and glanced, doing no material damage. The second shot broke his lower jaw. The remainder of the bullets in the magazine were either misdirected by the shooter or dodged by the shootee, for they could not be located at the inquest. Just as the last shot was fired the bear suddenly concluded to come down. Down he slid in a shower of bark and twigs, and George says making the most lonesome sound he ever heard. The bear landed squarely among the waiting dogs and was warmly welcomed. First a dog would nip him on one side and when he turned to strike his assailant another dog would bite the other side. This continued several minutes.

George was in a dilemma. He could not kill the bear with an empty gun, yet feared to go back to the horse to get more shells lest the bear should kill the dogs before he could return. At length the bear succeeded in catching and holding old Jack, but his efforts to bite him were less fortunate. His jaw was not in good order and the jaws of the pups prevented his giving proper attention to the work in hand.

George, seeing his favorite in danger, rushed in and, grabbing the dog, pulled him out of the bear's clutches. The veteran's injuries were trifling, and aided by the valorous pups he attacked the bear so fiercely that the latter retreated to a big stump. Backed against that he was able to stand off the dogs.

By that time George's fighting blood was thoroughly aroused. Having no better weapon he opened his jackknife, which was of generous size, slipped behind the stump and jabbed the blade under the bear's fore leg. Narrowly escaping a return blow, he beat a retreat, in the execution of which he received cordial encouragement from the bear until the dogs stopped the pursuit.

The bear returned to the stump and resumed his argument with Jack and the pups. George took advantage of that to get in another good jab with the knife. His subsequent retreat came near being disastrous, for he fell over a log and but for the interference of his faithful dogs would probably have ended his hunts then and there. However, that was the bear's last rally; he weakened rapidly and George and the dogs soon made an end of him. He was exceedingly fat and was estimated to weigh 400 pounds.

THE OZARKS.

L. C. ELERICK.

There's a place fond memory turns to,
Where the mildest zephyrs play,
'Mid the undulating Ozarks,
Where all Nature's blithe and gay;
Where an almost endless forest
Waves its arms in joyous glee,
Bidding weary city dwellers
To its glades so wild and free.

There the air is ever laden
With a fragrance all its own,
With the odors of the pine woods,
With the strengthening, pure ozone;
And there nature lovers linger,
Loth to leave those tree-clad hills
For the city store and office
And the many city ills.

'Mid those Ozark hills and valleys,
Kindly Nature smiles and rules;
There no artificial bondage
Binds the man, but Nature's schools
Brace the weary mind and body,
Rest the brain and please the eyes,
With an ever changing landscape,
'Neath the deepest azure skies.

There the rivers, full grown, bursting
From the caverns in the hills,
Rush and roar and flash and sparkle,
Cool and pure as snow-fed rills;
And the fishes, never frightened,
By the man with rod and line,
Leap and play in countless numbers,
In the shadows of the pine.

There on many a rocky hillside,
Turkeys call and ruffed grouse drum;
Myriad voices from the tree tops
Bid the nature lover come.
Bid him come, e'en though 'tis winter
And the oaks are brown and sere,
For the song birds there will greet him
Every day throughout the year.

A VISIT TO BANQUET MOUNTAINS.

JOHN W. BRYAN.

In May, just before the wet season, I started from Dagupan in a caramata drawn by an Australian ox, for the Banquet mountains. Reaching my destination at 7 p. m., I found awaiting me my friend Mr. M., who had invited me to stay a while on his coffee plantation. The 35 mile ride in a rude cart was exceedingly tiresome, though the road was fairly good.

The following morning after breakfast we paid a visit to the hot springs, and tried the famous baths. On the way we looked for traces of game, in order to be able to hunt it in the evening, as during the middle of the day game generally stays in heavy thickets. About 4 o'clock we set out, but our hunt was not successful. We heard the crowing of a wild cock, but at our approach he was quick to take the hint and kept his mouth shut and we could not trace him. All we got was a few wild pigeons.

After supper my friend suggested that we take a moonlight walk to a creek near, where we could perhaps find game. This we did, and followed the stream up 300 yards or so when my companion suddenly exclaimed, "There they are! shoot!" At first I saw nothing, but soon perceived 8 or 9 hogs of various sizes standing in the middle of the stream where the water was shallow. Singling out the largest, which was attempting to escape, my first shot broke both his hind legs. The second shot, more carefully directed, ended his career. He was a monster with extra large tusks, which I kept as trophies. We left him lying there and went farther on, got a shot at another hog as he was making for the thicket, but my aim was bad and he escaped. We came back to the one we had killed, tied his feet together, slipped a stout pole between them in Chino fashion and proceeded to camp. The hide we preserved, but only enough of the flesh to supply us and a neighboring camp a day, as meat soon spoils in this climate.

I spent enough time in those mountains to verify to my satisfaction the statement that wherever man goes the crow is sure to be present. One day, while sitting beside a mountain trail, my attention was called to a number of crows flying here and there and from tree to tree. At first I thought they were following me. All at once one darted swiftly to the ground, rising immediately, with a wild hen after him. The hen flew back to where she came from, leaving the crow apparently much excited. The crow soon darted down again and when he flew out he had something in his claws. I shot him, and found he had a small wild chicken. Even here in the enchanting region of Banquet, the paradise of Luzon, the crow persists in his barbarous habits.

Wild chickens are the most plentiful game in this province; they are found everywhere in the woods.

Once, while slowly walking through the woods, I heard the familiar clucking of a hen to her chicks. I stood still and found they were coming toward me. As it was getting dark and I was partly hidden by bushes, they did not take fright until within 3 feet of me. Then the hen flew over my head back in the thicket and the chicks disappeared as if by magic. They are wild birds in every sense of the word and it often takes a wild man to get them.

The same evening I crossed the creek where I had killed the hog, and, to my surprise, 2 large mallard ducks flew up and alighted only a short distance away. I followed them and fired, killing one on the water and the other with my second barrel as it rose.

During my stay I killed 2 hogs, one wild cat, 16 ducks, 7 chickens and a few quails and pigeons. I also killed one large snake and one lizard, or gecko, 5 feet long. After a visit of 20 days I returned to my army duties, much improved in spirits and health.

During a recent session of the House of Representatives a member intimated that the gentleman who had the floor was transgressing the limit of debate.

"I thought it was understood," said the offending member, "that the gentleman divided his time with me."

"True," responded the objector grimly, "but I did not divide eternity with you!"
—New York Tribune.



AMATEUR PHOTO BY W. STARK.

YOUNG NIGHT HAWK.

Winner of 34th Prize in RECREATION'S 8th Annual Photo Competition.



AMATEUR PHOTO BY A. J. LEWIS.

CHICKEN THIEF.

Winner of 40th Prize in RECREATION'S 8th Annual Photo Competition.
Made with a Homemade Camera.

THE CAPTURE OF A BOSS TROUT.

DON CAMERON.

Probably no fish that ever disported itself in the clear, cool headwaters of the Susquehanna ever attained greater notoriety or displayed more contempt for man and his piscatorial devices than did Squire Leggett's big brown trout.

This superb specimen of *Salmo fario*, the most vicious and gamy of all the trout family, was the sole occupant of the largest and best pool in Big creek. This pool was an ideal spot for brown trout, loving as they do to be well hid in some dark recess under a projecting bank, with swift water above and a clear pool below.

Two huge old elms towered high over the pool. The water boiling over the big stones above washed far under the trees, leaving thousands of their string-like roots awash and forming a perfect hiding place. The rest of the big hole was deep, quiet and perfectly clear.

Strictly speaking, this particular trout belonged to no one, but the Squire had first claim on him by right of discovery and he was spoken of as the "The Squire's big trout."

It was 3 seasons before this that the Squire returned from a half day's fishing with his rod in pieces and a vivid story of a terrific struggle with a monster trout which ended in the destruction of the tackle and a victory for the fish. He showed the remnants of his rod and declared the fish would go a good 5 pounds. The listening disciples of Isaac only shook their heads and remarked that the first man to tell a fish story nowadays doesn't have a ghost of a show. Nevertheless no one doubted the story, though they caviled at the alleged weight.

In the next few days all the local anglers were busy planning a campaign against the trout that was certain to prove successful, and, over their pipes, could almost hear the big fish rattling in their baskets.

During the next week many stealthy trips were made to Elm pool at all hours of day and night, with the result that another veteran angler fastened a Coachman in the fish's jaw only to lose him among the roots; and Merti saw him basking in the sun one day and established his identity as a brown trout; probably one of several big breeders planted in the creek miles below. Thus it became a well established fact that Elm pool was the home of one of the biggest and gamiest trout that ever rose to a fly. The next season he grew more wily, was hooked only a few times and got loose immediately as usual, always taking more

or less tackle with him and sometimes leaving a badly shattered rod behind. Nevertheless he was seen many times by anglers who wriggled carefully through the grass on the high bank far enough to peep into the pool. He could easily have been shot, or perhaps snared when the water was low, but like true sportsmen we did not want the fish unless we could capture him in a fair fight.

Apparently with increasing age came loss of appetite, or if he had an appetite it was satisfied with some unknown matter, as nothing in the line of bait seemed to tempt him. To us the day when the Squire's big trout would threaten the destruction of one of our baskets in his dying struggles as seemed far off as the millennium.

More than one Sunday afternoon I have lain sprawled in the shade on the grassy bank above the hole and waited patiently for a glimpse of the fish. I remember well the first time my patience was rewarded. The sun had just vanished behind the Western hills, leaving behind a clear, mellow light which penetrated every nook and crevice in the bottom of the creek, when, with a graceful, easy motion the big trout swung out from behind the roots into the middle of the pool and lay motionless within a foot of the surface. I was too surprised to move. Well hid behind a bunch of rushes I could only stare and take in every detail of his symmetrical body. His big jaws were warped with age; the lower one protruding. His mottled back had grown dark with continual hiding; his brown tinged sides were spotted with crimson and gold. The bright fins were broad and powerful and his thick shoulders spoke of great strength.

A shadow darted across the water, he was gone and I lay staring at the empty pool. As I looked, I noticed that not another trout, big or little, was to be seen, although the rest of the creek was well stocked with them.

Now this was nothing unusual, for it is well known among anglers that there is always a boss fish in every pool along a trout stream, who always occupies the best hiding place and has first choice of whatever food may wash into the pool. Frequently, if the boss happens to be an unusually large fish or an old and grouty one, he drives out all the other occupants, knowing well that there will be all the more provender for him.

As I sat wondering whether this was due to a strange preference for solitude

or to an instinctive greediness in the fish, I thought of a plan to catch the famous denizen of Elm pool. I would take advantage of this peculiar characteristic of big trout and bait my hook with another and smaller trout, and thus get him to bite from jealousy if he wouldn't from hunger. Anyway, I meant to give the idea a good test.

Next day's sunset found me nearing Elm pool. Besides the usual fishing paraphernalia, I carried a small pail containing a lively 6-inch trout.

I waded the stream down to within easy throw of the hole and deposited my pail on a flat rock. Then I gave my tackle a final examination and baited on the little trout. I must confess that I doubted the success of the experiment as I hooked the youngster through just behind the dorsal fin and watching him go wriggling down the current into the pool. The poor fellow seemed to understand his danger, for he made frantic efforts to swim back up stream. For a minute I watched the line as the bait dragged it about. Suddenly it swept toward the high bank with a strong, easy motion and I knew that something had taken the bait.

A minute passed and during that short

interval I convinced myself that the big trout had actually taken the bait but that I would never land him. Reluctantly I tightened the line and it seemed fast. I gave it a quick yank and a muffled splash answered under the bank; then with a strong pull I dragged the fish clear of the roots almost before he realized he was hooked and the fight was on.

Three times in quick succession the big trout rushed madly for the root-filled bank and as often I gave him the butt. Then came a series of terrific yanks; but the faithful old rod stood the test.

The fight in such a small pool was necessarily a close one. There was no delicate maneuvering. Neither of us gained an inch of line. I knew the fish must be well hooked and that the tackle was extra strong, so with main strength I dragged him foot by foot into shallower water and away from the dangerous roots.

Again and again he buried his head in the gravelly bottom in his frantic efforts to rub out the hook. The shallowing water hampered him in his struggles and I dragged him flopping far up the pebbly shore. His jealousy had been his undoing, and Squire Leggett's big brown trout finished his career in my creel.

SONG OF THE ANGLER

BENSON B. MOORE.

The darkness is ended
For day has descended,
And light is extended
To every small nook;
The sunlight is glowing,
Soft breezes are blowing,
And I am a going
Away to the brook.

Through the green fragrant pine
With my flies and my line
And my Bristol rod fine,
Lighthearted I stray;
'Mong the yellow broom sedge,
Through the briar and hedge,
And by precipice edge,
I go on my way.

The happy birds flitter,
They sing and they twitter,
The bright dewdrops glitter
Like gems in the grass;
The lark doth arise
From its nest to the skies,
And the hare, in surprise
Bounds away as I pass.

And my heart fast doth beat
When my dazzled eyes meet
With a bright sparkling sheet
Among the green trees;
'Tis the clear brooklet's breast
Which the angler loves best,
For 'tis here he may rest
In comfort and ease.

Here the gamy trout leap
From the clear water deep,
And the carp and bass sleep
In cavern of stones;
While the bright water plays,
In the cool shady bays
Where it murmurs its lays
In low peaceful tones.

Here the kingfishers scream,
O'er the breast of the stream,
And the dark turtles gleam
On rocks white with foam;
While the wandering mink
Glides along on the brink,
And the muskrat doth sink
To his watery home.

BUSHED.

T. J. CUNNINGHAM.

Six of the niggers had been to the camp that afternoon, headed by their chief, Paddy, and with many grimaces and gestures had made known the fact that "plenty fellah turkey set down long a' libber" near their camp. Hugh Smith was not surprised, therefore, when about 4 o'clock his mate, Charlie Field, tossed his pick on the bank and remarked that he would try to pick up a few turkeys, as their supply of meat was low. The camp was pitched a short stone's throw from their claim, and securing his gun and a few cartridges, Field was soon picking his way through the dense bush toward the river.

Hugh continued working about an hour; then, filling the billy can with water he put it over the fire to boil for tea.

Hugh had given Field's absence scarcely a thought, but when supper was ready his mate had not returned and he became anxious. The sun had gone down, and this, in Australia, is of great moment to the traveler, for with the setting of the sun complete darkness reigns. There is no twilight in this most peculiar of countries. Placing his hands to his mouth to form a megaphone, Hugh sent the Australian coo-ee ringing through the bush. Several times he repeated it, but received no answering call. He therefore ate his lonely meal, and when bedtime arrived, receiving no answer to his repeated calls, went to sleep.

The sun had already filtered through the thick bush the next morning when Hugh started in search of his partner, climbing the track which led up from the creek over steep and dangerous pinches to the main diggings 7 miles away.

After leaving camp, Field had followed the track which led to the river. Numerous cockatoos and parrots clattered along the way, but always remained out of gunshot. In about an hour he thought he must be near the river, and was preparing to descend an unusually steep slope, when, right below him, he saw a turkey dart across the track. Another, and several more followed and disappeared in a thick growth of stinging tree. To get down the slope quietly required care, but Field accomplished it, although several times he narrowly escaped dislodging loose stones which only needed the slightest touch to send them rolling among the game below.

The turkeys, ignorant of danger, were feeding on lawyer berries, which were plentiful at that season. A plump hen had just hopped on the trunk of a fallen tree and offered a tempting target. The first

shot brought her to the ground, and as the other turkeys rose with a great fluttering of wings to the trees overhead, Field shot an immense gobbler, slightly wounding him. Disregarding the other turkeys, he lined the gobbler until he saw him alight in a large gum tree some distance in the bush. Quickly reloading both barrels, Field followed on the trail of the wounded bird, taking the dead hen with him.

The bush was particularly dense in that locality, and while it completely screened him from the game, he had great difficulty in getting through it. He finally reached a point favorable for a shot, and cautiously raised his gun to take aim, but his foot caught in a creeping vine, throwing him to the ground and discharging his gun. He regained his feet in time to see the turkey fluttering into another tree several hundred feet away. The remaining shell in his gun was his last, and not wishing to lose the bird, which he knew he had already wounded, he continued the chase.

When he next got within range he was at a disadvantage, as the tree grew on the side of a steep spur and the turkey had perched in the topmost branches. Taking careful aim, Field fired, bringing the bird to the ground badly wounded but still able to hop away into the bush. Had the undergrowth been only moderately dense, the chase would have quickly ended, but favored by the tangled mass of vines, the turkey led Field a long chase before it finally became exhausted and allowed him to catch and kill it.

Field then started to retrace his steps. So engrossed had he been in the chase that he had not heeded the lateness of the hour, and night was rapidly coming on. Before he had gone far it had become so dark that he could not discern objects a few feet away. Realizing that he could not return to camp until daylight, he set about hunting a spot where he could lie down for the night. At the moment he was standing in a thick patch of swordbush, prickly lawyer and stinging tree, which precluded lying down. Advancing cautiously in search of a clearing, he had gone but a few steps, when the ground crumbled away suddenly and Field plunged headlong into space.

When Hugh arrived at the main diggings, he had no difficulty in getting a party of the miners to join him in a search for his lost mate. Taking with them a native, known as a "black-tracker," they started back over the trail to Hugh's camp. There, "Sunday," the native, was given the lead. Taking the trail where Field left the camp, he was off



AMATEUR PHOTO BY U. C. WANNER.

RAIL SHOOTING ON THE SUSQUEHANNA.

Winner of 1st Prize in RECREATION'S 8th Annual Photo Competition.

like a bloodhound on the scent. Up to the point where Field had first sighted the turkey, the aborigine followed the regular track unhesitatingly, only once or twice stopping a second where Field had wandered from the track. As the party reached the summit of the slope which Field had descended the previous evening, the native dropped on his hands and knees and carefully examined the ground. Suddenly he straightened up, and holding out the palm of his hand, displayed a little roll of partly burned tobacco.

"One fellah Charlie no finish smok'. Empty pipe clos' up here, quick fellah."

That was the native's way of telling the others that Field had, on first sight of the game, stopped smoking and possibly shaken out the contents of his pipe.

The tracker descended the slope, carefully watching the ground and the bush on either hand. Coming to the point whence Field had first fired, he plunged directly into the bush. It was then plain sailing for the native. One can not pass through the thick bush of tropical Queensland without bending or breaking numerous vines or bushes that impede his progress. To the native this disturbed undergrowth was as plain as so many tracks in the snow.

Making his way directly to the fallen tree where Field had shot the first turkey, he pointed to where the scattering shots had ripped up the bark; then examining the grass closely a moment, jerked out, "Catch him one fellah turkey here."

He jumped over the prostrate tree, and led the way deeper into the bush, the miners having difficulty in keeping him in sight, so rapidly did he pass through the tangled brush. For about half an hour they traveled in that manner, the trail, toward the end, twisting and turning in every direction. Suddenly the nigger stopped and held up his hand with the exclamation, "What name!" This is the native English for "What is that?" None of the party had heard any sound to arrest their attention while breaking through the bush, but then all listened intently. A faint cry for help reached their ears, coming from a point immediately to the left. With one accord they rushed in the direction of the sound, in their excitement tearing their hands and clothing, with the sharp sword grass and lawyer vines. A cry from Hugh, who was in the lead, checked them in their headlong rush. He had barely escaped falling over a steep bluff, the brink of which had been hidden from view by the thick bush. Part-

ing the bushes, the searchers peered down on a most unusual sight. The sides of the bluff went straight down to a depth of 30 feet, ending in a fairly level terrace, thickly covered with lawyer and stinging tree. Tightly imprisoned in a giant lawyer bush, its thorn-covered vines wound round and round him, was Hugh's lost mate.

The tracker was not long in finding a point at which they could descend to the terrace below. Five minutes later, sturdy arms had cut the wirelike vines and extricated Field from his terrible position. He had fainted before they could release him, and little wonder, as it was an hour past noon, and he had lain in that position since the previous evening, with his arm broken by the fall.

The rough miner of Australia has many times had to act the part of surgeon, and when Field opened his eyes it was not so much the effect of the whisky which Hugh had forced down his throat, as the pain caused by 2 of the diggers in roughly setting his broken arm. In a remarkably short time they had the injured member bound with splints. Although weak and still suffering intense pain, Field was able to give the party an account of his accident, while the native started a fire and boiled the billy.

When Field fell over the bluff, his foot had caught in some vines, throwing him head foremost, and he had landed on his left shoulder in the center of the lawyer bush, breaking his arm and frightfully lacerating his face and hands. With his right hand he attempted to free himself, but at every move the octopus-like vines wound tighter and tighter about him, until he was pinioned fast. In this way he passed the night, twice fainting from the pain and horror of his position. When daylight came, he made frantic calls for help, but with little hope of being heard, as the position in which he lay prevented his voice penetrating far, even should anyone be in that locality. Had not his faithful mate been so prompt in making a search, the dangerous vine would surely have held a corpse before the sun had set.

After all hands had eaten their lunch of damper and tea, they rigged a rude stretcher of saplings and carried the injured miner back over the long, tedious trail to the main camp. A week later he was taken on horseback to Geraldton, where, at the hospital, he received proper medical attendance, until he was able to return to the bush.



AMATEUR PHOTO BY O. J. STEVENSON

FAMILY OF SCREECH OWLS.

Winner of 38th Prize in RECREATION'S 8th Annual Photo Competition,
Made with a Poco Camera.



AMATEUR PHOTO BY E. W. EDINGTON.

GOOSE SHOOTING ON THE BIG SIOUX.

Winner of 32d Prize in RECREATION'S 8th Annual Photo Competition.

THE GREAT TROUT.

HENRY CROCKER.

A versification of the trout story, entitled "Crocker's Hole," by R. D. Blackmore, in "Slain by the Doones."

The trout stream, winding through the mead,
With shallow current flows,
A ribbon blue, with broidered edge
Of fern and crimson rose;
Till, deepening where the banks approach,
Above a ledgy slide,
It runs, a laughing, foaming flood,
A swift, tumultuous tide.
Then where an ancient alder tree
Inclines above the stream
It turns, and lapses into calm,
As placid as a dream.
There in a pool, secluded, deep,
A cool and shady nook,
Once lived the largest, lustiest trout
That ever scorned a hook.
Where first the noisy current meets
The quiet from below,
He held position dignified,
With motion calm and slow.
But only angler's vision keen
Could see the tempting prize;
The moving, bending waters blind
All unaccustomed eyes.

A little younker I was then,
Too small to cast a fly;
I fished with pins for little fins
Not large enough to fry.
John Pike, a burly, blue eyed boy,
I followed all about;
He went a-fishing every day
And Sundays thought of trout.
"Come now and look into the brook,"
One day John said to me;
"Don't hurry, stupid child, kneel down
And tell me what you see."
The sparkling waters blind my sight;
The wavelets twinkle so,
I see the flashing crystals dance,
But nothing down below.
When suddenly a May fly comes,
A gray drake, rich and gay,
With dart and leap above the pool
Begins a game of play;
Rising and falling like a gnat,
Thrilling her gauzy wing,
And arching her pellucid frame,
A truly luscious thing.

"He sees! He'll have her sure's a gun!"
Cries John, with gulp of glee;
"Now can't you see him, simple one,"
"If not what can you see?"
"Crickety Crocums!" I exclaim,
With classic language free,

"I've seen that thing a long time back,"
"But thought it was a tree."
"You little gump! Don't stir a peg"
And see him take that fly."
Swoop comes a swallow as we gaze,
But missing, glances by:
By wind of flight, or skirr of wing
He struck the dancer brave,
And falling, for an instant brief
It flutters on the wave.
Then swallow—swift, but far more true,
The great trout makes one spring,
And quick as lightning, out of sight
Has snapped the shining thing.

Sound deeper than a tinkling stroke
But silvery as a bell,
Rings through the leafy arches now
The poor ephemerid's knell!
The waters scarcely show a break,
Save a bubble sailing nice;
And softly echoing woods prolong
The music of a rise.

"He's shown me how he takes a fly,"
Says John, "and he shall rue it."
Have him I must and will, and now
The question's how to do it.

John Pike, a genuine fisherman,
Can think of nothing now
Except that mammoth handsome trout
Beneath the alder bough.
With calm absorption of high minds,
Intent on timely flies,
With cobbler's wax, and flossy silk,
Creation's art he tries.
As poet labors at his lines,
Compressing thoughts of joy
Into the compass of few words,
So toils the patient boy
About the fabric of a fly,
Comprising all the grace
That ever sprang from maggot foul
Into a fairy race.

When of the spring and summer fair
The honeymoon draws near,
Marked by the budding of the rose,
The burst of bright wheat ear,
The feathering of the plantain plume,
And flowers in meadows sweet,
And, foremost, for the angler's joy,
The waltzing May flies meet,
The rivers should be warm and mild,
Skies blue and fleecy white,
The west wind blowing soft and low,
Trout hungry for a bite.

On such a day, with thumping heart,
 John ventured near the brook,
 A Yellow Sally, true to life,
 A-dangling at his hook.
 It fluttered gaily on the breeze
 In such a lifelike guise
 A sister Sally came to see,
 And went away more wise.

Up through the branches on the brink
 With Zulu skill John trod,
 To where a yard-wide opening gave
 Just room for spring of rod.
 Below John saw the friendly fish
 Swaying his tail about,
 As men who, dining with a lord,
 Their restless coat tails flout.
 With dextrous twirl, untaught by books,
 John laid his pretty fly
 As lightly as a gossamer
 Before the great trout's eye.
 Without a pause, as quick as thought,
 The thing that happened came:
 A heavy plunge, a fearful rush
 And then began the game.
 The river's current ridged as if
 A plow was driven below;
 The reel set up a lively song;
 The rod bent like a bow;
 Twanging like a harp string tense
 The strong line cut the brook.
 Snap goes the foolish hollow rod!
 The trout is off the hook!

"Bad luck," cries disappointed John;
 "But never mind, old trout,
 Just take it easy for awhile,
 Next time I'll have you out."

The genuine angler's mind is large:
 'Tis steadfast, finely poised;
 It heeds no more a vapid taunt
 Than wind or idle noise.
 In mocking tones the people cried,
 "Pike, have you caught him yet?"
 And Pike but answered patiently:
 "O you just wait a bit."
 He made himself a splice rod, short,
 Well seasoned, stout and handy,
 With tapering tip of fine bamboo,
 Well balanced, just a dandy.
 "Now break it if you can," said he,
 "By any sort of trick,
 "Whatever other game you play,
 You cannot break this stick."
 He made besides a landing net,
 Of stick, a wire ring,
 A netted bag with meshes fine,
 Of strongest cotton string.

About the second week in June,
 May flies had danced their day,
 The wounded trout had ceased to pout,
 And ventured out to play.
 Then came a gentle rain by night
 With pleasant tinkling sound,

Pattering among the tender leaves,
 And moistening all the ground.
 Then John come whispering to me,
 Hard panting from a run,
 "Now when the water's clear, my boy,
 There's going to be some fun."

All lovers of the rose know well
 A beetle bright and gay,
 That joys among the petals deep
 To hide himself away,
 Until some breezy waft reveals
 His back of emerald hue,
 And all his front, red Indian gold,
 And white spots peeping through.
 John with his finger and his thumb
 The sparkling vandal took,
 And offered him a change of joys
 Upon a limerick hook.
 He liked it not, but pawed the air,
 His bright wings vainly flew.
 Said John, "If he but works like that
 When in the brook, he'll do."

Then calm, deliberate, self-possessed,
 And free from trembling nerve,
 John stepped upon an alder bough
 His tempting bait to serve.
 The pretty beetle on the waves
 Commenced a lively tread,
 More active far than when ensconced
 Within the roseleaf bed.
 To hungry fish it seemed quite sad
 To see the fair thing drown,
 And mercy, if not appetite,
 Suggested, "Gulp him down."

"I've hooked him in the gullet, sure!"
 Cried John, in accents plain.
 "Now then, if I don't land you, sir,
 I'll never fish again."
 With rod in bowlike springel rise,
 And line like viol string,
 Winch galloping like harpoon wheel,
 Brave John rules everything.
 He dashes in through thick and thin,
 Now in the stream, now out;
 Towed by the fish from pool to pool,
 A desperate, scrambling rout.
 I tell you, for it comes again,
 As if 'twere yesterday,
 I was so scared it seemed my wits
 Were everyone away.
 I hollaed; but this thing I did,
 As if my nerves were steady;
 I followed close on John Pike's heels
 And held that scoop net ready.

"He's well nigh spent, I do believe,"
 Said John, with voice like balm.
 We'd reached the meadow, far below,
 On Farmer Annings' farm.
 "Now take it coolly, my dear boy,
 And bring the landing net.
 If he gets on another rush,
 I fear we'll lose him yet."

How one should use a landing net
 I'd not the slightest notion;
 But John, a mighty general,
 Directed every motion.
 "O, don't, don't let him see it, Dick,"
 Go under, stupid one.
 Just bring it up his back now; good!
 You have him, boy, well done!
 Now hold the rod, I'll lift him out,"
 My happy master cries.
 I willingly resign the net,
 And let him take the prize.
 With open mouth and straining arms
 He makes one mighty sweep,
 And flapping down between us falls
 The giant of the deep.
 We fall beside him in the grass
 And laugh and shout for joy;
 The happiest lads in all the land
 John Pike, and this small boy.

The beauty of that mammoth trout
 I never shall forget.
 As if it were but yesterday
 I seem to see him yet.

His head was small, his shoulders vast,
 His back was gently bowed;
 His belly's deep, elastic sweep
 His generous nurture showed.
 His eyes with vibrant vigilance
 Seemed watching for surprise;
 His every movement seemed to say
 That he was strong and wise.
 His latter end was shapely built.
 His counters tapered true,
 To where, like spreading swallow tail,
 His huge propeller grew.
 His color words can scarce describe;
 It seemed to tone away
 From green and brown with crimson stars
 To gold and silver grey,
 All mantled with a subtle flush
 Of opal, fawn, and rose,
 And all the iridescent tints
 That pearly shells disclose.
 Its length, its weight you want to know?
 Spare me, my loving friends;
 I know just where your doubts begin.
 And here my story ends.



AMATEUR PHOTO BY JOHN N. FISHER, JR.

AT BREAKFAST.

Winner of 13th Prize in RECREATION'S 8th Annual Photo Competition.

"Mamie got a diamond ring Christmas."
 "How did she get it?"
 "Hung up her stocking."
 "Jack, of course? But how did Jack
 get it?"
 "Hung up his watch."—Illustrated Bits.

THE HUNTER'S DUEL

STANLEY MAYALL.

Cultus Jack and Klondike Jim were rivals in more ways than one. Cultus means no good, and Klondike means a lot that is bad. Nevertheless, both men, tall, sinewy, handsome and fearless, had much in them that even Western boomers found time to admire and at least one Western woman heart enough to appreciate. Fire Gulch was an aggregation of weather-beaten shacks which had sprung into existence in a day in consequence of a placer digging rush. It had been later sustained by discovery of mineral in place, and was now having a third period of prosperity, owing to construction of a railroad and consequent disbursement of money to the men employed.

Cultus Jack was one of its oldest inhabitants; Klondike Jim, an unsuccessful Alaskan digger, was a newcomer. They were trappers and prospectors. Cultus used a 45-90 and had once killed 8 bears in one week.

The afternoon Klondike Jim arrived in town he had pointed his 30-30 skyward at a flock of traveling geese and with 3 consecutive shots dropped the bugleman and both his flankers. The street loafers stared. Cultus Jack, who had hitherto held pre-eminence as a marksman, muttered much strong language beneath his breath, and from that moment looked on Klondike as a personal enemy.

It did not improve matters when Klondike commenced to pay particular attention to Kitty Connor, the daughter of the lumber mill owner. She was a handsome girl, sloppily dressed, perhaps, and badly brought up, but she was straight and had for months been considered Cultus Jack's special property. When he saw Klondike Jim taking mountain grouse to her father's house he did not like it. He liked it much less when he discovered that each of those grouse had been most scientifically beheaded.

Jack hardly knew whether he hated Jim most for liking Kitty, or for shooting the grouse in such faultless fashion. He was becoming vaguely aware that Klondike might eventually prove both a better marksman and a more successful wooer than himself. In a one-horse town like Fire Gulch that would be intolerable; everybody would know it, and all who dared would remind him of it.

Week by week things got worse. Kitty seemed to take pride in playing the 2 men off against each other. Klondike's distrust of Cultus turned to dislike, dis-

like to hatred and hatred to suppressed fury. One day the storm burst. The town was celebrating the return of a noted schemer who had just floated a group of wildcats in the European market. Horse races, rock drilling and rifle shooting contests had been held. Cultus had backed the wrong pair of rock drillers, his horse had been easily outrun and then, to his intense disgust, he had been beaten in the rifle match; beaten by Klondike Jim, before the whole city and Kitty Connor.

He was for a time speechless with rage; then although he had already drunk enough he imbibed some more 40 rod whiskey, which loosened his tongue and fired his mind. He was heard to declare he would be durned if he believed that popgun shooter ever hit any thing bigger than bull's eyes or grouse's heads. Jim who had just entered the saloon heard him.

"Guess I hev," was his quick retort, "and may hev to again."

"Was they jack rabbits or gophers?"

"No! They was men, and Indians, and sich."

It was a direct challenge, there was no mistaking it. A sudden silence fell over the saloon. A man who was bucking a slot machine, with the usual bad luck, turned uneasily and looked for the best way out. The card dealing and dice throwing ceased and the gamblers shifted their feet nervously on the bare floor. Those at the bar lowered their glasses silently as if to draw no attention their way; and the barman stepped opposite the spot where his trusty Colt lay handy on a beer-stained shelf.

Cultus Jack felt himself the cynosure of all eyes; his lips twitched. Ripping out an oath, he retorted:

"There's one man you'll never face on that kind of proposition, you Siwash!"

"An' who's thet?"

"Me, you interlopin' skunk."

"Look here, Cultus," Jim replied, moving closer, "I'll face you on that kind of proposition whenever you please, an' the sooner the better fer me,—an' enuther party concerned."

Cultus Jack's face whitened at this public and confident reference to the other party concerned—Kitty undoubtedly. He contented himself by nodding affirmatively. Klondike's face lit up with a glare, as when in the hills, with rifle extended, his eye glancing through back sight distinguished the bead in line with his quarry's heart or head.

"I'll meet you," he said slowly, "to-morrow morning at 4 o'clock at the unfinished bridge. You take one bank, I'll take the other; you use your old cannon and I'll use my popgun with 3 shots inside and no more. At pistol fire we start toward each other on the top plank. If either fires before he reaches the end, the spectators is at liberty to blow hell inter him. Missouri Bill and Roughlock Harry will stand by to see fair play, an' invite everybody to be present and keep their mouths shut."

The challenge was as direct as the test was appalling. The bridge was over 150 feet high and 1,500 feet long, a huge skelton-like trestle needing several weeks' labor before completion. Right in the center was a gap of 300 feet awaiting the arrival of stringers from the coast before it could be filled in. To reach the gap the rivals would have to walk an elevated pathway of 8 inch planks laid end on, not too securely, and which, at the height of 150 feet would prove impassable to 99 men out of 100.

All eyes turned on Cultus Jack. He braced himself, but with all his pluck he had not pluck enough to refuse the challenger.

"Let her go at that," he said. "It's a deal. I pass the bill as read."

At that moment an old prospector, who had mined from Mexico to Alaska and made and lost fortunes entered the room. He was known as Crazy Jones.

"Boys," he said, "I've had the durndest scarin'. I left my cabin up the hills at daybreak, intendin' fer to come here an' celebrate, an' pears ter me I've been celebratin' ever since. I found all the cricks up and all the trail bridges gone out. Doc, my old hoss, is dead in 10-mile creek. On 7-mile I lost my rifle; my grub had gone already. I come on as far as Silver creek and was a sittin' dryin' myself and thinkin' gen'rally and swearin' particularly, when I heern some slow heavy movin' brute crashin' through the scrub below. Thinks I, that's a b'ar; I'll chuck 'im a rock. So I picks up a nice bit of quartz, gives a yell and lets him have it. Bar? Waal, I should say, an' a grizzly at that; the biggest, ugliest brute I ever seen. He sailed up that hill like a big brown whirlwind; he was mad an' he was hungry an' I guess he was celebratin' too. I run, boys, run till I tore my clothes, lost my hat and got scratched worse than a Derby favorite. But I left him all right. Just wait till to-morrow, I'll borrow Klondike's dog and Cultus Jack's gun, an' let lead an' light an' larnin' into that dog-gone brute."

Late that night Klondike Jim and Cultus Jack happened to meet. The former hesitatingly made a strange suggestion. "Jim," he said, almost blandly, "ef it's just the

same to you, we'll hev' that shootin' scrap a day later, instead of to-morrow; for one thing, I've got some important business, an' for another"—hesitatingly—"you'll be fitter yourself."

Cultus Jack looked straight into his opponent's eyes. He saw no sign of cowardice there and guessed the important business; well, he had some himself.

"All right, darn yer," he replied, "let Roughlock Harry know, and ye needn't think I can't hold my liquor."

Nevertheless before tumbling into their bunks that night, each of them cleaned his rifle, and Klondike scribbled a note to Roughlock Harry announcing the postponement.

Unfortunately owing to continued celebrating by the messenger, the letter was not delivered, and for a like reason Crazy Jones did not set out to hunt the grizzly.

Early next morning, a small crowd gathered near the bridge. Four a. m. came and passed, and no combatants. Five o'clock and still the rivals were absent. The crowd waxed impatient; a horseman galloped off, and returning, reported:

"Neither one nor 'tother kin be found. They've both funk'd it, I s'pose, and skinned out. Let's go home, rot 'em."

Old man Connor took it badly; his daughter took it worse. The fall to her pride confined her to her home a week.

Crazy Jones came once more to town, looking more scared and worn and haggard than before. He had with him the biggest grizzly hide ever seen and a shocking tale to tell. He had seen bear sign and followed it; to his intense surprise had come on a gigantic bear lying stone dead. It had been dead some days and the pelt was worth but little. In the skinning, he found bullet wounds in 2 places; one through the thorax and another through the heart. He thought it strange the hunter had not bagged his quarry. Later, on going for a drink at a neighboring creek he learned why. There he found Klondike Jim lying lifeless and an examination showed he had been dead some days. A rifle ball had smashed his left hip; he had dragged himself to the stream and there died. In his clenched hand lay a note.

"It was a accident. We heard Crazy Jones tell of a bear. Jack mus' have krep' up the other side of the creek is I kem this. I never knowed he was thar. We both fired symultanyus. He mus' be down to; he yelled once and aint moved since. The bear's O. K. too. Love to Kitty. It's better this way than on the bridge, it aint—"

The scrawl, evidently written with great difficulty, gradually flickered away as the

hand that traced it and the brain that dictated ceased forever their life's work.

The note set Crazy Jones moving. He heard a dog whine, and a few minutes later found the body of Cultus Jack guarded by his hound. He had been shot through the head, and death must have been instantaneous.

Here was a strange medley of fatalities. Two shots only had been fired; the hunters had both hit their quarry and killed

one another. The bear had probably windced his enemies on either side, adopted an exposed intermediate position and fallen at once fatally wounded.

Then Klondike Jim's messenger remembered the forgotten note, and its production saved the dead men's honor. Later, Crazy Jones had another piece of mining luck. He staked a claim, called it the Grizzly Bear, got it bonded and within 6 months married Kitty Connor.



AMATEUR PHOTO BY THOS. C. MARTINDALE.

GOOD-BYE TO TRAINS FOR 30 DAYS.

Winner of 18th Prize in RECREATION'S 8th Annual Photo Competition.

BABY POLLIWOG.

FRANK H. SWEET.

Splashing about in a pool in the bog
 Is a gay and happy young polliwog,
 His young frog heart full of joy and doubt
 Of all the wonderful things about;
 But biding his time
 Till his 'wogdom be past,
 His nursery left
 And his funny tail cast,
 His knowledge enlarged,
 And his legs uncurled,
 And he can go hopping out into the world.

ALPINE ANIMALS IN COLORADO.

W. H. NELSON.

The Easterner who, in quest of health or pleasure, becomes a resident of the Colorado Alps will find many new and interesting forms of animal life whose habits he may study, and whose friend he is sure to become if he have in him the spirit of the woods.

It is my lot in these latter days to occupy a cabin amid the peaks of the Rockies, where, if one be a worshipper of Nature, he finds himself in her temple, indeed. Northward the lofty peak to which Lieutenant Long gave his name rears itself a sovereign among giant subjects, its silver crown sometimes glistening under the rays of the sun, sometimes hidden within a cloud. Hidden, however, or revealed, the peak is always sublime. Westward Arapaho towers, almost as lofty as Long, while to the South stand Chief, Squaw and Pappoose, grim sentinels, unchanged and unchanging when those whose wigwams once held the people who named them have passed away forever. The animals that choose their home in such a region must be unlike their cousins farther East and on lower land.

When the first level beams of the sun set the frost a-glittering, out from beneath my cabin comes a tiny chipmunk. He is a lightning streak for 5 or 6 feet, then stops and up-ends himself, jerking his funny little scraggly tail and cocking his weather eye at me, as much as to say: "Well, old fellow! How do you find yourself this fine morning?" He is about the same size as the similar animal in the East, but differently colored. The ground color of his coat is cream, the stripes quite dark. He has much the same disposition as his Eastern cousin, curious, timid, venturesome. If I remain still he will sit as if carved from a striped stone. If I move but a hand, however, he is back to his den, from which I soon see the dainty nose protrude. He is scouting, and will come on or go back as I stand still or move. No amount of surreptitious feeding seems to overcome his suspicious timidity, no number of alarms to drive him from his home.

Where a massive rock projects above the level of the cone not far from the cabin a rock squirrel has his tabernacle. Tiny and quick, nimble and inquisitive, he is like a little boy of the family of squirrels, but chain lightning would have to get a wiggle on it to catch him in a square race. Everything about him is in miniature and his diminutiveness is grotesque.

The earth in the little parks is as full of holes as a pepper-box lid. Little gopher

mounds are everywhere, while the ground under the surface seems a labyrinth of galleries and dens.

In the cliffs not far off, the coyotes have their dens. Every night, when the business of the ranch has been suspended, and the passing of the domestic animals to and fro has ceased, the father and mother coyotes put their babies to sleep, slip out softly and steal away to the cadaver of an unfortunate cow not far from the cabin. She has grown ripe, too ripe, indeed, when the wind is in that quarter. Other couples come from other coyote castles, and as they wind their various ways toward the feast, each couple in turn sits down and sounds a call which is answered from all around.

One of these serenaders will sound her call no more, and her children, doubtless, have died for lack of food. As the ranchman, whom I shall call Leon, passed through part of his land, a favorite spaniel came yelping and running for dear life to the wagon and took refuge under it, with a coyote nipping at his heels. Had he been farther away when the race began poor Nigg's book had been closed, for he was much too small and too silky to withstand his rugged antagonist. With the next load the boy Aden was sent to invite me to take the Remington and go along. I did so, trusting No. 3 to Aden to carry, the asthma claiming all my attention. We went out on a 4-horse wagon, Leon and I on a seat at front, Aden and No. 3 standing farther back. All at once Leon pulled up the team, saying, "Gim me the gun! There she is!" Glancing to the left amongst the pines I saw, sure enough, the flitting gray shadow. It stopped facing us, its fiery eyes fixed on poor Nigg, who trembled in his refuge beneath the wagon. The range was short—not over 25 yards, the shot easy, the trees open, and in an instant 250 grains of lead bored a hole through the glaring breast—endways. It entered in the right breast, passing slantwise through the internal machinery, and out in the left flank. She turned a back somersault and ran about 200 yards. When Leon reached her she was dead.

I have, in my time, shot many rifles, and some of them favorites at the time, among others the old English Enfield, in the interesting shindy kicked up by our unruly brethren of the sunny Southland. The Winchester, the Stevens and the Ballard I have used, and I hope to be forgiven by the brethren of the trigger, if I say that the Remington satisfies my longings as nothing else can

do. I got it for target use, but it gets there on game just the same.

I am in correspondence with the Malcolm telescope people, advertisers in *RECREATION*, and shall presently get them to mount me a scope on my faithful Hepburn. This will give me a new lease on my eyes. I have talked also with the Remington people and shall have them put me up a supplementary barrel, 25-20 Stevens, which, on occasion I

shall substitute for my 38-40 Remington. Then I can shoot in the Maryland woods without danger of killing some man's cow in the next county. If I ever come to Colorado again I hope to bring for use in the woods a Remington-Lee sporting. It is the truest, smoothest shooter, and the hardest hitter among the modern high power guns, and withal is shapely to the eye and light to the carrier.



PRESQUE ISLE RIFLE CLUB, ERIE, PA.

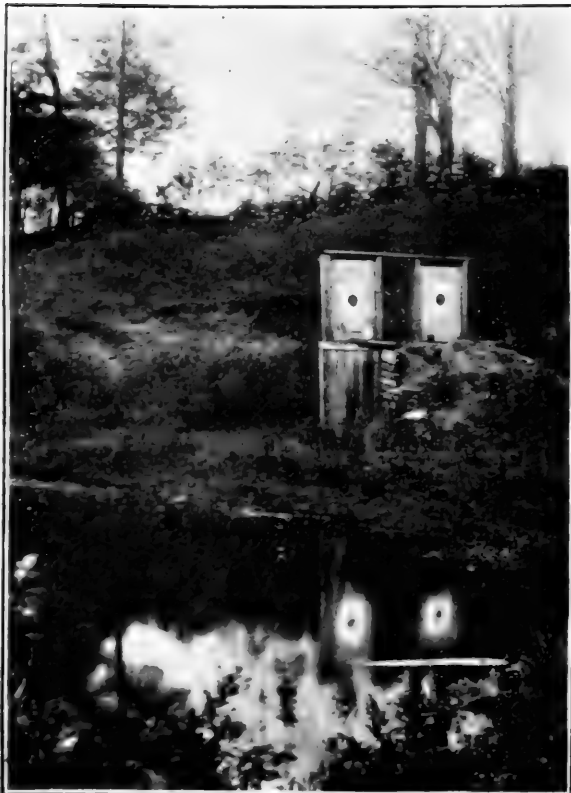

AMATEUR PHOTOS BY W. A. PARKER.

200-YARD BUTTS, PRESQUE ISLE RIFLE CLUB.



BARREN GROUND CARIBOU.
(*Rangifer Arcticus*, Rich.)

From Circle City, Alaska. Length of main beam on curve, 54½ inches; greatest spread 36 inches; total points, 16. Owned by G. R. Anchors, Wash., Pa.

Editor (of magazine)—What's the delay about my getting in?

St. Peter—You paid on publication, didn't you?

"Yes."

"Well, some of your contributors are inside and I've agreed to let you wait until all their stories have appeared."—Exchange.

A COCONINA SQUAW

ALICE R. CRANE.

One day while my son Fred and I were traveling through the Indian country of Arizona, we stopped at a trader's store at Fort A—for supplies. While waiting on the long porch of the store, I noticed a miserably dressed, hungry looking squaw, having in her arms a pappoose about 10 months' old, which was wrapped in a dirty, ragged blanket. The squaw was crooning a song to her child in her own language. I did not know to what tribe she belonged, and spoke to Fred about it. His curiosity was also aroused, and his heart went out to the woman in her pitiable condition.

"Mama, I am going to ask the trader to

The rough trader came to the door, and on seeing the woman, started toward her, as if to kick her off the porch. Addressing her in Spanish, he told her to be gone. When she started to go, we interfered.

"These creatures," he said, "are hanging around here all the time. I didn't know she was here, or I should have driven her off.

At last we made him understand that we wanted him to let the squaw stay, and asked him to call her back. He did as we wished, but scowled while doing so. The poor wretch came slowly and suspiciously up to her old seat.

"What tribe does she belong to?" I asked.

"She is a Coconina, a small tribe above Flagstaff. During their hunting trips they straggle in here. They are many miles from home, the miserable wretches, and I wish they were all in the Kingdom Come or some other place."

The squaw again began to sing to her child, rocking herself back and forth.

"What does she say in her song?" asked Fred, with tears in his innocent eyes.

"Do you really want to know?" he asked, smiling at the boy's earnestness.

"Yes, please translate her song, won't you," said Fred. I joined in the request, and as he translated the lullaby, I wrote it down.

"Your papa's away on the mountains,
To hunt food for baby and me.
Mother and baby go hungry
Since the white man has come here to stay.

The game that once was your papa's,
The white man now claims as his own.
The Indian is robbed of his pleasures,
The deer and the antelope gone.

Papa's wife and pappoose must go hungry,
Though between moons be ever so long.
The buffalo, too, has been slaughtered;
Our people's been awfully wronged.

May the great Spirit that now watches o'er
us

Take the white man away from our home."

Fred could stand it no longer. Wiping the tears from his eyes, he took the trader, who was laughing at the boy's tender-heartedness, by the arm and went into the store. He soon reappeared with a sack of food, which he gave to the Indian woman.

I felt that something was wrong about the Indian question, and some one would have to account some time for all the mistakes made. The Coconinas are a self supporting tribe of about 150, and have never asked nor had Government aid. They live in a timbered country, not far from the Grand canyon. They are seldom heard of unless some one stumbles on them, as we did.

An old pioneer told me that some 30 years ago he ran across this tribe, numbering about the same as now. He had with him some small mirrors, for trading. The Coconinas received him kindly. He told them he wished to give every babe in the tribe a glass.

Babies galore were taken to him, one at a time, until he became convinced that every man as well as squaw, owned a pappoose. By watching, he found that when one pappoose received a mirror, the child was at once transferred to another squaw, who produced it again as a new applicant for a glass. So did the wily red people outwit the trader.

Tommy—Ma, may I have Jimmy Briggs
over to play on Saturday?

Mrs. Fogg—No, you make too much
noise. You'd better go down to his house
to play.—Exchange.

CAMPING AT INDIAN LAKE.

THOMAS A. BENNETT.

Our idea of camping on Indian lake, 2 miles from Millerton and 100 miles from New York City, was born 3 years ago when my fishing chum, John Campbell, set out to look into catalogues and camp cook books. During most of one winter he lay awake half the night making up a list of articles needed. Abercrombie & Fitch were selected to outfit the now famous Camp Edna. John is a systematic and thrifty chap, and nothing was too good for him, so in due course of time our temporary headquarters on a farm near Millerton was packed with waterproof tents, aluminum kitchenware, sheet iron stove, collapsible cots, chairs and tables, blankets, etc.

I left New York a few days ahead of schedule time to select a spot near the lake where we could pitch our tents for one week. I found a little eminence in the woods partly cleared, with a spring of excellent water near. With the help of an ax brigade, I soon had the stumps leveled, and by cutting a trail to the lake was enabled to save many steps for our party.

As Saturday, August 30, 1902, approached everything was on edge pending the arrival of John, Winnie Smith, Bob Walker and Dick Pate from New York. Orders were given for a side of bacon, 10 pounds of salt pork, $\frac{1}{2}$ barrel of beans, 6 packages of prepared flour, 5 hams and unnumbered sundries. Our friends' arrival was a signal for a genuine war whoop. Proceeding to our storage warehouse, the hard, but pleasant work of going into seclusion and camp began. Loading our stuff on a large lumber wagon, and our new skiff on an extra wagon, we set out amid cheers and well wishes. Reaching the site about 3 p. m., we got the sleeping and kitchen tents ready and gathered a quantity of wood. John insisted on having coffee at once. Following our attack on the larder, lights were extinguished and all slept except the mosquitoes, our first visitors in camp. I am inclined to think Winnie Smith, who came from New Jersey, unloaded them on us.

At dawn I arose, dressed, gave 3 long blasts on the horn and the boys were wide awake. It was Sunday, but we resolved

to lay in a good supply of wood to feed 2 fires and cook enough to satisfy our appetites, which increased alarmingly. It required 3 cooks to keep the pot boiling. The rest of the camp chased after wood and water. It seemed as if that day we did nothing but eat, drink and wash dishes.

Monday morning we prepared to do some tall fishing. Soon after breakfast we put our rods in shape, gathered a quart of crickets and went down to the lake. We had no sooner left our anchorage, having concluded to troll a few minutes, than Winnie struck a 2-pounder. The water was just right for bass fishing, having a gentle ripple. We were favored with good sport and landed enough bass for our table that day with a few perch thrown in, the bass weighing one to 2 pounds each. Tuesday morning we again tried the bass grounds in the lake. I soon had a tremendous tug with not over 15 feet of line out and began to reel in my short slack, calling to Smith to get the net. The bass came in sight once and was gone, a 5-pounder at least. We tried another spot and in an hour had landed 7 good sized bass. This took us to dinner time. We rowed back to camp and found lady visitors in possession, John's better half and friends. They volunteered to do the cooking and wash the dishes. As they were unable to go home so late, we gave them our sleeping tent, and improvised a blanket shelter for ourselves.

Promptly at 5 a. m. the horn blew and with a hastily made toilet the ladies showed themselves true campers. After breakfast we invited them to go bass fishing and their efforts were rewarded with 6 one and 2 pound bass. We were loath to have the ladies leave, and for 2 days we entertained them. Poor Bob Walker had to go back to the city and lamented the fact. Visitors came and inspected our camp daily. During intervals we managed to go swimming and fishing to our heart's content, not forgetting to pan broil our bass. Saturday came altogether too soon, and, our week being up, we pulled up stakes, resolved to come again another year.

Mrs. Suburban—There goes Mrs. Toughman. Is she in mourning for her late husband?

Mrs. Knowit—No; only wearing black for him.—Cincinnati Times-Star.

A HUNT IN THE BIG HOLE.

CLARENCE JAY.

In the fall of 1882 a party of 5—Colwel, Decker, Lockrey, father and I—pulled out of Barratt's and took the hill road around Pointdexter's ranch to Rattlesnake creek. There we turned West and passed Road Agent's rock, the scene of many a hold-up by Plummer, Slade and others in days when that region was an El Dorado. A few miles farther on we came to Bannock City, shrunken to one street and about 60 inhabitants, though once the richest gold camp in Montana. Thousands of acres surrounding it had been torn up and washed in search of gold, and the banks of the creek were so honey-combed with tunnels as to resemble a gigantic hornet's nest.

We drove through the town and camped for dinner on the creek a little way beyond. Then we journeyed on up the valley of the Grasshopper, passing a few stock ranches. Late in the afternoon we ran into a bunch of sage hens, and Decker, father and I piled out, armed for war. We could muster but 3 weapons in the crowd, 2 needle guns and an old 45 repeater. With them we managed to pick up one or 2 birds and waste a lot of ammunition.

At Bald Mountain we crossed the bench land to the divide at Big Hole basin, and, turning from the road to the timber a mile or so back, went into camp under a big pine. Having no tent, we used a wagon sheet to keep off the dew. About bed time we were treated to a concert by a band of coyotes. They made noise enough for a score, but Colwel said there were only 3 or 4.

After breakfast next morning Colwel, father and I struck into the timber, separating as we advanced. I had not gone far and was tiptoeing along with the needle gun at full cock, when a deer broke cover. Just as I fired the animal passed out of sight behind a tree. However, I found its track and a few drops of blood on the pine needles that covered the ground. I followed the trail some distance but finding no evidence that the deer was badly hurt, I turned back toward camp.

Farther on I came to an old fire slash, thickly grown with young pine. In the middle of it I came face to face with a large black bear. It was a case of mutual repulsion; Bruin ran one way and I the other. I lost my hens, tore my clothes and scratched my face and hands, never pausing in my flight until I reached a ledge of rock. On that I perched until I heard several shots near. Presently a deer flashed through the brush and a few min-

utes later Colwel came in sight. He laughed heartily at my forlorn appearance and asked what had happened. I kept the bear story to myself and merely said I was resting on the ledge.

I went with Colwel to help carry in a deer he had killed. It was a big buck mule deer, and the first dead deer I had seen. We slung it on a pole and reached camp with it about nightfall.

The following morning we crawled up the divide toward Big Hole. Reaching Bull creek, we turned to the foothills and crossed a low mountain that juts into the valley. Then came a gradual descent to the hot springs and a jog down the valley until it was time to camp for the night.

We continued our journey and by noon reached Noovis', the only ranch on Big Hole at that time. There we forded the river and turned West, camping on Trail creek.

Heading South we went on to the timber and camped in a small opening. There was a spring on one side and on the other a creek that beaver had dammed, making a small pond. A well beaten game trail ran through the clearing, and all around we could see where bear had been digging skunk cabbage roots. We turned in after supper, leaving the fire burning brightly. About 10 o'clock there was a commotion. The horses, which were tied to the wagon, snorted and plunged furiously. They upset the wagon but did not get away. We all heard 2 bears rush across the creek, and the next morning we found tracks wider than my hand and 14 inches long.

I remained in camp the next day while the others went hunting. About 9 someone began shooting, back in the timber, and kept at it until I counted 11 shots. Pretty soon I heard another shot from a different gun. An hour later Colwel came in and said father had killed a moose. We put the harness on the horses, and, with the whiffle-trees and a rope, went after the moose. We passed Decker sitting on a log, the sickest looking man I ever saw. He had been the first to see the moose and had fired at it as long as he was able to load the gun. Father came up in time to see the animal making off leisurely and Decker standing with mouth open and knees knocking together, both hands full of cartridges and his gun on the ground.

Before we came home I shot an antelope and a mountain sheep. The others were also fortunate, and we pulled out with meat enough to last far into the winter.

A YOUNG PORKER.

Here is a picture of another fish hog. His other name is L. R. Austin, and he lives at Van Wert, O. The picture is labeled "Three Hours' Fishing on Crystal Lake." It should have been tagged "Three Hours' Slaughter." I am informed that Aus-



H. C. AUSTIN, VAN WERT, O.

tin is only 19 years old. I trust that before he is 20 he will know he has disgraced himself in the eyes of all decent men, and that in future he may quit when he gets enough. His number in the fish hog book is 1,007.
—EDITOR.

DUG UP AGAIN.

In Philadelphia, they inquire,
"Who was your sire and his sire's sire?"

In Boston, you must make it plain
You have an intellectual brain.

In New York you must show the 'mount
Of cash upon your bank account.

In Baltimore, you must proclaim
The women queens, in beauty's name.

In Washington, they give you place
According to your rank and grace.

In Denver, they are so polite
That you must either drink or fight.

Down in St. Louis, they exclaim
"Where is it from where you have come!"

In Chicago, when you walk the street,
They always step upon your feet.

In San Francisco, they demand
That, being called, you show your hand.

In Omaha, they merely grin
And murmur, "When did you roll in?"

In Albany, it's "Hello, Will,
What's that you've got, another bill?"

In Brooklyn, you will find a friend
If only you his church attend.

But in Milwaukee, you will hear
"We make dat famous Cherman beer."

In Cincinnati, they all say,
"How long do you expect to stay?"

In New Orleans you can't be tony
Unless you always play a pony.

In Key West, you must smoke cigars
Or line along the hotel bars.

But Yonkers lets you cut no ice,
Unless, by Jove, you've got the price.
—Yonkers Herald.

"Pa, what's a pessimist?"
"A man who always thinks when he gets up in the morning that it's going to be the hottest day of the season."—Chicago Record-Herald.

Bobby—Grandma, do your glasses magnify?

Grandma—Yes, dear.

"Well, when you cut my cake will you please take them off?"—Harper's Bazar.

HOW TO USE A POCKET COMPASS.

W. L. MARBLE.

No doubt most readers of RECREATION know how to use a compass, but probably there are others who do not, and I trust the suggestions I shall offer may be of service to them.

First in importance is the selection of a compass. This does not necessarily mean an expensive one. I once owned one that cost only 30 cents, and that was accurate and reliable for more than 10 years, in nearly constant use.

The needle, or pointer, should have an agate bearing or jewel, firmly set in a brass cap, and should be accurately balanced on a finely tempered and pointed pivot. The needle should be thoroughly magnetized and should vibrate sensitively at the least change in position of the compass box. A needle that vibrates rapidly and easily always points right when it settles; whereas, one that vibrates slowly and settles quickly is liable to be off a few degrees when it settles and consequently to be inaccurate. Compasses vary so much in this respect that you may have to test a number before finding one that is perfect in every way. You want one that will tell the truth every time. Then you should believe it and trust it even if it does seem to point the wrong way. Don't argue with your compass. It is always a waste of time, for the compass is bound to win out.

It is always best to select a compass with an arrow shaped needle. Some are made with both ends of the needle alike, except that the North end is colored blue and the South end is polished. Some people have been known to forget which end was North.

The size of the compass does not cut much of a figure. One anywhere from $\frac{3}{4}$ to $1\frac{1}{2}$ inches in diameter is large enough for a sportsman's use. Timber cruisers, who have to run accurate parallel lines, usually carry compasses with $2\frac{1}{2}$ to 3 inch needles with raised and graduated dial and with folding sights.

Some people prefer a stop on a pocket compass. This is a little lever which presses the needle against the crystal when the cover is on. I consider the stop not only unnecessary, but detrimental, as it allows particles of dust to get inside the box, which eventually work their way into the pivot cavity of the needle mounting, and interfere with the free working of the needle. Most compasses are made so that they can not be taken apart for adjustment without injuring the crystal, or the flange that holds it in place. This is a bad feature and should be avoided in the selection of a

compass. It often happens that the extreme point of the post becomes dulled, or broken, or slightly bent over. If you can readily take the box apart the point may be sharpened with a fine whetstone and made as good as new. This is important when you are not where you can step into a store and buy a new compass. If you are going into the woods alone and where you must depend on the compass, always take along an extra one, or still better, 2 extra ones, so that if one should become damaged your business or pleasure may not be interfered with.

The compass box should be waterproof, as the least moisture under the glass will cause the needle to stick to the crystal, and until this has been thoroughly dried out your compass is worse than none. I had to stop once in a driving snow storm, late in the afternoon, miles from camp, build a fire and dry out all 3 of my compasses, which had collected moisture under the glass to the extent of being entirely useless. They were not waterproof.

If you are going hunting in unfamiliar territory, where you are to depend on your compass to get you out, a map showing the topography of the country is of great benefit and may usually be secured at the State land office, the county seat or at the United States land office. These maps are compiled from the field notes of the surveyors and indicate the location of streams, lakes, roads, mountain ranges, hills, swamps, etc. Locate your camp on the map. You will usually camp on a stream, lake or road.

If the general course of the road or stream is East and West and you are to hunt North, you will only have to travel South to get back to your base line or camp. If your course varies to the East of North you should make the same distance West of South to get back to your starting point.

Consult your compass often. Otherwise you may swing so far from your course in going only a short distance that you will be inclined to doubt the accuracy of the instrument. If you get bewildered and forget which way to go, always remember that a straight course in any direction will take you somewhere. A lost man once came to my camp who had walked continuously 6 days and nights, and was only about 6 miles from his starting point. Five hours of travel in any one direction would have taken him out of the woods and saved him the loss of both feet by freezing.

If you wish to lay a fairly accurate course and have both hands at liberty hold your

compass in both hands, at half arm's length from the body, with the elbows resting against your sides and so as to bring the compass in direct line with center of your body. To settle the needle quickly tip the compass until the end of the needle touches the glass thus checking the vibration. Repeat this quickly 2 or 3 times as the needle is passing the center of the arc it is making. Then carefully level the box and as soon as the needle stops vibrating take a sight on some object in exact alignment with your course and as far ahead as you can see. Walk to it and repeat the operation.

A little practice will enable you to run an accurate line.

Your confidence in the utility of the compass will increase rapidly as you become more familiar with it. It adds greatly to the pleasure and success of a trip in the woods to feel that you are not altogether dependent on a more experienced fellow sportsman, or a guide, to enable you to get back to camp; and it is a source of great satisfaction to know that you can strike out and explore new territory alone and find your way back to camp with the aid of the most absolutely reliable guide you could possibly have, a pocket compass.

MY FIRST DAY'S WORK.

ARTHUR S. PHELPS.

The reddening dawn in the twilight gray,
Before the rising sun
Has kindled his fires on whirling tires,
Behold my day's begun!

A tiring spin on a spinning tire.
A league between the pines,
The foot hill's slope is swallowed up
Ere Winter's sunlight shines.

The ice king's sceptre has never controlled
These hills of the Sunset State;
The climate how rare! How balmy the air
That streams through the Golden Gate!

Robbed of my coat by the overbold sun,
I am armed with mattock and hoe,
My thousands to slay, that weary day,
Where the weeds their faces show.

My first day's work! How slowly it dragged
Its infinite length along!
When the motor at 10 whistled loud in the
glen,
The conductor's watch surely was
wrong!

My curses on Adam, who left us these
weeds
To hoe by the sweat of our brow!
This mattock is dull, my shoes are half full,
It must be noon-time now!

At length up through the hills came a note,
Never so sweet before;
At the whistle from town, the tools are
laid down,
And I lurch on the porch by the door.

My first day's work! Words fail to describe
The taste of that cold meat and pie!
The hunger of health, forbidden to wealth,
Is the workingman's proud legacy.

In the afternoon, on the sunny slope,
Through the orchard's leafless trees
Blew sweet below, from th' eternal snow,
Sierra's cooling breeze.

Before the eyes, a wondrous view,
The fruitful valley lies;
Earth's workday vision, fields Elysian,
Beyond toil, Paradise.

My first day's work! A drudge's day,
Spent grubbing in the soil?
In hand-wrought earth rich fruits have
birth;
Life's problem's saved by toil!

FROM THE GAME FIELDS.

The man who quits when he gets enough, with plenty of game still in sight, is a real sportsman.

HALCYON DAYS IN WEST TEXAS.

In January, 1892, 2 friends and I made a hunting trip to Gomez peak, in the Davis mountains, West Texas. We carried rifles for deer and bear, and shot guns for quails. In the way of grub we had flour, bacon, *frijoles*, coffee, sugar, dried apples, *chile*, baking powder, salt and rice.

The *frijoles*, or red beans, we cooked *à la Mexicano*, by boiling and frying with *chile*. They are nourishing and a good standby.

At the section house whence we were to start to the peak, we piled off the train, unrolled our blankets and slept till morning. Then we got a Mr. Smith to haul us and our outfit to his ranch, where we passed the night. The next day we got another man to take us to the foothills. On our way up there we shot a lot of quails.

We camped near a cool spring of water, put up our 7 x 7 tent, cooked our birds and ate supper.

The next morning we started out to look for deer. We soon found plenty of signs and I saw a deer. I told S. to shoot, but he said he could not see it; so I took a crack at it and missed. E. saw a buck but failed to get a shot.

The next morning we went out again and jumped a fat doe. I got in the first shot and she stopped, hit in the loin. E. turned loose with the cannon and we had venison.

A few days later I broke the foreleg of a deer near the shoulder and I failed to get it, though I traced it a long way. After losing the trail of it I started for camp, not knowing exactly where I was. As I came down a narrow canyon I heard stones rattle, and on looking up saw a big buck trotting slowly down the canyon. I took a shot as he ran, and missed. He ran up on a little ridge where he was sharply outlined against the sky. As I had but one rifle cartridge left, I dropped on one knee and drew a bead on his shoulder. At the crack of the rifle he gave one jump, dropped his flag and came rolling down, shot through the heart.

It was nearly sunset, so I hurriedly dressed him, saving the head and horns to be mounted. I doped the entrails and blood with poison, took one ham and, hanging the balance of the carcass in a tree, started again for camp.

I followed on down the canyon and soon struck the main one, which ran just back of camp. As I neared home I heard the pattering of feet, and on looking just across the ravine saw 2 yearling deer. They stopped and looked at me in surprise, and

apparently could not make out how the buck's head happened to be on my back. I drew my 6 shooter, held it with both hands, drew a bead on one of the deer and let go. I heard the ball strike the rocks with an angry pi—ng—and the deer scampered away. I was not sorry, for we had meat enough.

The next day I met a cowboy who said he had shot a young deer that morning and that there were 2 together.

When I got to camp I found E. had killed a deer, making one for each of us, which was enough.

We went out the next morning, brought in the rest of my buck, and found near the poisoned entrails a dead civet cat, which looked much like a domestic cat. Its tail was ringed like that of a coon, and it had a peculiar odor. We saw panther and bear tracks, but failed to meet either, though we searched diligently for Ephraim.

We saw plenty of Messina quails, handsome little creatures, the head being marked something like that of the male Bob White. They made a chirping noise when we came near them and would rise in a bunch, take their flight together and alight the same way. We did not kill any of them, as they were near the deer feeding grounds and we did not carry our shot guns to that section.

We remained in camp 2 weeks and I never enjoyed a hunt more in my life.

Can anyone tell me how a deer gets along without a gall? And of what use are the 2 little openings at the inner corner of each eye?

What is the best way to take the grease out of bear skins, or those of other animals?

David F. Crowell, New Haven, Conn.

ANSWER.

Hornaday's Taxidermy, and his American Natural History, published by Chas. Scribner's Sons, New York, will tell you all these and many other useful things.—
EDITOR.

A HELLROARING BEAR.

October 11th, 1899, while hunting alone on a mountain side near the head waters of Hellroaring creek, Montana, and after tracking for several hours what I supposed was a black bear, I took a chance shot at a moving object about 60 feet distant and probably 20 feet above me, nearly concealed by snow-laden scrub pines. At the crack of the rifle the bear made a spring over and through the small trees directly toward me. That spring measured 7 long paces.

Before the bear could make another spring I planted a ball in the middle of his neck, knocking him flat to the ground. He instantly raised on his front legs, his hind legs not appearing able to hold up his body. His head was much nearer the ground than before. He made another lunge directly toward me, covering about his length. All the work of lifting his body and carrying it forward seemed done by his front legs alone. He landed the second time in a sitting position. That instant he received another ball about an inch back of the first, which flattened him out, but he as quickly regained his front feet and duplicated the last jump, only to receive a third ball within an inch of the second, with a result of again bringing him to the ground. Again he quickly gathered himself, using his fore legs only, as before, and made a final short lunge. At the same time he received a fourth bullet in his neck. His last charge brought him up against a scrub pine 3 1-2 inches in diameter, which he seized near the ground and tore up by the roots. He tore up other small shrubs, then gradually crawled to the left about his length and up an embankment some 4 feet high, where he died.

After skinning the beast with hatchet and knife, I carefully examined the wounds and found that the 4 bullets had entered his neck about 8 inches back of his ears and directly in line with the center of his spine; had torn through it and entered his lungs, tearing them into small fragments. His heart and liver were not injured. About 5 inches of his neck bone was broken into fragments. The marrow and spinal cord were undoubtedly severed by the first bullet. All the blood in his body seemed to have gathered in his lungs. None of these bullets could have missed the spine, and I am positive the second bullet was the one that did the greatest damage to his spine. The first shot, which merely crippled him, struck him through the fleshy part of a hind leg, and did no injury. At each shot the animal gave an ugly roar. I used smokeless powder, 30-40 soft-nosed bullets. None of these bullets went farther than the lungs, and they seemed to convert the tissue into a projectile, for tissue, cords, nerves and all had taken a rotary motion. The wound in the animal's neck was so large I had no trouble in thrusting my arm through it into his lungs before using the hatchet or knife.

My hunting partner on that trip was C. F. Loudon, of Cincinnati. Our guides pronounce the beast the finest specimen of grizzly bear he has seen in his 34 years in the mountains. The taxidermist who mounted the skin for a rug, says it is the finest specimen he has ever seen and that I will never get another like it.

I am often asked why I did not run or

climb a tree when this bear charged me. I can only say there were no trees near and time was too limited for thought.

Geo. A. West, Helena, Mont.

HOW WE GOT HIM.

Early in October, a jolly crowd rolled out of the village of Drain, Douglas county, Oregon, for a trip to Bradd's creek and a go at the deer. The canyons and ridges around Bradd's creek are famous hunting grounds. Our party was under the direction of Capt. John Woods, a veteran hunter from old Virginia and his right bower, Joe Lyons. Pete Mattoon was our driver and a better one never pulled a line. We were joined at Elkton by Pat Beckley, as rollicking a lad as ever lived. When he and Pete started down the line there was all kinds of fun going.

One bright, warm afternoon Pete took the hounds, old Pedro and Jack, up on the burn above camp to see, as he expressed it, if he could "raise suthin," while Joe, Pat and I went down on the river to await events. My position was under a clump of willows about 200 yards below the mouth of the creek, Pat hid under a bunch of river maples 300 yards above me, and Joe, still higher, was on a point of rock near the lower end of the big slide. We had watched and waited nearly an hour when I fell into a doze. How long I enjoyed the nap I cannot say, but my slumber was suddenly broken by the rush of a bouncing old buck. He came smashing through the brush directly above me. I sprang to my feet and threw my 30-30 to my face just in time to see the sunlight glimmer on his white flag as he disappeared in the thimble-berry bushes which skirted the bank.

Ringing down the ridge and echoing through the canyons came the cries of old Pedro and Jack. They came down the trail to where the deer turned, and were soon hot after him again. They took him up the ridge above camp, crossed the canyon, up on the divide and down the long ridge straight for the slide. Joe evidently heard them coming, for we could see him shifting his position and getting ready for business.

Soon the buck burst from cover and came tearing down the slide with Jack not 50 feet behind him. Pedro, game to the last, was making music some 500 yards behind them, up on the ridge. With a mighty bound the old forked horn jumped into the water with Jack a close second, and then began the prettiest race I ever saw. The buck was the fastest, however, and was soon wading out on the bar across the river.

As I was thinking we should lose him after all, Joe cut loose with his 40-82. His first shot hit the bank above the deer and started him down the bar. The old rifle barked again and the buck went on his

knees. Pat and I yelled a hole in the air, but the echo had scarcely died away when Jack and the deer got into rough and tumble and were soon coming like the wind straight down the bar, nearly opposite where Joe was standing. Once more Joe's gun belched forth and the forked horn went all heels up, that time for good.

We got a long rope from the camp and after an hour's hard work had him hung up. The first shot had struck him in the fleshy part of the neck; the one that did the business landed just behind the shoulders. He was a 4 point buck and the fat on his back was as thick as my hand.

F. C. Godley, Drain, Ore.

FOUR SHOTS, FOUR BEARS.

EDWARD BARNEY.

I am a farmer living near Hubbard's lake in Alpena county, Michigan. I set out May 19th to go to Alpena on business and when 4 miles from home was startled by a noise in the bushes by the roadside, which I supposed might be caused by deer. Although unarmed, I stopped. Presently I saw 4 bears, a mother and 3 cubs, not more than 10 feet distant. The mother instantly rose to her hind feet, prepared for battle, growling ferociously to frighten me away. The cubs scampered up a large hemlock.

I backed off about 6 rods. Then the mother started away, calling her children to follow. At this I advanced to the tree. She charged me and I retreated. So, between advance and retreat in alternation, we kept busy an hour, both never being in the advancing mood at the same moment.

At last I heard a team passing on a road 80 rods distant, and ran rapidly to intercept it. I succeeded in doing so, sent for a rifle and then hurried back to the tree. Much to my gratification I was in time. The cubs were still among the branches. Many times the old bear tried to drive me away, but I returned to sentry duty as soon as she retired to resume her calling tactics.

When 2 hours of this charge and retreat had passed, Alf Robbins came with a rifle and 3 companions. They scared the mother away. Alf and I shot one of the cubs, which cried out, bringing the mother back instantly to its relief. Alf's companions climbed trees at this juncture. The mother climbed into the tree with her cubs. We tried to get a shot at her but failed, and she presently came down and went away. We shot another cub and she came back, but again retired unhurt.

It was then too dark to see to shoot the last cub, so we built a fire at the root of the tree and Alf and I stayed there all night; the others came down from their trees and

went home. We kept plunging around, replenishing the fire, and were from time to time visited by the unhappy mother, but not attacked. We intended to keep watch all night, but at last we lay down, just to stretch our limbs and rest, and, as might have been foreseen, both fell fast asleep. The fire was almost dead when Alf, startled by a crash in the brush near, sprang to his feet and yelled to me:

"The fire is dying and the bear is here! Start a blaze quick!"

I did as directed, and as the flames sprang up the mother bear fled once more. At daybreak we killed the remaining cub. In an instant the mother was upon us, and, getting a chance, we finished her, too.

ON A CALIFORNIA SLIDE.

As the deer season opened July 15th, our company of 5, all expert riflemen, started up the San Gabriel canyon early in the morning of July 14th. When about half way up the canyon we discovered that the mountains were on fire not far ahead. Soon we met a Government ranger from Rincon who furnished us tools and took us to the top of the mountain where we went to work to help put out the fire. It covered about 100 acres, but in 4 hours we succeeded in checking the flames. After there was no more danger of the fire's breaking out again we started on, reaching our camp-ground late in the evening.

The next morning we saw plenty of signs of deer. I became separated from my friends and forced to cross a dangerous slide about 200 feet high. Being a tender-foot, I was unable to get either way. I struggled hard to get a foothold and tried to brace myself with my gun. For a while it seemed as if I would surely be carried down over the precipice below. I was almost ready to drop my gun and canteen when I saw, not far ahead, a rock embedded in the gravel, so I made a desperate effort to reach it, in the hope that should it give way it would leave a cavity where I could brace myself long enough to reconnoiter. It proved to be firm, so I remained braced against it until I could make a lunge for another rock and some brush a few feet farther on. My legs were trembling and so fatigued they would scarcely hold my weight, when my friends came back to hunt for me. They helped me out and we started to reach the river. We scrambled down a steep precipice and through thick brush, sometimes crawling over and sometimes creeping under. It was not long until we came to a little canyon, which we followed until we reached the falls. At first it seemed dangerous to attempt to make the descent, but it was too late to go back and we finally succeeded in climbing down by

the aid of a tree. Our way back to camp was then comparatively easy.

Soon after we reached camp, Neet and Roll came in, sore in body and heart. After leaving us they had started a large buck and given him several bullets. He dropped and rolled into a clump of brush. It took them some time to reach the place where he fell, and the deer could not be found. After hunting the ground far and near they were obliged to give up.

L. O. Newcomer, Glendora, California.

MUSKRAT TRAPPING.

Notwithstanding the fact that trapping is considered a cruel sport and all trappers in Cooper's *Leatherstocking Tales* are held in contempt, there is a branch of the craft which probably affords more enjoyment to boys who live in the country than any other amusement they could choose, and at the same time it brings in a good supply of pocket money. This is muskrat trapping, which is the least cruel sport of the kind, as in 9 cases out of 10 the victim is drowned soon after being caught, by jumping into the deep water and being pulled under by the weight of the trap.

The outfit should consist of 10 to 15 single spring steel traps, a good jackknife, a pair of rubber boots, and, if the trapper be of sufficient years, a shot gun; for although the little denizens of the marshes and streams are generally out during the night, they are also often seen in the day time. If one can not have the use of a boat, one may be successful by following the small brooks and when a narrow place is found building a dam with sticks or rocks, leaving a space in the middle at the surface of the water just wide enough for the muskrat to go through, and step in the trap, which should be about half an inch below the surface.

It often happens that nests on the outskirts of ponds can be reached by land, and as the ponds are usually surrounded by paths, the occupants can easily be caught.

The most successful method, however, is using a boat in some small fresh water pond and its inlets, where the so-called "haul-ups" can be reached, as well as the greater number of the nests, which are often surrounded entirely by water. A haul-up is simply, as the name implies, a tangle of weeds and grasses hauled together and matted down, so that the rat can crawl up on it. A haul-up, therefore, makes an excellent place to put a trap, while good luck nearly always results from setting on a good new nest.

Many use bait of some sort, either apple or any garden vegetable, putting it on the end of a stick over the trencher of the trap.

H. L. Bailey, Byfield, Mass.

WHAT BECAME OF THE FOX?

The following incident of a fox hunt was told me by an old friend, and owing to its myterious ending, may be of interest to many, especially those acquainted with the tricks and turns of Reynard.

"While spending the Christmas holidays, in 187—, with an uncle, who lived on the old homestead, some miles from New Haven, Conn., my attention was attracted one morning by the baying of 3 hounds, on the trail of a fox. Knowing the lay of the country and the course usually taken by foxes in that vicinity, I called the hired man, and securing our guns, we hurried to a neighboring hill, taking positions behind an old stone fence. We were not kept long in suspense, for the fox came over the fence about 30 yards from us.

"I gave him a charge of B B's which dropped him in his tracks, apparently dead. I hurried toward him, at the same time trying to remove the empty shell which had stuck in the chamber of the gun.

"To my surprise, before I reached the fox or could reload, he got up and lit out as though nothing had happened. The fact that I was directly between the fox and Sam prevented him from getting a shot. In the meantime, the dogs came up, and seeing strangers, turned back. We followed the track of the fox and every jump was plainly marked by a small stream of blood on the snow, from either side.

"After some 300 yards the bleeding stopped, but the trail still led us into the woods and to a small opening, in the middle of which it abruptly ended. An hour's careful search, beginning in a small circle, and continued in larger ones, failed to bring to light the faintest sign of fox or track.

"While we were not called liars outright, our story caused no end of discussion through those winter evenings around the big stove in the village store, and I have never been able to explain satisfactorily to myself or others what became of the fox. Can anyone explain the mystery?"

S. W. Stanley, Weiner, Ark.

Possibly the holes made by the shot released his wings and he flew away.—EDITOR.

NEW BRUNSWICK GUIDES' ASSOCIATION.

The annual meeting of the New Brunswick Guides' Association was held at Fredricton, March 2d. The retiring president, George E. Armstrong, occupied the chair. The attendance was large and the proceedings most harmonious. The president reported that about 500 non-resident sportsmen had visited the Province last season, and few were unsuccessful in securing game. There were also an unusually large number of canoeing and fishing parties, and they had invariably returned home well

pleased. The election of officers for the ensuing year resulted as follows: Honorary president, L. B. Knight, chief game commissioner of New Brunswick; president, Arthur Pringle, Stanley; vice-president, W. Harry Allen, Penniac; secretary-treasurer, Robert P. Allen, Fredericton; executive committee, Sydney Thomas, Charles Cremin, G. E. Armstrong, with the president and vice-president; committee on membership, Adam Moore, Thomas Pringle and Fred H. Reid.

A resolution was passed reducing the membership fee from \$5 to \$2, and it was decided to admit honorary members on the same terms as ordinary members. A number of applications for membership were received and favorably reported on by the membership committee. It is hoped to have every competent guide in the Province enrolled in the association within a short time.

There was some discussion over the game law, and the members agreed that it would be inadvisable to recommend any changes this year. The hope was expressed, however, that the government would adopt more stringent measures to prevent the slaughter of big game during the winter. The members of the association are nearly all readers of RECREATION, and took occasion before separating to express their approval of the trouncing which that excellent publication lately administered to an alleged sportsman from New York, named Jackson, for crooked work on the Nepisquit river, in this Province.

IN A TEXAS CANEBRAKE.

A ride of 20 miles took 5 sportsmen to the Big Thicket, an immense swamp in Jasper county, Texas, where we were to hunt. Canebrakes miles long and wide shelter deer, bear, bob cats, foxes and many other animals.

The manner of hunting deer is the same all through the Southern States; they are driven with hounds to stands where the hunters lie concealed.

Three of the party used shot guns, another used a 38-55 rifle and I a 30-30.

Break of day found us on our stands while our guide uncoupled 4 hounds in the thicket facing us. In less than 25 minutes the dogs found game in young cane at the edge of a creek. Above the deep throated baying of my Cuban bloodhound I could hear the crashing and cracking of brush caused by the stampede of deer. My position covered an open glade, near the center of which I lay in wait by my saddled horse. Suddenly out of the swamp dashed a buck. My first shot only served to accelerate his speed. A second caused him to stagger and a third killed him instantly.

When dressing him I found that the second bullet had struck the right foreleg

just below the brisket, completely shattering flesh and bone. My last shot struck fair on the right hind quarter, the mushroomed bullet ranging upward and perforating the liver and heart.

Later in the day I missed a doe with 2 shots. In the evening I saw a spike buck drinking at a water hole. At 15 yards, my first bullet struck him in the left shoulder and, mushrooming, passed out on the opposite side.

The soft nosed ammunition has no equal for smashing power. When hunting turkeys and wild geese I use the full mantled bullet with great success.

La Paloma, Beaumont, Tex.

IS DEER LIVER GOOD TO EAT?

I see in February RECREATION, page 132, that E. B. Brigham, M.D., of Indianapolis, Ind., credits me with writing an amusing article entitled "Give Them Marlins," and asks, "Did he ever eat a deer's liver and how many of your readers ever did?"

Possibly he has heard someone talk who killed a buck late in the fall. That is their running time, when the neck is swollen, and the liver would be worthless, being strong, as also the meat. This would also be true were the deer diseased, as is true in the hog family; but nearly all hog livers are diseased, while disease is exceedingly rare in venison liver.

Any old time Western hunter will corroborate my statement that a deer, killed in season and in good healthy condition, has a liver that, when properly cooked, will make every man around the camp fire smile, be he Fish Commissioner or an M.D.

When the hunter, trapper, prospector or cowboy kills a deer he hangs the carcass high and makes tracks for camp, his gun on his shoulder and the liver securely tied on his saddle or in an old red handkerchief. Ever notice the smile he wears on reaching camp with this trophy? Only one smile beats it, and that is the one a man wears when getting into camp with about 20 rainbow trout, 8 or 9 inches in length.

Yes, sir, I have eaten venison, or deer liver many, many times. It is tender, juicy, decidedly fine in flavor. It is superior to any veal liver.

What will you say, Brother Brigham, when I invite you to produce a deer's liver and show the gall?

I hope to go hunting next fall, and if you will pay express charges I will send you the liver from a 2-year-old buck and let you tell RECREATION readers about it. Couldn't get a .303 Savage and join me, could you?

Jean Allison, Jerome, Ariz.

WARNING TO FISH AND GAME HOGS.

Mr. E. W. Wild, editor of the Erie, Pa., Dispatch, endorses RECREATION'S crusade

against game and fish hogs. Here is what Mr. Wild says editorially:

Fish and game hogs everywhere will do well to take warning from the fate of Harry Winters, of Helena, Mont., who recently was fined \$400 by Judge Henry C. Smith, in the district court, for dynamiting fish. Judge Smith said: "A man who will dynamite fish must be absolutely devoid of sportsmanlike qualities. People who dynamite fish have been characterized in journals relating to outdoor sports as hogs; and that is an appropriate designation. One man is limited by law to catching fish with a hook and line; another man comes along, clandestinely drops a stick of dynamite into a hole and kills not only the large fishes that are good to eat but every fish that is in the hole, and the fish food besides. Not only that, but the fish are mutilated and some of them rendered unfit for food. I am surprised that a man of your intelligence and standing in this community should do such a thing. You knew it was against the law; it is the worst possible infringement of the game law, in my judgment. There is no excuse for it whatever."

The foregoing is a splendid endorsement of the relentless campaign being waged against fish and game law violators and hogs by RECREATION, the magazine edited by G. O. Shields, President of the League of American Sportsmen, and is evidence that the real sportsmen of the country recognize the necessity for the strictest possible enforcement of all written laws and the enactment of improved legislation, if the preservation of fish and of the game, song and insectivorous birds is to be effective. Furthermore, there is an increasing sentiment in favor of the observance of certain unwritten laws, chief of which are those reasonably limiting the number of fish caught or game birds or animals killed, irrespective of greater privileges permitted by statute. The day has passed when a man may capture more fish or slay more game than meets the consensus approval of true sportsmen, without danger of being branded by Mr. Shields as one of the hogs, with a special number attached to his name and perhaps his likeness published. The pen now contains a full one thousand men, who are thus held up to the ridicule and contempt of the many thousands of the magazine's readers.

43 SNIPE IN 3 SHOTS.

For a week past thousands of frost, or gray-back, snipe have been arriving on the beaches of Cape May county. The birds are feeding in flocks of a score to several hundred, and they are tamer now than they will be later in the month.

The birds are as fat as butter. They fly close together and the sportsman who uses shells loaded with $3\frac{1}{2}$ drams of smokeless powder and $1\frac{1}{4}$ ounces of No. 7 shot will find it easy to bring down 6 to 10 birds at a shot.

Former Councilman Crawford Buck, of Sea Isle City, did some good shooting Tuesday morning. He went up the beach 2 miles from town and killed 43 snipe in 3 shots.—New Jersey paper.

Your letter of inquiry received. The truth of the matter is as follows: I came up to a flock of what we call frost snipe, and with the first 2 barrels picked up 17. With the second 2, I secured 20; so with 4 shells I bagged 37 birds.

Crawford Buck, Sea Isle City, N. J.

You are entitled to a place in the game hog register if ever a man was, and your name goes down opposite the number 1,008.

—EDITOR.

OREGON WARDENS DO GOOD WORK.

A. W. Nye, a deputy game warden of Eastern Oregon, recently captured 17 of the notorious game butchers who for several years have been killing deer in that State for the market. In many cases these men have taken only the hides of the animals they have slain and have left the carcasses to rot. Mr. Nye succeeded in convicting 16 of the men, who were fined \$25 each. This is a paltry sum, and an inadequate punishment when the enormity of the offense is considered; but the lesson will no doubt prove valuable to these men and to their neighbors.

Mr. L. S. Fritz, of The Dalles, Ore., who is a member of the L. A. S., captured another man and convicted him of having killed an elk in close season.

Hon. J. W. Baker, the Oregon State Game Warden, has determined to break up the gang of market hunters who have been slaughtering deer and elk in Eastern Oregon, and every good sportsman in the land will wish him Godspeed.—EDITOR.

ANOTHER EDITOR ON MY SIDE.

In a recent article entitled "Down With the Game Hog," the editor of the Canyon City, Ore., Eagle, says:

"A law against the use of the deadly and destructive pump gun is necessary for the game interests of the State. There is no excuse for the use of a weapon of this character. It results in wanton destruction of game and is of no possible advantage to anyone. It should be borne in mind that adherence to wisely enacted law for the protection of game is essential, if in the course of a few years there is to be any place in the State where the sportsman can find recreation. It should not be the aim of the law to interfere with the hunter whose methods will not work the extermination of game, but for hoggishness there should be no toleration."

GAME NOTE.

Hon. H. S. Huson, Probate Judge, Grand Rapids, Minn., whom I have before had occasion to commend for his sturdy and fearless enforcement of the game laws, writes me that one Christ Biggerstoff was recently brought before him charged with having the meat and hide of a deer in his possession in close season. The judge fined the defendant \$55.90, and being unable to draw a check for the amount the culprit is serving a 60 days' term in jail. Biggerstoff is an old market hunter and the wardens have been after him for several months. He will now have ample time in which to think it over and I trust he may make up his mind to adopt some legitimate means of making a living.—EDITOR.

FISH AND FISHING.

ALMANAC FOR SALT WATER FISHERMEN.

The following will be found accurate and valuable for the vicinity of New York City:

Kingfish—Barb, Sea-Mink, Whiting. June to September. Haunts: The surf and deep channels of strong tide streams. Baits: Blood worms, shedder crabs and beach crustaceans. Time and tide: Flood, early morning.

Plaice—Fluke, Turbot, Flounder. May 15 to November 30. Haunts: The surf, mouth of tidal streams. Baits: Shedder crabs, killi-fish, sand laut. Time and tide: Ebb, daytime exclusively.

Spanish mackerel—Haunts: The open sea, July to September. Baits: Menhaden, trolling—metal and cedar squids.

Striped Bass—Rock Fish, Green Head. April to November. Haunts: The surf, bays, estuaries and tidal streams. Baits: Blood worms, shedder crabs, Calico crabs, small eels, menhaden. Time and tide. Night, half flood to flood, to half ebb.

The Drums, Red and Black. June to November. Haunts: The surf and mouths of large bays. Bait: Skinner crab. Time and tide: Day, flood.

Blackfish—Tautog, April to November. Haunts: Surf, vicinity of piling and old wrecks in bays. Baits: Sand worm, blood worm, shedder crabs, clams. Time and tide: Daytime, flood.

Lafayette—Spot, Goody, Cape May Goody. August to October. Haunts: Channels of tidal streams. Baits: Shedder crabs, sand worms, clams. Time and Tide: Day and night flood.

Croker—July to October. Haunts: Deep channels of bays. Baits: Shedder crabs, mussels. Time and tide: Day, flood.

Snapper—Young of Blue Fish. August to November. Haunts: Rivers and all tide ways. Baits: Spearing and menhaden; trolling pearl squid. Time and tide: Day, all tides.

Sheepshead—June to October. Haunts: Surf and bays, vicinity of old wrecks. Baits: Clams, mussels, shedder crabs. Time and tide: Day, flood only.

New England Whiting—Winter Weak-fish, Frost-fish. November to May. Haunts: The surf. Baits: Sand laut, spearing. Time and tide: Night, flood.

Hake—Ling. October to June. Haunts: Open sea surf, large bays. Baits: Clams, mussels, fish. Time and tide: Day and night, flood.

Weak-fish—Squeteague, Squit. June to October. Haunts: Surf, all tideways. Baits: Shedder crabs, surf mullet, menhaden, ledge mussels, sand laut, shrimp. Time and tide: Day and night, flood preferred.

Blue Fish—Horse Mackerel. June to November 1st. Haunts: Surf, open sea and large bays. Baits: Menhaden, surf mullet and trolling squid. Time and tide: Daytime; not affected by tides.

A DAY WITH THE BLUE FISHERMEN.

CHESAPEAKE.

How few persons who enjoy eating the delicious bluefish know how they are caught by the market fishermen! For the benefit of those who do not I will tell of a day's fishing I had in Chesapeake bay early in September last.

The fishermen go out for business and their boats are built to accommodate 2 men. If a third man goes along, a city dude, without experience in such a boat, he is an incubus; an undesirable and unwelcome piece of ballast. I know several of the fishermen, and as a boat has been one of

my hobbies for years an invitation was extended to me. I accepted eagerly and as we left the beach in our skiff another fisherman was offered \$5 by a hotel boarder to take him out; but the offer was refused.

Our craft was the ideal round bottom sea skiff, fitted with a light sail which could be quickly furled on the mast. The oars were laid across the bow of the boat when fishing, so as to be out of the way. You want a free hand and a clear field when the business begins.

After an hour's sail we reached the fishing grounds, where a fleet of probably 40 boats were already at work. Running through and beyond them we dropped anchor on the outer edge of the fleet, where our skipper thought the tide would be more favorable for good fishing. The sail was taken in and across the boat was laid a sausage grinder with which to grind our 2½ bushels of alewives, which we had taken in before starting.

One man of our crew sat by the grinder and ground out bait as fine as sausage meat. This was thrown over the side a handful at a time, and floated away with the tide, to attract the bluefish. The man who grinds also keeps the fisherman supplied with bait for his hook by cutting from the back of the alewives 2 baits, each about 2 inches long.

Presently our lines went over, being thrown in the wash bait and allowed to drift with it on the tide. In a few minutes after our wash bait had begun to go over we had a school of fish after it and the fun, or rather work, commenced.

Catching bluefish with a troll line, from a yacht, is fun; but pulling them into a skiff with a short line, 16 to 20 feet long, is the greatest sport I ever experienced. One of the necessities in a bluefish skiff is called a bootjack. It is a board shaped like that old fashioned article, and stands upright in the boat, close to the fisherman. Bent across the jaws is a heavy iron wire, nearly as large in diameter as a lead pencil. As the fish is pulled into the boat he is swung over the bootjack and the hook is caught under the wire. Then with a downward turn of your hand holding the line, the point of the hook is brought down around the wire, when the fish slips off and falls into the after end of the boat.

The barbs are always broken off the hooks by the fishermen, to allow of unhooking the fish quickly.

We fished about 3 hours and were never under the necessity of putting our hands on the fish to take them from the hook. Our fish varied in weight from 1 to 3 pounds.

At one time they came so close we could see them take the bait, and it was pull in, unhook, bait and throw out. Often before the bait had gone under the surface of the water the line would whiz out with another fish on the hook.

We all wore finger stalls of wool or canvas on our forefingers, for without this protection the skin would soon be worn off.

The wash bait had to be kept going over the side by handfuls, and if the grinder had stopped 5 minutes the fish would have left us.

When our last handful of bait washed away with the tide we pulled in our lines and made ready to get our fish to the packing house. The skipper estimated that we had 600 pounds in the boat, a profitable day's work for him and his mate.

I took 9 fish home with me and they made me a good load.

Bluefishing has become an important industry on lower Chesapeake bay. Up to recent years the natives knew nothing of it but the Yankee fishermen began following the fish down the coast and fishing from their smacks in the bay. Now each summer sees an increased number of native fishermen employed. The fish do not usually stay long in one place but are continually moving.

A few years ago I spent an hour in the same locality early in the season. A squall chased us home before our fishing was done, but in that one hour 3 of us caught 64 bluefish, ranging in weight from 0 to 12 pounds each. After pulling in 18 of them I began to have that tired feeling the doctors talk about.

A POUND TROUT.

F. M. LEETE.

Three long months I had been shut in with a severe attack of rheumatism, and it was the first of May before I could hobble around the yard. During the first part of my confinement every motion added to my misery, but when the pain was gone I longed to get out, to go somewhere far from the sickroom. As spring advanced, and the weather improved I grew more uneasy and the first warm days nearly drove me wild. The coming of robins and blackbirds, too, told of approaching summer, and still I was a cripple.

A wet, cold spring we had, and for days the brook back of the house was a raging torrent, while the meadows looked like a lake. Our house is in a fertile valley between ranges of hills, and back of the house some 50 rods is the brook. This little stream, after running miles in and through woods and meadows, widens as it nears the sea, into a navigable river. All my life has been spent on this stream, and each year I have fished the length of it. Every bend

and rock, every tree and bush, is as familiar to me as my kitchen garden. It was as natural for me to fish as it was to eat. My father was an angler, and well I remember the baskets of trout he used to bring home. My grandfather, too, had a love for the sport, and fished as long as he was able to tramp the brook, and my son has inherited the family weakness.

One morning along in May, I hobbled out to the barn, and sat in the South door, completely disgusted with everything and everybody. The weather was perfect, but my bodily ills kept me from enjoying it. While I sat in the doorway moodily gazing at the sunny landscape, 2 neighbors came down the road, Deacon Brown and Henry Smith, and seeing me, came in to chat. After the usual commonplaces the good old Deacon, knowing my weakness, said:

"We saw something just now that would have done your heart good. As we were crossing the bridge a trout jumped out of that deep hole by the buttonball tree. He must have weighed a pound."

Left alone again, I did some thinking about that fish. A pound trout! Trout that weighed a pound were scarce thereabout. Once I had caught one that weighed $1\frac{3}{4}$ pounds, but that was years ago. I measured on my cane about how long the fish would be, and with the point of it scratched in the soft dirt an outline of the big trout by the buttonball tree. I knew just where the fish would probably be, just back of 2 big stones in the pool, where many of his kin had met their fate in years that were past. How I did long to have a try at him! I could see the tree from the barn, down across the meadow just below the bridge. A long way off it looked to me that morning.

Just then there crawled out of the dirt at my feet a fat angleworm. That worm did the business for me. I caught him, and then poked around until I had 6 more. My rod, thank fortune, together with my line and hooks, was in the barn. With a furtive look at the house, I slipped into the building, and out at another door in the rear with my tackle and headed for the brook, keeping the barn between me and the house. I did not move fast. It was not easy for me to walk with my crutches on the soft ground, but I kept at it, and after a long passage brought up at the brook, just above where I wanted to fish. Sitting on a convenient rock I jointed my rod, rigged my line, hooked on a worm and, limping painfully along, came to the little rapid that stopped in the pool by the buttonball tree.

The squirming lure floated in the swift water to the still depths below. Not a strike. Again, and as it passed the sunken stones it stopped. I felt a gentle pull and the line began to run out, while I helped the

matter all I could by paying out as the fish moved. Letting him have all he would take, I waited for him to thoroughly hook himself. At last I recovered the slack, gave a little yank and the trout was hooked.

Oh, what a time I had then all alone, and on one leg at that! Back and forth, over and across; then to vary the performance the fish would jump clear out of water and do the whole thing all over; but the little steel rod, the silken thread, and the needle-like hook were too much for him. He yielded, but with poor grace. Full 30 minutes elapsed from the time he first struck the hook until he floated into the shoal water and was hauled up on the grass.

Then it was a matter of getting home and how I ever did it I don't know. What my wife said I shall not tell, but the trout weighed a pound and a half.

You should never plunk for a noble fish like a trout. Take him on a fly or let him stay in the water. Carve him as a dish fit for the gods, not hew him as a carcass fit for hounds.—EDITOR.

SALMON KILLED BY BLACK BASS.

Tacoma (Wash.)—Black bass are killing landlocked salmon by tens of thousands in American lake, South of Tacoma. With rows of dead fish making a white streak almost entirely around the lake, more fish are continuously swimming wearily up to the beach to die. Their death apparently results from bodily injury. In every case their tails are missing, and often their sides have been gouged out. These fish are 12 to 15 inches long, being species of salmon. This being their spawning time, it is believed that the vicious black bass, plentiful in American lake, take advantage of their weakened condition after spawning to attack them. The salmon being too large to be swallowed whole, the black bass chop off their tails and as much of their bodies as they can manage.

The mangled fish, suffering from their injuries and unable to hunt food, weaken and finally make for the beach, where they perish miserably while trying to escape their enemy. Residents near American lake say this remarkable occurrence has been noticeable during December for 4 years past.

I referred the foregoing to Dr. B. W. Evermann, of the Bureau of Fisheries, Washington, D. C., and he replies as follows:

I do not think there can be much in the story told in the enclosed clipping. It is more likely that the fish referred to, if really salmon, are simply dying, as all West coast salmon do, after spawning. These are mentioned as landlocked salmon, but as there are no landlocked salmon on that coast, as far as I know, that part of the story is probably mixed. There is a great deal of evidence to show that the black bass introduced into trout and salmon waters of the Northwest do great damage to the young of the different *Salmonidæ* native to those waters; but that black bass would

seriously injure salmon or trout 12 to 15 inches long is a little too fishy a story.

I am not familiar with American lake, but I should not be surprised if the fish referred to are the small form of the blue-back salmon (*Oncorhynchus nerka*). This species reaches a length of about a foot and spawns ordinarily in the small streams tributary to lakes in that region, late in the fall or early in the winter.

ON THE WEBER.

My brother and I had long contemplated a fishing trip. We at last decided to go on the Weber river, and with 5 friends set out July 11.

We were in camp the day after leaving Salt lake. Joe Vernon caught a mess of trout for supper, while the others pitched camp. After breakfast next morning we went to J. E. San, living just above where we were camped, to ask him to supply us with eggs and milk during our stay.

The 3 boys in the party decided that night to be up early for the morning fishing. Getting out at 5 a. m., we walked a mile up stream and caught 20 fair sized mountain trout. Two days thereafter we just laid around camp and enjoyed ourselves.

We fished off and on during the following week, keeping the camp supplied with fish enough for our needs. We could have caught hundreds of pounds if we had tried. One party, camped near us, caught and salted down over 500 trout, about 150 pounds.

One morning my brother and I got up and had breakfast about 4 a. m., and then went fishing. We returned with 30 trout, and we did not fish any more for 3 days.

Game is abundant where we were; bear, deer, cougar, chickens, quails, trout and herring.

F. H. Strickley, Salt Lake, Utah.

SEND ME MEASUREMENTS.

Professor H. M. Kinsley, of Hoboken, N. J., superintendent of schools of Hudson county, has sent me 2 photos of muskalonge which bear on their reverse sides these memoranda:

"4 feet 1 inch long, 27 pounds weight, captured in the St. Lawrence river August 15, 1903, at 11 a. m.; 4 feet 8 inches long, 37 pounds weight, captured in the St. Lawrence river August 24, 1903, at 5:30 p. m."

I should be glad if anglers in general would send me careful and complete data as to length, girth and weight of all large fishes they may take. It is not usually necessary to have photographs of such fishes, but such data as the foregoing are valuable and interesting. I am often asked what a muskalonge will weigh which measures 4 feet 6 inches in length, for instance. If those who are fortunate in landing big

muskalonge, bass, trout, or other game fishes, would send in accurate measurements and weights this would enable each angler to judge for himself, when he measures a fish, as to what it would weigh. It often happens that a man gets a big fish when he does not have scales with him, but he can always carry a tape measure in his pocket.

—EDITOR.

DOES ANYONE KNOW THEM?

I send you a clipping from one of our local papers. One of its owners and publishers has been up North, where he did some fishing.

I admire the way you go after the game hogs and hope you will roast this fellow to a turn. RECREATION is the best magazine I know of and I can hardly lay it down until I have read it through.

H. G. M., Essex, Ia.

The clipping referred to contains an article, occupying nearly a page of the Shenandoah, Ia., Sentinel, recounting the fish-slaughtering exploits of the newspaper man and 4 Nebraska swine.

Reininger says in reply to my inquiry regarding this report, "The best 3 hours' fishing in the Crow Wing lakes gave 2 of us 21 big mouth black bass that averaged a trifle over 4 pounds."

This means over 90 pounds of fish for 2 men in 3 hours.

Reininger goes down in the fish hog register as No. 1,009, and I regret that he did not give the full names and addresses of his 3 fellow rooters, so that I might have numbered them.—EDITOR.

FISHING CLUB VINDICATED.

Local anglers have been awaiting with great interest developments in the case of the Bellwood Rod and Gun Club against J. H. Sheehan, of Johnstown, who, claiming authority as deputy fish warden, recently invaded this county and summarily tore down printed notices which had been posted along Bell's run proclaiming it a stocked and closed stream under the act of 1901. The local officials of the Blair county branch of the League of American Sportsmen, at the request of the Bellwood club, at once reported the matter to the State Fish Commission, and asked for a thorough investigation of the matter, including the insinuation made by Sheehan that Bellwood people had themselves fished in the stream, a fact indignantly denied by the latter, who claim to have held the prohibition absolutely inviolate.

The requested investigation was at once set on foot by Hon. M. F. Meehan, president of the State Commission of Fisheries. After an exhaustive inquiry into all the circumstances of the case, including the reported high handed and altogether indefensible actions of the Johnstown officer, the decision of the commission was announced this week. Deputy fish warden Sheehan was summarily removed from office, and the commission announced that they would send as soon as possible 20,000 trout fry to Bellwood free of charge to restock the stream, which had become depleted through the public action of the officer.—Exchange.

I wonder if Sheehan does not think he was slightly previous in his action.—EDITOR.

NIBBLES.

A subscriber sent me a newspaper account of the taking of 69 black bass in one day by W. A. Withmar, of Buffalo, N. Y., and C. J. Bellinger, of Watertown, N. Y. The clipping in question shows a reproduction of a photograph of 69 black bass. The caption of the photograph reads thus:

"Catch of bass made July 18, 1903, by W. A. Withmar, of Buffalo, and a Watertown newspaper friend."

Replying to my request for confirmation or denial of the report, Mr. Withmar says:

Your information regarding the catch of bass is correct as far as I remember.

Mr. Bellinger says:

The fellow who informed you that a friend and I caught 69 black bass in one day is a fish liar without a conscience.

The reader can draw his own conclusions.

—EDITOR.

The Des Moines river has been for years a muddy stream when at flood, becoming clear at low water. For 2 years past there have been extraordinary floods, and at no time has the water been clear; but the high water in the stream, muddy though it has been, has served to dam the little rivulets and creeks flowing into it, and these form so many ponds of clear water. Having observed bass lying in some of them I took a few live minnows and went to a place where I have always had good luck with channel cats. I took out a dozen bass in a little over an hour, the smallest weighing $\frac{3}{4}$ of a pound and the largest 3 pounds. Next morning I tried again, catching 15. Then a hard shower muddied the creeks and ended my fishing. Can any reader of RECREATION tell how to get bass to bite when the water is muddy?

E. R. Harlan, Keosauqua, Iowa.

I am captain of a 5,000 ton boat plying on the great lakes. While at Huron Harbor, Lake Erie, one day last spring, Henry Damon and I fished from East pier. Between 7.30 and 11 a. m. we caught 115 sand pike, 3 perch, 2 rock bass and a 15-pound German carp. The combined catch of 12 other men, fishing within 50 feet of us, was less than ours. Our fish were 8 to 12 inches in length. As they furnished 2 meals for 25 hungry men, we do not think we were hoggish in taking them.

The real fish hogs of Lake Erie are the market fishermen. Their pound nets extend from both sides of the pier 5 miles out in the lake. It is said they skin their fish at the nets and by so doing are able to market black bass as perch.

GUNS AND AMMUNITION.

Anybody can shoot all day, but a gentleman always quits when he gets enough.

FARMER'S BOY NOT GUILTY.

The article in March RECREATION by W. J., of Philadelphia, Pa., moves me to reply. As an advertisement of the killing power and deadly effect of the automatic gun, this article is a distinct success; but the picture he draws shows a lamentable lack of knowledge concerning the small game conditions throughout the more settled portions of the country.

I speak from personal observation and in behalf of the farmer's boy, whom W. J. and some other sportsmen would deprive of owning a modern gun, if they could make the price. To the man who has hunted all day in this country, walking up his birds and taking occasional snap shots at long range in heavy cover, the picture of the farmer's boys going forth with the automatic gun, "Firing 2 shots, killing 5 birds on the ground and 3 more on the rise, making 8 out of a covey of 15," is amusing. The thing more likely to occur is this: The murderous farmer boy, who, by the way, owns the land on which the gentleman sportsman usually goes forth, during his work about the farm in the summer and early autumn marks a brood of quails, which he watches with jealous care, and waits impatiently for the opening of the season when the law is off that he may have a few days' hunt, after the summer's work. This game butcher owns no trained bird dogs and seldom has a modern gun. If by any luck he gets a brace of birds in a day's hunt he is proud and satisfied. But, supposing he defers his hunt a few days after the opening of the season. What are his chances for exterminating the game then? Just visit the city stations, during the first of the shooting season. There you will see the man, bound for the country, who will use the automatic gun, the 2 or 3 dogs and every known facility that money can buy, for bringing home the required number of birds for his game dinner. If these fail he pays liberally to local hunters for assistance; but he gets the birds, and any local game warden having the presumption to ask the number, gets little satisfaction. I am not a champion of the automatic gun or the repeater. In fact, I do nearly all my shooting with a single shot rifle; but the man who so often contributes the idea to RECREATION that a shooter has only to go into the brush with his automatic or pump, swing his gun around, shooting the 6 rapid shots, and pick up the remains of a covey of birds, has only to try it to be convinced that all is not "dead bird" which gets up before a repeater. Moreover, this

same engine of destruction is seldom found in the hands of the country sportsman or the despised farmer's boy.

F. B., Lisle, N. Y.

ANOTHER VOTE FOR ROBIN HOOD.

About 25 years ago I commenced shooting with black powder, of course, and since that time have shot nearly all the well known brands of black, bulk and dense smokeless. Still I am always looking for something better, hence I always carefully read the Gun and Ammunition department of RECREATION.

Of all brands of powder used by me to date, Robin Hood, in my opinion, is the best. For cleanliness, penetration and uniformity of pattern, especially at long range, it excels any bulk powder I have ever seen; while considering the high velocity given by it, the recoil is much lighter than any of the dense powders with a load that gives equal velocity. It is, as its manufacturers claim, a slow burning powder, starting the shot slowly but reaching great velocity by the time it leaves the muzzle, giving remarkable killing power. Since shooting Robin Hood I have had fewer crippled birds than ever before.

The best brands of dense powder give about the same velocity as Robin Hood, but they explode so quickly that the recoil is much greater and the pattern not so good.

The only fault I can find with Robin Hood, and I have shot a lot of it, is that it makes enough smoke in thick woods and on damp, still days to interfere slightly with the use of the second barrel. On such days I have made a practice of taking along a few dense powder shells for the right barrel; then if I miss with that the bird scarcely ever fails to fall to the left if I hold true.

As a rule I load my own shells, for I have experimented at target until I have found what will give the best results with my guns. No set formula can, in my opinion, be given to apply to all guns and conditions; in order to get the best results out of a given gun, experiments must be made with it at the target.

My favorite load for trap or brush shooting is 3 drams Robin Hood in a 2 3/4 inch Leader shell, one B shot wad, 3 black edge wads capped by another B shot wad, 1 1/4 ounces chilled shot and a C shot wad, with 1/4 inch round crimp. For duck shooting I increase the powder to 3 1/4 drams. With that load I get my bird, if it is within 60 yards and I can hold true, and I do not

come home at night with a lame shoulder or a headache either.

Try it and let RECREATION tell us the results.

Quilp, Boston, Mass.

CONDEMNNS THE AUTOMATIC.

I have read in RECREATION several protests against the automatic gun, and I heartily approve the sentiment expressed in those letters. It seems that the game hogs and some of the gun makers are determined to wipe out the remnant of our game birds. Not being satisfied with double guns and repeating shot guns, these men want still more murderous and destructive weapons so they can finish up the birds still faster than they have been doing.

I am heartily in favor of the enactment of laws in all the States to prohibit the use of both automatic and pump guns, and I should be glad if all such laws provided long terms of imprisonment for men who violated them.

I have lived in the West 35 years, and most of that time on the frontier, where game of various kinds was abundant, yet I never killed more than was necessary for subsistence and never killed an animal until the meat supply in camp was practically exhausted. One deer or antelope was always enough for me at a time. Many a day I have watched dozens of these animals and buffalo feeding within rifle shot and never disturbed them as long as I had 2 or 3 days' supply of meat on hand.

I was always content with 2 or 3 prairie chickens or one turkey for a day's shooting.

In Routt county, Colorado, in 1891, while on a 5 weeks' hunting trip with W. A. Giles, we killed 3 deer and one of them we gave to a ranchman who asked us to kill one for him because his sight was so poor he could not shoot successfully.

During that time we saw as many as 50 deer in a day, but no such number could be seen there now. The game hogs, head hunters and buckskin hunters have thinned them out until it would be difficult to find half a dozen deer in a day on the same ground. The same is true of grouse in that country; yet certain gun makers are anxious to make it possible for the butchers to exterminate in short order the few coveys that remain.

F. W. Hambleton, Pueblo, Colo.

AN EXPERIENCE WITH NITRO.

For some time I have followed up the reloading of my own shot gun shells, and have been rewarded by highly satisfactory results with the exception which I am about to state.

I selected a number of solid and firm Winchester Leader shells, $2\frac{3}{4}$ inches long,

12 gauge. These I carefully resized and primed with the long Winchester No. 4 primer. I then charged them with 3 drams of Dupont nitro powder and seated firmly on the powder charge a Winchester grease-proof 12 gauge wad. Next a $\frac{1}{4}$ and an $\frac{1}{8}$ inch black edge 11 gauge wad and $1\frac{1}{8}$ ounces of shot covered with a cardboard wad. The shells were then firmly crimped and I went rabbit hunting.

I fired several shots which were effective in proportion to the accuracy of my aim and then came a miss fire.

It was the first one I had ever known the gun to make. When I examined the shell I found that the primer had exploded and that the crimp in the shell was nearly straightened out. As I had heard that a strong primer was necessary to ignite nitro powder, I concluded that was a weak one and had failed to explode the powder, but when I unloaded the shell I found the powder entirely burned up and the inside of the shell and the first wad badly charred and blackened.

How this powder could have burned when so closely confined and not even expel the charge from the shell I do not understand. Neither do I attribute it to any defect in the Winchester or Dupont goods, but to my own lack of experience in loading nitro powders.

If some brother sportsman could elucidate this point and suggest a remedy for similar occurrences in the future, I should like to hear from him through this magazine.

G. L. Hale, Chardon, O.

TOO MANY GUNS.

During a recent stroll through the woods near this city it occurred to me that the supply of guns greatly exceeds all legitimate demand. The woods I speak of have long been stripped of every variety of game, yet firearms were being discharged on all sides. Most of the shooting was done by young fellows from the city, representatives of the great class of would-be sportsmen who delight in killing anything, no matter how small, that wears fur or feathers. To this class may be charged the depredations that are forcing all land owners near towns and cities to post their property against trespass. The posting of land has become so universal in some localities that the conscientious sportsman is entirely deprived of privileges he formerly enjoyed and appreciated, but the hoodlum gunner respects no prohibition unless it is backed by physical force.

Michigan's law is framed to protect all song birds and insectivorous birds. But the forests do not teem with game wardens, hence all birds, migrate and resident, fall victims to the chap who carries a gun.

During my walk I saw several redhead and speckled woodpeckers lying in different stages of decay, slain by those whose all absorbing ambition is to kill. What a silent void is the wood where the forest carpenter no longer beats his energetic tattoo on some dry tree!

At the rate this extermination is proceeding, soon there will be no gray squirrels and few birds near the towns. What will he who carries a gun do then, and what will gun manufacturers do? Will guns continue to be turned out at the same, or an increased rate, and the rising generation continue to purchase while trees and stumps hold out for targets or is the time approaching when guns will go a-begging?

J. A. Newton, Grand Rapids, Mich.

THEY DO NOT FORGET PETERS.

Asbury Park, N. J.

The Peters Cartridge Co.,
Cincinnati, Ohio.

Dear Sirs: Your letter in RECREATION is beyond comprehension, and has caused considerable comment among our sportsmen.

I can substantiate C. W. Radcliffe's statement that Peters shot gun shells will jam in the Winchester pump gun. A friend and I were shooting, he using your shells and the Winchester gun. He could not get them to work and we finally exchanged shells. He took mine, after which he had no trouble; I, having a Packard, could use your cartridges.

Since then, J. D. Newlin & Co., of this place, have never carried your shells in stock.

I do not condemn your ammunition, but simply say that your cartridges will jam in the Winchester shot gun.

What Mr. Shields has done for sportsmen is, beyond words to express, and it is the bounden duty of every true sportsman to stand by him in such matters. It is the least return we can give him.

Unless we again see your advertisement in RECREATION we shall pass resolutions in the 4 large gun and rifle clubs in this vicinity, with a membership of over 500, not to use any of your ammunition.

We, to a man, believe you have treated Mr. Shields unfairly and trust you will see your mistake.

E. B. Reed, M. D.

HOW TO CLEAN RIFLES.

After using nearly all the leading makes and calibers of rifles, I was foolish enough to try a second Marlin. I have at last settled on a 25-35 Savage. For such game as deer, turkeys, geese, etc., it is perfection. By reloading shells with 86 grain bullets

and a few grains of powder, it is as good as I want for small game. As a target rifle it is equaled by few, if any, and excelled by none. Have made a better score with it at 200 yards than I was ever able to make with the 32-40 or 38-55. This was a great surprise to me.

Have tried all kinds of devices for cleaning small bore, smokeless powder rifles and have found nothing which suits me so well as a brass rod with head and absorbent cotton. Pinch off a small piece of cotton, wet it and force through bore. Repeat this till cotton comes through unsoiled. Finish with a few dry pieces, then draw through a well oiled wick plug. You can then rest assured that your rifle will not rust.

Sportsmen who are always complaining about the fine red rust produced in their rifle barrels by smokeless powder, simply fail to remove the residue of powder before oiling rifle. They think they get it all out, but do not. To all who are thus troubled I would say, work on your rifle with rags till they come through clean. Then get some absorbent cotton and you will be surprised to see what you can get out after you think your rifle is clean.

E. F. Pope, Colmesneil, Tex.

DISAPPROVES WINCHESTER'S COURSE.

I have been a reader of RECREATION nearly 2 years. I see statements of people who say they could not get along without it. I am like the man who, after eating his first olive, was asked if he could eat them. He said he could, but he did not see why he should. I could get along without RECREATION, but I do not see why I should.

I see that many sportsmen condemn the pump gun and request the Winchester people not to put an automatic shot gun on the market. I have never seen an automatic shot gun, but from what I have seen of the pump gun, I find only one redeeming feature in it, namely, the frequent accidental discharge, which will tend to make a few less bird dogs and game hogs. I use a 16-gauge Lcfever, and it is either a clean miss or a clean kill every time. I would rather miss a bird than have to shoot it again or have it get away wounded. I would rather make 2 or 3 good hard shots and score clean kills in a day than to pot all the game I could carry. I have used Winchester shells and wads and have always found them good; but if the Winchester people put that awful game destroyer and game hogs' weapon called an automatic shot gun on the market, other ammunition will be good enough for me. I hope that at the next session of the legislature of Pennsylvania a law will be passed prohibiting the use of any repeating shot gun other than a double barrel.

R. B. Edmiston, Milan, Pa.

THE .303 SAVAGE FOR DEER.

In March RECREATION, Arthur A. Brock asks to hear from someone who has used the 44-40 on deer. I used a 44 Winchester several years, and killed many a fine buck with it. I considered it a fine gun, and so it was for its time, but it has outlived its usefulness. It is no comparison to the more modern small bore smokeless rifles for big game. If Mr. Brock really wants a good deer gun, I advise him to get a 303 Savage. They cost a little more than some of the other makes, but they are worth the difference. If he believes in the preservation of game, I advise him to get a Marlin. I carried one 2 or 3 years, and I know of several big bucks still at large that would not be if I had had a Savage. I have used nearly all makes of sporting rifles, commencing nearly 30 years ago with a muzzle loader, and I consider the 303 Savage superior to them all.

I buy RECREATION every month from our dealer, and it is a great magazine. If it was not for RECREATION the game hogs would never get roasted. I like the fight it is making against the automatic shot gun. I used to be a game hog myself, before I got hold of RECREATION, but it has made a decent sportsman of me. I hand it around to my friends, knowing that it will do good.

F. S. Carter, Gilroy, California.

SMALL SHOT.

Your action against the manufacture, sale and use of automatic guns is certainly in the interest of game protection, and as such should be approved and aided by all sportsmen. Repeating guns are to a great extent responsible for the rapid destruction of the game. They are built for that purpose and are fast fulfilling their object. The plea of the manufacturers that the game can be protected by law by prohibiting its sale, limiting the season and amount of game to be killed, would be all right if the law was thoroughly enforced and respected; but such is not the case. Everyone knows how game is smuggled in to dealers and how they dispose of it to private customers; and every sportsman knows how difficult it is to police large game districts and that where one offender is convicted and punished a hundred equally guilty escape even suspicion.

It is evident that the manufacturers believe the game is doomed and that it is a case of making the most of a good thing while it lasts.

Geo. A. Tremper, Helena, Mont.

READERS PLEASE ANSWER.

I should like to have your readers tell what they think of a 16 gauge gun, for all

kinds of shooting, including ducks occasionally. I should also like to know if a gun bored for nitro powder will make equally as close a pattern when black powder is used. I have owned a cheap gun 10 years, stamped on frame "Prize Machine Gun." It is a 16 gauge, with 36-inch barrels. Don't laugh at the length. Before I strained the choke out of this gun by using buck shot I could outshoot any other gun I ever saw. I once killed a duck with my 16 gauge at the longest distance I ever saw game killed with a shot gun. Two years ago I went to Great South bay to shoot ducks. I borrowed a 10 bore gun that weighed 11 pounds and killed as many as I expected to, but before I finished shooting I wished for my old 16 bore. I could have done as well, and my own gun is so much lighter. I always use No. 4 shot and black powder in my 16. Smokeless powder scatters the shot in this gun.

E. Kelly, Arkville, N. Y.

I own a Winchester pump gun and like it, but will not defend it, for I see the point you are trying to impress on sportsmen. A man may use a repeating or an automatic shot gun and quit when he has a fair bag, but a game butcher may also use one and will not quit as long as there is game in sight. Anyone who has used both the repeating and the double gun knows the former is more destructive in the hands of a game hog. I sincerely hope you may be the means of inducing the manufacturers of automatic shot guns to stop making and putting them on the market.

I now own a .303 Savage, and after trying and comparing it with other rifles I find it leads them all. The short, strong action and the hammerless feature are among its many good points. It is in a class by itself, and anyone who is in doubt what kind of a rifle to buy will make no mistake if he gets a .303 Savage for a high power or a 38-55 Savage if he prefer one not quite so strong.

Wm. S. Ferm, Hurley, Wis.

As a constant reader and a sincere admirer of your magazine, and of your work, I wish you would tell me, through RECREATION, the advantage or disadvantage of the square nosed cartridge. As an illustration, take the old and well known 44 C. F., bottled necked and square nose. Has the square nosed bullet any advantage over the round or sharp pointed bullet? Has the bottled necked cartridge any qualities over the straight shell?

I am a stranger in this great city of

bricks, mortar and iron, and my heart often becomes sick with longing for the woods in which I was reared. RECREATION is my solace and delight, and at the same time my sorrow; for when I read of some of the glorious trips to the woods described in your magazine, it makes me wish I had never left my native heath. Long life to both you and RECREATION.

J. M. P., New York City.

In looking over RECREATION, I see that Mr. W. H. Pringle wishes to know how to keep a gun from rusting. I have found the following method effective: After the hunting season is over, fill the gun barrels with lard oil, plug up the ends and set the gun away until the next season. The inside of the barrels will look more like silver than steel after such treatment, and the same oil can be used again. If the barrels have contained any rust the oil will remove it in a few days.

I hunt in Florida, all along the coast from Tampa to Key West. I once sold a fine Parker gun on account of its being slightly rusted, but since I have tried lard oil my Ithaca, after 5 years' use, is as clean as it was the day I bought it.

John W. Steil, Sidney, Ohio.

Will you kindly inform me if, among hunters, it is generally known that a 30-30 shoots higher in a high altitude than in a low one? I have never seen mention made of it in any of the magazines. My experience is that a 30-30 will shoot 5 to 6 inches higher at a distance of 125 to 150 yards and in an altitude of 7,000 feet, than it will at the same distance in an altitude of 1,200 feet. I have wondered if a black powder gun of low velocity will follow the same rule. Persons in the low altitudes of the East, anticipating a hunt in the Rockies, may save themselves the disappointment of scoring a miss on some fine trophy, as was my experience, if they bear the above fact in mind.

Dr. A. C. Wheeler, Roswell, N. Mex.

Will RECREATION readers please answer?
—EDITOR.

I enjoy every word in RECREATION, especially the gun and ammunition department. I am glad to see you take the stand you do in regard to the automatic shot gun, and I trust it will not be put on the market. If it is, we must say good-bye to a large portion of our game. I live in one of the best game portions of Manitoba. Ducks and geese are plentiful here in the spring and fall, and a large number are shot while resting here on their way North and South. If the automatic is sold a great many more

of them will be killed. The repeater is bad enough on the game, as it is.

Norman T. Miller, Virden, Man.

Your Legislature has recently passed a law prohibiting the use of the automatic gun. Long live the men who voted for that measure.—EDITOR.

I want a 12 gauge shot gun, principally for squirrels and chickens, and would like the opinion of readers of RECREATION as to the best gun to buy. What length, weight and bore shall I choose? What is considered the best American made gun? How can I determine the length for a stock?

G. E. Cecil, M.D., Flat Lick, Ky.

Have any of RECREATION's readers had experience with a Savage 32-40? I think the 32-40, with high power cartridges, is as near the all around gun as one can get. To subscribe to RECREATION is the best thing a man can do with a dollar. It is the best magazine of the lot.

E. R. Fellows, Brooklyn, N. Y.

I think of buying a single barrel gun, on account of its superior sighting, and an Elterich rifled bullet shell, 6 inch barrel, to use in it. Is the combination practical? Is there a possibility of damaging the choke or otherwise injuring the gun by using the rifled bullet shell?

J. P. Tilson, Wales, Mass.

What do you consider the best long range rifle?

What do Lee-Mitford and Martini rifles cost in this country?

Lee Covell, Charlevoix, Mich.

Will some reader of RECREATION please answer?—EDITOR.

I endorse your sentiments in regard to the automatic shot gun, though I have a 22 rifle on that plan with which I have a lot of fun; but few men can shoot ducks on the wing with a rifle. I shall do all I can to discourage the use of the automatic gun.

M. Kelly, Seattle, Wash.

Please inform Subscriber, Los Angeles, Cal., that I was using Winchester metal patched soft point bullets with a full charge of 30 caliber Dupont powder in a U. M. C. shell when I shot the deer 5 times as printed in September RECREATION.

E. G. Dewey, Hanover, N. H.

He (at the theater): "Would you mind keeping that hat on?"

"Keep it on! Why, I was just about to take it off."

"I know it. But I don't want to see any more of this play than I can help."—Life.

NATURAL HISTORY.

When a bird or a wild animal is killed, that is the end of it. If photographed, it may still live and its educational and scientific value is multiplied indefinitely.

BIRDS AT THE FLORIDA KEYS.

Flamingo is at the extreme Southern end of Florida. The people here are truck growers, using the rich, shallow soil to raise onions, tomatoes, sugar cane, bananas and other staples. They are intelligent, and law abiding, including the game laws. We have curlew, teal, ducks, pelicans, cormorants, herons, cranes and many other waterfowl in the marshes; while deer, bear, panthers, lynxes, raccoons, opossums and smaller burrowing animals are numerous. Our rabbits are shy and I have never seen one yet, though signs prove them to be plentiful.

Vegetation is peculiar; black and red mangos, palmetto, buttonwood and dogwood cover the hummock land. The dogwood is not like that of our Middle States. Cacti and vines grow thickly in these hummocks, while air plants that resemble pineapples live on the trees.

This island is about 20 miles long and 6 miles wide. On the South, Florida bay splashes, and Whitewater bay is on the North. To the West we see the Gulf. The island is composed of a series of keys, or patches of hummock land, surrounded by salt prairie. Most of this prairie is overflowed in summer, but comparatively dry in winter. The long saw grass hides many creatures. We have a bird that these people call prairie chicken, a waterfowl that I believe to be a kind of darter. It has a coarse, cracking, squawk and greenish yellow legs and is colored brownish; something like a brown leghorn hen.

The "man-'o-war hawk" is a big bird that sails over the bays and occasionally over these marshes. He has a big stretch of wing and a long neck. I have never been close enough to one to give a good description, but he has a neat appearance, rather angular, and is a fishing bird. There is a "gull hawk" here that looks much like a white gull, but has a shorter neck, a heavier beak, and shorter, stiffer looking wings. He stays over the salt water.

Our post-office is named for a bird that is seldom seen and is considered the wildest, shiest bird in existence. He has sometimes been seen here. Near here is a rookery where curlew roost by thousands. Every evening big flocks come in from the day's work of finding food. The young ones are a slate blue color, which vanishes in old age, leaving them almost white. We have plenty of meadow larks, but no quails nor grouse. Doves are abundant and are not wild. Hawks are too numerous; fish

hawks, blue hawks, gray hawks, red hawks and some that I do not know. The smaller sparrow hawk also exists. We see the butcher bird everywhere. He is a brave little warrior and I have seen them chase even the largest hawks away.

The butcher bird has been frequently accused of wrongdoing that can not be proved against him. Because a sparrow happens to be impaled on some thorn, or a grasshopper or a beetle meets with such an accident, it does not follow that a butcher bird did the cruel deed. When someone tells me he has actually seen the bird in the act of filing meat for future reference, I shall believe; not until then.

The butcher bird is my friend, and should be everybody's friend, because he is all the time working for us human beings. The following facts will, I hope, put truth before some readers of RECREATION.

The true name of this bird is unknown to me. I believe he is the Carolina shrike. He is small, with a general slate blue color, a black, stocky beak, with a black line running from bill to eyes. His head is rather flat and broad. A black strip runs across each wing and his tail is of medium length. He is a neat, military looking bird.

Two of these birds spend most of their time on the end of our ridgepoles. We have 2 shacks and these birds flit from one to the other, always alert. With remarkably keen eyesight they scan the ground and woe to the worm which comes out within 50 feet of our butcher bird! With a quick "stoop" the bird is on his prey and back on his perch.

The butcher bird is belligerent, fighting hawks and large birds more eagerly than smaller ones. Mine (I claim these 2) do not molest the only mockingbird I see in this neighborhood, nor do they trouble the mosquito bird, which is tiny. The truth is, the brave little fellow appears to feel responsible for the safety of his helpless neighbors, and keeps a lookout for hawks. The air of responsibility sometimes makes him seem worried.

When annoyed, or when night comes and he is still hungry, he utters a plaintive cry, not unlike the long drawn chirp of a young chick after the old hen has turned it loose on the world and it is troubled about something.

One evening I killed a small mule rat in the corn bin. Taking the pitchfork, I put the rat on the gable end, where my friend was generally found. Soon he came, and

noticing the strange object, he was wary, jumping around the rat in nervous haste. Before many minutes he realized that it was dead. Then he caught it in his little talons and flew out into the weeds. I failed to find him after that, though I tried, in order to see if he would put the rat away for future use.

I believe some game laws give hunters a right to kill this bird; why, I do not know. I have lived in several localities, under varying conditions, and have yet to see any real harm in this little warrior. If he eats a grape now and then, he eats a hundred or so worms to pay. If he impales sparrows on thorns, he drives away hawks to atone. Watch him, and condemn him when he proves his guilt.

One of the most common birds in the United States is the meadow lark, frequently called the field lark. His habits vary, I suppose, under varying circumstances. In Alabama, they live much like quails, in grain and stubble fields; thus earning the name of field lark. This is in the winter, when they go in flocks. In summer they seek the shady places on creeks, where they warble sweetly and call to each other. They are mated then; no more flocks.

Down here on Cape Sable we have them in considerable numbers on the prairie. The quail does not live here, only 2 having been seen for some time. In fact, there is no record of any for over 7 years, except those 2. Some mean spirited man shot those. Therefore the lark must find other modes of life than imitating quail.

Every day I see meadow larks on some tall weed or log end or anthill or clump of tall grass, warbling their joyous songs. One seems idle but happy. Wait! He darts down, is busy a minute or 2 and returns to his perch on the weed. He has eaten a worm. All day they answer one another across the prairie. We seldom see more than 3 together.

Larks eat almost as varied a diet as English sparrows. One man here, living alone, has them so tame that they come to his feet to eat oats he scatters for them.

The lark is a gentle, innocent, helpless bird and is not a fighter.

Another common bird here is the kildeer plover, generally called kildee. His habits here are not different than elsewhere. He is always fond of swampy ground, preferring open fields. He is a pretty bird, shaped not unlike a dove. His feet are light colored, appearing clean, from much wading. The marking on kildeers is not easily described. When flying he shows a good deal of white; when walking he looks gray. He has a wild, shy expression, which he lives up to. Few birds seem so incapable of fight when attacked. A few weeks ago I heard a kildeer crying in great dis-

tress. A small, red sparrow hawk, scarcely larger than the kildeer, was carrying him away. I tried to frighten the hawk, but he simply refused to drop his prey and flew heavily into the hummock.

There is one bird that I wish someone would identify for me. This is the "mosquito bird," as we call him. He is small, has a greenish gray back, a yellow gray breast and is not unlike what some people call a "lettuce bird" in Virginia. He is not the bird we see around sunflowers, looking like the Baltimore oriole. This mosquito bird flits around, apparently living entirely on mosquitoes. He comes within 2 or 3 feet of men, having learned not to fear them. In the mornings he can be seen hanging on the window screen, catching the skeeters as they try to get through.

Among my friends in Florida are crows, lizards, hawks, and others. Hawks here do not seem anxious for feathered prey, preferring rats and moles.

Of course, we know tragedies occur beyond our human circles, but are not often led to believe scandals do, too. Among my Florida friends are a rice bird, a mockingbird, several meadow larks, and, now, one butcher bird. There were 3 of this last kind.

The first tragedy occurred about a month before I write. We have a barrel sunk in the earth to use beneath a lye hopper. The hopper has been destroyed, but the barrel is there, half full of water. My friend the butcher bird evidently tried to get a drink in this and was drowned. For several days I missed him; then I happened to glance in the barrel and saw him.

The second tragedy occurred a day or 2 ago, also to a butcher bird. We have been putting out a phosphorus roach poison, and I am afraid the little fellow ate some roaches. He had a habit of staying on the roof, of our shacks. We had also been using Paris green in the cabbage patch. Whatever the cause, I found him one day on the gable end, looking unhappy; not alert as was his custom, but sitting on his feet. Two hours later he was dead.

The scandal is deeply interesting. The old romance of "Cock Robin" has been equaled, if not surpassed by my friend, the rice bird. He is about the size of a crow blackbird, and nearly as black, except for 2 red spots, one on each wing. Each spot is bordered by an orange band.

The larks and other birds come to our shack to drink out of our water barrels, the dry season being unusually dry this year. About a month ago I heard what I supposed was a lark warbling very hoarsely. Wondering if it could be ill, I looked out of the window and saw my rice bird. He was doing his best to imitate the meadow lark.

Now, I like to reason out these things, and I find few of our wild creatures given to idle talk. Accordingly, I watched, each morning. When a jay mocks a hawk, he wishes to scare smaller birds from their nests. He likes eggs. It is not wit, nor humor. What made my rice bird talk lark language?

Thus far I have not answered the question, but the same lark comes each morning with the same rice bird, and they answer each other regularly. Frequently the rice bird blunders and ends with an awkward squeak.

One of my guesses is that both of these birds have lost their mates and have been driven together. I will not go so far as to say they will mate, but evidences are in favor of such a theory.

Over in the East we see the distant Everglades. Many stories are told me about these mysterious regions. Gangs of outlaws are reported hiding in there; wild animals are numerous and Indians can be met, too. How true some of these stories may be, I can not say. We know that the Seminoles hunt through the swamps, we can be confident as to game and fish; but the outlaw tales are unproved, to me.

Sportsmen would find our place a good one for hunting or fishing.

Thos. H. Williamson, Flamingo, Fla.

PROTECT THESE WANDERERS.

March 3d was warm and we had a heavy thunder storm. It grew calm rapidly and the next morning was only 4 degrees above zero. As I was going down Main street I saw a duck on the sidewalk and when I drew near I found it to be a redhead. I was within 6 feet before it flew and then it only went 50 feet. I again tried to catch it, when it flew 100 yards where it was caught by a boy, who is now keeping it. The duck acted dazed and was almost starved to death. Can you explain how it came here? We have had no warm weather. The ice on the river is 3 feet thick and all the small streams are frozen. It has been the hardest winter in the memory of the oldest inhabitant.

Lyman Brooks, Charlestown, N. H.

This duck, like thousands of others, had, of course, been flying North to its summer breeding grounds and was probably in company with a large flock. It was doubtless a young bird and being weaker than its companions it gradually became exhausted and had to drop out of the flock. It had probably wandered about the fields or the village some hours before you found it, without being able to get food and was consequently exhausted. It was, however, little worse off than the average duck which alights in ponds and rivers from

which the ice has lately moved, while the flocks are on their way to their breeding grounds in the North, yet many American shooters disgrace themselves by killing these poor birds while in this half starved condition. In all the States which have laws prohibiting spring shooting there are men, claiming to be sportsmen, who are clamoring for the repeal of these laws and who state that such laws deprive them of an inalienable right which they should be allowed to exercise.—EDITOR.

PROTECTING RUFFED GROUSE.

The time has come when the ruffed grouse should be protected entirely for a period of years, in those parts of the country where they have become exceedingly scarce. In this section, and as far as I can learn in every other well populated section throughout New England, at least, their numbers afford only the faintest semblance of sport. Increase of hunters, modern arms and cutting off the forests have combined to thin them down nearly to the point of extermination. Shall we let the work go on until this noble bird is forever lost to us? Who would not enjoy seeing the grouse as plentiful as in former years? If that were so, could we not get more pleasure in hunting them with the camera, or even watching them and listening to their spirited tattoo echoing among the hills than can be derived from continued destruction?

Let us hear what brother sportsmen think of this scheme of protection.

John L. Woodbury, Cornish, Me.

A PET WOODCHUCK.

In May last a woodchuck was caught by a hunter and brought to this city, when apparently only about 4 weeks old. He soon grew too large to keep in captivity, so we let him have his freedom, but he would not leave the locality. He took refuge under the barn, and made his appearance every day for his bread and molasses. Last October he failed to appear, and thinking it was too early for him to hibernate, we gave him up for lost. The 5th of March he put in his appearance again. He is very tame with people he is accustomed to being fed by. If they walk to the lawn and return without his daily rations he will follow them to the house and even pull at their clothes.

I am a lover of nature, and spent my younger days almost continually in the woods.

George Mallett, Defiance, Ohio.

WAS THE CROW GUILTY?

December 6th, J. C. O'Brien, of this place, was driving in a sleigh not far from this village, when he noticed in the road-

way in front of him, where no other track of man or animal appeared, the footprints of a rabbit evidently traveling at a high rate of speed. Not far ahead he presently saw in the road a crow in the act of devouring the freshly killed carcass of a full-grown rabbit. As he approached, the crow seized the rabbit, dragged it several feet to one side of the road, and flew away. Examination showed that the tracks of the rabbit ended just where the crow was first seen with it. From the appearance of the blood and the body of the animal, the rabbit had been but lately killed. Circumstantial evidence would seem to convict the crow. Is this an unusual experience?

H. W. Carter, Norfolk, Conn.

PROBABLY A BULL SNAKE.

A friend describes a snake which he found in the mountains near here, a kind that I have never seen in this country. It was much like the Idaho rattlesnake except that it was longer, slimmer and had a black, sharp pointed spike about $1\frac{1}{2}$ inches long at the end of its tail. It was found among rocks, coiled up, with the spike or tail pointing upward, and was spotted gray in color. Killed and stretched out it measured 52 inches in length. Can you tell me what snake this is and what is its range?

Martin Erickson, Grand Valley, Ida.

ANSWER.

You have given a fairly good description of the bull snake. It has a horn on top of the tail and is known to inhabit Idaho.—EDITOR.

NATURAL HISTORY NOTES.

You ask in RECREATION if anyone knows of another instance where moose have locked horns in fight and consequently died.

On the shores of the Madawaska river, about 3 miles from here, a grand battle took place 8 years ago between 2 moose.

The battleground was on the top of a steep bank, overlooking the river, and when the fight was finished the 2 warriors lay drowned in the water beneath with locked horns. They were found by some of the park rangers who brought the heads and horns in just as they were and had them shipped to Toronto, where they are at present mounted in the Parliament building. R. C. W. Lett, Mowat, Ont.

According to H. P. Gillette, no human eyes have ever seen a bald eagle on Puget sound, an eagle's nest in a fir tree, a tye or steelhead salmon in an eddy or a kingfisher nesting in banks, like bank swallows. The tye and the steelhead salmon are different fishes, *Onchorhynchus chonicha* and

Salmo gairdnerii. All the other things you have probably seen yourself; so why do you let such palpable truths be contradicted?

C. M. J., Portland, Ore.

As I have before stated, I like to give a man a chance occasionally to put his foot in a trap in order to give some other man an opportunity to lambast him as he may deserve.—EDITOR.

I read in RECREATION that permanganate of potash, when used in a hypodermic syringe, was a cure for snake bites. Please tell me what strength to make solution.

C. E. Arnold, Lewisburg, Pa.

ANSWER.

The dose of permanganate of potash is one or 2 grains and it is soluble in 20 parts of cold water or 3 parts of hot water. However, if bitten do not wait for hot water. Inject a cold water solution near the wound. Then dissolve a second grain and inject that. Hypodermic syringes only hold, as a rule, 20 or 30 drops. Thirty drops equals about $\frac{1}{2}$ teaspoonful.—EDITOR.

Can you help me identify a species of bird which I often see here? It is not quite so large as a robin, is plump, has a small head, a short beak, a long forked tail and small, well formed feet. Its back is a dirty gray color, which gets browner near the head, which is a sort of reddish brown. Its breast is buff. It stays around the apple trees and bushes and has a nervous way of shaking itself. J. A. A., Jackson, Mich.

ANSWER.

The bird you describe is probably a female pine grosbeak, *Pinicola enucleator leucura*.—EDITOR.

Regarding locked moose horns: In the fall of 1877 I saw 2 monster pairs locked. The trophy was owned by Colonel Dewitt, a lumberman, of Maine. He told us that one of his men had found them in that position. The horns showed signs of having been in the woods a long time before they were found.

A taxidermist named Miller told me that Mr. Cornell, of St. Johns, who is also a taxidermist, had one or 2 such specimens.

W. S. Crooker, Brookfield, N. S.

RECREATION is the most interesting sportsmen's journal published.

A. H. Mason, Murray Hill, N. J.

RECREATION is a splendid magazine.

C. A. Tubbs, Waukesha, Wis.

THE LEAGUE OF AMERICAN SPORTSMEN.

GENERAL OFFICERS

President, G. O. Shields, 23 W. 24th St., New York.

1st Vice-President, E. T. Seton, 80 West 40th St., New York.

2d Vice-President, W. T. Hornaday, 2969 Decatur Ave., Bedford Park, N. Y.

3d Vice-President, Dr. T. S. Palmer, Dept. of Agriculture, Washington, D. C.

4th Vice-President, A. A. Anderson, 80 West 40th St., New York.

5th Vice-President, Hon. W. A. Richards, General Land Office, Washington, D. C.

Secretary, A. F. Rice, 155 Pennington Ave., Passaic, N. J.

Treasurer, Austin Corbin, of the Corbin Banking Co., 192 Broadway, New York.

LIFE MEMBERS OF THE LEAGUE.

Anderson, A. A., 80 W. 40th St., New York City.

Beard, D. C., 204 Amity St., Flushing, L. I.

Blackstone, Lorenzo, Norwich, Conn.

Buzzacott, Francis F., Chicago, Ill.

Brown, J. Stanford, 489 Fifth Ave., New York City.

Butler, C. E., Jerome, Ariz.

Carey, Hon. H. W., Eastlake, Mich.

Carnegie, Andrew, 2d, Fernandina, Fla.

Carnegie, George, Fernandina, Fla.

Carnegie, Morris, Fernandina, Fla.

Corbin, Austin, 192 Broadway, New York City.

N. T. De Pauw, New Albany, Ind.

Dickinson, E. H., Moosehead Lake, Me.

Edgell, G. S., 192 Broadway, New York City.

Ellis, W. D., 136 W. 72d St., New York City.

Fearing, D. B., Newport, R. I.

Ferry, C. H., 1720 Old Colony Bldg., Chicago, Ill.

Ferry, Mansfield, 183 Lincoln Park Boulevard, Chicago, Ill.

Fraser, A. V., 478 Greenwich St., New York City.

Gilbert, Clinton, 2 Wall St., New York City.

Hudson, E. J., 33 E. 35th St., Bayonne, N. J.

McClure, A. J., 158 State St., Albany, N. Y.

Mershon, W. B., Saginaw, Mich.

Miller, F. G., 108 Clinton St., Defiance, O.

Morton, Hon. Levi P., 681 Fifth Ave., New York City.

Nesbitt, A. G., Maple St., Kingston, Pa.

O'Connor, Col. J. C., 24 E. 33d St., New York City.

Oliver, Rev. F. E., Winfield, Kans.

Pierson, Gen. J. F., 20 W. 52d St., New York City.

Prescott, A. L., 90 W. Broadway, New York City.

Rice, A. F., 155 Pennington Ave., Passaic, N. J.

Rininger, Dr. E. M., 142 E. 27th St., New York City.

Seton, E. T., 80 W. 40th St., New York City.

Seymour, J. H., 35 Wall St., New York City.

Smith, E. B., Bourse Bldg., Philadelphia, Pa.

Smith, W. H., Bryn Mawr, Pa.

Thompson, J. Walter, Times Bldg., New York City.

Towne, E. S., Care of National Blank Book Co., Holyoke, Mass.

Underwood, W. L., 52 Fulton St., Boston, Mass.

Valentine, Dr. W. A., 5 W. 35th St., New York City.

H. Williams, Box 156, Butte, Mont

DISCOUNTS TO LEAGUE MEMBERS.

The following firms have agreed to give members of the L. A. S. a discount of 2

per cent. to 10 per cent. on all goods bought of them. In ordering please give L. A. S. number :

Syracuse Arms Co., Syracuse, N. Y. Guns.

Davenport Fire Arms Co., Norwich, Conn. Shot guns, rifles.

Gundlach Optical Co., Rochester, N. Y. Photographic goods.

Blair Camera Co., Rochester, N. Y. Photographic goods
James Acheson, Talbot St., St. Thomas, Ontario, Sporting goods.

A MESSAGE FROM THE CITY ON THE SOUND.

Speech of the Hon. T. E. Kershaw, delivered at the Annual Meeting of the L. A. S. at Columbus, Ohio.

The Department of Fisheries and Game, which I at present represent in the far-off State of Washington, has, until the last year, been looked on more as a business proposition than from the sportsman's point of view. The office of Fish Commissioner and Game Warden was established in my State 14 years ago, and at that time there were but a few thousand people there, but they were all struggling for commercial supremacy. All the States of the Union were represented by hardy pioneers, who dared to brave the hardships of an undeveloped country for the betterment of their financial condition. These pioneers, many of whom have since attained commercial prominence in the West, were active and alert to their own interests, and thoroughly imbued with patriotism and loyalty to their adopted State; men of keen discernment who saw that the fisheries of the North Pacific could, if properly fostered and protected, be made the leading industry of the State.

Considering that the early development of the West was brought about by true men and women of scant, or at least moderate means, ever having in view the advancement of their own, as well as their State's interest, you can readily see why the Department of Fisheries and Game of the State of Washington has exerted its influence in building up its commercial interests with apparent indifference to the interests of the sportsman.

Our first commercial hatchery was established in 1895, when 5,000,000 young salmon were turned into the Columbia river. From that time on, we have continued to build hatcheries, both on the Columbia and on Puget sound, until to-day we have 18 hatcheries owned and operated by the State of Washington, and since 1895 we have increased the output of salmon fry from 5,000,000 to 84,000,000 in 1902. In addition to this, the Federal Government maintains 2 hatcheries within our State,

making the annual output over 100,000,000 in salmon fry that are liberated from the hatcheries in streams of our State. These salmon fry in a few months find their way to the great ocean, where they mingle with the unknown elements of the Pacific. There they thrive and grow until, in the course of nature, instinct directs them back to the streams from which they descended, to reproduce their kind, when they are interrupted by all the late appliances known to men, and converted into one of the greatest industries of the Pacific coast.

No State in the Union has more varied resources than Washington. Mining is an important industry, yet in 1901 the fishing industry exceeded the mining by \$3,300,000. Notwithstanding we have forests so dense that the sunlight never penetrates them, yet in 1901 the fishing industry of the State of Washington exceeded the lumber output, both foreign and domestic, by over \$1,200,000. In the Eastern part of the State we have the finest wheat farms in the world, yet in 1901 the fishing industry was in excess of our wheat crop in cash value.

When you consider that this fishing industry has been built up in the short space of 9 years from a few thousand dollars to a commercial factor aggregating \$10,000,000 annually, you can easily understand why a conservative Legislature last year voted for the use of my department the liberal appropriation of \$153,000.

The pioneer who blazed his way through the forest, built his log hut on the hillside and cleared his garden spot, has given way to the advance of civilization, and in place of his cabin appear the palatial residence, the undulating waves of cultivated grain. The primitive merchant, with only a few hundred dollars invested in his business, has increased his resources a thousandfold, or given way to greater aggregation of capital. The lonely fisherman who netted or speared fish while his family was warmed by the campfire and sheltered from the storm by the walls of his tepee, has given way by means of modern appliances to large commercial enterprises.

Statisticians will bear me out when I say that no other locality has made such rapid strides in civilization during the past few years as the State of Washington. Within the last decade, we have advanced from a struggling, straggling, impoverished community, without money, developed resources or influence, until to-day our resources are the wonder of the world, and our money finds market in the avenues of the metropolis. We have prestige in every State in the Union, and are recognized as a factor in both the political and the commercial world. Our citizens are fast reaching that financial condition where they can share with

their Eastern neighbors the joys and pleasures of outdoor life.

About 2 years ago, when I took charge of the Department of Fisheries and Game, my attention was first called to the rapid inroads being made on our game, and the depletion of our mountain streams of their finny tribes. The great prosperity of our State during the last few years has brought within her borders men of wealth, men of leisure, men who do not view life entirely from a commercial standpoint; men who believe the serious side of life should be brightened by outdoor sports; men to whom the whisp of a fish and the ripple of water are as music; to whom wild game in the forest, the majestic trees, the placid lakes and the babbling brook in which fish abound, appeal in all their grandeur and beauty.

As we looked with pride on this great influx of wealth, prosperity and civilization within our State, we yet realized, with misgivings, that it would be the cause of the disappearance of the rainbow and the cut-throat from our mountain streams, and the deer and the elk from our wooded hills. We realized that if our game was not to become extinct within a few years, heroic measures must be adopted, and this led to a conference between a few true sportsmen of the West and myself. The result was that last year we placed a code of laws on our statute books for the preservation of our game; and, while they are not perfect nor so radical as we would have them, still they work well for a beginning, and we expect within a few years to make the State of Washington one of the grandest game preserves on this continent.

The law prohibits the killing at any time of any spotted fawn, or more than 4 deer during the season when it is lawful to kill the same. It prohibits the killing at any time of any female elk, moose, antelope, mountain sheep or goat, and, during the season when it is lawful to kill any of these animals, only one male of each species may be killed. No person shall, during the season when it is lawful to hunt, kill more than 10 prairie chickens, 10 grouse, sage hens, native pheasants, ptarmigan, Chinese or Mongolian pheasants, nor more than 15 quail of any variety, 25 snipe, ducks, geese or brant, in one day.

Deer must not be run with dogs nor fire-hunted; ducks and geese shall not be hunted from launches nor sink boxes.

This is the general law, but in many counties some of the game is entirely protected until 1906 and 1908. The sale of all game is prohibited except during November of each year, when ducks, geese, brant and snipe may be sold to the number permitted to be killed in any one day. Hotel keepers, boarding houses, markets,

cold storage houses, etc., are prohibited from offering for sale or keeping, or having in their possession any of the aforementioned game, except geese, brant, ducks and snipe during November. Transportation companies are prohibited from transporting any of the aforementioned game into, out of, or through our State, and the same law applies to all of our game fishes. Fishes in certain lakes are protected until the year 1908. Song birds and their nests are also protected.

Every person who hunts in the State of Washington during the season when it is lawful to hunt, must first procure a license from the county auditor in the county in which he wishes to hunt, and if he desires to hunt in more than one county, he must obtain a license in each county in which he hunts. The annual license fee is \$1, and there is no discrimination between resident and non-resident applicants. The fee is placed in the hands of the County Treasurer, goes into the game protection fund, and is used for the purpose of employing county game wardens. In any case where the county commissioners fail to appoint a game warden, the State game warden has the right to appoint one.

I have, during the past year, corresponded with or personally seen the Board of County Commissioners in most of the counties of my State, and urged the necessity of building up our game preserves.

This year I am building the first trout hatchery in our State. It is located on the beautiful Lake Chelan, far up in the Cascade mountains, and is an ideal spot for the enterprise as well as a pleasant resort for the tourist. The hatchery will be modern in all its details, and will be supplied with a complete system of ponds and basins for rearing all the choice varieties of game fishes. At the convening of the next Legislature I shall ask for an appropriation for the construction of 2 more game fish hatcheries. One will probably be located in the prairie country, on the Little Spokane river, about 9 miles from Spokane, in the Eastern part of our State. The other will probably be located in the Western part of the State, on Lake Crescent, a most picturesque body of water high up in the Olympic range, and one of the most beautiful places known to man. These hatcheries will likewise be modern in all their equipments, and when completed and in operation, my State will be as well equipped for supplying our streams and lakes with game fishes as any States in the Union.

Before I return home, there is one matter to which I wish to call your attention. In 1905, the Lewis and Clarke Exposition will be held in Portland, Oregon, just across the Columbia river from the borders of my State, and a few hours' ride from

the beautiful city of Seattle. Transportation will be furnished so cheaply as to induce visitors to attend the exhibition from the remotest corners of the continent. At a meeting of the Game Protective Association of my State, which I attended at Seattle a few days before leaving home, it was unanimously decided to use all honorable means to induce this association to hold its Seventh annual convention in Seattle, during the summer of 1905. If you accept our invitation we promise you a hearty welcome. You will meet, on the shores of the Pacific, a whole souled class of people; men who have had the courage to leave the luxuries of life behind them and by their energy and enterprise help to raise an empire out of the wilderness of the West. You will meet men who are building up the great West, generous men, courageous, enterprising, broad minded men, true and brave, who know what is right and who dare to do it. We will show you the great wheat farms of our State, the home of the grouse and the prairie hen. We will show you the mighty rivers of the West, the Columbia and the Fraser; the spawning grounds of the Chinook and the sock-eye; the magic cities of the West that are the wonder of the commercial world; the grandest mountains in the world, enclosing the most beautiful inland lakes. We will show you the wooded hills, the range of the deer and the elk, and will let you listen to the sweet music of our mountain streams, the paradise of the rainbow, the Mediterranean of the West, and will let you breathe the pure air from the placid Pacific. We will show you the eternal snow-capped peaks of Mt. Tacoma, Mt. Baker and Mt. Hood, standing as sentinel guards over this great empire of the West.

You can gaze on mountain streams and cataracts tossing their spray far into the heavens, glistening in the rays of the sun with prismatic tints that would cause the rainbow in all her glory to blush with shame. You can see the threatening smoke ascending skyward from volcanic eruptions, and then turn your vision to the peaceful harbors of the Pacific, and behold the great ocean steamers rocking as quietly to their anchors as sleeping babes in their cradles. We will show you on our benchlands the finest timber in the world, gigantic trees of fir, hemlock, cedar and spruce, measuring 14 feet in diameter, and climbing heavenward 200 feet before shooting forth their first limbs. We will show you valleys of wild flowers, sending forth such fragrance and perfume as to discourage all the sweets of Arabia, and which will give you eternal dreams of paradise; we will dine and wine you to the queen's taste, and will entertain you with songs and stories by the most beautiful women on earth.

Edited by C. F. LANGWORTHY, PH.D.

Author of "On Citraconic, Itaconic and Mesaconic Acids," "Fish as Food," etc.

"What a Man Eats He Is."

THE IMPORTANCE OF POULTRY.

Poultry of various kinds has for many centuries supplied a large proportion of the food of civilized man, and in almost every country of the world the poultry industry is an important branch of agriculture. According to the returns of the census for 1900 the total number of chickens, including guinea fowls, on farms in the United States was 233,598,085; the total number of turkeys, 6,599,367; geese, 5,676,863; and ducks, 4,807,358. From the statistics gathered it appeared that poultry was kept on 88.8 per cent of the farms in this country and that the total value of the poultry raised on farms in 1899 was \$136,891,877. Although many of the hens and chickens are bred for their eggs rather than their flesh, a good proportion of the birds finally appear in the meat market and almost all the other varieties of poultry are bred primarily for the table. It is safe to say that 125,000,000 chickens and other kinds of poultry are consumed in this country each year.

In its strictly technical sense the word poultry is used to describe birds domesticated for their eggs or flesh. Game birds, that is, wild birds killed for sport or food, are often used on the table and, as in the case of some wild ducks, may be closely related to domestic varieties; but as long as they are in their wild state they can not be classed with poultry. Not all domesticated birds are necessarily poultry. Pigeons bred for ornament or as carriers would not come under that head although they do belong there when bred for their flesh. Pea fowls were formerly often bred for the table and were an important variety of poultry, but now they are bred mainly for ornament, and form only an almost negligible part of the poultry industry.

Thus the kinds of birds included under the term poultry may differ in different places and at different times. Here and in Europe, however, it now commonly includes common fowls, or chickens, turkeys, geese, ducks, guinea fowls, pigeons and, less commonly, pea fowls, pheasants and swans.

Ducks, geese and swans belong to the order *Natatores*, or swimmers, characterized by their web feet and long thick bills. Chickens, turkeys, guineafowls, peafowls and pheasants belong to the same scientific order of birds, the *Gallinacea*, or comb bearers, and resemble one another more

or less closely in structure and habits. They are distinguished from other birds in that the flesh on the breast and wings is lighter in color than on the rest of the body. This difference in the flesh in different parts of the birds is not fully understood; it is generally supposed that the light flesh has less muscular power; at any rate those birds, whose chief means of locomotion is walking and who consequently do not need as strong wings and breasts as flying or swimming birds, have paler breast and wing flesh. The difference in color is apparently due to variations in the quantity of hemoglobin (the principal red substance of blood) present in the flesh. Investigations carried on in France a number of years ago showed that the red color was a product of muscular activity. In other words when muscles work as actively as those of the breast of flying birds, hemoglobin is produced.

Geese have been known as table birds at least since the days of Ancient Egypt. In all probability, chickens were domesticated in Burmah, in early times, from the jungle fowl, native in Southwestern Asia and Oceanica. No one knows when they were first tamed by man, but they were surely used in China in 800 B. C., if not earlier. The ancient Babylonian monuments mention them, and it was probably from Persia that they were introduced into Greece at the time of Alexander the Great. Since then they have spread all over the world in the track of European settlement.

As regards the size of chickens for table birds, the live weight of standard bred cocks ranges from 10 to 12 pounds, hens from 7 to 9.5, cockerels from 8 to 10 pounds, pullets from 6 to 8 pounds and broilers about 2.5 pounds. A good table bird should have a large proportion of flesh to the size of its bones, and a large, full breast, on which is found the delicate white meat. Long, thin legs and wings are undesirable, as they contain much bone and little meat. In England dark legged chickens are considered better than those which have legs and body of the same color, but in this country the preference is for the latter, though the reason for either choice is not clear. Light colored birds perhaps pluck cleaner than dark ones and are easier to make attractive for the market, which demands a skin free from visible pin feathers. Almost any of the stan-

dard breeds, except some of the fancy varieties, can be made into good table birds. However, some of this class, notably games, are thought especially desirable for the table.

THE VALUE OF OATMEAL AS FOOD.

An English physician recently asserted in the London Daily Mail that instead of being a wholesome and nutritious food oatmeal porridge is rapidly attaining the proportions of a national curse.

According to the New York Times, "This characterization of a food staple which has attained a recognized place in the contemporaneous dietary, as a curse from any point of view, would seem to involve some exaggeration. Very likely more has been claimed for porridge as the equivalent of beef than its real value for dietetic purposes would warrant, but it undoubtedly has its place in the domestic economy, and has become important. It seems to be the one breakfast cereal which wears well, and while perhaps too hearty for large consumption in summer, it could not well be spared as a food for either horses or men."

That the view expressed by the writer in the Daily Mail is not shared by all who have studied the problem is shown by the fact that one of the best known authorities on dietetics in Scotland attributes the poor condition of many laborers' families at the present time to the substitution of bread and tea for the old fashioned oatmeal porridge and milk diet. Unsanitary surroundings and poverty, so great that it prevents the use of meat and other foods with porridge or bread, are factors which must be considered in discussing at all accurately the bad health noticed among the poor in Scotland.

The truth of the matter is that both bread and oatmeal are good foods when well prepared and reasonably used. Oatmeal is a starchy food and should not be overloaded with sugar when eaten, a custom which is responsible for much of the indigestion attributed by many Americans to its use. Milk contains considerable nitrogenous material and may appropriately accompany oatmeal; these 2 foods in combination being probably more nutritious than bread and tea if the diet were to be limited practically to either of these combinations. It is important that oatmeal should be thoroughly cooked at a temperature high enough to insure the proper changes in the starch molecule. Oatmeal, such as we are all familiar with, cooked so that it is more like a poultice than a food, is enough to bring any article of diet into disrepute. Well cooked and eaten without too much sugar, oatmeal is undoubtedly a wholesome food of about the same nutritive value as wheat bread.

TILES IN GERMAN MEAT SHOPS.

Perfect cleanliness in handling food products should be insisted on by purchasers. The use of tiles, marble and metal, which may be easily cleaned, in place of wood, in fitting up markets, etc., is growing and should be encouraged. Apparently more attention is paid to such matters in Europe than in this country and many will recall the attractive shops in Paris and other continental cities, for the sale of bread, cooked meat, and other provisions.

On this subject the American Consul at Manheim, Germany, writes as follows: "Americans visiting Manheim frequently comment on the attractive meat shops to be seen here. This attractiveness is secured largely by the use of ornamental tiles for floors, walls and even ceilings and counters. The tiles on the walls are similar to those used in bathrooms in the United States. They are generally of light shades, arranged in patterns of artistic design. The floors are also laid with tiles of different colors. These tiles, however, are unglazed and are heavier and of cheaper quality than those on the walls.

"In one of the most attractive of these stores, the walls are of ivory-colored tiles, with panels of flowers and other designs. The counter, which runs along 2 sides of the room, is of the same ivory-colored material, ornamented in gold. It presents a rich, handsome appearance. Even the bookholders, scales, and gas fixtures are tiled. The general effect of the room is suggestive, above all, of cleanliness.

"Stoneware furniture for stores is a novelty in Germany and seems to be applicable especially to meat shops, fish and other markets, kitchens, sculleries, etc. The most important center for its manufacture in this country is Mettlach, where there are several large factories."

A lawyer had as client a negro who was accused of stealing chickens. Things were going in the darkey's favor, until he was placed on the stand.

"Are you the defendant in this case?" asked the judge.

"No, sir," replied the negro, with an amazed look on his face, and pointing to his counsel; "I'se the gen'leman that stole the chickens; there's the defendant."—Argonaut.

"Mr. Mills," said the spokesman of the workingmen's committee, "we have come to tell you, sir, that we want shorter hours and——"

"Very well," interrupted the busy manufacturer, "we'll begin right off with shorter dinner hours."—Exchange.

PUBLISHER'S NOTES.

BEST VALUE FOR LEAST MONEY.

A question which every household considers at some time or other is how to get the best piano possible at the lowest possible price. It is well known that the profits on pianos sold in retail stores or by piano dealers are very large, usually not less than \$75 or \$100, and often as much as \$250.

To enable buyers to save this amount, Wing & Son, a firm of piano manufacturers in New York, make a specialty of selling their pianos direct from their factory at wholesale price. They do not supply their pianos to dealers or retail stores, and do not employ salesmen or agents. Their factory and offices are at 9th Ave., corner of 13th St., New York City, and are among the oldest in the United States, having been established over 36 years ago. In that time Messrs. Wing & Son have manufactured and sold over 38,000 pianos. Their catalogue contains thousands of testimonials. They also publish a Book of Information About Pianos, which they state contains as much information as is possessed by the most experienced piano expert, and which is therefore of great value to any one wishing to buy a piano. They send it free to any one who will write them and mention RECREATION.

Address, Wing & Son, Wing Building, 9th Ave., corner 13th St., New York City.

These are the days when sportsmen's wants are supplied before they really exist. For years there have been tin tackle boxes on the market that seemed to answer every purpose, but now the Merriam Mfg. Co., of Durham, Conn., has put out a new one that makes the old ones look like 2 bits and a nickel. This new box has the call on the others for the reason that there are no trays in it to be lifted out and in and packed from time to time. All the interior space of the box can be utilized for tackle of various kinds, and when through assorting and placing the goods you simply shut down a trap door, close the lid of the box, lock it and there you are. Everything is securely held in place and when wanted any article in the box can be reached in an instant.

This new contrivance is fully described and illustrated in a circular issued by the Merriam Mfg. Co., and every angler in the land should have a copy of it. In writing for it please mention RECREATION.

Bird, Jones & Kenyon have devised and

are making a hunting coat that is a decided improvement on anything of the kind I have ever seen. It is made of brown duck canvas, of various shades, which is treated by a chemical process that renders it entirely waterproof and that at the same time leaves the cloth soft and pliable. The trouble with such goods heretofore has been that the waterproofing process has made them stiff and noisy when worn in the woods. This new process duck is almost as flexible and pleasant to the touch as buckskin, yet is absolutely waterproof.

The coat is known as the Duxbak, because it sheds water like that well known watershed.

Write for a circular and a sample of the cloth, and be sure to mention RECREATION.

The Blair Camera Co. has issued a beautiful little book describing and illustrating certain new features in cameras, shutters, etc., which this house is putting out. The book is full of valuable information and the cuts are of so high an order that they show you exactly what each camera is. Full details are given as to prices of all cameras and the various other goods which the Hawk-Eye people supply. Write for a copy of the book and please mention RECREATION.

The Ithaca Gun Co., which has been conducted as a copartnership for the past 22 years, has recently incorporated under the laws of the State of New York. The officers are Geo. Livermore, Pres.; L. P. Smith, Vice-Pres.; C. H. Smith, Sec.; Paul Smith Livermore, Treas. The management remains unchanged and the incorporation is the result of an increase in business from year to year until the Ithaca Gun Co. became too large to be run under a copartnership.

Readers of RECREATION are cautioned against doing business with Henry Flohr, who claims to be a representative of RECREATION. He is a swindler and should be arrested and locked up wherever found. He has taken a number of subscriptions to RECREATION, and has failed to send in any of the money collected for them.

The Sunny South Handicap Amateur Average was won by M. E. Atchison with his Parker gun.

EDITOR'S CORNER.

The Tacoma, Washington, Lodge of Elks has passed a resolution which, after reciting the reckless and wicked slaughter of elk in the Olympic mountains for their teeth, declares that the members of the Tacoma lodge will not buy nor wear elk teeth in future, unless they can be assured that elk are not being killed for the purpose of procuring such teeth.

The resolution also advises other lodges of Elks throughout the country to take similar action. It is high time all members of that order should take this important step. The real badge of the Order of Elks is a gold or bronze elk head, and the wearing of elk teeth is a custom which certain members of the order have copied from sportsmen. Many a man who hunts and kills an elk feels inclined to wear one of its teeth on his watch chain; but a man who has never hunted elk and who simply happens to belong to an organization named after that animal has no excuse for wearing a tooth or any other part of an elk. Furthermore, it seems ridiculous that any organization should contribute so largely as this one has to the extermination of the animal for which it is named.

Two Chicago game hogs, whose names, unfortunately, I have not been able to learn, went to Arkansas last fall to shoot ducks. They openly disregarded the game law of that State, one section of which provides that no non-resident of the State shall be allowed to hunt therein at any time. These Chicago chaps, however, seemed to imagine they would not be disturbed in violating the law. They reckoned without their host. When the men returned to Forest City from their 2 weeks' trip to De Roach lake they had with them over 500 ducks. Sheriff J. D. McKnight, of St. Francis county, confiscated the birds and strangely enough allowed the men to leave town on the next train without being prosecuted. They should have been fined to the full extent of the law, but they probably got a lesson that will keep them out of Arkansas in the future.

The Manitoba Legislature has passed the League bill prohibiting the use of the automatic gun in that Province. This is the first legislative body in the world to take such action. Manitoba is one of the most important game bird Provinces in Canada. Its vast wheat fields are the breeding and feeding grounds of more prairie chickens

than can be found in any other Province, or in any State of the Union, and the Northern portions of that Province are great breeding grounds for ducks and geese. It is gratifying to know that the law makers of Manitoba have a proper appreciation of the value of these birds, and that they should have been the leaders in the movement against this modern slaughtering machine.

Leon Kurtes, of Bellville, Ill., saw a deer in the woods near his father's house and immediately seized his gun, went after it and killed it. It proved to be a doe and to have belonged to little Mamie Bauer, the daughter of a man living a few miles from Kurtes, and it had a string of bells around its neck. Kurtes was arrested, taken into court, and fined \$50 and costs. The boy said he did not know the deer was a pet, and that he did not know there was any law in Illinois to prohibit the killing of deer. He said he saw the animal and was seized with a desire to bring down his first pair of antlers, but he probably mistook the string of bells for horns. He will be able to judge better of markings hereafter.

Gus Ottevere, of Whatcom, Wash., has been for some time smuggling game into that town and selling it to restaurants in violation of law. Game Warden F. D. Adams got a tip that Ottevere was returning from one of his rural tours with a number of ruffed grouse concealed in a nail keg. The warden laid for Smart Aleck Ottevere, caught him and took him into the justice's court, where he was fined \$100 and costs. I regret I have not the name of the justice who tried the case, in order that I might do him proper honor; but whoever he may be, he is a brick.

A bill was introduced in the New Jersey Legislature last winter, at the instance of certain fruit growers, allowing the killing of robins whenever, in the opinion of a farmer or a fruit grower, the birds deserved killing; but the Senate killed the bill by a vote of 46 to 8. The Senate is all right.

Otto Hofstead, of Butte, Mont., was arrested and fined \$25 and costs for merely offering venison for sale. It would not pay him to make many such offers as this in a day.

Write for FREE SAMPLE

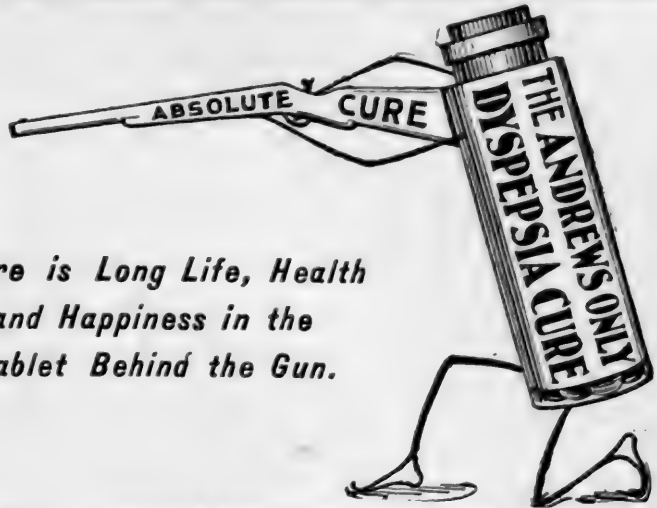

There is Long Life, Health
and Happiness in the
Tablet Behind the Gun.

FOR IMMEDIATE AND PERMANENT RELIEF USE

The Andrews Only Dyspepsia Cure

The day you begin using it

YOU CAN EAT ANYTHING YOU LIKE AND ALL YOU LIKE,

as it will both **CURE** and **PREVENT** every form of indigestion or stomach trouble, and correct all ailments incident to Dyspepsia. **GUARANTEED TO CURE OR MONEY RETURNED.**

Not a patent medicine but a secret compound of genuine remedies, endorsed by physicians. Contains nothing harmful in any respect, and

IT WILL CURE. This medicine has been used in parts of New England for 15 years and has never failed to give immediate relief in any case of Dyspepsia, and it will cure all ailments arising from indigestion, and so build up and strengthen one's system as to help it naturally in throwing off any ailment other than those arising from Dyspepsia.

As a Safeguard against impairing one's digestive organs, and for preventing ill effects of all sorts, every person, (ill or well,) should take one of these tablets after heavy eating or drinking, particularly if the food eaten is of an indigestible nature, or if eaten at night.

It does not partly digest food like pepsin, but acts directly upon the stomach, strengthening and regulating it so that it is able to perform its natural functions and correct all sorts of troubles that are incident to indigestion.

GUARANTEED to cure all forms of Dyspepsia or money returned.

DIRECTIONS—For any form of Dyspepsia, Sour or Acid Stomach, Heartburn, Gastritis, Canker, Nausea, Sleeplessness, Bowel Troubles or anything arising from indigestion, chew up and swallow one tablet after each meal, or at any time when needed. Tablets do not contain opiates or narcotics or anything harmful, and dose will not have to be increased after one has used it awhile.

PRICE, 25c postpaid.

As few druggists yet keep it, or know of it, we will supply it by mail on receipt of price.

Address all orders, etc., to the
ABSOLUTE REMEDY COMPANY

HON. J. LEWIS CHILDS, Pres.
HON. CLARENCE LEXOW, Vice Pres.
H. H. DAVIES, Sec'y and Treas.

Floral Park
New York

SAMPLE FREE.—We will mail FREE a sample of this wonderful remedy if you mention RECREATION. Try it and be convinced of its value. Write a postal card today for it.

Unsolicited Testimonials

DR. CHAS. W. TAYLOR, Lowell, Mass., says: "I have used 'The Andrews Only Dyspepsia Cure' in my private practice, and it has cured when all other remedies failed."

Dr. Taylor is a graduate of Harvard Medical School, late Medical Examiner of Mass. Medical Society, and Physician of Mass. General Hospital, and City Hospital of Lowell.

DR. H. B. EATON, 23 Oak St., Rockland, Me., says: "I have used your Dyspepsia Cure in my practice for the past five years. I use it for Sour Stomach, Heartburn and Water Brash, also spitting food after eating, and distress with pain and nausea. I find that it works very quickly."

MR. CHAS. L. FLINT, of Standard Oil Co., East Cambridge, Mass., says: "Dr. Chas. F. Roberts has recommended to me 'The Andrews Only Dyspepsia Cure,' and I herewith enclose an order for it."

FRANK MELVILLE, 138 E. 14th St., N. Y. City, says: "Having used one box of 'Andrews Only Dyspepsia Cure,' I can with pleasure say that I have been greatly relieved from a case of Dyspepsia and Sour Stomach of several years' standing. Your remedy is indeed a great one."

REV. CHAS. H. HICKOK, Dept. Chaplain G. A. R., Wakefield, Mass., says: "For more than 30 years I have been troubled with Dyspepsia in its most acute forms, accompanied by Nausea, Water Brash, Heartburn, Acidity of stomach, and all its attendant evils. All remedies would only give temporary relief. Three months ago I tried 'The Andrews Only,' which worked like a charm. It has relieved me very largely from all suffering, having only occasional attacks of brief duration, and feel that in the end it will cure me entirely. I heartily recommend your cure."

G. L. GIBBS, Concord, N. H., says: "I have been troubled very much with dyspepsia and weak stomach, and was not able to eat anything hearty without distress. By using your Dyspepsia Cure I can now eat anything."

HON. W. H. I. HAYES, Lowell, Mass., says: (Mr. Hayes is serving his 14th term in the Mass. Legislature.) "I use your remedy and write that people who suffer from indigestion may know that there is a cure. I carry the 'Andrews Only Dyspepsia Cure' in one pocket, my watch in the other. I can live without the watch, but not without the Cure."

MRS. C. A. VUSLER, Delaware, N. J., writes: "I received the tablets of 'Andrews Only Dyspepsia Cure.' It was really a godsend to me. I never had anything give me such relief in so short a time. I enclose one dollar for more."

AN UNEXPLORED ALASKAN REGION.

E. K. HILL.

In the exploitation of Alaska and its gold fields, it seems strange that the world has overlooked a section of that country destined, I think, to become a center of attraction to the gold hunter, and to the tourist.

In the summer of '06, seeking a respite from the drudgery of teaching, I planned a vacation trip Northward from Seattle, Washington. In company with Professor Bailey and other teachers I found my way to the strawberry carpeted sand beaches of Yakutat bay.

To stretch one's self on the mossy mounds; to bask in the sunshine; to look up to the still, white summits of the lofty St. Elias range: that was sufficient relaxation for a tired schoolmaster.

But we were there for exploration as well as for rest. With boats and camping outfit, we were soon venturing out on Disenchantment bay, which forces its sinuous length 40 miles into the heart of the loftiest and grandest range in North America. No one can describe the impression produced by that culmination of Arctic grandeur and desolation. The spruce forests shrink back as if in horror at the life-destroying breath of stupendous glacial torrents which, with constant thunder, pour into the troubled waters of the bay.

After camping along the beach, rowing amid the icebergs, exploring the dead glaciers and the accessible mountain slopes, for a few weeks, we determined to seek a passage Eastward to the Alsek river. Jack Dalton had come over from the White river and passed down the East branch of the Alsek to the coast, some years before; but neither white man nor native had explored the West branch, arising North of Mt. St. Elias. After trying several impassable dead glaciers, both with packs and with sled, and spending a month floundering in the snow among high peaks and ridges, we finally discovered a low pass. Through it we drew a large load over to the river in 4 days, and returned in 3. When snow is on the ice, from January to June, the passage is easy, even with a large load on your sled. There is no steep climbing and no narrow gorge.

The river country abounds in game. I killed 2 bear the first day after reaching timber and saw tracks of many other fur and game animals.

The West branch of the Alsek is a large stream, and will probably furnish an easy passage to its head waters. Thence it is but a short distance to the tributaries of the White, the Tanana and the Copper rivers.

It would seem that the Northeast side of the St. Elias range should be a rich field for the prospector. I shall guide a party into that country in the early spring.

AN OCULAR DEMONSTRATION.

M. WHITFIELD.

"Yes," said the old man with the glass eye, as he removed that vitreous substitute from its usual place and carefully polished it with a ragged handkerchief—"yes, its likely I've had more surprisin' adventures than any o' you fellers." The loungers in the village store winked at one another, and the old man continued:

"Once while I wuz a herdin' sheep up in Judith Basin, I went out with my old 8-bore to see if I could get a shot at a coyote that had been killin' my lambs. As I turned a bend in a coulee on my way back to camp, thar sat an old black bear not 10 yards ahead of me. Soon's my hair had laid sufficient, I backed off a few steps an' blazed away. The b'ar stood a minute as if he'd forgot sunthin, then started off through the sage brush like he wuz goin' to hunt fer it.

"Meantime I rammed a load of powder into th' old gun an' wuz a-feelin' fer my buck shot when Mr. B'ar come out o' th' brush a-pintin' right my way. I see he wuz somewhat riled, an' not wishin' to have no fuss with him I lit fer th' nighest tree. Mr. B'ar made fer th' same one. I managed to git up it fust, though none too soon, fer th' b'ar wan't move'n a len'th behind. I wound one leg around a limb an' fired that load o' powder right in his face. At that, he slid down th' tree and went to pawin' dirt an' sneezin. I loaded with powder ag'in the best I could under th' circumstances, but when I felt fer my shot pouch, I found I'd lost it while makin' fer th' tree.

"Well, th' b'ar kep' a gittin' madder all th' time an' wuz comin' up th' tree again. Th' hair wuz all burned off his head whar I'd shot th' powder in his face an' it made him look like one o' them 'Gyptian mummies, but he want nigh so dead!

I drewed my legs up as far as I could an' wuz a-tryin' to think of a prayer, when all to once this old glass eye o' mine begun to twitch. Quicker'n it takes to tell it, I out with it, rammed it into th' old gun an' took a snap shot at th' b'ar just as he wuz pullin' off one o' my boots. Down he went all in a heap an' he laid so durn still I thought mebbe he wuz a-playin' possum on me, an' I sot right where I wuz fer some little time. Finally, I clim down out of th' tree an' took a circle around the b'ar, an' I'll treat the house if I didn't catch sight of the old glass eye just as it winked at me. It had gone through the b'ar and jest pricked through the skin on the other side. This is th' same old eye, an' a fine time I had rubbin the powder marks off'n it."

A woman may think her husband a failure, but marriage; never.

THE EQUITABLE



J.W. ALEXANDER
PRESIDENT

J.H. HYDE
VICE PRESIDENT

HENRY B. HYDE
FOUNDER

LIKE A RAINBOW

in its assurance for
the future is an adequate
Endowment Policy in the
Equitable.

It assures your own
future—and the future of
your family.

Opportunities for men of character to act as representatives
Apply to GAGE E. TARBELL, 2nd. Vice President

For full information fill out this coupon, or write

The Equitable Life Assurance Society of the United States, 120 Broadway, New York
Dept. No. 16

Please send me information regarding an Endowment for \$.....if issued at.....years of age.

Name.....

Address.....

AMATEUR PHOTOGRAPHY.

"For sport the lens is better than the gun."

I wish to make this department of the utmost use to amateurs. I shall, therefore, be glad to answer any questions and to print any items sent me by practical amateurs relating to their experience in photography.

THE ANNUAL COMPETITION

RECREATION has conducted 8 amateur photographic competitions, all of which have been eminently successful. The 9th opens April 1st, 1904, and will close November 30th, 1904.

Following is a list of prizes to be awarded:

First prize: A Long Focus Korona Camera, 5 x 7, made by the Gundlach Optical Co., Rochester, N. Y., fitted with a Turner-Reich Anastigmat Lens, and listed at \$85.

Second prize: A 4 x 5 Petite Century Camera, with Goerz Anastigmat Lens and Century Shutter, listed at \$73.

Third prize: A Royal Anastigmat Lens, 4 x 5, made by the Rochester Lens Co., Rochester, N. Y.; listed at \$36.

Fourth prize: A Waterproof Wall Tent, 12 x 16, made by Abercrombie & Fitch, New York, and listed at \$32.

Fifth prize: An Al-Vista-Panoramic Camera, made by the Multiscope and Film Co., Burlington, Wis., and listed at \$30.

Sixth prize: A No. 3 Focusing Weno Hawkeye Camera, made by the Blair Camera Co., Rochester, N. Y., and listed at \$27.50.

Seventh prize: A 12 x 12 Waterproof Wall Tent, listed at \$16.30.

Eighth prize: A Tourist Hawkeye Camera, 4 x 5, and made by the Blair Camera Co., Rochester, N. Y., and listed at \$15.

Ninth prize: A Bristol Steel Fishing Rod, made by the Horton Mfg. Co., Bristol, Conn., and listed at \$8.

Tenth prize: A pair of High Grade Skates, made by Barney & Berry, Springfield, Mass., and listed at \$6.

The 10 next best pictures will each be awarded a pair of chrome tanned leather driving or hunting gloves made by the Luther Glove Co., and listed at \$1.50.

The 10 next best pictures will each be awarded a Laughlin Fountain Pen, listed at \$1.

A special prize: A Goerz Binocular Field Glass, listed at \$74.25, will be given for the best picture of a live wild animal.

Subjects are limited to wild animals, birds, fishes, camp scenes, and to figures or groups of persons, or animals, representing in a truthful manner shooting, fishing, amateur photography, bicycling, sailing or other form of outdoor or indoor sport or recreation. Awards to be made by 3 judges, none of whom shall be competitors.

Conditions: Contestants must submit 2 mounted prints, either silver, bromide, platinum or carbon, of each subject, which, as well as the negative, shall become the property of RECREATION. Negatives not to be sent unless called for.

In submitting pictures, please write simply your full name and address on the back of each, and number such prints as you may send, 1, 2, 3, etc. Then in a letter ad-

ressed Photographic Editor, RECREATION, say, for instance:

No. 1 is entitled — — —.

Made with a — — — camera.

— — — lens.

On a — — — plate.

Printed on — — — paper.

Length of exposure, — — —.

Then add any further information you may deem of interest to the judges, or to other amateur photographers. Same as to Nos. 2, 3, etc.

This is necessary in order to save postage. In all cases where more than the name and address of the sender and serial number of picture are written on the back of prints I am required to pay letter postage here. I have paid as high as \$2.50 on a single package of a dozen pictures, in addition to that prepaid by the sender, on account of too much writing on the prints.

Any number of subjects may be submitted.

Pictures that may have been published elsewhere, or that may have been entered in any other competition, not available. No entry fee charged.

Don't let people who pose for you look at the camera. Occupy them in some other way. Many otherwise fine pictures have failed to win in the former competitions because the makers did not heed this warning.

IMPROVING NEGATIVES.

III.

Faulty negatives may be much improved by a judicious choice of printing paper, but some negatives fail to give satisfactory prints, even when used with what is apparently the correct paper. Often these may be modified and improved in other ways. Take, for instance, an over exposed negative. It is full of detail but thin. The sky prints a dirty gray and there are no high lights. Although a slow printing paper like carbon velox, or even slow cyco, gives a fair print, a vastly better one can be made by intensifying the negative. This is a simple operation and the newest recruit in the art need not hesitate to try it. There are various formulæ for intensification, but probably the one most used is that which employs bichloride of mercury as the active agent. Intensification by this method consists in first bleaching the negative in a solution of bichloride of mercury and then blackening it in a weak solution of sodium sulphite or ammonia.

To prepare the bleaching solution, take 4 ounces of water and to it add 40 grains each of bichloride of mercury (corrosive sublimate) and ammonium chloride (sal ammoniac). While these are dissolving, which takes some time with the bichloride, put the negative to soak in a tray of cold

water, as it is important to free it from hypo before attempting to intensify it. Let it wash for half an hour, by which time the bleaching solution will have dissolved ready for use. Place the negative in this solution, and it will at once begin to turn milky white.

Leave it in the solution until it is white clear through to the back. There is no danger of overdoing this part of the operation, and a few minutes more or less will make little difference in the result. When the plate is thoroughly bleached pour off the bleaching solution and keep it for future use. Wash the bleached negative thoroughly for half an hour at least, and in the meantime make up a solution of sodium sulphite, about 20 grains to an ounce of water. Having given the bleached negative a thorough washing, place it in the sulphite solution, and it will immediately begin to turn brownish black. As soon as the blackening process is complete pour off the soda solution and give the negative another half hour's wash. The whole negative will have become thicker and the color changed to a warm brown black, and the negative will print much slower than before. The print will show decidedly more snap and contrast than those previously made. The whole process may be repeated if the first trial fails to give satisfactory results, always being careful to give the negative a thorough washing between the operations.

There are other methods of intensification which may easily be tried, but the foregoing is probably as satisfactory as any for the amateur. Intensification is of value only when there is detail in the negative to work on. On under exposed negatives which are thin but which lack detail in the shadows it is disappointing, for it only adds contrast, but can not bring out detail which does not exist. It really makes the negative worse instead of showing improvement. It is almost impossible to make any improvement in badly under exposed negatives, and the best course is to throw them away.

For negatives which are thin from over exposure simple intensification is probably the best means of improvement. Some over exposed negatives, in which development has been prolonged in the attempt to gain contrast, are thick and heavy looking, slow in printing, and yield flat, washed out prints. On these it is best to perform a sort of compound operation, first removing some of the extra density with a suitable reducing agent, and then, if the prints still lack contrast, intensifying the negative as previously described.

As with intensification there are various methods for reducing a negative, but the best one is that known as Farmer's method,

which makes use of a solution of red prussiate of potash and hypo. To prepare it weigh out $\frac{1}{4}$ ounce of hypo and dissolve it in 4 ounces of water. In another bottle or graduate dissolve ferricyanide of potash (red prussiate of potash), 40 grains in one ounce of water. This should be done in a weak light, as light causes a chemical change to take place in the ferricyanide. For the same reason the operation of reducing should be performed in a dim light.

To use the solution, add a few drops of the ferricyanide solution to the hypo and pour it over the negative, which has previously been well soaked to soften the film. It is advisable to give the negative this preliminary soaking before subjecting it to the action of any chemical solution, in order that the action of the solution may be uniform. The negative should be watched closely, and if it does not begin to lose density in a few minutes, add a few more drops of the ferricyanide solution, the rapidity of action depending on the quantity of this chemical in the solution. It is better to use a rather weak solution, as its action is more likely to be even and can be more easily controlled, but at the same time too long soaking in the bath may stain the negative yellow.

After a few trials you will learn how the operation should proceed, and will mix your solutions accordingly. Keep a close watch on the negative, and as soon as it appears thin enough give it a thorough washing, for half an hour at least. If, on making a trial print after the negative has dried, it still lacks contrast, intensify it as already explained, and in all probability it will show great improvement. The action of Farmer's reducer on a plate is like that of a carpenter's plane on a board. It takes off an even layer from the whole surface, changing the relative densities of the different parts little, but slightly increasing the contrast. For harsh, under exposed and contrasty negatives a reducer of the opposite sort is needed, one that will take hold of the dense portions, while acting slightly on the thin parts. It is only within the last few years that a reducer of this character has been known, but at the present time we have an excellent article for this purpose, known as ammonium persulphate. It can be bought at any photographic supply store for about 20 cents an ounce, an ounce being sufficient for dozens of negatives. To use it, dissolve 30 grains in 3 ounces of water. Prepare also a solution of sodium sulphate, say 75 grains to an ounce of water, which is practically a 10 per cent solution. Give the faulty negative a good preliminary washing and then place it in the reducer. Reduction begins at once and must be carefully watched. Just before the right point

is reached rinse the negative and place it in the sulphite solution, which at once checks all reducing action. After 5 minutes in this bath give the negative a 2 minute wash and place it in the fixing bath for 10 minutes. After this, wash for half an hour. This process is useful, and I advise every amateur to keep a supply of persulphate on hand, as by its use one may produce a wonderful improvement in many faulty negatives.

Local reduction or intensification may be tried with the foregoing solutions in case a small portion of the negative needs treatment. For instance, a window in an interior view which is badly blurred may be reduced by careful work with a soft brush wet with Farmer's solution, which has been mixed with a few drops of gum arabic solution to prevent it from spreading. This reducing solution soon loses its power and should be mixed just before use. This brush work is slow and requires great care, but the results often repay one for the time and labor involved.

In case of a landscape negative having a sky which has good clouds, but which is too dense to allow the clouds to print out, this method is useful. Give the negative a good soaking, then hold it in a slanting position, sky down, over a tray containing 2 or 3 ounces of the reducer. With a tuft of cotton go over the sky, spreading the reducer evenly and working close to the horizon line. Rinse off the reducer frequently, as this prevents a sharp line at the horizon, where the action of the reducer stops.

Both bichloride of mercury and potassium ferricyanide are poisons and should be handled carefully or serious results may follow.

C. M. Whitney, Bayonne, N. J.

HALATION.

The chief cause of halation is that strong light penetrates the film, passes through the glass, strikes the back surface of the plate and is reflected back into the film, thus giving a double light action where the light has acted too strongly already. For example, notice the halo about the windows in interiors, and the edges of dark objects taken against a bright sky. In photographing snow scenes and clouds halation is exceedingly troublesome and generally present. To prevent halation we must either prevent the light passing through the plate or else absorb it when it does pass through, so it will not be reflected back again.

The first method is to use a double coated plate. These plates have first a slow emulsion and then a quick emulsion on top. So much of the light is absorbed before pene-

trating this double coating that there is little if any to be reflected back again. The chief objection to the double coated plate is that development must take place in a much diluted developer, which prolongs development; and in addition these negatives are so dense that it is often difficult to judge when development should be stopped. Fixing takes place slowly and the negatives must be washed twice as long as the ordinary plate.

To absorb the light when it has once passed through the plate, coat the back of the plate with some opaque substance. Some plate makers have backed plates on the market. For those who desire to back their own plates numerous preparations are on the market. Another good method is to coat the back of the plate with a sheet of black paper. Care must be taken that the paper is in actual contact over the whole surface of the plate. Paper cut to the proper sizes can be bought of the supply dealers.

When developing plates which are liable to show more or less halation it is well to develop tentatively, never overdeveloping and often stopping as soon as detail is complete, even though density is lacking. Such negatives will show much less halation than if fully developed and can be intensified sufficiently to make good prints.

R. L. Wadhams, M.D., Wilkes-Barre, Pa.

SNAP SHOTS.

Some time ago I saw a formula in RECREATION for an instantaneous toning bath. I have tried it several times and have found it satisfactory in every respect except one. About every third print tones with metallic brown spots on it. Whether that is my fault or not I have not been able to determine. Will you advise me what the matter is?

L. R. Anderson, Oxford, Iowa.

ANSWER.

Metallic spots appearing on printing out paper in the toning bath, are often caused by using metal forms for trimming prints, either oval or square. Small particles of the metal adhere to the paper. The spots may also be due to defective paper. I suggest referring the matter to the manufacturer of the paper.—EDITOR.

A negative might often be improved by intensifying. Before intensifying, a negative should be placed in a weak reducer a few seconds, then washed thoroughly, after which it should be intensified. Give this a trial and you will be surprised at the superior results obtained over the old method.

C., Bethlehem, Pa.



Vacation Days Are Kodak Days

The Kodaker has all the vacation delights that others have—and has pictures besides. And there's pleasure in the making as well as in the possessing of Kodak pictures.

Every step is simple now. No dark-room at any stage of the work, and better results than ever.

KODAKS, from \$5.00 to \$97.00.

EASTMAN KODAK CO.

Rochester, N. Y.

The 1904 Catalogue is an illustrated news letter from Rochester, the Home of the Kodak. Free at the dealers or by mail.

"Century" Cameras

A New Idea—

Century Cameras With Revolving Back



The most valuable improvement made in the construction of Hand Cameras in recent years. Ask your Dealer or write us to-day for new Catalog, describing complete line of 1904 Centurys—from the dainty little Petite to the King of all Cameras, the Century Grand.

CENTURY CAMERA CO., Rochester, N.Y.

Do you want a Good, Reliable,
Substantial, Well Made

Single Barrel Shot Gun

If so, send me

10 YEARLY SUBSCRIPTIONS

and I will send you such a
Gun as a premium

It is made by the *DAVENPORT ARMS CO.*, and this means it is made of good material and that only good workmanship is put on it.

This is one of the many remarkable opportunities *RECREATION* is offering to men and boys to fit themselves out completely for shooting and fishing.

Sample Copies for Use in Canvassing
Furnished on Application.

Address

RECREATION

23 W. 24th St., New York City.

To bring up underprinted platinotypes during development, remove them from the developer and hold them in front of a fire or over a smokeless gas stove. The heat acts on the developer remaining in the prints, and so strengthens the image.—Exchange.

I received the rifle wick plug from Hemm & Woodward and pronounce it the best rust and pitting preventive I have seen. Please accept my thanks. I soaked the wick in gun oil and expect no rust in the rifle barrel.

W. J. Trebilcock, Ishpeming, Mich.

To cover the top of the developing table a remnant of good linoleum has served me excellently a year or more. Ordinary floor polish both cleans and protects it well; and it is sufficiently soft to prevent breakages.—Photography.

I am in receipt of the Marble safety pocket ax sent me as premium, and am pleased to say it is very satisfactory. It is certainly a work of art and is put up in shape that reflects great credit on the maker.

L. D. Crandall, Truxton, N. Y.

I received the Davenport gun you sent as a premium, and am well pleased with it.

J. P. Williams, Kingston, Wis.

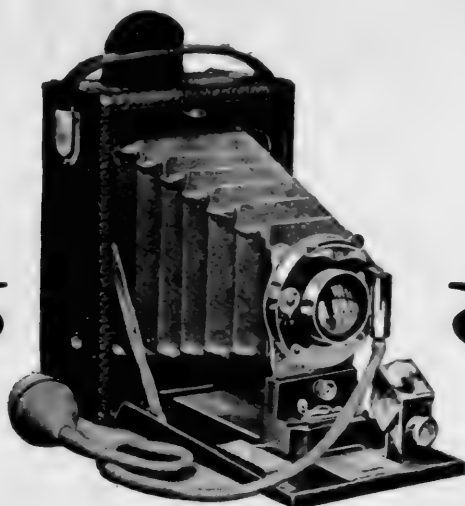

JUST THREE SECONDS TO LOAD THE

Folding Film PREMO

It's done in daylight with the PREMO FILM PACK

The Folding Film Premo is pocket size; fitted with a lens and shutter capable of the most delicate photographic work.

The $3\frac{1}{4} \times 5\frac{1}{2}$ size is particularly adapted to making post card pictures.

PRICES

PREMO FOLDING FILM	$3\frac{1}{4} \times 4\frac{1}{4}$	$3\frac{1}{4} \times 5\frac{1}{2}$	4 x 5
CAMERA, No. 1	\$10.00	\$12.50	\$12.50
PREMO FILM PACK, 12 Exposures,	.70	.80	.90

ASK THE DEALER OR WRITE US FOR PREMO CATALOGUE

Mention RECREATION.

ROCHESTER OPTICAL CO.
ROCHESTER, NEW YORK

DO YOU WANT A FOLDING CANVAS BOAT?

If So, Send Me

35 Yearly Subscriptions to RECREATION

AND I WILL SEND YOU

A 14 ft. King Folding Canvas Boat

LISTED AT \$48

capable of carrying 2 men and an ordinary camp outfit. There are thousands of these boats in use, and nearly every man who is using one of them praises it on every occasion.

Sample copies of RECREATION for use in canvassing will be furnished on application.

Address 23 West 24th St., New York

It's Not a Toss-Up



as to the quality of pictures made with a
KORONA Camera



GUNDLACH-MANHATTAN OPTICAL CO., 730 So. Clinton Ave., Rochester, N. Y.

YOU CANNOT BUY A
KORONA CAMERA

from the Photographic Dealer nowadays because the
P H O T O G R A P H I C T R U S T
 prohibits it, in effect, by making him forfeit a large
 part of his profit on *their* goods, if he dares to buy
 and sell *ours*.

If your dealer is one of these, or if no dealer in
 your town handles our products, **we'll let you keep
 the profit the dealer formerly made.**

Write for catalogue and discounts. This is an
 unprecedented opportunity to buy the peerless
KORONA CAMERA at wholesale price. We
 manufacture also **BINOCULARS, TELE-
 SCOPES, MICROSCOPES** and other optical goods

Gundlach-Manhattan Optical Co.

730 South Clinton Avenue, Rochester, N. Y.

Mention RECREATION.



The reputation, skill and accuracy which stand behind the Goerz lens are offered with the "Sector" Shutter.

"It's a Goerz Product"

The mechanism of the "Sector" Shutter is beautifully simple yet combines those necessary qualities which will be appreciated by all photographers. We want you to know all about the "Sector." Send your name and address and an interesting booklet will be mailed free by return mail.

C. P. GOERZ,

Room 27 52 E. Union Square, - - - New York City

**LANTERN SLIDES COLORED
SKILLFULLY AND ARTISTICALLY
FOR
Lecturers, Teachers and others**

I refer by permission to the Editor of RECREATION

MRS. C. B. SMITH
The Ansonia, 74th St., & Broadway,
New York City.

LEST YOU FORGET, IN A FIT OF ABERRATION, I SAY
IT AGAIN, PLEASE MENTION RECREATION.

Something Special — Playing Cards
Free:—To each person sending me \$1 for one year's subscription to RECREATION, or sending it direct to be placed to my credit, I will forward, all charges prepaid, a pack of elegant gold edge playing cards. These are no cheap second quality cards but first quality of extra selected stock, highly enameled and polished, fancy set pattern backs, each pack wrapped in handsome glazed wrapper and packed in strong telescope case.

L. J. Tooley,
141 Burr Oak St., Kalamazoo, Mich.

For Golf & Tennis Players

"PRESTO! — CHANGE!"

ATTACHABLE EYEGLASS TEMPLES

GLASSES WITHOUT TEMPLES

GLASSES WITH TEMPLES

Eye Glasses into Spectacles. Spectacles into Eye Glasses

BE PROTECTED!

DON'T BREAK OR LOSE YOUR GLASSES IN EXERCISE, WIND AND STORM

Can be attached by anyone *Send thickness of lens when ordering by mail*

Price in Nickel 50c. a pair. Gift 75c. a pair. Gold Filled \$1 a pair. Solid Gold \$2.50 a pair.

Established 1842 GALL & LEMBKE, Dept. C, 1 W. 42d St. 21 Union Sq., New York Send for Circular



COMBINATION HAWK-EYE

A New Film Camera which allows the operator to focus on ground glass.

May also be used with glass plates.

Fitted with Extra Rapid Rectilinear lens, B. & L. Automatic Shutter, rising and falling front controlled by rack and pinion.

No. 3 Combination Hawk-Eye, pictures $3\frac{1}{4} \times 4\frac{1}{4}$, equipped for film and plates, - - \$27.50

BLAIR CAMERA COMPANY,

Send for Catalogue.

ROCHESTER, N. Y.



Condensation of moisture on the window or negative when printing is done in frosty weather may be prevented by cleaning and polishing the glass of each with a cloth moistened with glycerine.—Photography.

The double, hammerless Syracuse gun reached me all right. It greatly exceeds my expectation and is a most liberal premium.

L. R. Cogswell, Somerville, Mass.

I am much pleased with my premium, a Harrington & Richardson revolver.

Robert Charlie, Kent, O.

OIL PORTRAITS ON APPROVAL

If you will send me a photo of yourself or a friend and state color of hair, eyes and complexion, I will paint and send you on approval an oil or pastel portrait, miniature or life size.

Canvas, 6x8 or 8x10 inches, **\$10**

Canvas 10x12 or 12x14 inches, **\$15**

Three-quarters life size, - - **\$25**

Full life size, - - - - - **\$35**

Z. EMMONS, 58 West 104th Street

Reference: Mr. G. O. Shields.

New York



A RECORD

of all the happenings and incidents of your trips enables you to enjoy them over and over. The BEST records are made with

COLLINEAR LENSES

The fastest and truest lenses; fit any camera.

Send for Booklets to

**Voigtlaender & Son
Optical Co.**

137 West 23d St.

Dept. E New York

MY FIRST RIFLE.

K. S.

When about 11 years of age, my cousin, who was about the same age, put it into my head to ask my father to buy a gun, his father promising him one providing my father should agree to get me one. My uncle no doubt imagined the matter would end there.

The mere mention of gun was sufficient to arouse my ambition to own one, as that had long been my fondest dream; so I immediately set to work, on the ground that my cousin was going to have a gun and that I was as good a boy as he was. I argued that by getting 2 guns together we could get a discount on them.

After several days of coaxing and good behavior, my father gave me \$6.40, which was the price of a 22 caliber rifle and 1,000 cartridges.

I held my breath for joy. I pinched myself to see if I was awake, for it seemed too good to be true.

I lost no time in rushing over to my cousin's house, which was $2\frac{1}{2}$ miles across farms, to deposit the money with him, as they were to send for the rifles. Between gasps I stated my errand. Then my cousin pinched himself to see if he was awake. I produced the cash, carefully knotted in one corner of my handkerchief. This was convincing, and without saying another word we both struck out at top speed to a large tree by the roadside, fell in the shade, rolled over, laughed and kicked each other.

After our spasms were over, we began to speculate on how long it would take the guns to come. We thought that if we could get the money off that night we would surely get the guns early Monday morning. But the money did not go until Saturday.

We watched the clock and counted the days 2 whole weeks, and never in my life did school days seem so long.

On Tuesday morning over 2 weeks after the guns were ordered, my parents sent me to town to my grandmother's on an errand. She imparted the joyful news that my uncle had been in the evening before, had taken the guns out, and that my cousin would bring my gun over the following Saturday.

I wanted to take a day off and see the guns, but was told that it would not be long until Saturday. This did not seem to shorten the days. Every night I went to bed early, that I might pass as much of my time in sleep as possible.

Finally Saturday morning arrived, cold and clear. After doing my morning chores about the farm, my thoughts not being entirely on my work, I stationed myself where I could command a good view of the road.

I had not long to wait, for I soon saw the 2 boys coming. That was enough. I climbed down from my perch and started across the orchard. On seeing me they gave a wild yell, and I returned the salute without stopping. I could see the bright barrels and the varnished stocks

flash in the sunlight, and oh! what a sight it was! Over 20 years have passed since then, but I can never forget that brilliant spectacle.

Another moment and I was reaching for the nearest gun. What a beautiful piece of workmanship it was! Nickel-plated mountings, octagon barrel, just the right size and a breech loader.

My cousin promptly told me which one he would like to have, but added that I might have my choice, as he had sent in the order. I granted him choice, as both guns to me seemed immaculate.

The next thing to be done was to shoot at something. A cartridge was promptly placed in the breech and almost as quickly fired at the well curb less than 20 feet away. In my excitement I almost missed it; but this did not discourage me. I loaded and fired again, with better success, placing a ball within 2 inches of my first. If a grizzly had appeared at that moment he would have received 2 balls from our deadly weapons.

After shooting all day at real and imaginary animals, some of the latter the largest that had ever been seen in those parts, my cousins returned home and I cleaned my gun, oiled it, rubbing some of the browning off the barrel in my effort, and put the gun in a corner near to my bed where I could reach out in the night and get it should burglars enter the house. I awoke several times that night and reached for the gun, although no burglars were in sight or hearing. I carefully took aim where one might have been standing and pulled the trigger.

The next day being Sunday. I took an inventory of stock, and found that I had shot away 120 cartridges.

Although I have owned a dozen guns since, some of which were high priced ones, none ever gave me the delight and the satisfaction I had in the possession of my first little 22 rifle.

Pretend to love your enemies. There's more money in it than in showing them your hatred. If you rob a man of his coat try to get his cloak also.

If your right eye offend you, go to a specialist.

Don't let your right hand know what your left hand is doing. There is no use in being too much ashamed of yourself.

Take no thought for to-morrow. Look out for the day after to-morrow, and to-morrow will take care of itself.

Consider not your raiment. Pay your dressmaker or your tailor enough so you will not have to.

Amateur—This is my latest attempt at a landscape. What do you think of the perspective?

Artist—The perspective is its strong point. The farther away you stand the better it looks.—Chicago Tribune.



Young Man

If you intend to win out in life you will need a clearer head and steadier nerves than the coffee drinker usually has.

Science tells us plainly that coffee contains elements which directly attack the heart, kidneys, nerves, and cause indigestion and many other ails.

You can have a hot beverage with the coffee flavor and rich color without any of the bad effects of coffee if you will shift to well boiled POSTUM COFFEE, the food drink, delicious when properly made (that's easy), and absolutely free from the Caffein and other nerve-killing elements of coffee.

Read the little book, "The Road to Wellville," you will find in every package of

POSTUM.

P. S. Discuss this coffee question in the family, and observe the experience of each.

Dr. SCOTT'S ELECTRIC HAIR-BRUSH

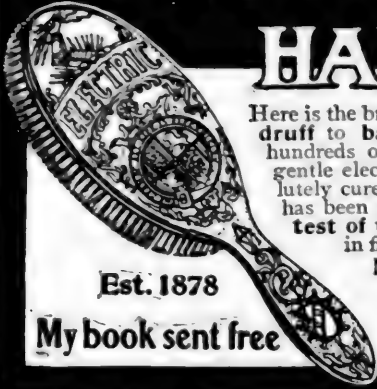

Here is the brush that will cure all scalp disorders, from **dan-druff** to **baldness**, if conscientiously used. We have hundreds of unsolicited testimonials to that effect. The gentle electric current imparted by the brush will absolutely cure nervous headaches and neuralgia. My brush has been on the market for 26 years and has **stood the test of time**. Made from selected bristles—no wires—in five sizes and sent postpaid to any address.

No. 1, \$1.00 No. 2, \$1.50 No. 3, \$2.00 No. 4, \$2.50 No. 5, \$3.00

Prices differ only according to size and power. If not satisfactory your money will be refunded.

Dr. GEO. A. SCOTT, 870 Broadway, NEW YORK.
Agents Wanted Everywhere

Est. 1878

My book sent free

\$5.75 PAID FOR RARE 1853 QUARTERS; \$4 paid for 1804 dimes; \$15 paid for 1858 dollars; big prices paid for hundreds of other dates; keep all money coined before 1879 and send ten cents at once for a set of two coin and stamp value books. It may mean a fortune to you. Address C. F. Clarke, Agent, Le Roy, N. Y., Dept. 3.

Free: To any one sending me 5 new yearly subscriptions to RECREATION, I will give 1 pair Snowshoe Rabbits or will sell for \$4 a pair. Stanley L. Trees, Tie Siding, Wyoming.

For Sale:—Columbia Graphophone with 17 Band Disk Records, all perfect and warranted. Cash \$45; will take \$22. R. G. S., 280 Putnam Ave., Detroit, Mich.

IN ANSWERING ADS. PLEASE MENTION RECREATION.

Los Angeles and San Francisco and Return, \$67., via Southern Railway and New Orleans. Berth rate in through tourist sleepers from Washington \$8.50 in each direction. Tickets will be sold April 22d to 30th, 1904; going transit limit June 25th. Stop overs at points in Texas and California. Final return limit June 30th, 1904. Going via New Orleans and returning via St. Louis \$70. One way colonist tickets from New York to points in California on sale daily during April \$50. For further information write to or call at Southern Railway Offices, 271 and 1185 Broadway, New York.

ALEX. S. THWEATT,
Eastern Passenger Agent.

A Fountain Pen

has become a necessity with every business man. You can get a

Laughlin Fountain Pen

Made by the Laughlin Manufacturing Co.
Detroit, Michigan

For 2 Yearly Subscriptions to RECREATION

And you can get these 2 subscriptions in 20 minutes, any day.

The Laughlin is one of the best pens in the market, and thousands of them are in daily use.

There is no reason why you should be without one.

Sample Copies of RECREATION for use in Canvassing
Furnished on Application



NEW-SKIN
TRADE MARK REGISTERED
WATERPROOF

LIQUID COURT PLASTER

Heals Cuts, Abrasions, Hang-Nails, Chapped and Split Lips or Fingers, Burns, Blisters, Etc. Instantly Relieves Chilblains, Frosted Ears, Stings of Insects, Chafed or Blistered Feet, Callous Spots, Etc., Etc.

A coating on the sensitive parts will protect the feet from being chafed or blistered by new or heavy shoes.

Applied with a brush and immediately dries, forming a tough, transparent, colorless waterproof coating.

Sportsmen, Motorists, Golfers, Mechanics, Etc.

are all liable to bruise, scratch or scrape their skin. "NEW-SKIN" will heal these injuries, will not wash off, and after it is applied the injury is forgotten, as "NEW-SKIN" makes a temporary new skin until the broken skin is healed under it.

EACH
Pocket Size (Size of Illustration), 10c.
Family Size, - - - - - 25c.
2 oz. Bottles (for Surgeons and Hospitals), - - - - - 50c.

At the Druggists, or we will mail a package anywhere in the United States on receipt of price.

Douglas Mfg. Co.

96-102 Church St.
Dept. W, New York.

Thousands Pity You

If You Don't Know

The Sure Relief, Prevention, Cure
Now Dispensed the World Over by

Orangeine

Powders.



**"Easy to Carry," "Easy to Take," "Never Harms,"
"Produces Quickly the Desired Effect" on**

Colds, Headache, Grippe, Neuralgia, Fatigue, Stomach Upsets and "Those Every Day Ills of Life," "Saves time and money from worse than waste," Increases life's energy and productiveness. Assures ability to meet life's labors and engagements free from pain and suffering.

Expressions from Experience.

Mr. Wm. Hughea, a prominent banker, of Newport, R. I., says: "I can substantiate all claims you make for Orangeine, for I have seen it do wonderful work in my own family and among my friends."

Mr. C. A. Henderson, Austenburg, O., writes: "I would not be without Orangeine for a day. It is all and more than you claim for it."

Mr. Albert C. Smith, President Suffolk Hospital & Dispensary, 4 Charter St., Boston, Mass., writes: "Orangeine has fully proved its remedial value, and we are glad to say that we never allow our institution to be without this medicine."

Mr. J. W. Tillinghast, Buffalo, N. Y., writes: "During the past year, myself, and my family, including two little boys, have learned the high value of Orangeine. Incipient colds are quickly dispelled, headache stopped, physical or mental fatigue corrected."

Test and Information Free 10c Trial Package FREE on receipt of request.

NOTE—Orangeine is now sold by all progressive druggists in 10c packages (2 powders); 25c (6 powders); 50c (15 powders); "Family Package" \$1.00 contains 35 powders—or mailed anywhere by The Orangeine Chemical Co., 15 Michigan Avenue, Chicago.

Every true sportsman is glad to see RECREATION continue its warfare on the game hog, who is the common enemy alike of the game and the hunter. It is only justice that you are meting out to the destroyer of the game, and if he will break the laws of decency and of statute then let the law punish him. However much the sportsman may enjoy the chase, he is willing to stake his judgment against the instinct of the wild animal, and is satisfied with enough. His motto is "fair play or go hungry." However, let us hope that through the combined efforts of RECREATION and the intelligent and fair minded hunters, even the game destroyer may be educated to be fair, and to do the right thing by the animals and by his fellow men.

Geo. W. Lacea, M.D., Brooklyn, N. Y.

A GAME HOG IN BUSINESS.

A clothing dealer in an Ohio town printed this announcement in a local paper last spring.

We will give, free, to the hunter who kills the largest number of Wild Ducks in one day, between March 15th and April 15th, a first class Hunting Jacket guaranteed to fit. The only condition is that you must show us the ducks.

No question about the bristles there.—
EDITOR.

Andrew Ellsworth, of Fairmont, Ind., killed 2 rabbits in violation of the State law. Game Warden Bravy took Ellsworth before the judge, who fined him \$42.50, a mighty stiff price to pay for rabbit stew.

MENNEN'S BORATED TALCUM TOILET POWDER

A Positive Relief For PRICKLY HEAT, CHAFING, and SUNBURN, AND ALL AFFLICTIONS OF THE SKIN.

"A little higher in price, perhaps, than worthless substitutes, but a reason for it." Removes all odor of perspiration. Delightful after Shaving. Sold everywhere, or mailed on receipt of 25c. Get Mennen's (the original). Sample Free.

GERHARD MENNEN CO., Newark, N. J.

ARNICA Tooth Soap
the International Dentifrice

Beautifies the teeth, hardens the gums, sweetens the breath. Preserves as well as beautifies the teeth. Comes in neat, handy metal boxes. No powder to scatter, no liquid to spill or to stain garments.

25 Cents
At all Druggists.

C. H. STRONG & CO., Proprietors,
Chicago, U. S. A.

The Cure of Morphine, Laudanum and other Drug Habits.

A CURE PERMANENT AND COMPLETE.

is made with an absolute certainty by the St. James Society of New York. By the use of a clean, pure and scientific preparation the insidious drug habit is promptly driven away, and health, strength and joy in life comes in its place.

Frequently only a ten days' trial treatment, which is entirely free of cost, will bring about a thorough cure. The effect of the treatment is simple. It first removes absolutely the irresistible craving for the drug. Then it places all the functions of the body in a normal condition, so that the former sufferer gets back his vigor; his health, happiness and confidence return.

There is absolutely no question about this. We could fill this whole magazine with letters from those who, with a sincere and intense gratitude, have thanked the Society for its cures. Here is one of them, from a prominent resident of Homer, N. Y.:-

"A trial bottle of your remedy came duly to hand, and with that alone a perfect cure was effected, for I have not used the drug after beginning your treatment, and am now a free man. I begin to eat well and sleep well. Thanking you for your kindness and hoping you are enjoying God's choicest blessings, I am your grateful friend forever."

For the protection of those who seek our relief, we keep in strictest confidence all correspondence. The names of all those who write to us are locked securely in a steel vault and never under any circumstances disclosed to any one. If you desire, your letter will be returned to you with our answer. We keep in closest secrecy the affairs of those who come to us, for we give encouragement and comfort to those who are bitterly unfortunate. Our medical director may be seen privately at any time with the positive knowledge and assurance that he keeps all confidences, and an effective system of records enables us to follow the progress of each patient daily.

No matter how long the habit has been fastened upon you, no matter how large the quantity of the drug you habitually consume, no matter if physicians and your friends have told you that your case was hopeless, we know that our treatment will completely cure you, for we have already cured many thousands during the last six years.

We are now shipping our antidote to all parts of the world. It is used by 84 large sanitariums and by 4,000 physicians in their private practice.

Write to us about your case today; you will receive help without a cent of cost to you.

Freely address in strictest confidence the St. James Society at its general offices, Suite 118, 1,183 Broadway, New York, N. Y.



H. J. TILLOTSON, M. D.
The Master Specialist of Chicago, who Cures Varicocele,
Hydrocele, and treats patients personally.
Established 1880.
(COPYRIGHTED)

Varicocele Hydrocele

**Cured to Stay Cured in 5 Days.
No Cutting or Pain. Guaranteed
Cure or Money Refunded.**

VARICOCELE, Under my treatment this insidious disease rapidly disappears. Pain ceases almost instantly. The stagnant blood is driven from the dilated veins and all soreness and swelling subsides. Every indication of Varicocele vanishes and in its stead comes the pleasure of perfect health. Many ailments are reflex, originating from other diseases. For instance, innumerable blood and nervous diseases result from poisonous taints in the system. Varicocele and Hydrocele, if neglected will undermine physical strength, depress the mental faculties, derange the nervous system, and ultimately produce complicated results. In treating diseases of men I always cure the effect as well as the cause. I desire that every person afflicted with these or allied diseases write me so I can explain my method of cure, which is safe and personal, and my charges for a perfect cure will be reasonable and not more than you will be willing to pay for the benefits conferred.

Certainty of Cure is what you want. I give a legal guaranty to cure or refund your money. What I have done for others I can do for you. I can cure you at home.

Correspondence Confidential. One personal visit at my office is preferred, but if it is impossible for you to call, write me your condition fully, and you will receive in plain envelope a scientific and honest opinion of your case, Free of charge. **My home treatment is successful.** My books and lectures mailed free upon application.

H. J. TILLOTSON, M. D., 140 Tillotson Bldg, 84 Dearborn St., CHICAGO

DYSPEPSIA

and other

STOMACH TROUBLES

quickly relieved and positively cured by the use of

"Glycozone"

an absolutely harmless germicide. Subdues inflammation, and, by cleansing the membrane of the stomach of abnormal secretions, restores it to perfect health and effects a cure.

Used and recommended by leading physicians everywhere for the last ten years.

Sold by leading druggists, or sent prepaid on receipt of \$1.00.

None genuine without my signature on label.

Prof. Charles Marchand

Dept. F - 59 Prince St., New York

FREE - Valuable Booklet on How to Treat Diseases

Certain California game and fish wardens have been especially busy of late. Here are reports of a few cases they have run down:

Mrs. Ellen Crow was arrested yesterday for offering quail for sale and having a larger number in her possession than the law permits. She had 85 birds in a hamper when apprehended, while the law limits the number to 25. The Fish Commissioners regard her arrest as an important capture, because she disposed of the quail shot by her husband and other hunters with headquarters in the hills back of Hayward. The men made a regular practice of shooting quail in violation of the game laws and sent their wives to dispose of the contraband birds, in order to escape detection. The women brought the quail in hampers and baskets. Mrs. Crow was released on depositing \$50 cash bail.

Deputy Fish Commissioner W. P. Huestis arrested Walter Kannon at Forest Home, Humboldt county, with about 100 pounds of deer meat in his smoke house. Justice Deigham, of Rio Dell, fined Kannon \$25 for the offense, saying that he imposed the minimum fine out of consideration for the prisoner's family.

Deputy Fish Commissioner Thomas Rhodes arrested Ben Jarvis near Fort Bragg, Mendocino county, with fresh deer meat in his possession. Justice Whipple of Fort Bragg fined Jarvis \$30. Deputy Rhodes also arrested E. O. Sallinen and O. C. Sallinen for using set nets in the Noyo river, near Fort Bragg. Justice Whipple, before whom they were taken, held them to answer before the Superior Court at Ukiah. The minimum penalty for the offense is \$100.

Deputy Fish Commissioner A. F. Lea arrested C. Farratti and A. Marchotti near Hopland, Mendocino county, for having the head and hide of a female deer in their possession. They pleaded guilty before Justice Armstrong, of Hopland, of having killed a doe and were fined \$50.

POND'S EXTRACT

*The Old
Family
Doctor*

CURES

Burns, scalds, bruises, cuts, sprains, wounds, lameness, soreness, neuralgia, rheumatism, sunburn, bites, stings.

STOPS

Nose bleed, toothache, earache, bleeding lungs, hemorrhages and all pain.



*Sold in sealed
bottles with
buff wrappers*

ACCEPT NO SUBSTITUTE

HIGGINS & SEITER

Fine
China

Rich Cut
Glass



Flemish Punch Bowl No. 865

11 in. high, 13 in. opening, plain ivory figures, background, dark green and brown, \$5.65.

We illustrate our "**1/4 Less than Elsewhere**" policy by pricing this extra fine

Flemish Punch Bowl

(see illustration)

For thousands of other offerings equally attractive send for Catalogue No. 14 "U" having delicately tinted pictures of choice china. Free to all interested in purchasing.

West 21st and West 22d Streets
Near Sixth Avenue NEW YORK CITY

"Buy China and Glass Right"

Take good care of your hands

You may need
them next year

Send me
2 yearly subscriptions to **Recreation**
and I will send you
a pair of **Leather Hunting Gloves**
made to your measure, by the
Luther Glove Company
Berlin, Wisconsin

*Sample copies for use in canvassing
furnished on request*

Free:—To any person sending a new yearly subscription to RECREATION through me I will send a fine Nickel Folding Drinking Cup and Dog Whistle, listed at 60 cents, or a hard rubber, water proof Match Safe, listed at 50 cents, or a Canvas Belt with loops, listed at 60 cents, or a Revolver Leather Holster Belt, listed at 50 cents, or a choice of a Horn Whistle or Star Vest Pocket Whistle, or a Duck, Snipe, Turkey or Echo Call, each listed at 50 cents, or a Rifle Cleaning Rod, 22 or 32, with scratch and bristol brush, listed at 50 cents, or a choice of a Dandy, Star or Perfect Oiler, very fine and handy, and each guaranteed not to leak, listed at 50 cents each, or a Powder or Shot Measure, listed at 35 cents, or a coin Money Purse, genuine soft kid, three compartments, listed at 50 cents, or a Money Pouch, made of fine sheep skin, with draw string, very fine, listed at 75 cents, or a self-closing rubber Tobacco Pouch, listed at 50 cents, or a high grade French Brier Pipe, listed at 75 cents, or a Fountain Pen, listed at 75 cents, or a lightning Fish Scaler, or a spring lock Hook Shield, or a Spring Gun Cleaner, or a Rubber Hook Shield, or a Little Giant Small bore Rifle Cleaner.

Edward Jacobs, 227 Mulberry St., Coshoc-
ton, O.

I buy no sporting goods that are not advertised in RECREATION.

S. W. Peregrine, Portland, Me.

LITTLE HELPS FOR THE AMATEUR.

A good method of toning bromides brown is with copper ferricyanide, as every degree of tone, from blackish brown to brilliant red, is obtainable, according to the length of time the solution acts. Immerse the fixed and well washed prints in the following: Dissolve 140 grains of neutral potassium in 8 fluid ounces of water, then add 20 grains of crystallized copper sulphate, and finally 9 grains of potassium ferricyanide. Keep the prints in motion, and allow the bath to act until the desired tone is produced; then wash thoroughly. The solution must be used while fresh.

When negatives take a long time to print on account of being too yellow, as is sometimes the case when developed with pyro, they can be toned to a suitable color in the following bath:

Sulphocyanide of ammonium, 8 grains.
Chloride of gold, 1 grain.
Water, 2 ounces, M.

What is commonly called green fog or iridescent stain, caused by the use of old plates, forcing under timed plates in development, or the use of plates that have not been properly stored, may be removed by bleaching the image in a solution of:

Water 5 ounces
Ferrichloride 60 grains
Bromide of potassium.....120 grains

When bleached, wash the plate well and re-develop in old iron oxalite developer. This process is usually effective, if the stains are not too old. Very light stains may sometimes be removed by rubbing them with a tuft of absorbent cotton saturated with methylated spirit.

In local reduction it is often well to mix the reducer with glycerine to prevent it from spreading over portions of the negative where it is not wanted. When fine lines or portions of the negative are to be reduced the solution should be applied with a fine camel's-hair brush, while the film is dry, but when large portions are to be reduced the film should be wet. Excellent results may often be accomplished by local reduction, but some skill and great care are required to make the process a success.—Exchange.

I thank you for the pair of shot gun wick plugs, manufactured by Hemm & Woodward, of Sidney, O., which were sent to me for subscriptions for RECREATION. They are the right thing, without a doubt, for proper care of barrels.

C. N. Ong, Lacon, Ill.

There is something about RECREATION that always appeals to a true sportsman, and makes those who are not sportsmen wish to be such.

J. C. Wise, 2d Lieut. 9th Infantry,
Madison Barracks, N. Y.



The Beer
of Quality

Perfect Malt and Choicest Hops

make Pabst Blue Ribbon the premier product of modern scientific brewing. The malting process invented and perfected by Pabst takes twice as long as the process in common use. But malt is the soul of beer. It is what makes

Pabst Blue Ribbon

the Beer of Quality, rich, mellow, palatable and wholesome—the very life of the barley-grain caught and blended with the choicest hops in a brewery where purity and cleanliness are supreme from brewing vat to bottle. Pabst Blue Ribbon is the brew of all brews for the home and the club. Pabst Blue Ribbon is a malty beer, exquisite in flavor and full of health and strength. It is



The Beer
of Quality

AN OLD ENGLISH CANDY

Let me tell you if you want to get all the sweets of life you cannot afford to ignore or overlook

MACKINTOSH'S EXTRA CREAM TOFFEE

an old English candy that I am introducing into this country. Its exquisite flavor has made it popular in Great Britain, and the same quality is creating a demand for it in this country. I have put it on the American market because I know American people like good things. Ask your dealer to supply you with MACKINTOSH'S TOFFEE. Try him first. You can, however, buy a handsome family tin weighing four lbs. for \$1.00 by mail. Large sample package sent for 10c. in stamps. LAMONT, CORLISS & CO., Importers, 78 Hudson St., New York City.

Dealers supplied everywhere through them.



New Hampton, Iowa.

The Peters Cartridge Co.,
Cincinnati, Ohio.

Dear Sirs: I note the withdrawal of your ad and support from RECREATION with surprise and regret.

When you inserted your advertisement you doubtless knew the scope and circulation of the magazine; also that Mr. Shields edited a department known as Guns and Ammunition. It is now apparent that you intended to continue your ad only as long as you were exempt from criticism, as on its first appearance you withdrew your patronage. Other makes of guns and ammunition have been criticised more severely than you, though, as in the case of everything good, their friends outnumber the critics 100 to one. The pages of RECREATION were open to your defence and if you or your friends had offered any it would undoubtedly have appeared. The more "manifestly unjust" the criticism and more ignorant the critic, the more easily is he refuted and disproved.

The experience of my friends and myself with Peters' 22 short ammunition in Marlin and Winchester repeaters and Stevens rifles, also in a Stevens pistol, has been unsatisfactory. About 3 out of 5 cartridges fired split lengthwise, some blowing the neck of the shell completely off. The Stevens pistol referred to was finally burst by your ammunition, and was repaired by its makers without question or charge. From this experience I am satisfied that that particular batch of ammunition, at least, was defective; such being the case, might not the criticism to which you objected have had equally good foundation?

By reference to your files you will find that I sent a criticism to Mr. Shields, which he forwarded for your inspection, and to give you a chance to explain. He wrote me that he extremely disliked to publish it without further enlightenment, and I did not press the matter. I believe many criticisms of your goods have been withheld by his readers, out of respect to the fact that you were supporting him by your ad. Honest criticism of any line can do no harm, and just as long as you are apparently afraid of it, just so long will sportsmen be afraid of your goods. Any line of ammunition is dependent for its success not on the expert with shot gun or rifle, but on the great body of sportsmen at large, who will stand by Mr. Shields in case the line is drawn.

The only inference possible from your action is, that when a firm contracts for advertising space, and gets value for its money, it expects to have the editor thrown in, body and soul. Fortunately, "it can't be did," in the case of RECREATION.

I trust that future issues of RECREATION will contain your ad and thus prove that your withdrawal was an error of the head and not of the heart.

John Lawrence.



Club Cocktails

Famous the world over for purity. They never vary. The secret of their perfect blend is that they are kept six months before being drawn off and bottled. Be sure you have them in your camp, on the yacht, and on your outing trips wherever you

go. They are ready and require no mixing. Simply pour over cracked ice.

For Sale by all Fancy Grocers and Dealers

G. F. HEUBLEIN & BRO.
29 BROADWAY, N. Y. HARTFORD, CONN.

We will make it easy for you to buy an OSTERMOOR Mattress. To overcome the possible fears of any doubter

We Will Send C. O. D.

to any point *East* of the Mississippi River, any OSTERMOOR you may select from size list below—if you don't like it, simply refuse to accept it after examination. **We pay all express charges** and take all risk. Our 30 nights' free trial should calm the fears of buyers elsewhere.

The sale of more than

10000

OSTERMOORS

means that the magazine readers are growing wiser and now realize that no article could be as extensively and consistently advertised for so long a time if it were not genuinely good. The OSTERMOOR Mattress has reached that point in the appreciation of the people where it cannot be said to have any competition.

30 Nights' Free Trial

Sleep on the OSTERMOOR thirty nights free and if it is not even all you have hoped for, if you don't believe it to be the equal in cleanliness, durability and comfort of any \$50. hair mattress ever made, you can get your money back by return mail—"no questions asked."

2 feet 6 inches wide, 30 lbs. **\$8.35**
25 lbs.
3 feet wide, 30 lbs. **10.00**
3 feet 6 inches wide, 35 lbs. **11.70**
4 feet wide, 40 lbs. **13.35**
4 feet 6 inches wide, 45 lbs. **15.00**

All 6 feet 3 inches long.

Express Charges Prepaid.

In two parts, 50 cents extra. Special sizes at special prices.

Send for Book Mailed FREE

Our 96-page illuminated book, "The Test of Time," treats exhaustively the mattress question, and gives scores of letters giving unanswerable statements of praise from prominent persons fully qualified to make them. It also describes and beautifully illustrates OSTERMOOR Cushions and Pillows for Window Seats, Cozy Corners and Easy Chairs; Boat Cushions, Church Cushions. It is an encyclopædia of comfort and good taste—may we send it? Your name on a postal will do. Please send for it to-day, lest you forget.

Church Cushions

We have cushioned 25,000 Churches. We make and renovate quicker and cheaper than you imagine.

Old cushions taken in exchange.

Now is the time to make plans and get estimates for renovation during Spring and Summer.

State your needs and send for our handsome book, "Church Cushions"—mailed free.

Look Out! Dealers are trying to sell the "just as good kind." Ask to see the name "OSTERMOOR" and our trade-mark label, sewn on the end. Show them you can't and won't be fooled. It's not *Felt* if it's not an *Ostermoor*. Mattresses expressed, prepaid by us, same day check is received. Estimates on cushions and samples of coverings by return mail.

OSTERMOOR & COMPANY, 114 Elizabeth Street, New York

Canadian Agency: The Alaska Feather and Down Co., Ltd., Montreal

GOING into CAMP?

If so, you will need

A TENT

You can get one big enough for 4 men and their camp outfit, by sending me

8 Yearly Subscriptions to RECREATION

at \$1 each. You can get another tent big enough for 6 men by sending me

10 YEARLY SUBSCRIPTIONS

at \$1 each.

Why pay out money for a tent when you can make your friends pay for it?

Sail in and fit yourself for your summer vacation.

This is a great opportunity, and will hold good for only a few weeks.

Sample copies of RECREATION for use in canvassing furnished on application.



No. 12.—CANOPY SEAT, from 4 to 8 feet long, seats on both sides. Can be shipped in sections and easily adjusted by a carpenter.

Anything that can be built of natural wood

RUSTIC

Architect and Builder

I build Rustic Work of all kinds from the best seasoned red cedar, including

- | | |
|---------------------------|---------------------------|
| <i>Automobile Houses</i> | <i>Well Houses</i> |
| <i>(20 designs)</i> | <i>Porches</i> |
| <i>Log Cabins</i> | <i>Bird Houses</i> |
| <i>Boat Houses</i> | <i>Horse Blocks</i> |
| <i>Bath Houses</i> | <i>Roof Gardens</i> |
| <i>Summer Houses</i> | <i>Beer Gardens</i> |
| <i>Fences</i> | <i>Wineroom Furniture</i> |
| <i>Bridges</i> | <i>Vases</i> |
| <i>Gateways</i> | <i>Flower Stands and</i> |
| <i>Chairs and Settles</i> | <i>Lawn Furniture</i> |
| <i>Tree Seats</i> | <i>of all kinds</i> |

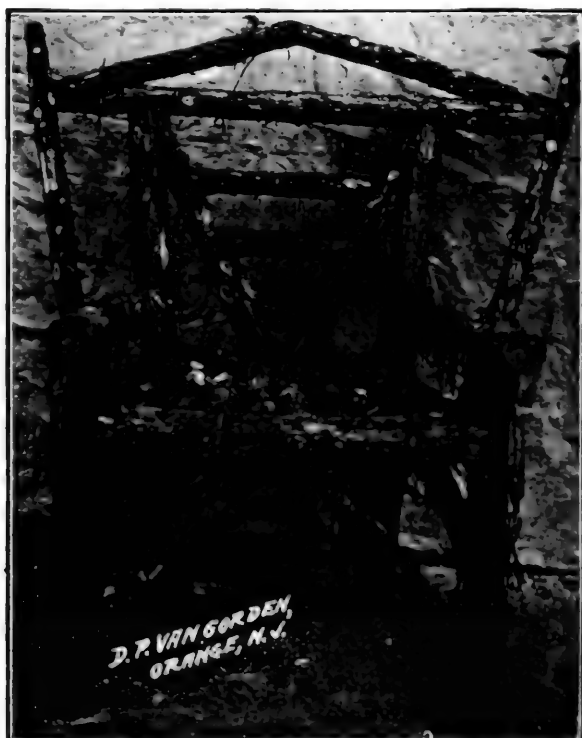

No. 16.—RUSTIC CHAIR, made of the best red cedar. Price \$4.00.

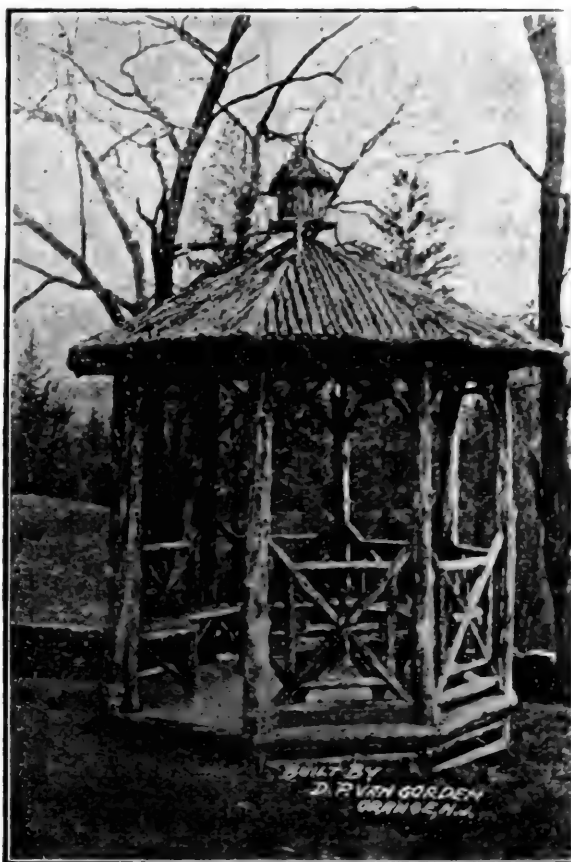

No. 9.—RUSTIC SUMMERHOUSE (9 feet). Constructed of best red cedar, with or without seats; table built in center if desired; will stand the weather and last for years.

The larger work is built in sections for convenient shipment, and may be quickly set up by any one handy with tools.

I build from plans furnished, or will furnish plans with estimates. You will find my prices right, and the work of the very best. Representatives will call upon request.

SEND FOR ILLUSTRATED CATALOGUE

D. P.
VAN GORDEN

P. O. BOX 971, ORANGE, N. J.
Opposite D. & L. R. R. Depot

MY WORK SPEAKS FOR ITSELF



No. 3.—AUTOMOBILE HOUSE on Howard Gould's Estate, Sand Point, L. I. This house is suitable for either high or low site, as shown. Special designs furnished to suit your grounds free of charge. Built of best red cedar.

When you move, take your house with you.



This is dead easy in these days of portable houses. You can spend this summer on the sea shore, next summer in the mountains, the following summer in the Wilderness of Maine, and always have a good, substantial, portable house to live in. Easily taken down, cheaply transported, easily erected. Neat, cosy and inexpensive. Two men with a hammer, a screw driver and a few screws can take down or put up one of these houses in two hours.

Send for illustrated circular which tells the whole story, and mention RECREATION

Springfield Moulding Works
SPRINGFIELD, MASS.

DO YOU WISH TO IMPROVE YOUR SHOOTING? IF IT IS AS GOOD AS IT CAN BE, DO YOU WISH TO KEEP IT SO? IN EITHER CASE, THE J. C. HAND TRAP WILL BRING WITHIN YOUR REACH THE FULL ADVANTAGE OF A SHOOTING RANGE. THESE TRAPS WILL SUCCESSFULLY THROW ANY OF THE CLAY TARGETS NOW IN USE, GIVING A LIFE LIKE REPRESENTATION OF A BIRD IN FLIGHT. I WILL SEND YOU A J. C. HAND TRAP FOR 5 YEARLY SUBSCRIPTIONS TO RECREATION. SEND IN YOUR CLUB NOW, AND IMPROVE ON YOUR SHOOTING.

The Poco "C" camera, from the Rochester Optical and Camera Company, arrived a short time ago. It is the best made and most compact camera I ever saw, and I can take better pictures with it than I can with my large one. I sincerely thank you for such a valuable premium.

Charles A. Rector, Scotia, N. Y.

I received the Bristol steel rod as a premium for 5 subscribers to RECREATION. Tried it yesterday. Caught 4 salmon. It handled them nicely and is O.K. in every respect.

A. F. Greiff, Milton, Pa.

Received the Brownie rifle and find it a beauty in every respect. Am much pleased with its accurate shooting qualities.

Newton L. Clark, Brookfield, N. Y.

The Laughlin fountain pen arrived O.K. It is a fine premium for only 2 subscriptions. I am much pleased with it.

R. Kershaw, Hebronville, Mass.

I have been taking your magazine 2 years, and find it the best book on field and stream I have ever read.

Milton F. Long, W. Philadelphia, Pa.

RECREATION is the best magazine that was ever published.

Ralph H. Oliver, Glens Ferry, Idaho.

RECREATION is the best thing of the kind I ever read. H. D. Stevens, Tioga, Pa.

Bandmen Attention!



DO YOU KNOW

that we are selling high grade band instruments at prices one-third to one-half lower than other dealers can make you?

CORNETS from \$5.80 to \$23.95

and our splendid line of Imperial Band Instruments at prices 30 per cent lower than any other dealer can make.

SEND FOR OUR NEW SPECIAL BAND CATALOGUE

which illustrates a full line of drums, clarionets, flutes and saxophones, as well as our three large lines of brass instruments and fully explains how

WE ARE ABLE TO MAKE SUCH LOW PRICES.

Our booklet, "How to Buy Band Instruments" is full of valuable pointers. Send for it. It is free.

SEARS, ROEBUCK & CO.,

Dept. B2.

CHICAGO.

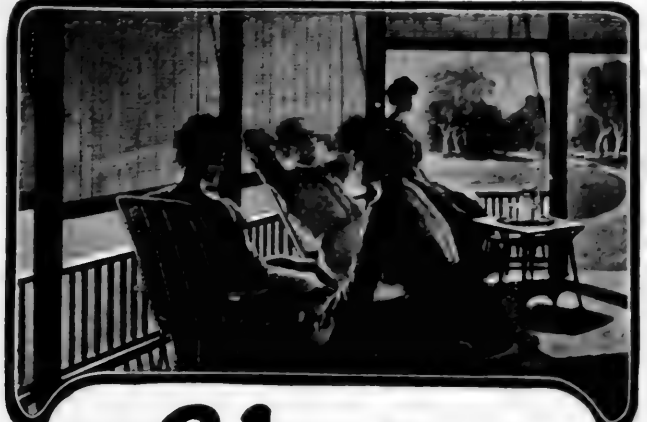

Vudor PORCH SHADES

are made of Linden Fibre, in different colors to match the woodwork of your house, and in various sizes to fit your porch. They shut out the sun and at the same time let in the air, making the porch a cool, cozy and comfortable room on warm summer days. They screen the porch from the gaze of passers-by, while allowing you an unobstructed view. Cost \$2.00 and upwards.

Write today for our booklet, "Cosy Nooks."
Hough Shade Corporation, 24 McKey Blvd., Janesville, Wis.

SOMETHING ENTIRELY NEW

A

Solid
Comfort
and very
Handsome.
For
Inside
or
Outside.

Hammock

That's Made Right

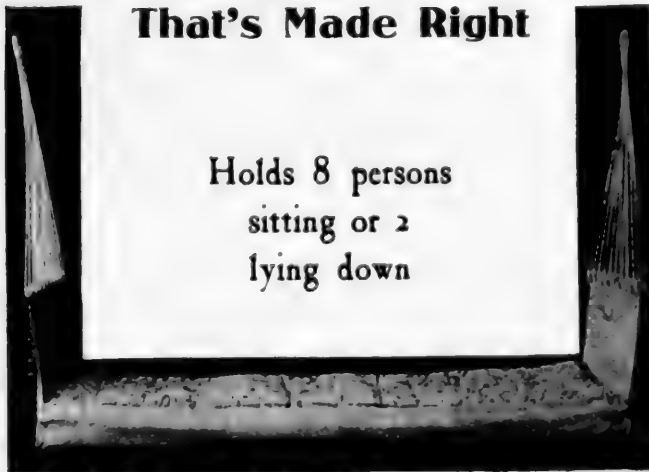

Holds 8 persons
sitting or 2
lying down

Is made
for those
who want
something
fine.
Will
wear for
years.

Fine Cotton Filled Mattress and Handsome Cover

Queen Hammock Company

174 W. North St., Kalamazoo, Mich.



Banner Rubber Coat

Pattern No. 28

"Just what I want, and the only coat I ever found that would *really* shed rain."—

F. A. KNIGHTS, M.D.

Absolutely waterproof, weight $4\frac{3}{4}$ lbs. Sent express paid in U. S. on receipt of \$5. Sizes 36 to 46 inches (breast). Length 52 inches

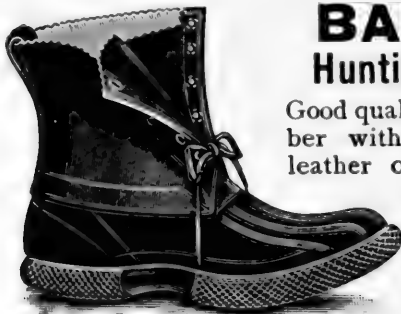

BANNER Hunting Shoes

Good quality ribbed rubber with top of best leather or water-proof wool lined brown duck. Excellent for wet grass, marsh or snow

Sent express paid in U. S. on receipt of \$3.50.

Northern Rubber Co. ^{Box} P 336 St. Paul, Minn.

Avoid Wrinkles by Using



A Stallman Dresser Trunk

KEEPS YOUR CLOTHING
FLAT AND SMOOTH

Everything in reach. No heavy trays, but light, easy running drawers. Holds as much and costs no more than a good box trunk. Hand riveted, almost indestructible. Once tried, always recommended. Sent C. O. D., privilege examination. 2c stamp for catalogue, Mention RECREATION.

F. A. STALLMAN

87 W. Spring St.

Columbus, O.

THE STORY OF A DOG.

H. H. E.

At my feet it lies, quiet, cosy, warm. All see in it a mere tanned dog skin, but to me it holds many a golden memory of happy days. My friend, Chas. York, wrote me, "I send you to-day a dog that I believe will prove a good one." Presently a box was brought to my door by the American Express man, who said. "There, Mr. E——, I have brought you a nice, new dog." He had brought me one a few months before from Philadelphia, an Irish setter, that had all the faults of his race and none of its virtues. I felt relieved when at last he went the way of all the earth. I tore the slats from the new box and took out the prettiest Llewellyn I had seen for many a year.

I named him Turk, and he became part of the household and grew in our affections. At 6 months he stood his first woodcock; at 8, his first grouse; at 13, his first quail. From that time until death came to him he never neglected duty.

One morning we started out for woodcock, and when we came to the chaparral the dog went and soon froze. I flushed my bird. Bang! went my gun, and on flew the bird. Soon another point was made, another flush, another shot and miss. Ten such chances, 10 misses, and Turk came out of the brush, dropped on his haunches before me and looked up into my face, as if to say, "You cannot shoot." Then he turned and started for home. I whistled, I called, but he kept right on. I tried to tramp up the birds, but found I could not, and, finally thinking the dog had more sense than I had, I returned home. As I entered the house the dog came out from under the porch wagging his tail, as if to say, "You won't whip me, will you?" I spoke to him kindly, and he danced around.

Early next morning we went to the same ground and soon the dog came to a point. "Steady, steady!" Whir! Bang! "Go, fetch." In came the dog wagging his tail with a timber-doodle in his mouth. So on through the day, anywhere, everywhere the dog would go, so delighted was he. That day there was no sneaking home ashamed of his master.

When old and blind, and one of his sons had taken his father's place, Turk would, when he heard us making preparations to hunt, raise his sightless eyes to our faces and beg to go with us. I would sometimes take him along. He would set off on a trot, only to bump his head against a tree or stump. Then I would take him to the carriage and lay him there, and if I took a bird and put it near his nose he seemed content.

Poor old fellow, I sit to-night with my feet on your glossy hair and think of you somewhere enjoying your well earned rest Peace to you!

To-night I see again the hill and dell, the marsh and field and the old dog making game and standing at point. I close my eyes and hear the whir-r-r of wings.



PRESIDENT SUSPENDERS

The
"Lightweight"

Only 2 Oz.

For Summer Wear and Particular
Dressers.

Same comfort, style and service. Same guarantee of
"Absolute satisfaction, a new pair or your money back."
50c. and \$1.00, at stores or by mail, postpaid.

THE C. A. EDGARTON MFG. CO.
Box 311, Shirley,
Mass.



THE TRUCEKY.

When the Jap and the Russian
Arranged a discussion,
To settle on terms of peace,
The language they uttered
Was sputtered and spluttered,
In words that resembled these:

"My hatsky I doffsky,"
The Russian began,
"I takesky it offsky
To greetsky Jap."

"I'm glad Yokohama,"
The Jap said, "to Tokio,
And I re-Fusiyama
To cover my kokio."

"Pray pardon hysterevitch,"
Said Russy, "my routsk
Lay all through my Siberevitch,
I froze my earkoutsk."

"I gladly ex-Kiushiu"—
'Twas the Jappy who said so,
"Though you're not in Jap 'Who's Who,'
At least you're not Yezo."
Said the Russ, "Shall we take just one
drinksy?"
And the Jap asked, "What will you
takaki?"

So the Russ had a vodka of inski
And the Jap took an egg Nagasaki.
Then each of them smoked a cigarski.
Then there, my friends, you are areski.
—Boston Traveler.

Are You an
Amateur
Photographer?



If so would you like a Camera
that will photograph

A whole range of mountains
A whole sweep of river
A whole army
A whole fleet of ships
A whole city

Or any other vast stretch of scenery or moving
objects? THE SWING LENS DOES IT

The **Al Vista**

is the thing. It lists at \$30

One of the greatest inventions of the age.
Given as a premium for 12 subscriptions.

For particulars address

RECREATION

23 West 24th Street

NEW YORK CITY



"Southwestern Limited"

The most popular train over the most popular and comfortable route to the

World's Fair - St. Louis

each way daily, between New York, Boston, Buffalo and St. Louis, over the

Lake Shore & Michigan Southern Railway

In connection with the New York Central and Boston & Albany roads east of Buffalo and the Big Four Route west of Cleveland, O.

Splendidly equipped with latest Pullman Sleeping Cars, Buffet Library Cars, Dining Car serving all meals enroute, and latest improved Day Car Service.

IMPORTANT.—To assist in arranging your trip get a copy of our book about the World's Fair, containing a complete colored map of grounds and other useful matter; also book entitled "List of Hotels, Boarding and Rooming Houses in St. Louis," with rates, etc., and "Book of Trains." Above sent to any address for four cents postage to cover cost mailing.

A. J. SMITH,
Gen. Passenger and Ticket Agent, Cleveland, O.



"The Nation's pleasure ground and sanitarium."
—David Bennett Hill.

THE ADIRONDACK MOUNTAINS

The lakes and streams in the Adirondack Mountains are full of fish; the woods are inviting, the air is filled with health, and the nights are cool and restful. If you visit this region once, you will go there again. An answer to almost any question in regard to the Adirondacks will be found in No. 20 of the "Four-Track Series." "The Adirondack Mountains and How to Reach Them," issued by the

NEW YORK CENTRAL

A copy will be mailed free on receipt of a two-cent stamp by George H. Daniels, General Passenger Agent, Grand Central Station, New York.

Guide Book

"In the Maine Woods"

PUBLISHED BY THE

Bangor & Aroostook Rail Road

A BOOK of nearly 200 pages, descriptive of the fishing, camping, canoeing, etc., to be enjoyed in the great northern Maine woods. Profusely illustrated in half-tone and colors.

Copy mailed for 10c in stamps.
Mention RECREATION.

C. C. Brown, G. P. & T. A.
BANGOR, MAINE

"Wonderland 1904"

Published by the **Northern Pacific** and sent by Chas. S. Fee, St. Paul, Minn., to any address for six cents—the postage—describes the **Hunting and Fishing** in the Northwest; shows what vast quantities of **Lignite Coal**, the poor man's fuel, underlie western North Dakota and how rapidly and easily it is now mined; has a long chapter on **Yellowstone Park** and the reduced rates now in effect and the many improvements made by the Government; recounts what others say of the N. P. R's Crack Train the "**North Coast Limited**"; tells about **Irrigation** in the **Yellowstone** and **Yakima** valleys, the two largest irrigable valleys in the **Northwest**, and deals with some phases of the renowned exploration of **Lewis and Clark** across the continent 100 years ago. The book is descriptive, historical, wholesome, and good for pastime reading and for future reference. Suitable for office, library, school and class room, travel and vacation.

Only Six Cents—Send for It

An Ideal Sea Trip

Offered by the

RED CROSS LINE



A CHARMING daylight sail through **Long Island, Vineyard and Nantucket Sounds.** Fine view of picturesque **Nova Scotia** and of the bold, rugged **Newfoundland Coast.** A two weeks' cruise at one-quarter the cost of going to Europe and a greater change of air and scene. Steamers sail weekly, making the round trip from New York to St. Johns and return in thirteen days and there can be no more delightful ocean voyage for those who want rest and sea air. The steamers remain in Halifax one day, going and returning, and two days in St. Johns, thus giving passengers an opportunity to visit these beautiful and interesting cities and surrounding country. The cost is low and the accommodation and service the very best. (Stop-over privileges allowed.) For full information, apply to Mention RECREATION when writing.

BOWRING & COMPANY, 17 State St., NEW YORK

THE TOURIST ROUTE

TO

**New Orleans, Texas, Mexico
and California.**

THE NORFOLK & WESTERN RY.

OFFERS THE CHOICE OF THE

New York & New Orleans Short Line

OR THE

Famous Shenandoah Valley Route

Excursion tickets now on sale at greatly reduced rates, permitting stop-overs at Washington, Luray Caverns, Natural Bridge, Chattanooga, Lookout Mountain, Birmingham, New Orleans and other interesting points.

Address.

W. B. BEVILL, G. P. A. **L. J. ELLIS, E. P. A.**
Roanoke, Va. **398 Broadway, N.Y.**

C. P. GAITHER, N. E. A.
112 Summer Street, Boston, Mass.

51x

NORTHERN MICHIGAN Trout Fishing

Every fisherman wants to know where to catch Brook Trout.

The Grand Rapids & Indiana Railway

(The Fishing Line)

issues an illustrated booklet which contains list of the best streams and lakes in Michigan. If interested send for

"Where To Go Fishing."

C. L. LOCKWOOD,

General Passenger Agent,

GRAND RAPIDS, MICH.



Send 2 cents for "Michigan in Summer," a book full of photographs of Northern Michigan Resorts.

SEASHORE, LAKE *and* MOUNTAIN Resorts of EASTERN & NORTHERN NEW ENGLAND *and* the MARITIME PROVINCES

Illustrated descriptive pamphlets (containing complete maps) have been issued under the following titles, and will be mailed upon receipt of 2¢ in stamps for each book.

*All Along Shore
Lakes and Streams,
Fishing and Hunting,
Among the Mountains,*

*Southeast New Hampshire Merrimack Valley,
Southwest New Hampshire Lake Sunapee,
Valley of the Connecticut and Northern Vermont, Lake Memphremagog,
The Hoosac Country and Deerfield Valley,
The Monadnock Region,
Central Massachusetts.*

SUMMER TOURIST BOOK

GIVING LIST OF TOURS AND RATES, HOTEL AND BOARDING HOUSE LIST,
AND OTHER VALUABLE INFORMATION, FREE.

COLORED BIRD'S EYE VIEW From MT. WASHINGTON
COLORED BIRD'S EYE VIEW of LAKE WINNIPESAUKEE

SENT ON RECEIPT OF 6¢ FOR EACH.

Reached by the

Boston AND Maine RAILROAD.

FOR ALL PUBLICATIONS APPLY TO
PASSENGER DEPARTMENT, B.&M.R.R.
BOSTON, MASS.

D. J. FLANDERS, Genl. Pass & Ticket Agt.

Portfolios:

NEW ENGLAND
LAKES.

RIVERS OF
NEW ENGLAND.

MOUNTAINS OF
NEW ENGLAND

SEASHORE OF
NEW ENGLAND.

PICTURESQUE
NEW ENGLAND.
HISTORIC — MISCELLANEOUS

THE CHARLES RIVER
TO THE HUDSON.

Will be sent upon receipt of 6 cents
for each book.

The Ruisseaumont

will open June 1st, and remain open until October 1st. The twelve cottages connected with the hotel can be engaged for the season and no housekeeping. The hotel is located ideally on the shores of LAKE PLACID, which is one of the finest spots in the ADIRONDACKS.

T. Edmund Krumbholz,
Lake Placid, N. Y.

BIG INDIAN

TROUT AND GAME PRESERVE

Big Indian Ulster Co., New York

Brook Trout Fry, Yearlings and all sizes of large trout for stocking purposes and the table on hand.

All inquiries cheerfully answered.
Mention RECREATION.

ADIRONDACKS

CAMP MOHAWK and Cottages

Fourth Lake of the Fulton Chain. Patronized largely by families and parties of friends. Two handsome new cottages have been added this spring, which have very large rooms, fireplaces and baths. Write for booklet.

Mention RECREATION.

MRS. H. H. LONGSTAFF, Old Forge, N. Y.

A. Passey, a range rider, was arrested near Butte, Mont., some time ago by Deputy Game Warden Henry Avare, on a charge of selling venison. When taken into court Passey demanded a jury trial and the jury was impaneled. After the evidence was heard, these solid men brought in a verdict fixing Passey's punishment at 60 days in jail. It is probable that Passey wishes now he had left the question to the tender mercies of the court.

I received the Poco camera in good condition, and thank you for it. It is a fine machine and well worth the subscriptions. I'm glad to find one magazine that gives the game hogs the roasting they need.

R. S. Davis, Manitou, Colo.

I received the Bristol steel rod. Thank you for it. It is the finest rod I ever owned.

W. T. Parsons, Debray, Mich.

Montana Copper Mines: I have some very promising prospects in Northwestern Montana carrying gold, silver and copper values. Would sell outright, bond or give an interest to secure capital to develop property.

If you are interested, it would pay you to write me.

Sidney M. Logan, Kalispell, Montana.

Satisfactory references furnished.



IN THE ADIRONDACKS—The New Hermitage At Lake Bonaparte, New York,

Once the property of King Joseph Bonaparte, and named in his honor.

The hotel has all the modern improvements and accessories. Broad verandas, wide roomy halls, large open fire-places, reading rooms, billiard rooms, telephone, daily mail.

Guests have the opportunity of enjoying delightful rowing, canoeing, bathing. The finest fishing in the Adirondacks, Croquet, Tennis.

A park containing 800 acres; beautiful walks and drives.

Handsomely illustrated book, giving full information, sent on request. Mention *Recreation*.

DAVID SCANLIN, Proprietor, Bonaparte, New York.

“At the Gateway of the Adirondacks.”

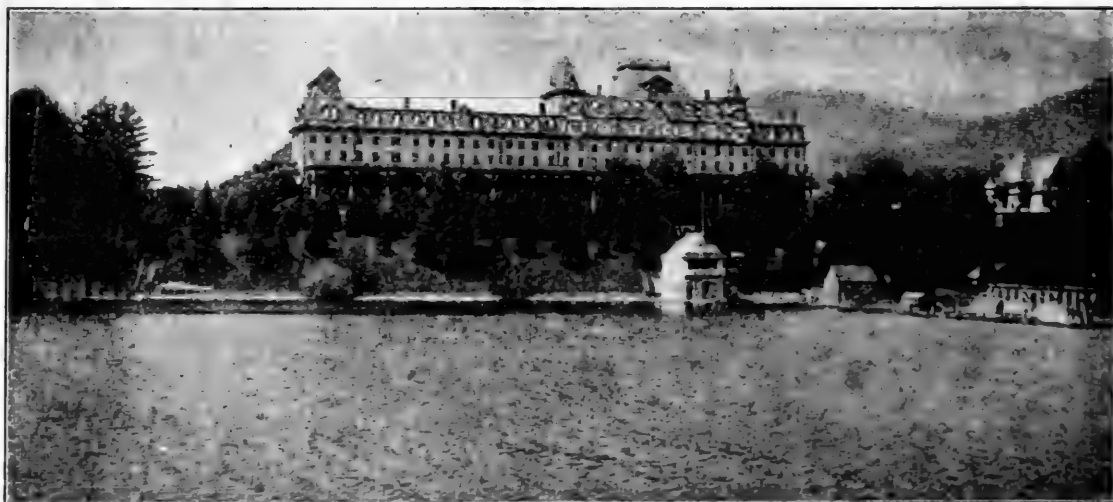

THE NEW Fort William Henry Hotel

One hour north of Saratoga Springs

Lake George, New York

Owned by the Hudson Valley Railroad Company. Hourly trolley service between Lake George and Saratoga. Situated in a delightful wooded park on the shores of the most beautiful of American lakes. Every modern improvement; hotel elaborately refitted and refurnished; perfect fire safety equipment; modern plumbing; boating; bathing; golf; fishing; charming drives.

W. W. BROWN,
MANAGER

15 years with Sagamore Hotel, Lake George

OPEN JUNE TO OCTOBER

From "Macey" to You
Grand Rapids, Mich.

We save you from 25% to 40% on fine Office and Library Furniture. We manufacture the goods we sell. We guarantee quality and prices satisfactory.



No. 10 H Office Desk

48 in. long by 30 in. wide; with file boxes and letter files complete as illustrated. Quarter-sawed oak front; balance of desk plain oak golden polish finish. Price **\$19.80**

Other roll top desks up to \$300.00. Ask for desk catalogue No. 2—mailed free.

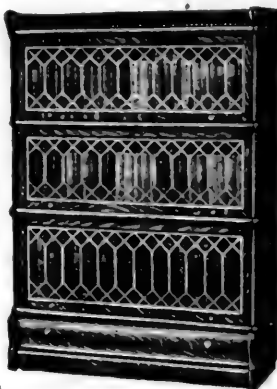

Sectional Bookcase

49 in. high; 34 in. wide; 9½ in. deep inside. Quarter sawed oak art glass doors, drawer base, **\$18.25**

Plain glass, no drawer—\$13.50. Ask for catalogue No. 1—mailed free.

We prepay freight east of Mississippi River and north of Tennessee (points beyond on equal basis).

THE FRED MACEY CO., Ltd., GRAND RAPIDS, MICH.
Dept. LL3, 1300-1320 Division St.

AIR BRUSH



FOR ART WORK.

We are making and selling the best Art Tool in use. Applies color by jet of air, enabling the artist to do better work and save time. No studio complete without it. Circulars free. Mention RECREATION. Address

Air Brush Mfg. Co.

126 Nassau St., Rockford, Ill., U. S. A.

Please accept my thanks for the Korona camera which you sent me. On trial it proves far superior to my expectations. Your premiums are certainly worth working for.

Wm. C. Ewing, Ft. Wayne, Ind.

RECREATION grows more interesting each issue. E. T. Tremaine, Brockton, Mass.

NOW DEPOSITED IN THE BANK

\$75,000.00

IN CASH GIVEN AWAY.

To arouse interest in, and to advertise the **GREAT ST. LOUIS WORLD'S FAIR**, this enormous sum will be distributed. Full information will be sent you **ABSOLUTELY FREE**. Just send your name and address on a postal card and we will send you full particulars.

World's Fair Contest Co.,

108 N. 8th Street
St. Louis, Mo.

Sent on Approval

TO RESPONSIBLE PEOPLE

Laughlin

FOUNTAIN PEN

Guaranteed Finest Grade 14k. **SOLID GOLD PEN.**

To test the merits of **RECREATION**

as an advertising medium we offer your choice of

These Two Popular Styles For Only **\$1.00** Postpaid to any Address

(By registered mail, 8c. extra)

Holder is made of finest quality hard rubber, in four simple parts, fitted with very highest grade, large size 14k. gold pen, any flexibility desired—in feeding device perfect.

Either Style—**RICHLY GOLD MOUNTED** for presentation purposes, \$1.00 extra.

Grand Special Offer

You may try the pen a week; if you do not find it as represented, fully as fine a value as you can secure for three times the price in any other make, if not entirely satisfactory in every respect, return it and we will send you \$1.10 for it, the extra 10c. is for your trouble in writing us and to show our confidence in the Laughlin Pen—(Not one customer in 5,000 has asked for his money back.)

Lay this RECREATION Down and Write NOW.

Safety Pocket Pen Holder sent free of charge with each Pen

ADDRESS :

Laughlin Mfg. Co.

424 Griswold St., DETROIT, MICH.



BETTY ZANE

The Heroine of Wheeling



BETTY

AN historical romance—
thrillingly interesting
from beginning to
end. A true story of the
struggle for independence and
the siege of Fort Henry,
September 11, 1782, told by
a descendant of the Zanes who
bore such an important part
in the events of that period.

A TRUE STORY

Illustrated in India Tint

\$1.50

By

P. ZANE GREY

OPINIONS OF THE PRESS

New York Sun—"The incidents of pioneer life would excite interest even if they were less well handled."

New York Times—"Entertaining reading."

Syracuse Herald—"Has handled his subject well."

Southern Star (Atlanta)—"It has the life, the coloring, the very breath of those pioneer days."

Recreation—"Recounts vividly the perils, the hardships and the privations of the sturdy pioneers."

Public Opinion—"Written primarily for the benefit of the Revolutionary Daughters Societies, will interest others equally."

Brooklyn Daily Eagle—"One welcomes most cordially the appearance of a Fenimore Cooper frontier story which is told without melodramatic exaggeration, without tiresome prolixity (Cooper's fatal fault), and with a just and well poised admixture of history and romance."

Zanesville Daily Courier—"Every school girl knows and loves Betty Zane, the heroine of the beleaguered garrison at Wheeling, long, long ago. Dr. Grey has portrayed the real Betty Zane; and has given us the real thing in pioneer life."



FORT HENRY

PUBLISHED BY

CHARLES FRANCIS PRESS

30-32 WEST THIRTEENTH STREET, NEW YORK CITY

SOME RARE OPPORTUNITIES

These goods are all new, and will be shipped direct from factory. Prices named are those at which manufacturers and dealers usually sell. Here is a good chance to get

A Book, a Gun, a Camera
A Sleeping Bag, a Fishing Rod
A Reel, a Tent, } FREE OF COST

Subscriptions need not all be sent at once. They may be sent in installments as taken and credit will be given on account. When the required number is obtained the premium earned will be shipped.

TO ANY PERSON SENDING ME

TWO new yearly subscriptions to **RECREATION** at \$1 each, I will send a copy of *Hunting in the Great West*, cloth; or an Ingersoll Watch or Cyclometer, listed at \$1; or a Recreation Waterproof Match Box, made by W. L. Marble and listed at 50c; or a Shakespeare Revolution Bait listed at 75c; or a Laughlin Fountain Pen; or a dozen Trout Flies, assorted, listed at \$1; or a pair of Attachable Eyeglass Temples, gold-plated, made by Gall & Lembke; or one Rifle Wick Plug, made by Hemm & Woodward, Sidney, Ohio, 30 caliber to 50 caliber, or Shotgun Wick Plug, 20 gauge up to 10 gauge; or a pair of chrome tanned horsehide hunting and driving gloves, listed at \$1.50, made by J. P. Luther Glove Co.

THREE new subscriptions at \$1 each, a safety pocket ax, made by W. L. Marble and listed at \$2.50; or a dozen Bass Flies, assorted, listed at \$2; or a pair of Shotgun Wick Plugs made by Hemm & Woodward, Sidney, Ohio, 20 gauge to 10 gauge; or a Polished Buffalo Horn Gun Rack, made by E. W. Stiles; or a pair of gauntlets, for hunting and driving, ladies' size, listed at \$2.50, made by J. P. Luther Glove Co., or a Press Button Jack Knife, made by The Novelty Knife Co., and listed at \$1.

FOUR new subscriptions at \$1 each, an Ideal Hunting Knife, made by W. L. Marble and listed at \$2.50; or a 32 caliber, automatic double action revolver, made by Harrington & Richardson Arms Co.

FIVE new subscriptions at \$1 each, a copy of *Cruisings in the Cascades*, cloth; or an Ideal Hunting Knife made by W. L. Marble, and listed at \$3; or a pair of lock lever skates, made by Barney & Berry, listed at \$4.50; or a J. C. Hand trap made by the Mitchell Mfg. Co., listed at \$4; or a Bristol Steel Fishing Rod, listed at \$6, or less; or a Yawman & Erbe Automatic Reel, listed at \$6 to \$9.

SIX new subscriptions at \$1 each, a Hawk-eye Refrigerating Basket made by the Burlington Basket Co., or one dozen Eureka golf balls listed at \$4; or a Pocket Poco B 3¼ x 4¼, made by the Rochester Optical Co., listed at \$9.

SEVEN new subscriptions at \$1 each, a copy of *The Big Game of North America*, or of *The American Book of the Dog*,

cloth, or one set Lakewood golf clubs, 5 in number, listing at \$5; or a series 11F Korona Camera, made by the Gundlach Optical Co., listed at \$10.

EIGHT new subscriptions at \$1 each. A series 1, 4 x 5 Korona Camera, made by the Gundlach Optical Co., listed at \$12, or an Acme single shot gun, made by the Davenport Arms Co., and listed at \$8.

TEN new subscriptions at \$1 each, a Cut-Glass Salad Bowl, made by Higgins & Seiter, and listed at \$4.50; or a Waterproof Wall Tent 7 x 7, made by Abercrombie & Fitch, and listed at \$8; or a Rough Rider rifle telescope, made by The Malcolm Rifle Sight Mfg. Co., and listed at \$12; or a Pneumatic Camp Mattress, listed at \$18; or a pair of Opera Glasses made by Gall & Lembke and listed at \$10.

TWELVE new subscriptions at \$1 each, a Davenport Ejector Gun, listed at \$10, or a Cycle Poco No. 3, 4 x 5, made by the Rochester Optical Co., listed at \$15; or an 8 ft. folding canvas boat, made by the Life Saving Canvas Boat Co., listed at \$29.

FIFTEEN new subscriptions, \$1 each, a Shakespeare Reel, Silver Plated, listed at \$15; or a set of rabbit plates made by Higgins & Seiter, and listed at \$8; or a Field Glass made by Gall & Lembke; or a Kenwood Sleeping Bag, complete, with canvas cover, listed at \$16; or a Bulls-Eye rifle telescope, made by The Malcolm Rifle Sight Mfg. Co., and listed at \$16; or a 10 ft. special canvas boat, made by the Life Saving Canvas Boat Co., and listed at \$35; or a pair of horsehide hunting boots, listed at \$10; or a Queen Hammock, made by the King Folding Canvas Boat Co., and listed at \$15, or a Mullins Duck Boat, listed at \$20.

TWENTY new subscriptions at \$1 each, a 14-karat Gold Hunting-case Watch, with Waltham Movement, listed at \$20; or an Elita single shot gun, made by the Davenport Arms Co., and listed at \$18; or an Acme Folding Canvas Boat, No. 1, Grade A, listed at \$27; or a Queen Hammock, made by the King Folding Canvas Boat Co., and listed at \$20; or a Mullins' Bustle Ducking Boat, listed at \$27.

TWENTY-FIVE new subscriptions at \$1 each, an 11-foot King Folding Canvas Boat, listed at \$38.

THIRTY new subscriptions at \$1 each, a Waterproof Tent, 14½ x 17, made by Abercrombie & Fitch, and listed at \$25.

THIRTY-FIVE new subscriptions at \$1 each, a 14-ft. King Folding Canvas Boat listed at \$48.

FORTY new subscriptions at \$1 each, a Savage .303 Repeating Rifle; or a No. 10 Gun Cabinet, made by the West End Furniture Co., and listed at \$32.

FIFTY new subscriptions at \$1 each, a No. 20 Gun Cabinet, made by the West End Furniture Co., and listed at \$38; or a Colt Automatic Pistol, made by the Colt's Patent Fire Arms Mfg. Co., and listed at \$25.

Address, **Recreation** 23 West 24th St.
New York



FAITHFUL DOGS AND TWO FAITHFUL REMEDIES

You can't expect lively activity and strength out of a wormy dog, any more than strength in a wormy piece of wood.

Nausea, colic, pains, restlessness, fever, fits—these are all symptoms of worms, all of which disappear with the administration of

Sergeant's Sure Shot

50c. per Bottle

Or take a dog suffering with any ailment common to dogdom—Stomach out of order, Cold or Distemper, Fever, Mange and General Debility or Nervousness—he needs something that will correct the trouble at once, and then built up all the enervated organs.

The safe, sure thing that will do this are

Sergeant's Condition Pills

50c. and \$1.00 per Box

Ask your Druggist for these Dog Remedies, or your Sporting Goods man; if he hasn't them, send us the price, and we'll deliver them post-paid.

Get our handsome Dog Book and a set of Pedigree Blanks free. Send address and 3 cents to cover postage.

POLK MILLER DRUG CO., Richmond, Va.

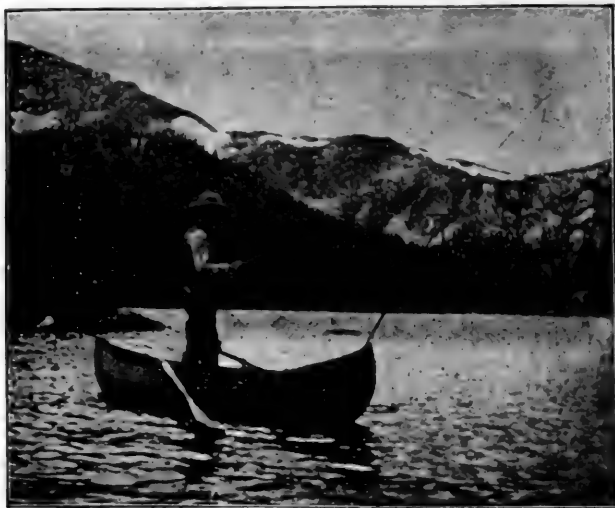

11-foot Special

used by the U. S. Navy. They are simple, wonderful. A thoroughly patented article. Beware of imitations. Made only by ourselves. *A catalog of 100 engravings and 400 testimonials sent on receipt of 6 cents.*

Bottom Boards rest on the frame, not on the canvas, ribbed longitudinally and diagonally. They are *stiffer and safer* than a Wooden Boat because the lines are fuller, and are much easier to row or paddle.

KING FOLDING CANVAS BOAT CO.

Mention RECREATION.

KALAMAZOO, MICH., U. S. A

BUILD YOUR OWN BOAT BY THE "BROOKS SYSTEM"

16 FT. LONG. Exact size PATTERNS of every piece. Complete IN-4 FT. BEAM. STRUCTIONS. Each step plainly ILLUSTRATED. Experience unnecessary. Hundreds have built this boat. PATTERNS \$5. working spare time. at a total cost of \$14.00 - Boat Patterns of all kinds and sizes up to 5 ft. at prices from \$3.00 up. We also build complete boats and knock down frames. COMBINATION LAUNCH-SAIL & ROW-BOAT. PARTICULARS FREE-25¢ brings 64 p. illustrated catalogue. set of working instructions and illustrations. BROOKS BOAT MFG. CO. STA. B BAY CITY, MICH.

Apple Automatic Sparker

For Gas Engines, Automobiles, Launches, Etc., HAS FEATURES FOUND ON NO OTHER. No batteries, no belt, no switch, no commutator troubles. Entirely enclosed, making it dirt and water proof. Easily attached. Send for complete description of this and other ignition apparatus. The Dayton Electrical Mfg. Co. 126 RIEBOLD BLDG., DAYTON, O



Morris Canvas Covered Canoes

Special Indian model for safety. Catalog on request. Mention RECREATION.

B. N. MORRIS,

Veazie, Maine

The No. 1 Korona camera you sent me as a premium for securing subscribers to RECREATION arrived yesterday. Am I pleased? Well, I guess yes! The camera is so much better than I expected that I shall try for another premium.

P. L. Bock, Highspise, Pa.

Funny! how we love our friends,
And what we'd give for them;
We sigh for them,
We'd die for them,
Until—we live with them.

—Exchange.

RECREATION is a great magazine, and you are waging a noble fight. All true sportsmen are with you, heart and soul, in your work.

L. W. Johnson, Trenton, N. J.

I am in receipt of the Laughlin fountain pen you sent me. It writes beautifully and I am much pleased with it.

Richard Dillehunt, Decatur, Ill.

EASIER TO ROW ABSOLUTELY SAFE

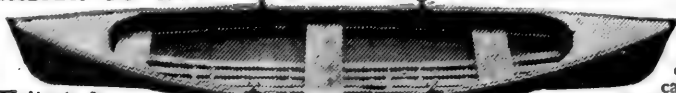

Write today for free catalogue. 15 foot boat. crated \$29

Especially valuable at summer resorts, for family boating.

Mullins Galvanized Steel Pleasure Boats

Made of steel. Practical indestructible. Air chamber each end. Cannot leak. Require no caulking. Ideal boat for family use, summer resorts, parks. Guaranteed. Will seat five persons in comfort. The modern row boat for pleasure, safety and durability.

W. H. MULLINS, 228 Depot Street, Salem, Ohio

RUSHTON

CANOES



Canoes Are Everywhere

At every summer resort, on lake or river, nowadays you will find these most graceful craft gliding back and forth. Don't waste your time envying your friends who have been wise enough to invest in a canoe, but get one for yourself, and pass your summer days on the water where it's cool, restful and refreshing.

I make scores of sizes and styles of canoes, and one of them will surely meet your requirements. Before buying any kind of a pleasure boat or canoe, investigate what I have to offer. My experience of 30 years, and my large establishment will give you the very best service.

Send for my complete Catalogue of pleasure boats, all-cedar and canvas-covered canoes, oars, paddles, sails and fittings—free for the asking.

J. H. RUSHTON, 817 Water St., Canton, N. Y.

Von Blumer—What play shall we see to-night?

Mrs. Von Blumer—Is there anything decent?

"No. We've seen all the decent plays. We've already been one night this season."—Exchange.

Get a Stick Pin Free:—To any person sending a new subscription for RECREATION, through me, I will send free, as a premium, a genuine Mexican Opal mounted in a gold filled stick pin. Don M. Harris, 43 Elberon St., E. Cleveland, Ohio.

SMALLEY

MARINE GAS ENGINES

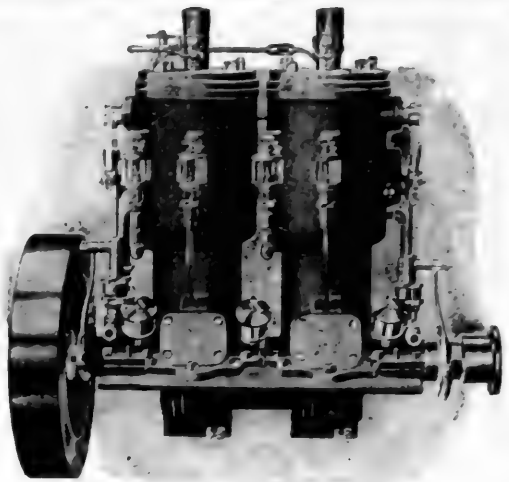

Generally acknowledged to be the most scientifically constructed, most handsomely designed and finished marine gas engine on the market. Suitable for any kind of a boat requiring from 1½ to 20 H. P. Either single or double cylinder. Our speed control, propeller equipment, igniter mechanism, lubricating arrangement and other features deserve your attention. We have the largest exclusive marine gas engine plant in the world; operating our own pattern, foundry, forge, and machine departments. Our guarantee carries with it a weight that means something.

Every engine is connected to its propeller and given an actual water test before placed in purchaser's hands.

Send 4c in stamps for 1904 catalogue.

ADDRESS DEPT. C

Smalley Motor Co., Ltd., Bay City, Mich., U. S. A.

Dr. Robert Reyburn, Dean of the Medical Department at Howard University, and the attendant physician to the late ex-President Garfield, believes in bicycling first, last, and all the time. In a recent article he said: "Bicycling has done more for the physical benefit of women than all other exercises put together, and I cordially recommend it."

"Pop, is Greenwood Cemetery a part of Brooklyn?"

"No, my boy, Brooklyn is a part of Greenwood Cemetery."—Life.

The Western Recreation Launch

ABSOLUTE LAUNCH SATISFACTION

Is contained in the "Western Recreation." It possesses those essential points, Grace, Beauty of Outline, Symmetry, Simplicity and Safety. Speed is there too if you want it. Most reasonable in first cost, most economical to maintain.

THE BEST FINISHED, HANDSOMEST, MOST RELIABLE.

We build them with either Torpedo or Semi-Elliptic Hulls, and in completeness, it is the ideal and dependable craft for both pleasure and security.

The Western Marine Engine Will please those who build their own hulls. Beautiful Art Catalog describing our Launches and Marine Engines sent upon receipt of 10c. Catalog L.

Western Launch and Engine Works, No. 12 Linn St., Mishawaka, Ind.

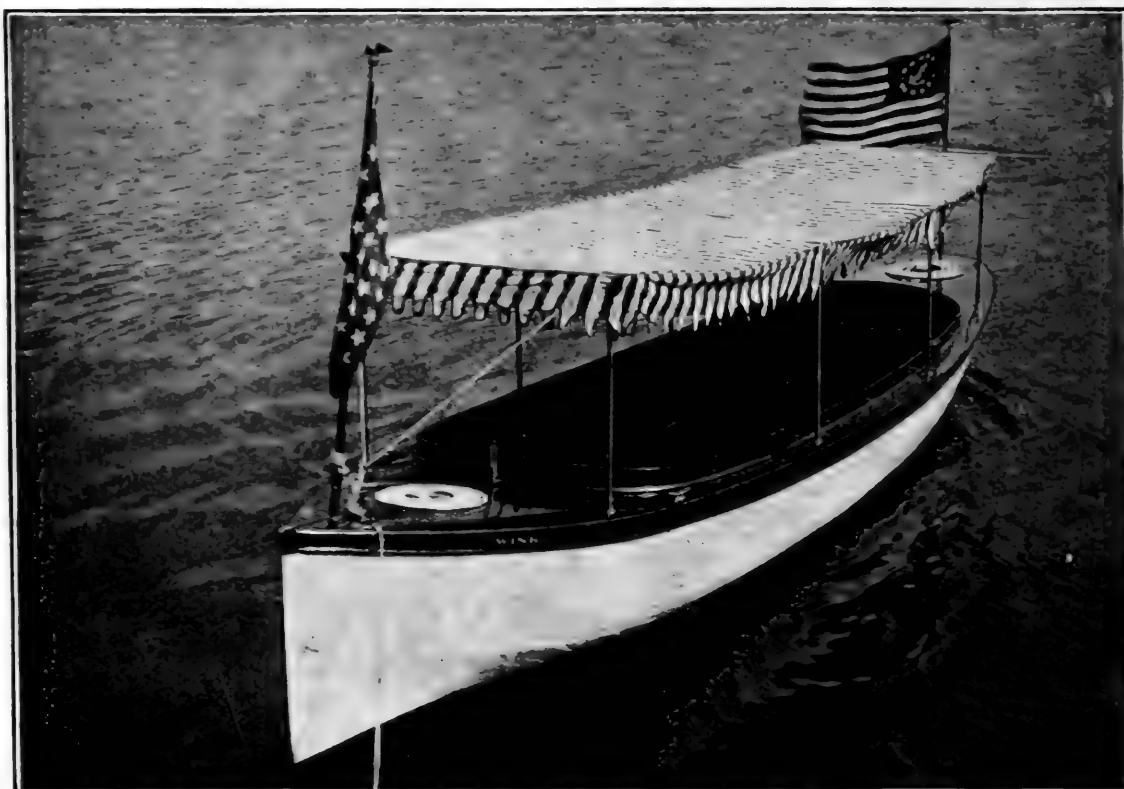

GASOLINE ENGINES and LAUNCHES UP TO DATE
 Self-Starting Jump or Break Spark Catalog Free
D. M. Tuttle Co. 10 Pine Street Canastota, N. Y.

A Press Button Hunting Knife

Is one of the best articles a hunter ever carried

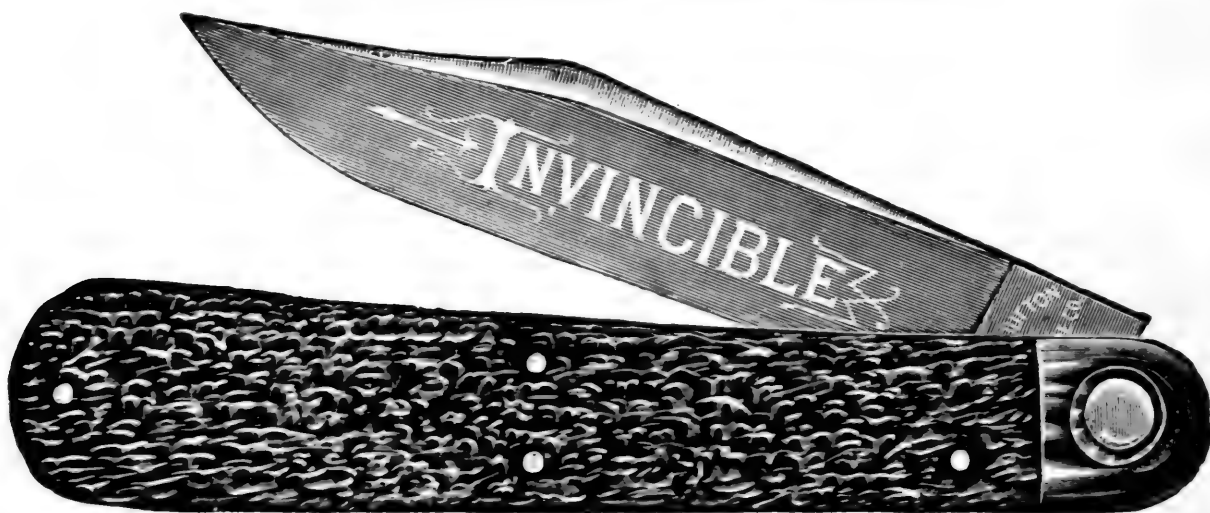

It has a 4 Inch Blade made of the Best Silver Steel

The knife cannot come open in your pocket. It cannot close on your hand when in use. It opens and closes only when

YOU PRESS THE BUTTON

If you once use one of these knives you will never use any other. You can get one as a premium for

3 YEARLY SUBSCRIPTIONS TO RECREATION

Sample Copies furnished on request.

RELIANCE

MARINE MOTORS FOUR CYCLE

LIGHT

POWERFUL

ECONOMICAL

1 to 6 Cylinders

4 to 150 horse power

Special Design *for* Auto Boats

Write for information and prices

RELIANCE MFG. CO.

City Island, N. Y. City

Gasoline and Steam
Engine Repairs

Mention RECREATION.

A stage villain was supposed, at the end of the 5th act, to plunge a knife in his heart and to die hard, rolling and kicking all over the stage. When his cue came he did plunge in the knife, but instead of dying, he lay down on the floor, crossed his legs and burst into loud, long laughter, the dagger still sticking in his breast. The audience was amazed at such conduct. The actors were stupefied. The manager, nearly beside himself, hissed from the wings in a loud whisper:

"You fool, what are you laughing at? This is your death scene."

"Death scene?" said the recumbent villain.

"I know it is, and with such a salary as you give me death comes as a happy release."—New York Tribune.



THE TEST OF TIME

has proven the superiority
of the

Iowa Marine Engine

OVER ALL OTHERS

Has record of 86,400 miles in four seasons and still in service. Send 8 cents for descriptive catalogue
Mention RECREATION.

Iowa Marine Engine
Works

BELLEVUE, IOWA.



ACME FOLDING BOAT CO., MIAMISBURG, O.

Send for catalogue of our full line of Folding Canvas Boats and Canoes, which have been adopted by Governments of United States, Canada and England. Just filled an order for U. S.

Government, who prefer our boats. Received medal and award at Chicago World's Fair. If you investigate we will get your order. Mention RECREATION.

Acme Folding Boat Company, Miamisburg, O.

A Sportman's Boat **MULLINS** "Get There" Steel Duck Boat

Price \$20—Crated on cars Salem

Endorsed by Thousands of Sportsmen. Air Chamber each end. Always ready No repairs. Send for handsome free book.

W. H. MULLINS

228 Depot Street, . . . Salem, Ohio

14
ft. long,
36-inch beam.



THE LATEST, SAFEST AND BEST CANVAS BOAT

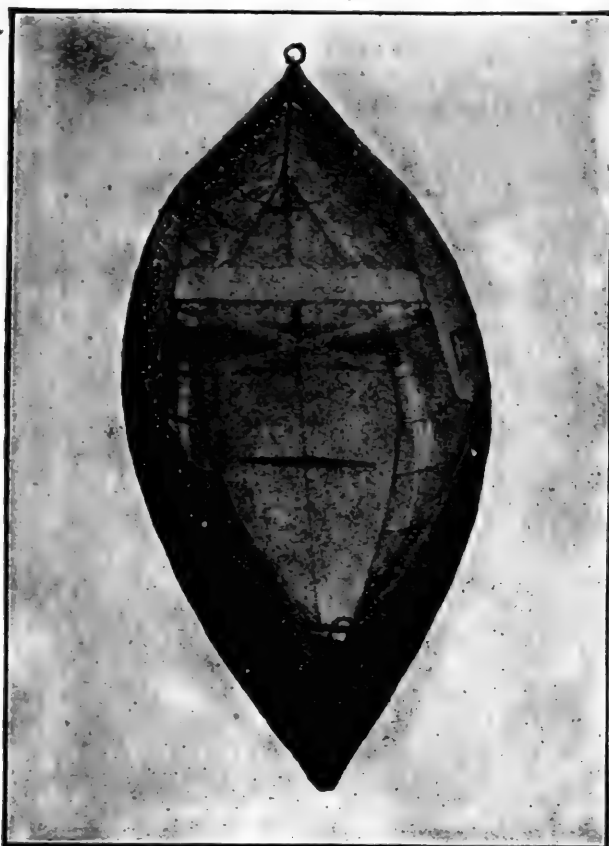

Is what we offer you. A Boat built on modern lines that will prove a pleasure to own and use. Selected materials used throughout, and it comes to you **guaranteed** the best. A handy and safe boat for fishing and shooting. Send 4 cents in stamps for catalogue and reliable testimony.

Mention RECREATION.

LIFE SAVING FOLDING CANVAS BOAT CO.
757 Portage St., Kalamazoo, Mich.



Latest patent and improved Canvas Folding Boat on the market. Puncture proof; Tempered steel frame. No bolts to remove. Folds most compact of any boat made.

MOJAVE INDIAN BEAD WORK.

For each new yearly subscription to RECREATION sent us we will send by mail, postpaid, a Beaded Watch Fob, made by the Mojave Indians. For 3 new yearly subscriptions we will send a fine Beaded Belt, 24 inches or more in length and made in beautiful design with mild color combinations. We also have other Indian work to offer for subscriptions.

State color desired; can furnish almost anything from large stock.

Mojave Indian Trading Co.,
Mellen, Mohave Co., Arizona.

IN ANSWERING ADS. PLEASE MENTION RECREATION.

NOTICE!

Readers of Recreation are **Cautioned**

against sending any money to **G. A. Henry, Jr., Hibbing, Minn.** I have reason to believe he is a fraud.

My hunting boots have arrived safe. I am much surprised and pleased with them. Every time I wear them this next season I will think of you and RECREATION. Thank you much for such a fine premium.

H. V. Potruff, M.D., Munhall, Pa.

A FEATURE OF THE WORLD'S FAIR

The Peerless
TRUSCOTT

TRUSCOTT BOAT MFG. CO.
Agents in the principal cities. **ST. JOSEPH, MICH.**

PATENTS

promptly obtained **OR NO FEE.** Trade-Marks, Caveats, Copyrights and Labels registered. **TWENTY YEARS' PRACTICE.** Highest references. Send model, sketch or photo. for free report on patentability. All business confidential. **HAND-BOOK FREE.** Explains everything. Tells How to Obtain and Sell Patents, What Inventions Will Pay, How to Get a Partner, explains best mechanical movements, and contains 300 other subjects of importance to inventors. *Address,*

H. B. WILLSON & CO. Patent Attorneys
786 F Street, N. W., WASHINGTON, D. C.

Fay & Bowen Motors & Launches

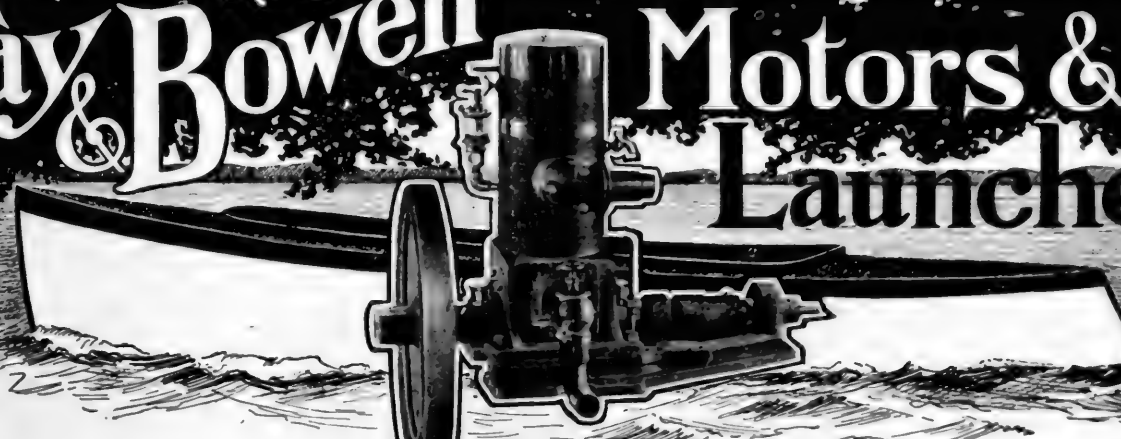

OPERATED BY GASOLINE VAPOR

The Fay & Bowen Marine Motor is a revelation to those who have used others. Reliable, safe, durable and easy to operate. Remarkable speed control. Best of all, it starts when you start it. No handle or crank is used. Our patent igniter is absolutely unique and always instant and positive in action. It is really the only perfect and satisfactory igniter.

Motors complete from 1½ to 25 actual Horse Power ready for installation.

We also build a line of the finest launches afloat, complete and with our motor installed and all ready to run. We make these in either the usual round stern model or our flat stern torpedo model in lengths from 18 to 35 feet. We can furnish large cabin launches on special order. For excellence of workmanship and beauty of finish and design our boats are unsurpassed. Ask for description of our fast torpedo outfits.

Send for Catalogue and live testimonials from satisfied customers. Our customers are our best advertisers.

FAY & BOWEN ENGINE CO. ⁷⁴ Lake St., Geneva, N. Y.

Black Squirrels:—Will send a pair of these rare and beautiful pets to any one who will send me 12 new yearly subscriptions to RECREATION. Will send a pair of Fox Squirrels for 6 new subscriptions, or a pair of Flying Squirrels for only 2 new subscriptions. Safe delivery of squirrels guaranteed to any part of U. S. or Canada. E. F. Pope, Colmesneil, Tex.

RECREATION is the best magazine ever published.

Frank H. Chase, Danbury, Conn.

Arthur R. Reynolds, M.D., Commissioner of Health for the City of Chicago, gives bicycling the credit for the great American movement toward outdoor life and open air recreation. In a published article he says: "Bicycling taught the American people the advantage of out of door life and rational exercise. Rational exercise in the open air is the best method of preventing disease by fortifying the system to resist its attack."

The girl we all like knows nothing of love, but is willing to learn.



CANOES and ROW BOATS

Canvas-covered, built of cedar, light, staunch, graceful. Made of best materials by skillful workmen. Styles for all purposes; wide range of sizes and prices. Send **Now** for free illustrated catalogue.

OLD TOWN CANOE CO., 28 Middle St., Old Town, Me

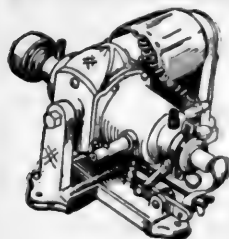

TO OWNERS OF GASOLINE ENGINES, AUTOMOBILES, LAUNCHES, Etc.

The Auto-Sparker

does away entirely with all starting and running batteries, their annoyance and expense. No belt—no switch—no batteries. Can be attached to any engine now using batteries. Fully guaranteed; write for descriptive catalog.

Motsinger Device Mfg. Co.
75 Main St., Pendleton, Ind.

18 ft. Long - 4 1/2 ft. Wide

Non-Sinkable Steel Auto-Boat \$250



Fitted with powerful Automobile, four cycle marine engine, cannot sink, cannot rust. Capacity ten to twelve people.

Nonsinkable Steel Launches, Row Boats, Sail Boats, Canoes, Duck Boats, etc.

Made from the best quality Apollo Steel—will last a lifetime. Send for catalogue. Write for agents' discount.

MICHIGAN STEEL BOAT CO., 1275 Jefferson Ave.
DETROIT, MICH., U. S. A.

The JOHNSON Trayless Tackle Box

A paragon of capacity and
Practical Convenience



Patent applied for.

No trays to spread out and spill about. Our box opens out flat like a suit case, and there is everything for Fishing literally at your finger ends.

Retail Price, \$2.00

For further information address the sole maker and mention RECREATION

Merriam Mfg. Co.
DURHAM, CONN.

Small Profits—Quick Sales

TROUT FLIES

for trial—send us



- | | | |
|-----|---|-----------------|
| 15c | for an assorted sample doz.
Regular price, 24 cents. | Quality A Flies |
| 30c | for an assorted sample doz.
Regular price, 60 cents. | Quality B Flies |
| 60c | for an assorted sample doz.
Regular price, 84 cents. | Quality C Flies |
| 60c | for an assorted dozen
Regular price 84 cents. | Bass Flies |

SPLIT BAMBOO RODS

Fly Rods 10 feet, 6 ounces **57 cents** Bait Rods 9 feet, 8 ounces

With cork grip and extra tip, in wood form

THE H. H. KIFFE CO.
523 Broadway, New York City

Catalogs of any of above goods free on application.
Mention RECREATION.

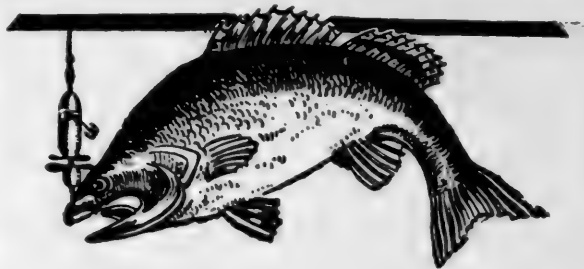

Fine Fishing

Tackle Free

I want every enthusiastic fisherman, whether amateur, beginner or professional, to have a personal knowledge of the fine points of the Shakespeare Reels and the marvelous catching qualities of the Shakespeare Baits—and to do this I propose to send to every man or woman who fishes for the real sport there is in it, one of my reels and baits for free trial on their next fishing trip. Write to-day. Send your name and address and the name and address of the leading sporting goods dealer of your city to Wm. Shakespeare, Jr., 403 Shakespeare Bldg., Kalamazoo, Mich. The Shakespeare Reel is especially designed for accurate and long-distance casting, and it is without doubt the best reel in the world, and you will say so when you see it. The metal used in the Shakespeare Reel is hard-drawn brass and the finest English Stubbs steel. Painstaking care is used to secure perfect accuracy in every detail. In beauty of design, and simplicity of construction it is unequalled. Its easy, silent running suggests perpetual motion and it is fitted with the most perfect drag and click ever invented. Words will not describe its beauty, its usefulness, nor its many advantages over all other reels. My reels and baits are for sale by all first-class dealers but I want you to see them and try them for yourself and I will send them to you direct, express prepaid, for a free trial. The Shakespeare Baits are really marvelous. With them the fisherman is sure of a good catch, no matter where the fish are, in the lake or stream. If they are in deep water, Shakespeare makes the bait that attracts them. If they are in shallow water, Shakespeare makes the bait that catches them. If they are hidden in the lily pads or moss, Shakespeare makes the bait that makes them strike. And Shakespeare offers \$100 in prizes for the photograph and authentic dimensions of the biggest large or small mouth bass caught this year. Write to-day for particulars. His little booklets, "How to Catch Bass," "Shakespeare Fine Fishing Tackle" and "The Art of Bait Casting," are free to every angler. Write to-day.



Don't suffocate yourself with fly-nets. Don't use ill-smelling pastes and heavy oils which make your face feel like sticky fly-paper.

USE PRESTO

It is colorless, has a pleasant odor, is non-poisonous and
LEAVES NO STAIN

PRESTO is guaranteed to keep mosquitoes, black flies, midges, and punkies from biting.

Presto Kills all Insects

and is invaluable as a kennel requisite, eradicates unpleasant odors and kills fleas and their larvae. No sportsman's camp is complete without a bottle of PRESTO.

Make your dealer send for it, for if you use Presto once, you will want more. Sample Can will be sent by mail for **20c** postpaid.

Presto Manufacturing Co.

Lock Box 1248

When writing mention RECREATION.

OSSINING, N. Y.

A well known actor was telling his 16 year old son, whom he considers immature for his age, that he ought to be doing something for his glory and his country.

"Why, when George Washington was your age, my son, he was surveying the estate of Lord Fairfax."

"Well, when he was as old as you, pa, he was President of the United States."—Argonaut.

I received the Korona camera sent me for securing subscribers to your unrivaled magazine, and I thank you sincerely for it. I have been slow in writing you, but meantime have given the camera a most severe test, which has proved it to be a perfect instrument.

C. W. Hanson, Lake City, Minn.



Bamboo Cane Poles

and other untrimmed rods are Novelcraft mounted for reel fishing in one-half minute. Complete set trimmings mailed **75c**, dozen **\$7.20**. Patented in United States and Canada, 1903. When writing, mention RECREATION

NOVELCRAFT MFG. CO.
Cleveland, - Ohio

Free: To anyone sending through me \$1 for 1 yearly subscription to **Recreation**, I will give a sportsman's pocket medicine case. For 2 subscriptions, a physician's pocket medicine case. Walter Lusson, Ardmore, Pa.

Our Detachable Even Spoolers



WHEN attached to a good reel make the best casting and fishing outfit on earth at about half the price of old style. They give perfect satisfaction in every case. To prevent regret later on, don't buy the wrong reel. Our free catalog (B) names reels spooler will fit. Price and description of spoolers, gun cleaners, fish scalers, ball bearing, jeweled, and steel pivot bearing reels fitted with even spooler. Our new rubber hook-shield binds hook and line securely to rod when not in use. All sorts of trouble and profanity prevented in an instant.

A. W. BISHOP & SON, PATENTEES AND MANUFACTURERS
RACINE, WIS., U. S. A.

Marble's Ideal Hunting Knives



Are hand-made throughout by experienced workmen skilled in the art of knife making. They are forged from the best razor steel, are hand tested, and fully guaranteed. Each blade is tempered with the single idea of securing an edge that will hold its keenness and which will not nick or turn when subjected to hard usage. Back of point is brought to an edge for chopping bone. The knife slides into its sheath so far that it cannot fall out.

Blades, $4\frac{1}{2}$ to 8 inches. Prices, \$2.25 to \$3.50. For sale by dealers everywhere, or direct, prepaid. Send for new 32-page catalogue, showing 18 new specialties, and mention Recreation.

Marble Safety Axe Company

Dept. A. GLADSTONE, MICH.



Burnt Work—Something Great. To persons sending new subscriptions to RECREATION through me, or sending them direct to the office to my credit, I will send the following prizes:

For 1 new yearly subscription to RECREATION I will give a neat barrel match safe mounted on an oval back, both burned and decorated, equal in value to 75 cents.

For 2 new yearly subscriptions to RECREATION I will give a 6-inch round picture frame burned and decorated with beautiful old fashioned poppies tinted with water colors. This would cost you \$1.25 at the least.

For 5 new yearly subscriptions to RECREATION I will give either a round stool 14 inches high with round upholstered top or a square stool same height with square upholstered top. These would probably cost you \$7 or \$8 finished as I finish them with designs burned in the wood and leather.

E. A. King, Pleasant Prairie, Wis.

Free: For 1 year's subscription of RECREATION, through me, will give 1 Bromide enlargement, any size up to 11 x 14 inches, inclusive, from any negative not larger than 4 x 5; or from photographs. Negatives and Photos are to be returned to the owner. Here is a rare chance to get a large Photo from your pet Negative, also RECREATION for \$1. A. F. Evarts, Meriden, Conn.

LOVE A LA MODE.

Reject me not, maid saccharine,
Nor fear, my darling prized,
In allopathic glen, unseen,
Your sweet Pasteurized head to lean
On waistcoat sterilized;
Come, talk of antitoxin love
'Neath Board of Health—y trees,
While cooes the duly licensed dove
And softly sighs, our heads above,
The disinfected breeze.

Why greet, with exclamations gruff,
My soul's despairing call?
Why gaze, in antiseptic huff,
At little specks upon my cuff,
Which were not germs at all?
Why let me not my thoughts express,
My adoration speak,
My everlasting love confess,
Whilst medicated lips I press
To fumigated cheek?

What faithless hearts have maidens fair!
'Tis of my foe you think;
You know him not! Beware, beware!
Gems lurk behind his noble air
And microbes in his wink!
Farewell, existence, worthless toy!
Farewell! at life I mock,
The wild bacilli shall destroy
My aching heart, bereft of joy,
Far, far, from Dr. Koch!

T. Ybarra in Life.

"BRISTOL" RODS

for
Black Bass

BLACK BASS—*"He is a fish that lurks close all winter, but is very pleasant and jolly after mid-April and May and in the hot months."*—ISAAC WALTON.

Get your bite—the "Bristol" will do almost all the rest. It has the necessary spring, snap, and stiffish back required in a Black Bass Rod. The most resilient material used in rod making is Steel, which makes them tough and elastic, with a rebound found in no other rod but the "Bristol."

Sold by all dealers: they will give you the benefit of reduced prices

Free Our handsome catalog "D" describing all the "Bristol" steel rods.

THE HORTON MFG. CO., Bristol, Conn. U.S.A.



"BRISTOL" RODS

for
Brook Trout



THE Bristol Steel Fishing Rod has all the good points of other rods, with many valuable and exclusive features of its own. It is all nerve and backbone. Casts a fly with fluency and precision and controls it with the course of the struggling fish.

We believe the "Bristol" can stand more use or abuse than any other rod made and is unequalled for all kinds of fishing.

Ask your dealer about the reduced prices.

FREE for the asking—our descriptive catalogue "D"

THE HORTON MFG. CO.
BRISTOL, CONN., U.S.A.

**HUNTING
CAMPING
FÊTING**

Established 1840

Geo. B. Carpenter & Co.
Makers of High Grade

**Tents, Sails, Camp
Furniture**

Folding Cots, Tables,
Chairs, Oars, Paddles,
Marine Hardware

The Largest and most Complete Stock in the U. S.

Send 4c in stamps for Tent and Camp Catalogue. or 6c in stamps for Marine Hardware Catalogue. Mention RECREATION

200, 202, 204, 206, 208 S. Water St.
CHICAGO, ILL.

**SAILING
PROSPECTING
FISHING**

**FOR
Solid Comfort
SUMMER or WINTER**

The
Best
is
the
Cheapest

Get a pair of
**Thompson-
Quimby
Hunting
Boots**

I Make the Best

All work guaranteed. I refer by permission to the Editor of RECREATION. Measurement blanks and prices on application. Mention RECREATION.

T. H. GUTHRIE
33 William St. NEWARK, N. J.

**Do you want
a Boat?**

If so, send me

15 yearly subscriptions to Recreation

and get a

Mullins' Get There Ducking Boat

or send me 20 yearly subscriptions for RECREATION and get a

Mullins' Bustle Ducking Boat

Sample copies for use in canvassing furnished on request, address

RECREATION
23 W. 24th St., New York City

Duxbak

Sportsman's Coat

Sheds Water like a Duck's Back

Positively waterproof and rain defying. Will not rustle. Made of cloth as soft and pliable as chamois. Lined throughout with same material. Treated by a process that resists a driving rain or an all day drizzle and yet permits perfect ventilation.

Waterproof qualities guaranteed throughout the life of garment. It's nearly all pockets. Double stitched throughout; re-inforced shoulder cap. Patent bellows under arm allows free arm movement with gun or rod. Full cut, well tailored and trimmed. Light tan or dead grass color.

Easy as a Sweater

Price \$5.00 express prepaid to all points east of Mississippi River. Send snug breast measure under arms. State color desired. Cloth samples free.

**BIRD, JONES & KENYON,
No. 1 Blandina St., Utica, N.Y.**

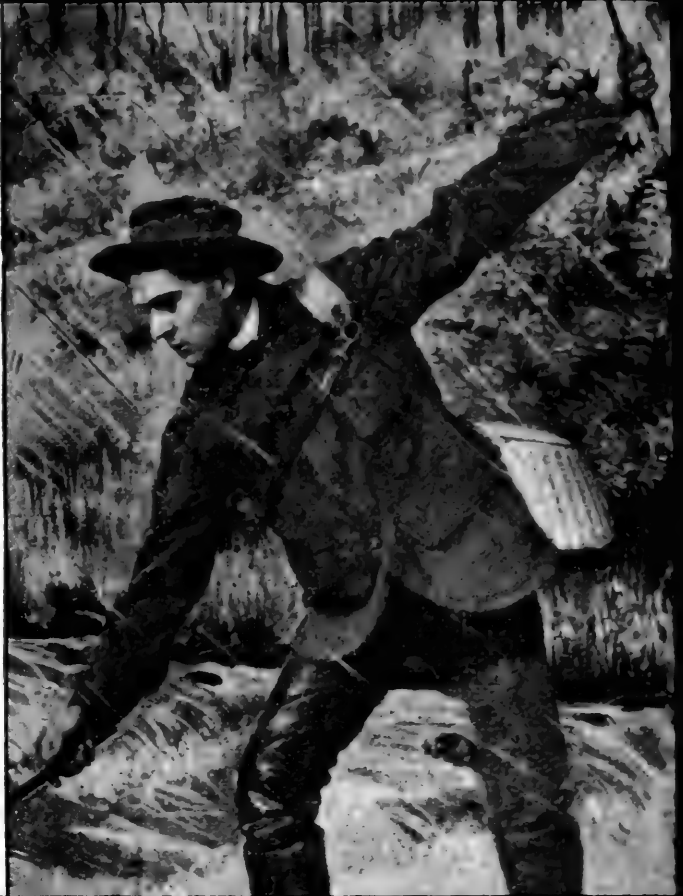

Private Secretary: There's a Duke outside waiting to see you, sir.

American Magnate: I can't see him just now; there's a directors' meeting.

"If you keep him waiting, he may not like it."

"Well, give him half a million to keep him quiet."—Exchange.

Willie: Mamma, as I was walkin' down the road to-day, I saw 2 boys ridin' ou ponies and they were havin' a fine time.

Mother: Willie, are there no g's in your vocabulary?

"Yes, ma'am, 2: Hully Gee and Gee Whiz."—Life.

Practical Common Sense in 6 Sizes. **CAMP STOVE**

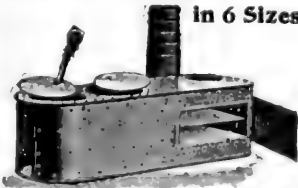

oven, holds its shape, telescopic pipe carried inside the stove. Burns large wood and keeps fire longer than any other. Used by over 9,000 campers and only one stove returned.

For catalogue giving full particulars, mention RECREATION and address

D. W. CREE, Manufacturer, Griggsville, Ill.

Swedish
COLLAN OIL
Waterproof
LEATHER
DRESSING
AND
RUST PREVENTER

"Collan-Oil"

preserves leather and renders shoes and harness positively

WATERPROOF

Used by the U. S the Army and Navy and National Guard.

Send 25c. for trial can.

AGENTS WANTED

Write for terms and circulars

J. R. BUCKELEW

Dept. A. 111 Chambers St., N. Y.

BITES

The pleasure of out door life and sports is often marred by the discomfort of mosquitoes, black flies, and other insects, which make life a burden. There is nothing so effective in ridding one's self of these terrors as

JAPSTICK
DRIVES AWAY
MOSQUITOES

THE CULECIDE CO., 170 1/2 Summer St., Boston, Mass.

Each stick burns one hour; box contains 12 sticks. Full size box sent postpaid on receipt of 25 cents.



A VALUABLE PRESENT

**For Your Wife, Your Mother, Your
Sister or Your Best Girl**

• For **25** Yearly Subscriptions to RECREATION, I will send you a set of

1 DISH AND 12 TOMATO PLATES

made by Higgins & Seiter, 50 West 22d Street N. Y. Listed at \$19.50.



And, for **20** Yearly Subscriptions to RECREATION, I will send you a set of

12 WATERMELON PLATES

listed at \$16.50. (See illustration)

THESE are fine, thin, white china plates, beautifully hand painted, with pictures of tomatoes and tomato vines, or watermelons and watermelon vines, in natural colors, and each set of plates is enclosed in a case made in an exact imitation of a large tomato or a watermelon.

No more beautiful or appropriate present could possibly be found for a lady than one of these sets.

You can earn one of them in a few hours, and at the same time earn the everlasting gratitude of the lady to whom you may give it.

SEND FOR PACKAGE OF SAMPLE COPIES FOR USE IN CANVASSING

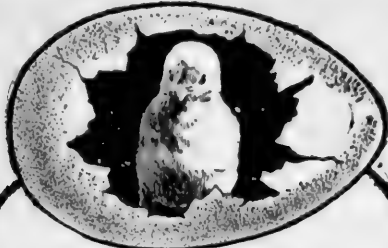

A New Star

has arisen. Not new in principle. There is nothing superior to the self regulating, self ventilating Star that has proven so popular for years. We hold on to the principle. Its hatching genius has given it a great name. But we have taken another step to popularize it and bring it within reach of poultry raisers everywhere. We have reduced the price. Poultry raisers may now have the advantages of all the genius and perfected appliances of the famous

Star Incubators

At \$6.00, \$12.00, \$20.00.

These prices for 50, 100 and 200 Egg Incubators are not duplicated by any other machine that stands in the first rank. No necessity longer to experiment or tamper with unknown appliances. All may have the machine of proverbial high per cent hatches of strong chicks. Write today for the new Star Catalog and see the special offers. We will mail copy free. It will save you half your money, while you get the surest hatching incubator in the world.

Star Incubator & Brooder Co.,
Box 25, Bound Brook, N. J.

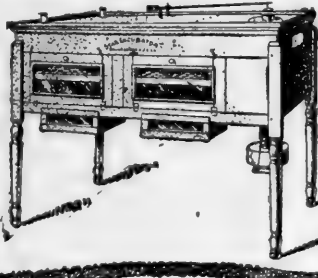

Taxidermists' Materials

Oologists' and Entomologists' Supplies

Glass Eyes for Stuffed Birds, and Animals

Send 5c. in stamps for catalogue

FRED. KAEMPFER, 88 STATE ST., Chicago, Ill.

Taxidermy work done in all its branches
Mention RECREATION



INDIAN CURIOS

WHOLESALE & RETAIL CURIO DEALERS' SUPPLY DEPOT.

Bead Work, Baskets, Elk Teeth, Mexican Goods, Beads, Fossils, Minerals, Arrow Heads, Pottery, Alaska Ivories, Shells, Azates, Photos, Great Stock. Big Cata. 5c. stamps. Mention RECREATION. If a dealer say so.

L. W. STILWELL,
DEADWOOD SO. DAKOTA



Squab Book Free



Squabs are raised in 1 month, bring big prices. Eager market. Astonishing profits. Easy for women and invalids. Use your spare time profitably. Small space and capital. Here is something worth looking into. Facts given in our FREE BOOK, "How to make money with Squabs." PLYMOUTH ROCK

SQUAB CO., 289 Atlantic Ave., Boston, Mass.

Spratt's Patent (America) Limited Aquarium Fish Food



THIS food is the result of several years' careful experimenting at our laboratory on various kinds of fresh-water fish in balanced and other aquariums. It contains the precise combination of vegetable and animal matter most suitable for the maintenance in good health of aquarium fish, in which are included tadpoles and shell-fish.

Most beginners with aquariums over-feed their fish with disastrous results, especially where a sufficient number of scavengers (tadpoles, snails) is not kept. This food of all known products is less harmful when fed in unnecessarily large quantities. A small amount should be sprinkled on the surface of the water each day, and under no circumstances should the daily meal be given unless every vestige of the last meal has disappeared. These remarks, of course, refer especially to balanced aquariums.

Price per Tin 10c, by mail 15c, 25c,
and \$1.00, postpaid.

We also manufacture a specially prepared food for dogs, puppies, rabbits, cats, poultry, game, pigeons, fish, birds, etc. Write for our free catalogue "Dog Culture," with practical chapters on the feeding, kenneling and management of dogs, with a chapter on cats. Mention RECREATION.

Spratt's Patent (Am.) Ltd.

450 Market St. 714 So. 4th St. 1324 Valencia St.
Newark, N. J. St. Louis, Mo. San Francisco, Cal.

There had been a change of curates in the parish, and Larry Doolin was asked how he liked the new man.

"Middlin," replied Larry; "but he can't come up to Father James. 'Twas he could tell you all about hell. Shure, to hear him describin' it, you'd think he was bred, born and reared there."—Sporting Times.

"I wasn't always in this condition," said the ossified man in the dime museum.

"How did it happen?" asked the obese lady.

"A girl once gave me the marble heart, and it spread," explained the hardened freak.—Chicago News.

FREE

To Sportsmen. Our new Illustrated Catalog. It tells how we can teach you to

Be Your Own Taxidermist



Learn to save your fine trophies. They are magnificent for your home, or den. Taxidermy is easily and quickly learned under our instruction. Complete course of 15 lessons and personal instruction. Standard methods, reasonable cost. The spring shooting season is open. You will get some fine birds. Mount them for yourself. Our school is endorsed by all leading sportsmen in the country. May we send you our catalog? It tells you all about the school, and it's yours for the asking. Write for one today and mention RECREATION.

The Northwestern School of Taxidermy,
Suite A., Com. Nat. Bank Omaha, Neb.

The only School of Taxidermy in the world.

GUIDE TO TAXIDERMISTRY.



Full of valuable information, with complete instructions how to prepare and mount

BIRDS, ANIMALS and FISHES.

Also a complete list of all North American Birds, with Prices of their Eggs, Skins, and mounted Specimens, an Exhaustive Line of Ornithologists', Oologists' and Taxidermists' Supplies; valuable information for the amateur. Recipes, etc., etc.

Cloth Bound, 35c., postpaid.

CHAS. K. REED,

102 UNION ST., WORCESTER, MASS.

For Sale.—Winchester 12 bore, 30 inch full choke, with extra 28 inch cylinder barrel, drop $3\frac{1}{4}$ inches, straight stock, made at factory; gun used 4 months. With box leather case, if sold at once, \$30; cost \$57. Frank Erxleben, 605 North 18th street, Omaha, Neb.

For Sale: Beaver Fur Lined Coat with cuffs and collar to match. Cost \$400; in fine condition; will exchange or sell at a bargain.

R. G. S., 280 Putnam Ave., Detroit, Mich.

For Exchange:—A Lyman sighted 25-35 Winchester Carbine, practically new, for a 45-70 Extra Light weight model '86. W. D. Church, Republic, Wash.

For Sale:—Fine mounted moose head. Also deer head. For details and photo address Box 26, Ely, Minnesota.

For Sale or Exchange:—5 x 7 Eastman Kodak in good condition. George Ahrens, Grand Forks, N. Dakota.

Wanted:—A second hand 5 x 7 Film Stereoscopic Camera. Box 221, Silverton, Colo.

RECREATION sells for itself. Don't have to do much talking.

T. W. Clumpner, Kenton, Mich.

SOME GOOD GUIDES.

Following are names and addresses of guides who have been recommended to me, by men who have employed them; together with data as to the species of game and fish which these guides undertake to find for sportsmen.

If anyone who may employ one of these guides should find him incompetent or unsatisfactory, I will be grateful if he will report the fact to me:

OREGON.

Charles H. Sherman, Audrey, bear, deer, grouse and trout.

FLORIDA.

C. H. Stokes, Mohawk, deer, alligators, turkey, quail, and snipe.

IDAHO.

John Ching, Kilgore, elk, bear, deer, antelope, mountain sheep, trout and grouse.

Chas. Petty's, Kilgore, ditto.

MAINE.

H. R. Horton, Flagstaff, deer, bear, moose, caribou, fox, grouse and trout.

Eugene Hale, Medway, ditto.

MONTANA.

A. R. Hague, Fridley, elk, deer, mountain sheep, bear, grouse and trout.

Chas. Marble, Chestnut, ditto.

WASHINGTON.

Munro Wyckoff, Port Townsend, deer, bear and grouse.

WYOMING.

S. N. Leek, Jackson, elk, bear, deer, mountain sheep, antelope, grouse and trout.

CANADA.

Carl Bersing, Newcastle, N. B., moose, caribou, deer, bear and grouse.

NEWFOUNDLAND.

John C. LeMoine, Birchy Cove, Bay of Islands, caribou, salmon and trout.

A. M. Pike, bear, caribou, salmon trout.

FOR SALE

Fine Alaskan Moose, Caribou, and Elk Heads. Price for group \$350. Photos and descriptions furnished.

C. A. Bartlett, Leadville, Colo.

My doctor orders that I take RECREATION regularly.

Chas. F. Hickok, Grand Marais, Mich.

Date, _____ 190

G. O. SHIELDS,

Editor and Manager of RECREATION, 23 West 24th St. New York.

Herewith find \$1.00 for which please send me RECREATION one year

beginning with _____ number,

Name, _____

Remit by P. O. or Express Money Order, or New York Draft.

DETACH THIS, FILL OUT, AND SEND IN

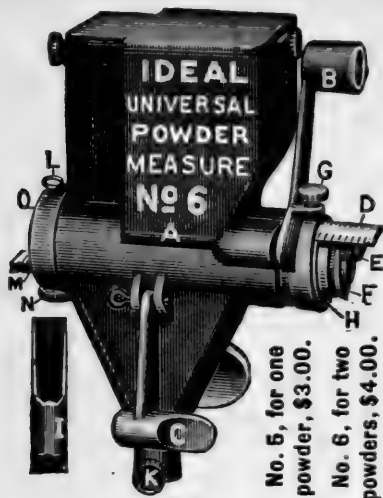

No. 5, for one powder, \$3.00.
No. 6, for two powders, \$4.00.

POWDER! POWDER!

All kinds of powder for **Rifles, Pistols** and **Shot Guns, measured accurately** from 1 to 145 grains. 4 different measures in 1. The latest and best tool. Ask your dealer for it.

Every shooter should have 1. Send 3 stamps for **Ideal Hand Book**, 146 pages of information to shooters.

IDEAL MFG. CO., 120 St., New Haven, Conn., U. S. A.

The **PHIL B. BEKEART CO.,** of San Francisco, Cal., Agents for Pacific Coast

When you write kindly mention RECREATION

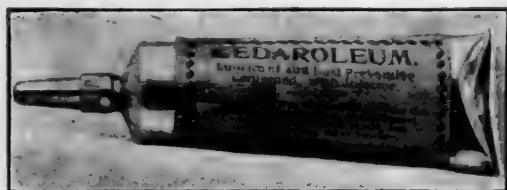

Trade CEDAROLEUM Mark

THE IDEAL CLEANER, LUBRICANT and RUST PREVENTIVE
It is colorless, impervious to atmosphere and salt-water. Will not grow rancid nor evaporate. It has all the qualities of an *up-to-date* firearm lubricant. Once used, always used. One ounce tubes retail at 15c. and two ounce tubes at 25c.; both

sizes have *injecting points*. Will be sent you by mail, if your dealer does not carry it.

Mention RECREATION.

CEDAROLEUM COMPANY, Perkinsville, Vt.

BRADLEY'S ANTI-RUST ROPES!

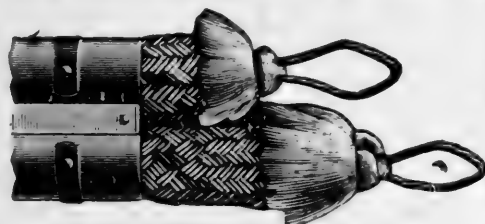

For **SHOT GUNS, RIFLES** and **REVOLVERS**. They cannot rust or pit if these ropes are used. No more worrying to keep your fire arms in perfect condition. Sent postpaid, \$1 per set for Shot Guns; 50c. for Rifles; 25c. for Revolvers. Give gauge and length of barrel. Send for circular giving full particulars.

BRADLEY'S SHOT GUN SIGHT

Makes wing shooting easy and certain. Scores greatly increased at trap and in field. Instantly attachable and detachable. Price, post-paid, 50 cents. Send for circular.

Address **C. L. BRADLEY, CLARKSVILLE, TENNESSEE.**
Mention RECREATION.

FOR SALE

SEVERAL MALE **ELK**

Also a pair or two—male and female. Fine specimens

J. W. GILBERT, Friend, Neb.

RECREATION is a literary gem.
G. Dent, Savannah, Ga.

TAN YOUR OWN Trophies

Receipt for tanning Hides, pelts, etc., sent on receipt of money order for seventy-five cents.

A. E. B., 3920 Powelton Ave., Philadelphia, Pa.

Indian Relics

—Prehistoric Specimens. Large stock list and photos ten cents.

N. E. CARTER, ELKHORN, WIS.

FINE MOUNTED GAME HEADS, BIRDS, ETC., for sale at unheard-of prices. Send 10 cents for photos.
JOHN CLAYTON, Taxidermist, Lincoln, Maine

No Rifle complete unless mounted with one of our

IMPROVED TELESCOPIC OUTFITS

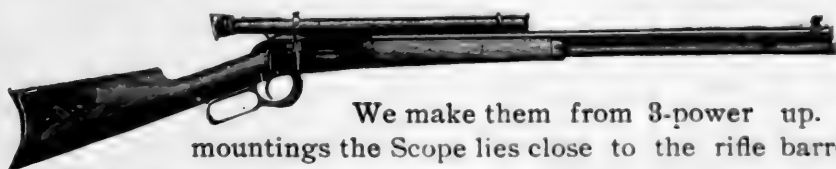

We make them from 3-power up. With our side mountings the Scope lies close to the rifle barrel and the open sights are left entirely clear and unobscured.

SEND FOR OUR CATALOGUE

Mention RECREATION.

THE MALCOLM RIFLE TELESCOPE MFG. CO.

F. T. CORNISH, Mgr.

NEWHOUSE STEEL TRAPS

Made since 1848 by ONEIDA COMMUNITY

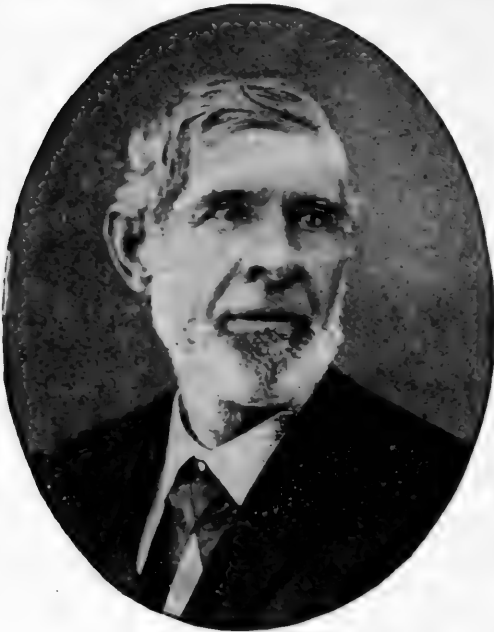

S. NEWHOUSE
(The Old Trapper and Trapmaker)

Fifty years ago this famous old Trapmaker of the Oneida Community would not let a trap leave his hand till he KNEW that it would hold any animal that got into its jaws. Even greater pains are taken now than then in selecting the finest steel and rigidly testing every part.

This is why all experienced Trappers insist on having the

“NEWHOUSE”

“I have seen an Indian trade his pony for one dozen Newhouse Traps.”—*Popular Magazine Writer.*

Eleven Sizes for Catching Every Fur Bearing Animal

Every Trap Guaranteed

Illustrated Catalogue Mailed

Send twenty-five cents for “The Trapper’s Guide,” by S. Newhouse, telling all about fur bearing animals and how to trap them, together with interesting narratives and practical directions for life in the woods.

Mention RECREATION.

ONEIDA COMMUNITY

ONEIDA NEW YORK



THE 1904 Model

LEATHER-COVERED Pneumatic Recoil Pad is now perfect. No pump, no valve, no recoil, no flinch, no headache, no bruised shoulders, no money if not satisfactory and returned at once.

PRICE, \$1.50.

J. R. WINTERS
Clinton, Mo.

KOENIG'S SHELL EXTRACTOR.



Every shooter should have one—carry it in a vest pocket. Fits any gauge shell. Koenig's Gun Catalogue, Free. E.G. KOENIG, NEW JERSEY'S LARGEST GUN HOUSE SOUTH BROAD ST., NEWARK, N. J.

AN ADVENTUROUS WOMAN.

ELIZABETH A. VORE.

One of the most remarkable women of the West is Alice Rollins Crane. Probably no other woman has risked so much, endured such privation, and triumphed so royally over obstacles that the majority of people would consider insurmountable. Alice Rollins Crane is the wife of Colonel L. P. Crane, of Los Angeles, California, a gentleman who earned his title by faithful service in the war of the rebellion. Mrs. Crane is better known to the public as Alice Rollins, the newspaper and story writer. Some years ago she had a studio in New York, where she made many friends in art, musical, and literary circles. As a vocalist she studied under Emma Abbott's tenor, Professor Apmatock.

For the last 5 years Mrs. Crane has been making a study of the Indian tribes of the Northwest, and has lived with the Moquis, Taquis, Cocopahs, and Apaches, studying their traditions and customs, and gathering material for forthcoming books. She was accompanied by her courageous young son, and has probably had more hair-breadth escapes than any other woman in America. Her recent perilous trip to the Cochise stronghold in Arizona, where she had her adventure with Kid's band of renegade Apaches, has attracted much interested attention.

Mrs. Crane's home is a quaint house after the Mexican style, situated in a pretty court of tropical bloom and overrun with vines. She calls it her “wicky-up,” and it is overflowing with Indian and Mexican curios, valuable old books, and paintings.

Mrs. Crane herself is a genial, pleasant faced woman, thoroughly generous, and deeply interested in her work. Although in no sense a “new woman,” she wore a bloomer suit during her remarkable expedition among the Apaches.

Keep at the game hogs; they don't get more than they deserve.

Charles Nelson, Los Angeles, Cal.

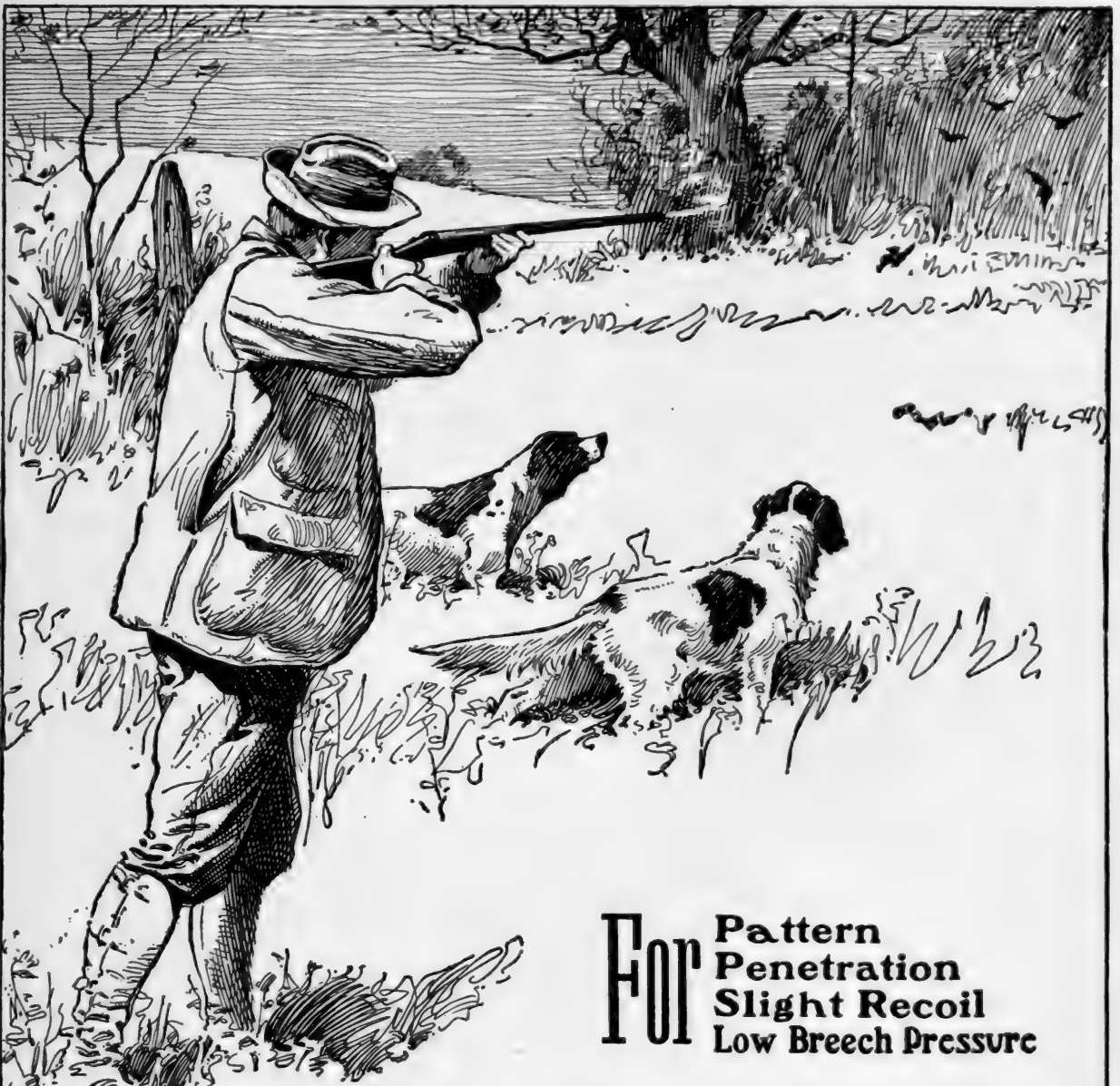

FOR Pattern
Penetration
Slight Recoil
Low Breech Pressure

USE

ROBIN HOOD

**SMOKELESS POWDER and
FACTORY LOADED AMMUNITION**

Manufactured by

*The Robin Hood Powder Co.
Swanton, Vt.*

Write for Powder Facts.

Mention RECREATION.

SLEEP

IS TIRED NATURE'S
SWEET RESTORER

After a hard day's tramp, you must have

A Good Night's Rest

in order to fit you for the next day's work. Better to sleep on a good bed without your dinner, than sip at a banquet and then sleep on the cold, hard, wet ground. You can get

A Recreation Camp Mattress

of rubber, with valve for inflating, made by the Pneumatic Mattress Co., and listed at \$ 8.

For 10 Yearly Subscriptions to

RECREATION

Send for Sample Copies

Address RECREATION, 23 West 24th Street, New York.

Syracuse Hammer Guns

Carry the same guarantee as our Hammerless Guns.

Built for Nitro Powder.

Bored the Syracuse way. Made of the best material.

Are, without doubt, the strongest built and hardest shooting Hammer guns made.

"Each gun targeted with Nitro Powder."

**Roller Bearing
Tumbler**

**Double Wedge-Fast Bolt
Through Extension Rib**



List Price \$24.

12 gauge, 30 in. High quality steel barrels. Left barrel full, Right barrel modified choke. Weight 7¼ to 7½ lbs.

DESCRIPTION :

Top lever action. High quality hammered steel barrels. Particularly adapted to Nitro Powders.

Interchangeable locks. Roller bearing tumbler; this roller bears on mainspring, and gives an extremely easy and smooth cocking motion.

Low circular hammers.

Imported walnut stock, handsomely checkered grip and fore-end. Full pistol grip with ornamental caps.

Double scored butt plate.

One-piece lug with extra wide hinge bearing.

Double wedge-fast bolt through extension rib.

N. B.—But a limited number to be marketed this year. Write for further particulars. Mention RECREATION.

SYRACUSE ARMS CO.

SYRACUSE, N. Y.

TO AMATEUR PHOTOGRAPHERS

Here is a Chance
to Get a
FINE CAMERA EASILY

A 4x5 Weno Hawk-eye film camera listing at \$8, for 5 yearly subscriptions to RECREATION. A No. 3 folding Weno Hawk-eye film camera, listed at \$15, for 10 yearly subscriptions to RECREATION.

These are both neat, compact, well-made and handsomely finished cameras, capable of doing high-class work.

*Sample copies for use in canvassing
furnished on request.*

Address **RECREATION**

23 West 24th St.

NEW YORK.

ITHACA

No. 1 SPECIAL \$21.

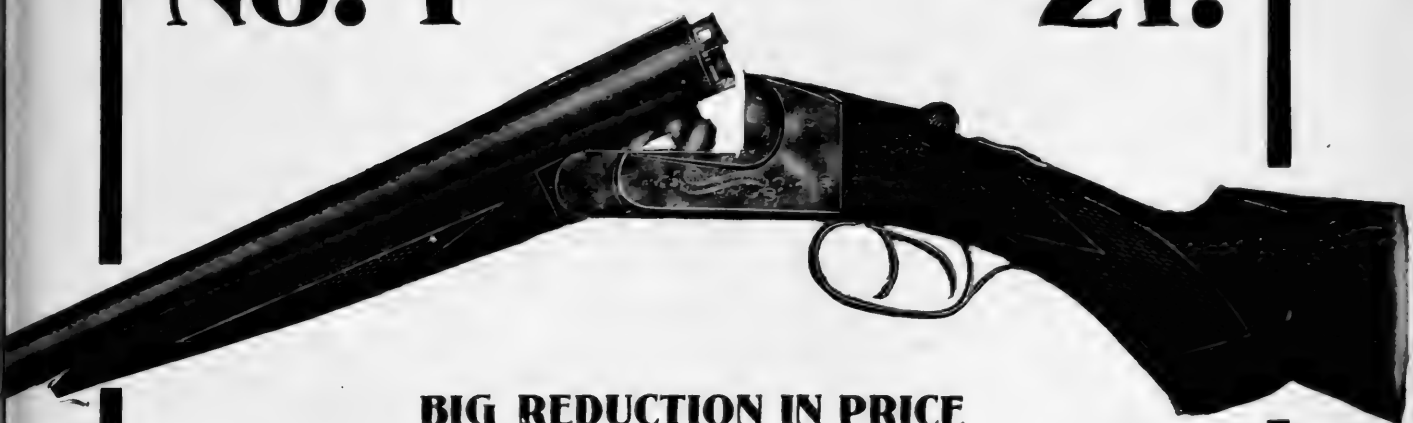

BIG REDUCTION IN PRICE

Retailed Last Year \$25.

WRITE FOR

Art Catalog

AND

SPECIAL PRICES ON 16 GRADES GUNS \$17.75 TO \$300.00

MENTION RECREATION

ITHACA GUN COMPANY

Ithaca, New York

Do
You
Want
a
Lens?

If so, why not get a good one?

And why not get it free of charge?

This is easy.

Any old box will answer the purpose if it does not leak light; but you must have a fine lens to make a fine picture.

YOU CAN GET

**A Royal Anastigmat
Lens, 4x5, Series No. 1,**

**Made by the
Rochester Lens Co., Rochester, New York**

**And listed at \$45, for 15 yearly sub-
scriptions to RECREATION**

You can get any other lens made by this Com-
pany on a basis of one subscription to \$3 of
the list price of the lens.

Sample copies of RECREATION for use in solicit-
ing furnished on application.



SAVAGE RIFLES

A GLANCE at the 22-caliber Savage Repeating Rifle will convince you that it is different from any other arm you ever saw. Besides being the best gun for small game and target work, it is the simplest and safest to handle. Its particularly strong points are accuracy and reliability, and the finish and beauty of outline will always be a source of pleasure. It will never stick or jam when you are in a hurry for a second shot, but will always work smoothly and easily. Savage Rifles are made in a variety of sizes for all different kinds of shooting and are sold to you under an honest guarantee. Write to-day for catalogue G

Savage Arms Company

UTICA, N. Y., U. S. A.

BAKER & HAMILTON, San Francisco and Sacramento, Cal., *Pacific Coast Agents.*

A London playgoer, who had drunk deeply at his dinner, appeared at the box office of one of the principal theatres, and put down a sovereign, asking for the best seat in the house. His condition was so evident that the man in the box office declined to sell him a ticket. "What's matter?" demanded the applicant, "what's matter with me?"

"Well, if you really want to know," responded the ticket seller, "you're drunk."

The frankness of this reply had a sobering influence on the playgoer. He gathered up the sovereign with dignity.

"Of course I'm drunk," he said, cheerfully, as he turned to go; "I wouldn't come to see this play if I were sober, would I?"
—Argonaut.

Your Job Printing Free:—To any person sending a new subscription to RECREATION, through me I will give free 100 visiting cards or 100 envelopes; or for 2 new subscriptions I will give free of charge 250 cards or 250 envelopes or any other kind of printed matter of equal value. Write for samples.

Henry J. Kling, Fultonville, N. Y.

The Bristol rod you gave me for 5 subscriptions arrived safely. I am more than pleased with it.

Walter H. Bowman, Chicago, Ill.

RECREATION is O. K. Goes like hot cakes with the sportsmen.

Geo. D. Breed, Chilton, Wis.

Making Shot Guns

OVER 40 YEARS

You will always find **The Parker** among the winners.

Fred Gilbert with his PARKER GUN has won the championship of 1902 and 1903, and look at his 1904 record. From January 26, 1904, to February 6, 1904, shooting in (9) nine events at 1000 targets broke 96.2%.

Our experience is valuable to you. Let us aid you in selecting a gun. Send for catalogue and mention RECREATION.

PARKER BROS., Meriden, Ct.

New York Salesrooms: 32 Warren St.

Sauer-Mauser Rifles



8 m/m or .315 caliber. Range 4,500 yards. Killing Range 3,000 yards.
Point Blank Range 300 yards. Shooting 39 grains H. P. Walsrode Powder
.236 grain Bullet.

These Rifles and other guns made by Messrs. Sauer & Son and Charles Daly—described in our specialty catalogue.

Mention RECREATION when writing.

SCHOVERLING, DALY & GALES

302-304 Broadway, New York

AN IMPORTANT OFFER

For 2 Yearly Subscriptions to RECREATION

I will send you

A RIFLE WICK PLUG

Made by HEMM & WOODWARD, Sidney, Ohio, 30 caliber up to 50 caliber.

OR

A SHOT GUN WICK PLUG

20 gauge up to 10 gauge

For 3 Yearly Subscriptions to RECREATION

A Pair of Shot Gun Wick Plugs

20 to 10 gauge.

Sample copies for use in canvassing furnished on application.

Address RECREATION, 23W. 24th St., N. Y. City

Look out for Flohr.

Readers of RECREATION are cautioned against doing business with Henry Flohr, who claims to be a representative of RECREATION. He is a swindler and should be arrested and locked up wherever found. He has taken a number of subscriptions to RECREATION and has failed to send in any of the money collected for same.

I would rather do without all other magazines than give up RECREATION.

Dr. G. C. Fordham, Watkins, N. Y.



This is the New
9 F. Grade

NEW LEFEVER

It is a plain gun, and sells at a popular price, but has all our latest improvements.

Send for
1904
Catalogue
and
Discounts

Mention
RECREATION

D. M. Lefever, Sons & Co

Not connected with
Lefever Arms Company,

Syracuse, N. Y.

H. & R. SINGLE SHOT GUN

Automatic and Non-Ejecting

The cheapest absolutely safe gun, with improvements found heretofore only in the highest priced.

PERFECT IN MODEL
AND CONSTRUCTION

SIMPLEST "TAKE
DOWN" GUN MADE

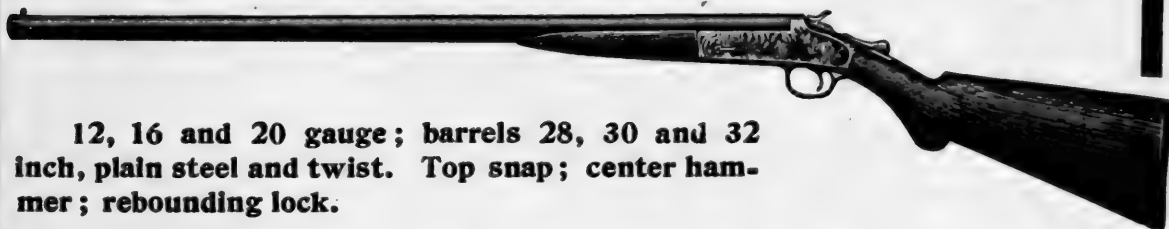

12, 16 and 20 gauge; barrels 28, 30 and 32 inch, plain steel and twist. Top snap; center hammer; rebounding lock.

Your dealer can supply, or we will sell to you direct. Write for Catalog.

HARRINGTON & RICHARDSON ARMS CO.

Dept. R, WORCESTER, MASS.

Makers of H. & R. Revolvers

MEXICAN OPAL AND SOMBRERO
FREE WITH EACH SUBSCRIPTION
TO RECREATION.

To anyone sending a new subscription for RECREATION through me, I will send free a beautiful, genuine Mexican Opal as large as a pea, together with a miniature Mexican Sombrero, made of silver and horsehair beautifully dyed. Arthur Thomson, Box 332, San Antonio, Texas.

IN ANSWERING ADS PLEASE
MENTION RECREATION.

WOULD YOU ACQUIRE

Manly Bearing
Erect Carriage
Grace and Elegance of Movement
Perfect Muscular Development

If so take a course of training in

THE NEW METHOD OF FENCING

as taught by

LIEUT. J. MARCZI DE ZOLDY

Late of the 25th Regiment, Austro-Hungarian Army.

STUDIO:

489 Fifth Avenue, New York City

Write for terms and full information

High Grade but not High Priced

BAKER GUNS
Hammer and Hammerless

Built for Hard
Service and to
last a lifetime



Send for FREE QUARTERLY and 1904 Booklet Fully
Describing all Grades with Prices. Mention RECREATION.

Baker Gun & Forging Co., No. 43 Liberty St. Batavia, N. Y.

Another Great Offer to Amateur PHOTOGRAPHERS

A 4x5 SERIES 1 KORONA

Listed at \$12.50, for 8 yearly subscriptions to RECREATION.

A 5x7 SERIES 1 KORONA

Listed at \$18, for 12 yearly subscriptions.

A 4x5 SERIES 2 KORONA

Listed at \$18.50 for 14 yearly subscriptions.

A 4x5 SERIES 3 KORONA

Listed at \$21 for 18 yearly subscriptions.

A 4x5 SERIES 4 KORONA

Listed at \$25, for 20 yearly subscriptions.

A 4x5 SERIES 5 KORONA

Listed at \$36, for 30 yearly subscriptions.

A 4x5 CYCLE POCO, No. 3

Listed at \$15, for 12 yearly subscriptions.

A 4x5 CYCLE POCO, No. 6

Listed at \$12.52, for 8 yearly subscriptions.

A 4x5 POCKET POCO B

Listed at \$10.50, for 6 yearly subscriptions.

A 4x5 PONY PREMO, No. 4

Listed at \$24, for 20 yearly subscriptions.

Sample Copies for use in Canvassing
Furnished Free

ADDRESS

RECREATION

23 W. 24th St., New York City

THE OLD NOTED Forehand, also Harrington & Richardson

BREECHLOADING

SING GUNS



For \$3.50

We offer for a time at retail, owing to a break among the Manufacturers, 3,00 of these Standard Make Shot Guns at the following unprecedented prices:

Steel Barrel, 12 or 16 Bore, plain Ejector, \$3.50 Twist Barrel, plain Eje. or \$4.25
Steel Barrel, 12 or 16 Bore, Automatic " 4.00 Twist Barrel, Autor ic 4.75

These Guns are not a cheap, low cost article got up for sale, but *first class*, of genuine make, such as have always sold at \$6.50 to \$8.00, and the reputation of the makers is a sufficient guarantee. They are in fine case hardened Mountings, best machine made and Pistol Grip Stocks. **No such bargain for a safe, reliable Gun for man or boy has ever been offered.** Send cash with order and if gun is not satisfactory on receipt, send it back and money will be refunded less cost of expressage. Also

200 Standard Make BREECH LOADING HAMMERLESS DOUBLE GUNS

Fine Twist Barrels, Cross Bolt Extension Rib, Pistol Grip and **Automatic Ejector**, made for Nitro as well as black powder, will be closed out at the low price of **\$25.00.**

SEND STAMPS FOR CIRCULARS

Mention RECREATION.

WILLIAM READ & SONS 107 Washington Street BOSTON, MASS.

Gotham contains 500,000 novelists, divided into men, women and children.

Gotham offers innumerable different ways of starving to death, a powerful appeal to our passionate love of variety.

Although everyone in Gotham has insomnia, the price of lodgings rules firm.

There are said to be places in Gotham where wholesome food can be got, but so cheaply that self respecting people never go there.

Gotham is constantly wronged by tourists, who come to see J. Pierpont Morgan lunch off a glass of milk and a piece of pie; the Statue of Liberty Enlightening the World without laughing; and other wonders.

The Battery is a mere name. The really shocking things are farther uptown.

Gotham people are spending millions, to say nothing of the time lost, in being blown up every 10 minutes, for a rapid transit tunnel which will bring them within easy striking distance of nature and nature's God.

For Sale:—Caligraph Typewriter in perfect condition. Cost \$75, will take \$25 or 38-55 Savage Rifle for same.
R. G. S., 280 Putnam Ave., Detroit, Mich.

RECREATION is the best of its class published in this country.

B. C. Morse, Scott, N. H.

The Problem of Success

at the trap is largely a problem of equipment. It is generally conceded and once you have tried a

DAVENPORT

HAMMERLESS No. 2 GUN

with Full Length Matted Top Rib or our Heavy Hammer Trap Gun, you will agree that better results are obtained with a single than with a double gun. **The Single is positively the Trap Gun of the Future**, so get in line and procure the best for the purpose. Catalogue Free.

Mention RECREATION.

The W. H. DAVENPORT FIRE ARMS CO., Norwich, Conn.



A FEW OF THE PRINCIPAL BUILDINGS OF THE
ANHEUSER-BUSCH PLANT
COVERS 125 ACRES EQUALS 60 CITY BLOCKS EMPLOYS 5000 PEOPLE

VISITORS TO THE
LOUISIANA PURCHASE EXPOSITION
ARE CORDIALLY INVITED
TO INSPECT THE
ANHEUSER-BUSCH BREWERY
WHERE COMPETENT GUIDES
SPEAKING ALL MODERN LANGUAGES
WILL BE AT THEIR SERVICE

ANHEUSER-BUSCH BREWING ASS'N
ST. LOUIS, U. S. A.

WHEAT BISCUIT

is made into two forms—BISCUIT and TRISCUIT.
The BISCUIT—served with milk or cream—is the
only standard Cereal Food for Morning, Noon and
Night. It is greater in nutritive value than any other cereal
because prepared in over 250 different varieties
combination with fruits, vegetables, preservatives and other
ingredients of food for any table course.

TRISCUIT is the New Cracker and sustains you
on land and waters. It is served with soup,
meats and beverages. Make Triscuit Your

We will send FREE our Illustrated Cook Book
"The Best of the Best" Write today.

THE NATURAL FOOD COMPANY
Makers of Shredded Wheat
SARATOGA FALLS, N. Y.

MOST PERFECT BLOCK SIGNALS ON THE NEW YORK CENTRAL.



16 horse power complete with canopy top, side basket, horn and lamps, only \$1,350.00 at the factory.

Rambler

Touring Cars

represent absolutely the highest values—our reputation is back of them. 11 light models, \$650.00 to \$1,350.00 at the factory.

Thos. B. Jeffery & Co., Kenosha, Wis., U.S.A.
Chicago, 304 Wabash Ave. Boston, 145 Columbus Ave.

Model "L"
\$1350

FEED

Your
Thinker

Brain (and other nerve matter) wastes away exactly as other portions of the human body give out—a little every hour. Unless this waste is repaired the brain gets weak and brain-fag and nervous prostration set in.

This waste is restored naturally by Albumen and Phosphate of Potash found in

Grape-Nuts

All worn-out, broken-down brains can surely be rebuilt by the use of GRAPE-NUTS, the most scientific food in the world.

If you are a thinker your brain wastes away in proportion as you use it. It can be kept KEEN on GRAPE-NUTS.

Look for the little book "The Road to Wellville" in each pkg.

There's a Reason

TRY

Stuyvesant's
DELICIOUS

MILK CHOCOLATE

(FOR EATING ONLY)

QUALITY
&
FLAVOR
UNRIVALLED!!



THE
BEST

Put up in CANES, STICKS, CHOQUETS & TIN MINIATURE MILK CANS & FRUIT

FOR SALE AT OUR STORES, SALES AGENTS & BY FIRST CLASS DRUGGISTS & GROCERS EVERYWHERE

VOSE

PIANOS

have been established over 50 YEARS. System of payments *easy* *flexible* *practical* *stanches* can own a VOSE piano. Write for catalogue D and explanations.

VOSE & SONS PIANO CO., 160 Boylston St., Boston

THE HISTORY OF THE ANTI-SLAVER...
BY THE AUTHOR AND LIEUT. J. M. DE ZOLDO, OF THE AUSTRO-HUNGARIAN ARMY

VOLUME 2
NUMBER 1



London: Printed and Sold by...

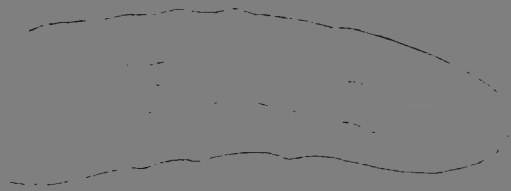

THE UNIVERSITY OF CHICAGO

DEPARTMENT OF THE HISTORY OF ARTS

1968-1969 Catalogue of the Department of the History of Arts
University of Chicago, Chicago, Illinois

Department of the History of Arts
University of Chicago, Chicago, Illinois

Because of the wide range of your cataloging supplies and
because of the wide range of your special services

UNIVERSITY OF CHICAGO PRESS
54 EAST LAUREL STREET
CHICAGO, ILL. 60607
TELEPHONE: 312-707-7000

Our office has more and many others of our good
things to carry in convenient packages.

UNIVERSITY OF CHICAGO PRESS
54 EAST LAUREL STREET
CHICAGO, ILL. 60607

RECREATION

Copyright, December, 1903, by G. O. Shields

A Monthly Magazine Devoted to Everything the Name Implies

\$1.00 A YEAR.

10 CENTS A COPY.

G. O. SHIELDS (COQUINA),

Editor and Manager.

23 WEST 24TH STREET,

NEW YORK

CONTENTS OF THIS NUMBER

	PAGE.
An Evening Flight of Bats.....	FRONTISPIECE 396
Animal Life in a Cuban Cave.....	AUGUST BUSCK 397
The New Method of Fencing. Illustrated.....	F. SCHAVOIR, M. D. 401
Hard Eggs. Poem.....	GEO. A. WILLIAMS, M. D. 411
On Snubbing.....	E. J. MYERS 412
Among the Islands of Georgian Bay. Illustrated.....	MAY BRAGDON 413
I Go A-fishing. Poem.....	R. S. STRINGFELLOW 419
Pranks of Porcupines.....	G. O. SHIELDS 420
An Apostrophe to My Canoe. Poem.....	R. R. KIRK 422
On Top of California.....	D. M. LADD 423
Summer. Poem.....	WILLIAM R. BERRY 424
A Day on Lake Owen.....	C. C. HASKINS 425
The Monarch of the Pool.....	F. H. ROCKWELL 450
From the Game Fields..... 427	Forestry..... 443
Fish and Fishing..... 432	Pure and Impure Foods..... 446
Guns and Ammunition..... 436	Editor's Corner..... 448
Natural History..... 439	Amateur Photography..... 458
The League of American Sportsmen..... 442	

Entered as Second-Class Matter at New York Post Office, Oct. 17, 1894.

WASHBURNE'S Pat. Imp. FASTENERS



The Fastener with a
BULL-DOG GRIP

Men find comfort and utility
in their use. Applied to

Key Chain
and Ring, 25c.
Cuff
Holders, . 20c.
Scarf
Holder, . 10c.
Drawers
Supporters 20c.

Sent
Postpaid.

Little,
but
Never
Let Go.

Cata-
logue
Free.

Sold Everywhere.
American Ring
Company,
Dept 44
Waterbury, Conn.



Skin Diseases

If you suffer from Eczema,
Salt Rheum, Ringworm, Itch,
Acne, or other skin troubles,

Hydrozone

will cure you.

As these diseases are caused by para-
sites, killing them without causing injury
to the healthy tissue cures the trouble.
It has cured many cases pronounced
incurable and is absolutely safe.

Hydrozone is a scientific Germicide.
Used and endorsed by leading physicians.
It is absolutely harmless, yet a most pow-
erful healing agent.

Trial bottle at your druggist or by
mail on receipt of 25 cents. None genu-
ine without my signature on label.

Prof. Charles Marchand

F-59 Prince St., New York.

Free—Valuable Booklet on How to Treat Diseases.

Everything the Camper Needs

SEND 10c for our new catalogue "R," 240 pages of information useful to the Camper, Hunter, Fisherman, Canoeist, and all those who live out-of-doors, also to those who use Ammunition, Fishing Tackle, Canoes, Tents, Clothing, Cooking Outfits, Sleeping Bags, Stoves, Pack-saddles, Pneumatic Beds and Cushions, etc., etc.



Free with every purchase to the amount of ten dollars, we will include a reproduction of this picture, 11x18 inches, drawn by Thomas Fogarty, for "The Forest," by Stewart Edward White. Every lover of nature should make this book a part of his outfit. Price, \$1.50. Mention RECREATION.

ABERCROMBIE & FITCH

MANUFACTURERS OF

**COMPLETE OUTFITS FOR
EXPLORERS, CAMPERS AND PROSPECTORS**

314-316 Broadway, New York



THE OLD WAY

THE BOAT as pictured below in every detail—length $15\frac{1}{2}$ feet, beam 4 feet, with $\frac{3}{4}$ h. p. Blomstrom gasoline engine,

\$100

*So simple a child can operate
with entire safety*

Catalogue D, including Marine Gasoline Engines of from $\frac{1}{4}$ to 80 horse-power at corresponding prices, free on request.

THE C. H. BLOMSTROM MOTOR CO.
1284-1294 River Street Detroit, Mich.

[From the Chicago Journal, May 7th, 1903]

At last an honest soul has put a $15\frac{1}{2}$ foot launch with gasoline engine—4 foot beam—within the reach of the masses.

THE NEW WAY

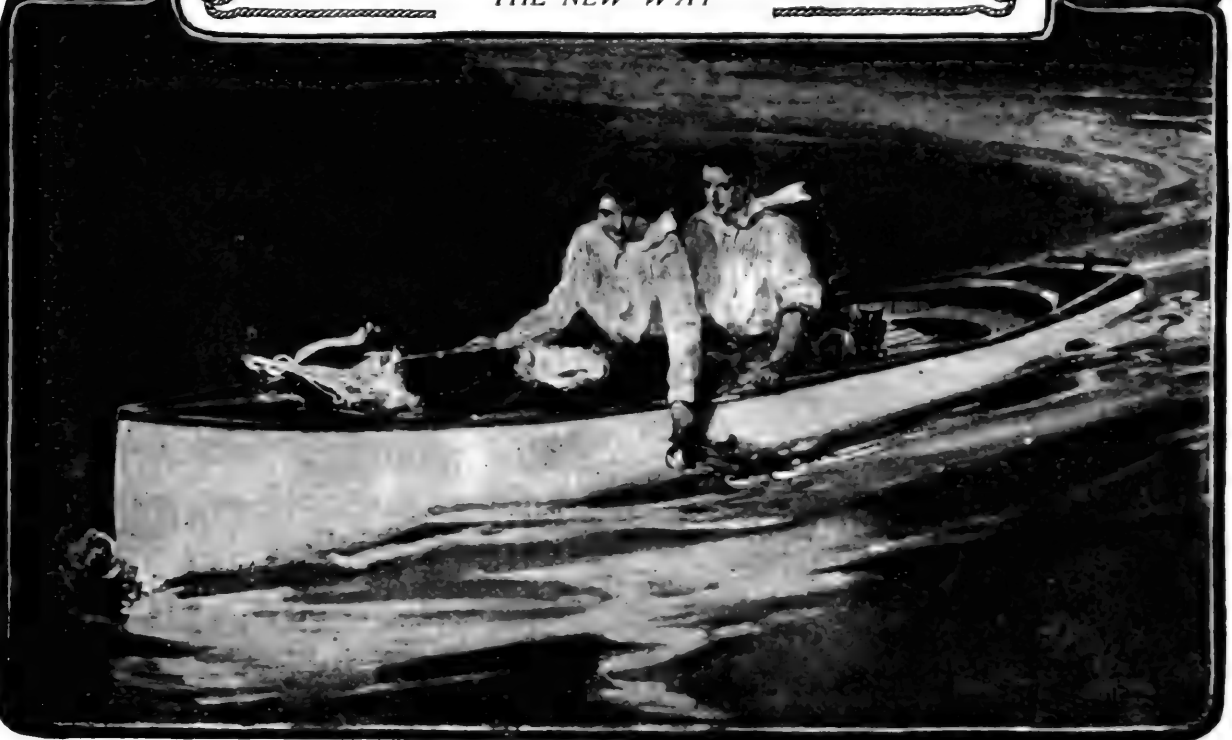

LAUNCHES

"Within the reach of all"



38 ft. cabin cruiser equipped with 10 H. P. naphtha engine. Furnished complete throughout, fitted with galley, lavatory, etc. Has sleeping accommodations for four people.

21 ft. open launch equipped with 2 H. P. naphtha engine. Over 5,000 of this type in use



35 ft. auto-boat equipped with 12 H. P. new design Speedway Gasoline motor. We build these in sizes from 30 to 70 ft. Speed from 12 to 35 miles per hour.

Our show rooms contain 100 finished Launches to select from



Send 10 cents in stamps for new Catalogue of Auto-Boats, Naphtha or Alco Vapor Launches



Gas Engine & Power Co. and Charles L. Seabury & Co.,

Consolidated

LARGEST BUILDERS OF PLEASURE CRAFT IN THE WORLD

Morris Heights, New York City

Down-Town Office, 11 Broadway

Chicago Office, 1409 Michigan Ave.

RACINE BOAT MANUFACTURING COMPANY

MUSKEGON, MICHIGAN



Our Turbine Motor Hunting Boat, as shown above, is 16 feet long, draws loaded only 10 inches of water, is fitted with our 3 H.P. motor and *underwater* exhaust. No springs, no valves, no *clicks*—as noiseless as a Row Boat. Speed 6 miles per hour. Operation and satisfaction guaranteed for \$275. Cheaper ones if you want them.



Our Canvas Cedar Paddling Canoe, as shown above, is 14 feet long, will carry four in a pinch and is built for service. A comfortable and easy paddler. Price, F. O. B., \$30—no extras.



Our Still Hunter, as shown, 11 ½ feet long, 36 inches wide, built of White Cedar, will carry 600 lbs., weight only 80 lbs. Ample room under deck for decoys. Light weight, light draught, very stiff, very still and very cheap. Price, complete with paddle \$20, F.O.B.

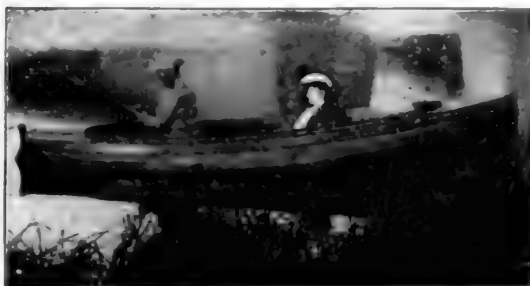

Our 15 foot Fishing Motor Boat is the "limit." Has 4 foot beam, draws 12 inches, speed 6 miles per hour, seats four to five, will carry 1,000 lbs. 1 H. P. motor, operation guaranteed. Built of Cedar, natural finish, brass trimmed, a good troller, a good guide to the fishing grounds and a sure returner. We have them in stock at our various warehouses—price \$165. Money refunded if not satisfied.

Send 10c. for our 64 page catalog describing the others, and we will tell you the address of our nearest showrooms. If you haven't the stamps handy drop a postal.

Mention RECREATION.

Address: **RACINE BOAT MFG. CO., (Riverside) MUSKEGON, MICH.**

BETTY ZANE

The Heroine of Wheeling



BETTY

AN historical romance—
thrillingly interesting
from beginning to
end. A true story of the
struggle for independence and
the siege of Fort Henry,
September 11, 1782, told by
a descendant of the Zanes who
bore such an important part
in the events of that period.

A TRUE STORY
Illustrated in India Tint

\$1.50

By
P. ZANE GREY

OPINIONS OF THE PRESS

New York Sun—"The incidents of pioneer life would excite interest even if they were less well handled."

New York Times—"Entertaining reading."

Syracuse Herald—"Has handled his subject well."

Southern Star (Atlanta)—"It has the life, the coloring, the very breath of those pioneer days."

Recreation—"Recounts vividly the perils, the hardships and the privations of the sturdy pioneers."

Public Opinion—"Written primarily for the benefit of the Revolutionary Daughters Societies, will interest others equally."

Brooklyn Daily Eagle—"One welcomes most cordially the appearance of a Fenimore Cooper frontier story which is told without melodramatic exaggeration, without tiresome prolixity (Cooper's fatal fault), and with a just and well poised admixture of history and romance."

Zanesville Daily Courier—"Every school girl knows and loves Betty Zane, the heroine of the beleaguered garrison at Wheeling, long, long ago. Dr. Grey has portrayed the real Betty Zane; and has given us the real thing in pioneer life."

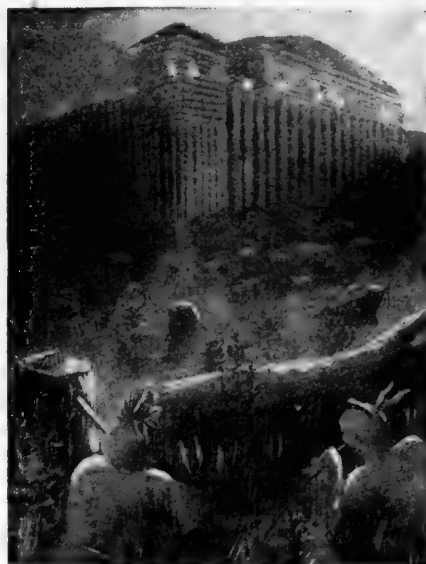

FORT HENRY

PUBLISHED BY

CHARLES FRANCIS PRESS

30-32 WEST THIRTEENTH STREET, NEW YORK CITY

SPECIAL For 30 days we will mail you prepaid one copy of **\$1.75**
Betty Zane and give you *Recreation* for 1 year for

"Free from the care which wearies and annoys,
Where every hour brings its several joys."

"AMERICA'S
SUMMER
RESORTS."

This is one of the most complete publications of its kind, and will assist those who are wondering where they will go to spend their vacation this summer.

It contains a valuable map, in addition to much interesting information regarding resorts on or reached by the

NEW YORK CENTRAL LINES

A copy will be sent free, upon receipt of a two-cent stamp, by George H. Daniels, General Passenger Agent, New York Central & Hudson River Railroad, Grand Central Station, New York.

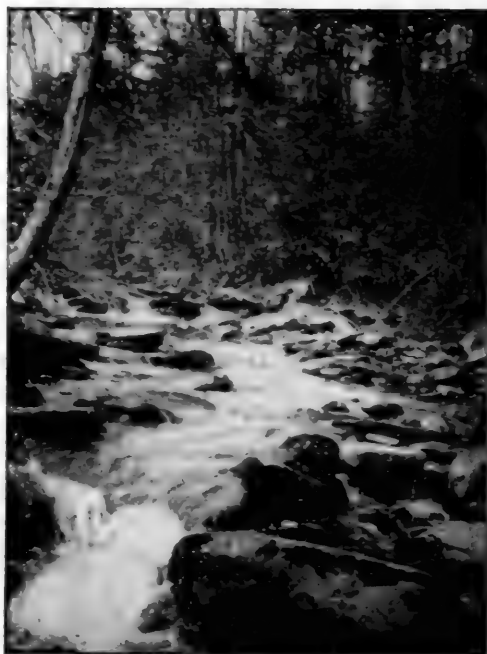

TROUT STREAM



“Fishing on the Picturesque Erie,”

A Beautifully Illustrated Booklet containing valuable articles on fresh water fishes and fishing, written by veteran anglers, and a complete and reliable directory to the lakes and streams along

the lines of the Erie, where the best sport may be found. New and enlarged edition for 1904 will be ready for distribution about April 15th, and can be obtained from any Erie ticket agent in New York City and Brooklyn, or by sending four cents in stamps to the undersigned.

The Black Bass Fishing in the Upper Delaware is unsurpassed. The Erie follows the course of this beautiful river for over sixty miles.

Trout Streams too numerous to mention, but the Erie Fishing Book will tell all about them.

“Rural Summer Homes.” An illustrated directory to the Hotels and Boarding Houses in the beautiful Summer Land along the Erie, will be ready about April 1st. Free, on application to Erie ticket agents, or by sending eight cents in stamps, for postage, to



DELAWARE RIVER VIEW

D. W. Cooke, Gen. Pass'r Agent, New York

Mention RECREATION



From Puppyhood to Doghood

A dog is subject to many ills, liable to various diseases. Sickness attacks the average dog as often and in much the same way as it attacks the average man. He contracts a cold from exposure or sudden changes in the weather, which, if not cured, is liable to develop distemper. Sometimes, from over-eating or improper diet, his digestive organs become deranged, he suffers from indigestion, constipation and biliousness. The various ills that assail dogs, each has its counterpart in human maladies.

The one great, over-towering remedy of the dog world, the medicine that cures nearly all canine ills, is

Sergeant's Condition Pills

This remarkable medicine has been the means of saving more dogs' lives than any other remedy on the market. It cures indigestion, nervousness, general debility, insomnia, meanness, mange, distemper, chills and fever, and other diseases common to dogs. It is a tonic and alterative, puts the entire system in good shape, creates appetite, gives strength, life, and vim.

Large box, \$1.00; small, \$.50

On sale at druggists and sporting goods dealers, or sent postpaid to any address upon receipt of price.

Sergeant's Sure Shot Destroys Worms

When you see a full grown dog with a dead-looking coat of hair, coagulated matter around the eyes, dull, sleepy look, lazy gait, and an appetite which no amount of feeding will satisfy—that dog is wormy.

Worms in puppies produce nausea, colic, pains, restlessness, feverishness and fits, stunt the growth, and in the majority of cases, if not destroyed, soon kill the puppy. Sergeant's Sure Shot is a sure destroyer of all canine worms. In thousands of cases it has been successful, and not once has it failed. It is quick, sure and harmless.

Price, \$.50, postpaid to any address

Send 3 cents for postage and we will send you our handsome Dog Book and a Pedigree Blank, free. Write to-day. We will send any of our dog remedies on receipt of price, if your druggist cannot supply you.

POLK MILLER DRUG CO., RICHMOND, VA.



IN THE ADIRONDACKS—The New Hermitage At Lake Bonaparte, New York,

Once the property of King Joseph Bonaparte, and named in his honor.

The hotel has all the modern improvements and accessories. Broad verandas, wide, roomy halls, large open fire-places, reading rooms, billiard rooms, telephone, daily mail.

Guests have the opportunity of enjoying delightful rowing, canoeing, bathing. The finest fishing in the Adirondacks, Croquet, Tennis.

House open from June 1st to December 1st.

A park containing 800 acres; beautiful walks and drives.

Handsomely illustrated book, giving full information, sent on request

Mention RECREATION.

DAVID SCANLIN, Proprietor, Bonaparte, New York.

“At the Gateway of the Adirondacks.”

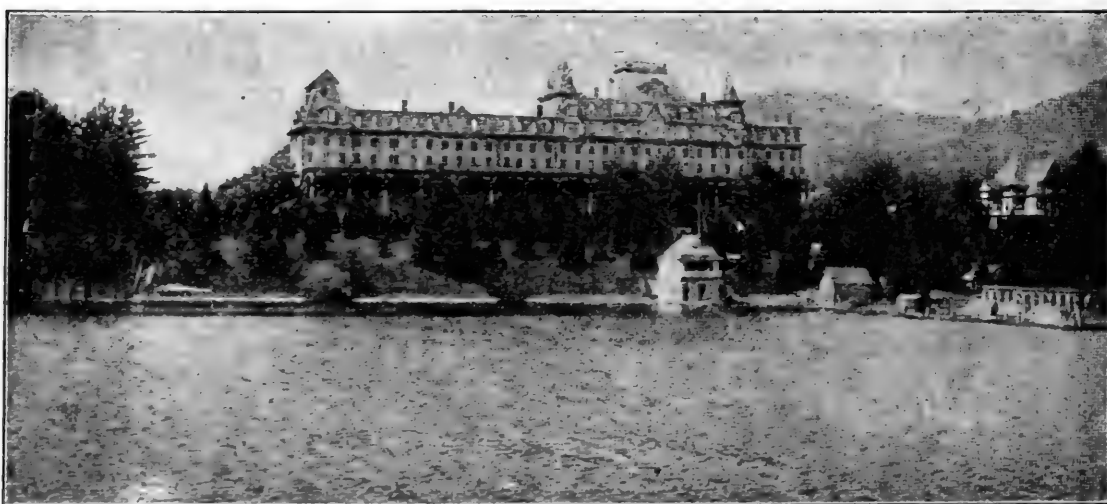

THE NEW Fort William Henry Hotel

One hour north of Saratoga Springs

Lake George, New York

Owned by the Hudson Valley Railroad Company. Hourly trolley service between Lake George and Saratoga. Situated in a delightful wooded park on the shores of the most beautiful of American lakes. Every modern improvement; hotel elaborately refitted and refurnished; perfect fire safety equipment; modern plumbing; boating; bathing; golf; fishing; charming drives.

W. W. BROWN,
MANAGER

15 years with Sagamore Hotel, Lake George

OPEN JUNE TO OCTOBER

An Ideal Sea Trip

Offered by the

RED CROSS LINE

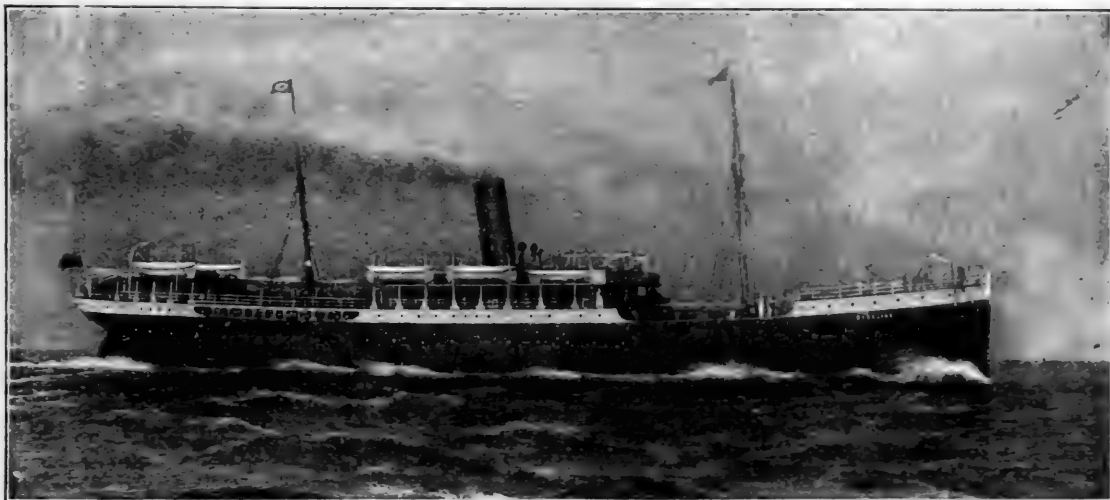

A CHARMING daylight sail through **Long Island, Vineyard and Nantucket Sounds.** Fine view of picturesque **Nova Scotia** and of the bold, rugged **Newfoundland Coast.** A two weeks' cruise at one-quarter the cost of going to Europe and a greater change of air and scene. Steamers sail weekly, making the round trip from New York to St. Johns and return in thirteen days and there can be no more delightful ocean voyage for those who want rest and sea air. The steamers remain in Halifax one day, going and returning, and two days in St. Johns, thus giving passengers an opportunity to visit these beautiful and interesting cities and surrounding country. The cost is low and the accommodation and services the very best. (Stop-over privileges allowed.) For sailing dates and full information apply to

Bowring & Company, State¹⁷ St. New York

THOUSAND ISLAND HOUSE,

ALEXANDRIA BAY,
ST. LAWRENCE RIVER,
NEW YORK.

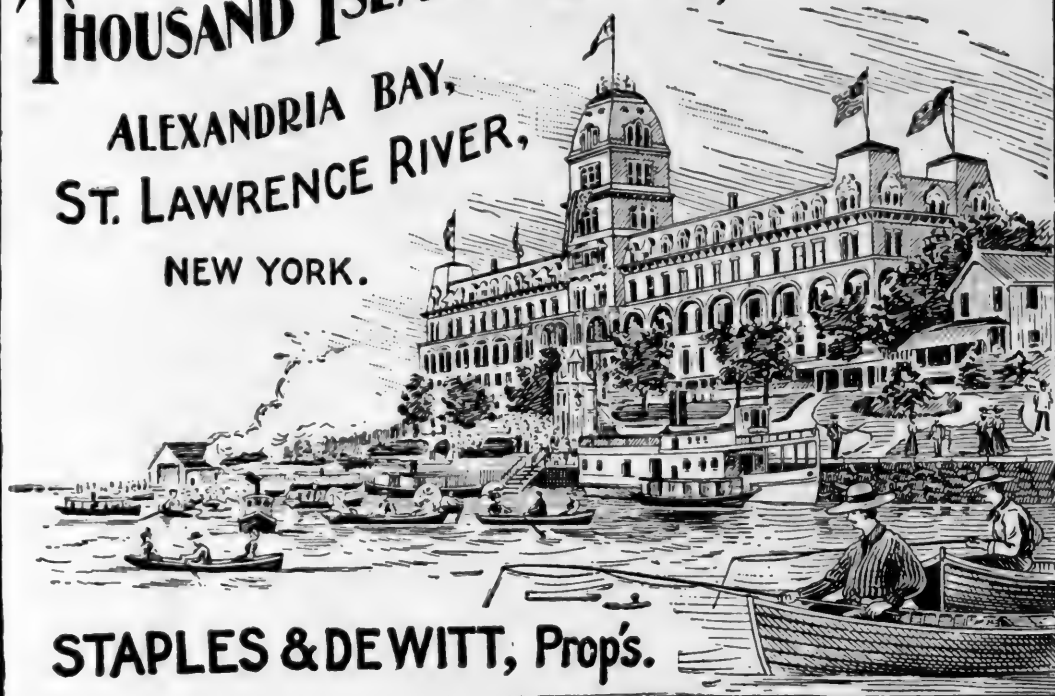

STAPLES & DEWITT, Prop's.

1000 Island House

In the midst of the "Thousand Islands," the so-called "Venice of America," and really the most charming and delightful Summer Resort on the Continent.

Send us two 2-cent stamps and we will send you a beautifully illustrated guide book. Mention RECREATION.

STAPLES & DEWITT, *Proprietors.*

Alexandria Bay, N. Y.

HOTEL CHAMPLAIN

Bluff Point near
Plattsburg, N. Y.

Finest Golf Links
in the Adirondacks



**Known Everywhere as One of the Most Magnificent
Summer Hotels in America.**

Located on a bold eminence on the shore of Lake Champlain in the center of a natural forest park of 450 acres.

Superb views of the Lake and Green Mountains of Vermont to the East, and the highest peaks and ranges of the Adirondacks to the West.

GOLF on full-length 18-hole course, kept in pink of condition. Attractive club-house with all conveniences.

HOTEL CHAMPLAIN is three miles from Plattsburg, N. Y., on main line Delaware & Hudson R. R., and is reached in through Pullmans.

BOATING, FISHING, and ideal fresh-water bathing, complete facilities. Splendid roads for automobiling.

A beautiful booklet of illustrations sent upon request.

E. L. BROWN, Manager, Until July 1st care LINCOLN SAFE DEPOSIT CO.
42d Street, NEW YORK

A Wing Piano

is a joy in any household. You can get a strictly high-grade piano by writing us direct and can save \$100 to \$200 on it. Sent on trial. We pay freight. Easy monthly payments. No money required in advance. In 36 years we have sold 33,000 pianos and refer to over 33,000 satisfied purchasers. Wing Pianos are guaranteed for 12 years. "Book of Information about Pianos" sent free on request. Mention RECREATION.

Wing & Son

350 to 356 W. 13th St.

New York





This Summer

"ROYAL MUSKOKA" HOTEL MUSKOKA LAKES. CANADA

—for your vacation

Come to "beautiful Canada"—among the Muskoka Lakes—to the loveliest spot you have ever seen.

New scenes, new sports and new associations—a new sense of life in the cool, bracing air.

All the charm of primeval pine forests, rugged rocks and sparkling waters—with the luxury and comfort of the best American hotel.

Muskoka is easy of access from all American points, via Niagara Falls, Detroit and Chicago.

HAY FEVER UNKNOWN

Handsomely illustrated descriptive matter free. Apply to

G. T. BELL,
Gen'l Pass'r & Ticket Agt.,
Grand Trunk Railway System,
Montreal, Canada.

OR

ALAN F. CAMPBELL,
Mgr. "Royal Muskoka" Hotel,
Muskoka Navigation Co.,
Gravenhurst, Ont.

"The land of lakes and islands—the Killarney of America."

MUSKOKA

COUNT CASSINI SAYS:

Russian Imperial Embassy, Washington.

The HAYNER WHISKEY which has been used at the Russian Embassy has given universal satisfaction. It is an admirable household whiskey.

Count Cassini

Russian Ambassador.

**THE ONLY WHISKEY WITH A NATIONAL REPUTATION FOR
HIGHEST QUALITY AND PERFECT PURITY.**

Government statistics show that the famous Miami Valley produces better grain and has purer water than any other section of this country. It is Nature's garden. Right in the heart of this favored spot is our distillery. We have at our very door the two essentials for producing the finest whiskey in the world--the best grain and the purest water. Add to these one of the most completely equipped distilleries ever operated and an experience of 38 years in distilling whiskey and you have a combination that is unequalled anywhere. That's why HAYNER WHISKEY is the best for medicinal and other uses. That's why we have over half a million satisfied customers. That's why YOU should try it. Don't forget that it goes direct from our own distillery to you, with all its original strength, richness and flavor, carries a UNITED STATES REGISTERED DISTILLER'S GUARANTEE of PURITY and AGE and saves the dealers' enormous profits. Your money back if you're not satisfied.

HAYNER WHISKEY

4 FULL QUARTS \$3.20
EXPRESS CHARGES PAID BY US.

OUR OFFER We will send you **FOUR FULL QUART BOTTLES** of HAYNER SEVEN-YEAR-OLD RYE for \$3.20. and we will pay the express charges. Try it and if you don't find it all right and as good as you ever used or can buy from anybody else at any price, then send it back at our expense and your \$3.20 will be returned to you by next mail. Just think that offer over. How could it be fairer? If you are not perfectly satisfied you are not out a cent. We ship in a plain sealed case, no marks to show what's inside.

Orders for Ariz., Cal., Col., Idaho, Mont., Nev., N. Mex., Ore., Utah., Wash., or Wyo. must be on the basis of 4 QUARTS for \$4.00 by EXPRESS PREPAID or 20 Quarts for \$16.00 by FREIGHT PREPAID.

ESTABLISHED
1866.

THE HAYNER DISTILLING COMPANY,

**DISTILLERY
TROY, OHIO.**

DAYTON, OHIO.

ST. LOUIS, MO.,

ST. PAUL, MINN.,

ATLANTA, GA.,







THE EVENING FLIGHT OF BATS.

RECREATION.

Volume XX.

JUNE, 1904

Number 6

G. O. SHIELDS (COQUINA), Editor and Manager

ANIMAL LIFE IN A CUBAN CAVE.

AUGUST BUSCK.

The entire Eastern end of Cuba is undermined by subterranean galleries, which often widen out into considerable chambers, constituting a wonderful world of darkness, which is only here and there connected with the world of sunshine above by air shafts. I had found 2 of these and had tried to gain an entrance to the caverns below; but both had been narrow and shallow and I had crawled on hands and knees through muddy galleries only to meet some obstacle which prevented further progress and forced me to retrace my crawling, backwards.

One evening, just after sunset, we were riding along an elevated, narrow path toward the charmingly situated sea town, Baracoa, when I saw, about a mile from us, what, to my uninitiated companion, appeared a mighty column of black smoke, which gradually spread out like a cloud and dispersed in the evening shadows. From having previously observed similar phenomena, though never before of such magnitude, I knew it was innumerable bats, which had issued from their quarters under ground for their nightly flight. To investigate such a bat cave was a particularly desired object for me, for entomological reasons. That evening we found in the neighborhood a native who was willing and able, for a consideration, to conduct us to the entrance of that cave the following day.

Early next morning a friend and I rode out to the native's primitive palm hut, where we left our horses.

Then, led by our guide, who cut our way through the dense underbrush with a dextrous swinging of his machete, we moved in under the humid shade of the tropical forest. After more than an hour's difficult travel we reached a small clearing in which appeared the mouth of the cave, a large, nearly square, hole in the ground, some 30 feet in diameter and about 25 feet deep, with perpendicular walls full of large and small crevices. At one side of this excavation was the real entrance to the cave proper, a deep, black, apparently bottomless opening, about 15 feet square.

I crawled down in the antechamber, which was comparatively easy on account of the numerous holes, making good steps to descend by; but I stopped short and regained the surface quickly as my hand touched something moving, which, without taking time to look, I realized was a large snake. Then we took a closer look and found that every hole in the wall was the home of a beautiful, but not quite reassuring, large snake. There were hundreds of them in that half dark chamber.

This was sufficient for my companion, who hitherto had been anxious to follow me and help me explore the cave. He concluded he could see all he wished from above. The guide, however, was more courageous and, as I knew that no poisonous snakes are found in Cuba, he and I soon went down in the chamber, snakes or no snakes. They proved harmless, lazy fellows in spite of their size of 4 to 10 feet. With some difficulty

we pulled a few of them out, and half a dozen accompanied me home in a box. They are now enjoying more civilized quarters in the National Zoological Park in Washington.

It was a unique situation to stand there in the center of the antechamber, while the guide felled a tall tree, with which to enable me to proceed down in the real cave. Around me these strikingly marked reptiles moved about in the recesses of the wall, disturbed by the unusual presence of man, and a dozen or more small owls glided noiselessly through the air from side to side to find safer and darker resting places. The floor of the cavity was a soft black soil, accumulation of decayed leaves; and the turning over of a few loose rocks revealed some large centipedes, a scorpion and several cockroaches and spiders.

The guide returned with a tall, slim, branchless, trunk, 30 feet long, on which I was to clamber down in the real cave; but when we sent it down the opening it disappeared entirely and without any sound. I began to despair of being able to investigate farther down. To tell the truth I had some feeling of relief in thus escaping, with honor saved, that uninviting darkness. However, the guide had more sense of responsibility, having contracted to enable me to go down in the cave itself. He was already engaged in felling another taller tree; and he did not rest until he had fastened 2 together and plunged them down the aperture. That time they reached bottom leaving some 5 feet of the trunk exposed, which meant that the hole was between 40 and 50 feet deep. Then he indicated with what I thought a malicious smile, that he had done his part and it was up to me. I could find no excuse to escape, so down I went, candle, matches and revolver in my pockets and my insect net between my teeth.

Once down I found myself in a

huge chamber into the depths of which the light from my candle only penetrated slightly. However, I could realize that I stood on the highest part of the floor, and that this declined on all sides. Far away to the right I saw the sparkle of water. The floor consisted of tons of guano, the accumulated excrements of centuries from the millions of bats inhabiting the cave and now clinging in immense clusters under the roof.

The guano was covered, more than an inch deep, with red mites; a struggling, moving mass of animal life, which soon covered my shoes and leggings. The fermentation of this enormous mass of guano created an almost unbearable heat and stench, which made a prolonged stay impossible. Besides I dared not walk many steps for fear of falling into some bottomless hole or being buried in some soft part of the manure. It is essential on such an exploration that there be 2, tied together, so that if one slips in the unknown darkness, the other can haul him up again. That part of his mission my friend above had not realized. I had to content myself with what I could observe near my tree trunk, which I had no desire to leave under the circumstances.

The wall next to which I stood was covered with pupariums of flies, the larvæ of which fed in the manure. Countless little black gnats swarmed around my candle and other flies were caught in my net.

I fired a shot from my revolver, to disturb the bats, and the result was startling. As the large flocks dislodged and flew to deeper, distant galleries, an astonishing multitude of their parasites fell from them and their roosting place and came down over me like a thick rain, extinguishing my candle and darkening the light from the entrance above me. Large and minute, winged and unwinged, they lodged in my hair and mustache and clothing. Being an entomologist

these parasites were the principal object of my visit, and under other circumstances I should have delighted in seeing so many of these interesting insects. In fact, there is a remarkable new form of bat louse, collected on another memorable cave expedition in Porto Rico, named in my honor; an honor which it may be difficult for non-scientists to appreciate! I was most anxious to obtain a collection from the Cuban cave; but at the time I felt altogether too buggy. I at once began the climb upward, rather more than half suffocated by heat, stench and lice.

Again I breathed pure air! After securing my snakes, and filling my cyanid bottles with the contents of my net and the scrapings from my clothes, we made for our horses and galloped to the river for a refreshing clean up and a swim.

We had arranged with our native to return to the cave in the evening in order to witness the sight of the outflying bats, some of which I also wanted to secure for identification, and for the smaller, more tenacious species of parasites, not so easily dislodged; so the bath over, we procured, in a country store, some chicken and rice in curry, the national dish. That, with good bread, fried bananas, good wine and excellent coffee fully satisfied our hunger. Afterward we lounged away the hottest part of the day in the dense shade of a mango tree with a real Havana, and just before the sun went down were we with our guide at the cave.

We found others waiting for those bats. From each hole in the walls of the antechamber reached out the head of a snake, with its tongue playing, ready for a meal. These snakes evidently subsisted exclusively on bats and led as ideal, lazy a life as a snake could wish, merely opening

their mouth at mealtime and closing it again over a bat; a veritable snake paradise at the entrance to inferno.

A few single bats flew up from below, made a circuit in the antechamber and disappeared down again; probably scouts, sent to see whether the advance of the army would be safe. Presently a roar, as of a storm, was heard from the cave as the millions of small animals loosened themselves and made for their exit. For a full half hour we had a sight seldom witnessed. In a dense black column rose the multitudes of bats out of that hole. A single stroke with my butterfly net would bring 30 to 50 whining, biting, fluttering fellows into my large collecting box and a sack brought along for the purpose. Both were soon filled and I contented myself with looking at the strange spectacle. Darkness had come and the guide kindled a brush fire, which illuminated the weird scene. The upward stream seemed never to cease; but as suddenly as it had begun it ended. A few stray bats, kept back probably by the unusual light, circled about and away, and the hole was empty darkness again, in which the snakes digested their late dinner in peace.

To quiet the protest of Mr. Coquina, whose propaganda against wanton killing I most heartily endorse, I report that the bats we collected were examined the same night and with the exception of a few, which had been bitten and killed by their comrades, were liberated to find their old or other quarters, none the worse for the experience, except that they did not get any supper that night and that they were relieved of some parasites now treasured in the collection of the United States National Museum.

"Drink, and the world drinks with you."
 "True; but you settle with the waiter alone."—Life.



AMATEUR PHOTO BY W. E. LURCHIN.

PATCHING THE CANOE.

Winner of 47th Prize in RECREATION'S 8th Annual Photo Competition.



AMATEUR PHOTO BY FRANK C. NASH.

GREAT BLUE HERON.

Winner of 43rd Prize in RECREATION'S 8th Annual Photo Competition.

THE NEW METHOD OF FENCING.

F. SCHAVOIR, M.D.

President Stamford Fencer's Club.

From prehistoric times, when our hairy ancestors playfully let daylight into one another by means of stone knives and axes, the art of attack and defense has been of vital importance to the male half of the human race for the preservation of a whole skin and a more or less precious life.

The other and more beautiful half of humanity has also been highly interested in the art, not so much in an

natural, then, that during all ages the play of the sword should have formed an important part of every man's education, more especially if either by choice or general conscription he had to serve his country as a soldier.

The earliest swords of which we have any positive knowledge are bronze, though the Mexicans used wooden swords when the Spaniards first invaded their country. When the



Dr. F. Schavoir.

SALUTE

Lieut. J. M. de Zoldy.

active way, but rather as an interested spectator for whose benefit or favors the lords of creation would cut, slash or split one another with the most reckness enthusiasm.

Aside from these praiseworthy endeavors to cut one another's throat *pour les beaux yeux* of woman, the time is not far past when a man was frequently called upon to defend his property and his life against the gentry who made their living by whatever they could take by force. It is but

art of tempering steel was discovered, that material at once superseded all others, and it has maintained its supremacy ever since. In spite of all modern inventions nothing better has yet been produced, and a rightly tempered blade is a thing of such high quality that poets and prose writers have sung its praise, and extolled its virtues in innumerable instances. Romantic writers attribute to their heroes a love and affection for their sword which can only rank second to



FENCING POSITION.

the impassioned feelings they experience for their heroine. It is but natural that man should conceive an affection for an object which has stood by him in his hour of danger and trial. Have you ever noticed the affectionate, caressing way in which a fencer takes up his sword? It is not merely

a piece of steel to him, but a dear friend, on whom he relies, and whose intimate qualities he appreciates and understands.

The form of the sword has been varied from time to time, and according to the way in which it was intended to be used. The sword of the ancient



HEAD CUT (*PARRY QUINTE.*)



FLANK CUT (*PARRY SECONDE.*)

Greeks was about 2 feet long, either leaf shaped or straight, with 2 edges and a sharp point. It was a most useful arm, as it availed for either cut or thrust.

The ancient Roman sword was of about the same length as that of the Greeks, but the blade was always straight and the point shorter. As far as known, neither of these 2 great nations of antiquity carried the art of

fencing to perfection, but rather depended for success on shock tactics, and the hope of getting in the first blow. Every soldier was provided with a shield, and that in itself would preclude any fine sword play, which can only be developed by the meeting of blade with blade.

During the middle ages warriors seem to have depended more on the force of the blow than on the artistic



STOMACH CUT (*PARRY PRIME.*)

way of placing it. Swords were 4, 5, or even 6 feet long, with almost rounded points, and so heavy that 2 hands were required to wield them. That the strongest arm must win in such a contest is evident, and the art of fencing could not make any great strides forward. During the 16th century, however, the sword was narrowed and finer pointed, a better hand protection was provided, and the rapier was born.

Up to that time whenever a single handed sword was used, the other hand and arm were provided with

in time it was used only for the thrust.

From the East came the curved swords, such as the scimitar, yataghan and talwar, which proved most effective as cutting weapons. The advantage of a curved arm in a hand to hand skirmish was soon appreciated and made use of by Western peoples, and during the Napoleonic wars a much curved sword was used. However, as the point of the weapon was so much deflected from a straight line, it was almost useless for a thrust, and accordingly the curve has been gradu-

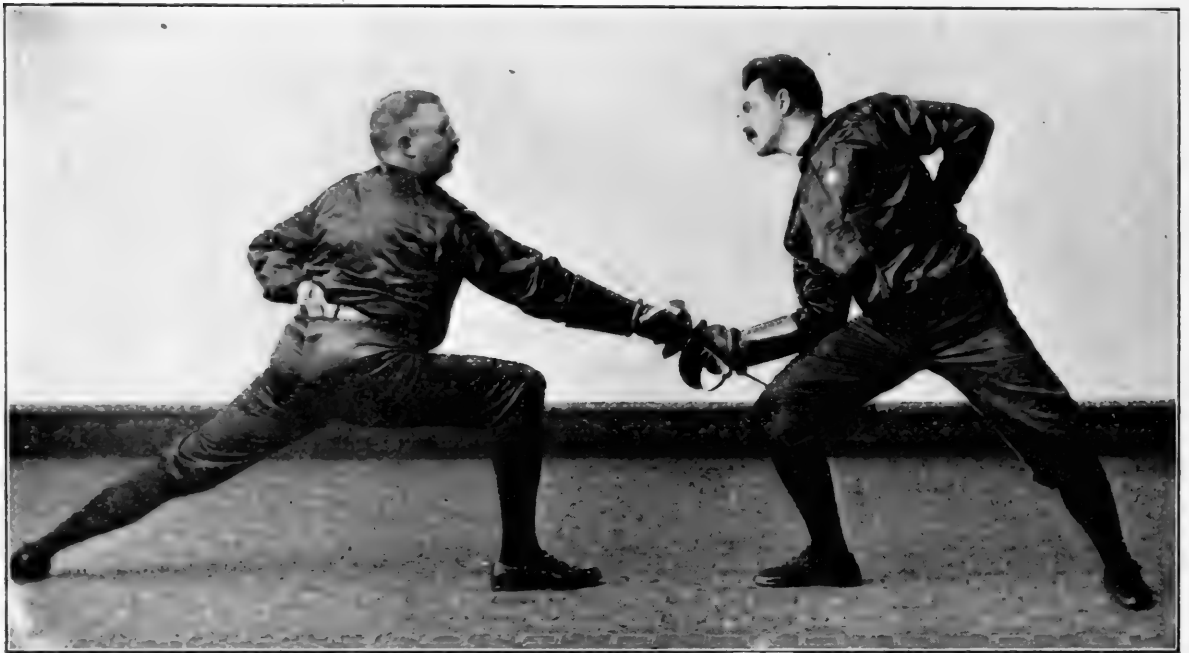

FLANK CUT (PARRY LOW TERZE.)

either a shield or a buckler. The shield was generally oblong or oval, 3 to 5 feet long, while the buckler was round and rarely over 2 feet in diameter. These parts of a combatant's armament were used to ward off blows and thrusts, and they were made of wood, hide or metal, or several of these materials combined. With the advent of the lighter sword and the rapier, parrying blows and stabs could be given with the weapon itself, and there the true art of fencing began. The rapier is a straight weapon, with sharp edge and point, and though at first used for cutting and thrusting,

ally diminished, so that but a slight deviation from the straight line is now noticeable. The modern weapon has one sharp edge, and a sharp, long point. This modern sabre is still further characterized by its lightness; in spite of which it is a most formidable weapon, and when handled by an expert a deadly implement. It can be used for cut, thrust or slash. It is a most convenient guard against either of these, and the dexterity which some acquire in its manipulations is nothing short of marvelous.

The home of scientific fencing in the earlier periods was undoubtedly

Italy. During the 17th and 18th centuries numerous schools flourished in that country, and almost every one of the larger cities had its own style of fencing, which was sometimes much at variance with other methods; sometimes only differed in minor details. Of course the weapon used was the rapier, or small sword, and only the thrust was attempted. Parrying was done with the blade or hilt of the sword, and sometimes a cloak or coat rolled around the left arm was used to parry or deflect thrusts. It is that method of fencing which inspired

and continued to be held in that country for a long period. England, Germany and other European countries took up the small sword reluctantly, considering it the arm of a weakling, but in recent times they have all attained marked proficiency. Since the beginning of the nineteenth century the broad sword was taken up, and its use spread rapidly, as it appealed to more energetic and aggressive natures. This weapon is about 3 feet long and the blade is $\frac{3}{4}$ to an inch in width, with one sharp edge and a moderately sharp point. It is used for cut-



STOMACH CUT (PARRY LOW QUARTE.)

Alexander Dumas, the father, to write those fascinating descriptions of the heroic exploits of Bussy, D'Artagnan, and numerous other characters in his unparalleled romances.

Another and more recent epic on fencing was written by Conan Doyle in "The White Company," of which Sir Nigel Loring is the hero, always ready to enter a sword contest, suggesting to his opponent that they might gain much honor and advancement from the encounter. In Spain Don Cesar de Basan is the hero of swordsmanship. During the 17th and 18th centuries the supremacy in the art of fencing passed from Italy to France,

and the principles of this style of fencing are simple and few.

Up to within the last 10 years there were these 2 methods of fencing: the small sword, or rapier, which was practised with the foil, and in which the thrust only was employed; and the broad sword, which confined itself to cutting. The German student, in order to satisfy his craving for gore and glory, employs a hybrid arm, called the Schlager, which has the shape of the rapier, or straight sword, but is used like the broad sword for cutting. Its field of usefulness is limited to the head and face only, probably because that part of their anatomy is the hard-



CORPS A CORPS. (FILO IN TERZE.)

est to penetrate; for, mind you, they do not wish to inflict any harm on each other! They are generally the best of friends, before and after their *mensur*, and except for a few drops of blood and a few gashes in the skin their encounters would be as harmless as a modern French duel.

Within a decade a new style of fencing has been introduced from Italy, which once more takes back to that country the supremacy in the art. It is called the Italian sabre, and its merits and superiority were so readily recognized in Europe that every country which takes any serious interest in the art has adopted this method. The governments have introduced it into their military academies and regimental fencing schools. This method is as much superior to the older ones as the electric light is to the old tallow dip candle. It combines everything that was useful and practical in the several older methods, and adds to this a variety of combinations and scientific calculations, which were out of the question with the older styles.

It seems remarkable that it should have taken centuries to evolve a method which appears so obviously better, when once understood, yet it is with

this as with as many other things, "like the egg of Columbus." Chevalier Luigi Barbasetti was one of the first to introduce the new art abroad. He opened a fencing school in Vienna and soon he was busy from morning till night teaching the new method to officers, cavaliers and representatives of the upper classes. The new school jumped into vogue and renown at once, and it became the proper thing to go to Barbasetti for tuition.

Mr. J. Marczy de Zoldy was one of the most promising pupils of the now famous master, and the numerous medals he has won attest the benefit which he derived from the instruction.

In this new method, the position which the fencer takes is derived from both the older styles. While in small sword or foil the knees were bent, and an almost sitting position assumed, with the left arm raised back of the head, in the broadsword and cutlass exercise the knees and legs were almost straight, though separated, and the left arm was held behind the back, gripping the belt in the center. In the new method the knees are bent and the left hand held behind the back, hooked in the belt, combining thereby

the useful points of both the old styles and eliminating the awkwardness of the left hand over the head and the stiffness of the legs.

Another important distinction between the old and the new method of sabre fencing is the use in the latter of a remarkably light weapon, avoiding thereby the fatigue which results from even a short bout with the old style sabre. The modern blade is hardly one-third the weight of the older kind, the hilt is proportionately lighter and a fencer, after a little training, will be able to manipulate his weapon a long time without fatigue. Aside from the reduction in weight, there is an inconceivable advantage of more subtle manipulation, permitting a much more accurate direction of cuts and thrusts. The grip on the sabre is not in the palm of the hand, as with the old clumsy weapon, but between the index finger and the thumb, the other 3 fingers simply steadying the hilt against the palm of the hand. In this way the fencer has the point of his blade under perfect control. He can feel it, so to speak, and can direct it with an accuracy unattainable with the old style grip. This sensation of accu-

racy is called the *doigté*, and when once acquired will allow of the most subtle sword play. As a blow with the flat of the blade would count for nothing in an actual contest it should be the fencer's endeavor to prevent the flat blows with the sword, but with the old style grip it is almost impossible to avoid them, while with the modern weapon they occur but seldom and are considered a disgrace to the fencer who perpetrates them. The true art in fencing is the placing of a cut or thrust accurately and in correct form. The clumsy tyro will hit as hard as he can, while the master of the art will touch gracefully and with just sufficient force to inflict a serious wound were the affair in good earnest.

The points of the body to be attacked are 5 cardinal and 7 minor ones. The top of the head is the first point, and is reached by the straight downward cut; the sides of the face on the right and left are the next 2 important points of attack; then the flank, that is, the right side of the body, and last the front of the body, which is turned to the left, down to the waist.

The minor points to be reached are



THRUST.

the neck on either side, the flank and body, high and low, and the right arm. For each cut there is a parry. Everything aimed at the left side of the body is parried in "*Prime*;" at the right side of the body in "*Seconde*;" at the right side of the face, when the sabre points upward, the parry is in "*Terze*;" and if aimed at the left side in "*Quarte*." The parry for head cut is in "*Quinte*," and the sabre is held high, pointing forward.

There are several auxiliary parries, sometimes called emergency parries, such as low *Terze*, low *Quarte*, or the *Sexta* and *Septime*, which latter 2 protect the head and face.

After each parry there is a *riposte*, that is to say, a return cut, and in this way cuts and thrusts are exchanged until one of the contestants is hit, which he announces with the word "*Touché*." The thrusts are essentially the same as those of the foil, besides the combinations with cuts which enlarge their application to an infinite variety. To place a simple cut or thrust and make it reach its objective point is the most perfect art, but this is so difficult that feints are resorted to; that is to say, the attack is initiated with several cuts or thrusts which are not finished, but induce the opponent to lay himself open at a certain point; and to see that point and send home the edge of the blade is the final object.

One of the finest points of this new method of fencing is the possibility of making calculations in such a way as to place a *touché* after 2 or 3 parries and *ripostes*. After the second *riposte* the attack is called in second intention; after the third, in third intention, etc., to any length, according to the skill of the fencers.

A number of physiological as well as psychological facts have been made use of in this method, such as *tempo* attacks, that is, the choice of the right moment to execute certain motions; and fractions of a second are important factors.

To describe adequately this method would require a book, and a good *exposé* of it has been written by Mr. J. M. de Zoldy, which is now in press.

The question arises, Of what benefit can be the acquiring of an art, when nobody but a military man carries a sword, and when duelling has become obsolete, at least in Anglo-Saxon countries.

In continental Europe even to-day the sword is the final arbiter of differences between men of the upper classes, especially among officers of the armies and navies. Whenever one man feels so aggrieved by another that a simple explanation or apology can not be accepted, or is not offered, he has a right to challenge that person, and such a challenge is a formal affair, indeed. In the first place, the aggrieved party chooses from among his friends or acquaintances 2 men to act as his seconds. These visit the person to be challenged, make him acquainted with their errand, and ask him to designate his seconds. After this the affair is entirely in the hands of these 4 men, and it is their first duty to try to adjust matters in an amicable way. Should this prove unfeasible or undesirable, the details of the duel are arranged, weapons chosen, time and place for the encounter appointed, and preparations made for the care of the wounded.

In military circles a court of honor is appointed by the commanding officer, and its decisions are final. Should a person decline to fight, after his seconds have decided that he should, or in case of an officer after the court of honor has authorized the duel, he would be declared without honor and shunned and ostracized by people of his usual surroundings. If an officer, he would be asked for his resignation, and should that not be forthcoming he would be cashiered, as every other officer of his regiment would decline to serve with him.

We may think these usages barbar-

ous, and not in keeping with the advance of civilization, and some of their features certainly savor of mediæval times; but there are some good points also in this custom. With the equalization that is given by the sword between men of different build and physique, the weaker man has, if skillful, an even chance with a man of more powerful build, and the big, brutal bully has no advantage from his greater strength.

ing factor, but because it is a chivalrous sport in which every consideration is shown the opponent. Never would a fencer think of taking an unfair advantage of his adversary. Should one by mischance drop his sword, or make a misstep, the opponent at once lowers his weapon until his antagonist has regained his proper position. An unfair blow is a disgrace, unless a proper apology is at once offered. Courtesy and fair play



HEAD CUT (PARRY SEXTA.)

As any act of boorishness, coarseness or unprovoked insult is bound to see its perpetrator called to account, men become most careful in their dealings with one another, as sometimes even a sneer is sufficient cause for a challenge

According to statistics published November 14th, 1903, there were 6,000 duels fought in Germany during the preceding 12 months, 22 of which resulted fatally

Fencing is, therefore, conducive to good manners, not only as a restrain-

are *sine qua non* conditions of fencing. That this sport tends to make its adepts graceful and self possessed has often been observed, and there is no better exercise to overcome awkward self consciousness or clumsiness. As a means of self defense, fencing is important. A fencer armed with an ordinary walking stick can easily keep at bay one or 2 assailants, even if similarly armed; and it is out of the question that if attacked with fists only a moderately skillful fencer should not come out victorious from



OUTSIDE CHEEK CUT (PARRY SEPTIME.)

an encounter with 2, or even 3, men not conversant with the art.

It has been noticed in all times that men who devoted much of their time to fencing were usually healthy and robust, their muscles were strongly developed, and they were hardy and capable of enduring great fatigue. Bodily health and vigor are what we are looking for at all times, and it is the opinion of those well qualified to speak with authority, that fencing is the exercise *par excellence* which invigorates and produces a stalwart frame. It gives to its devotees a carriage which no other exercise will produce, coupled with gracefulness of movement and self reliance expressed in every attitude. The eye is trained and quick decision is learned. Every muscle of the body is brought into play, and the blood circulation is stimulated to a maximum. Chest expansion is improved to a remarkable degree, and every normal function of the body is brought to its best standard. A good appetite, good sleep and general good health are some of the

rewards which can be obtained from fencing.

As a sport, fencing can bear the most critical comparison with other exercises. There are a number of



FINALE.

methods of physical training, which, if faithfully and persistently carried out, will produce great bodily advantages; but the trouble with them is that not one in a hundred persons will persevere with them. Though faithfully performed for a short time after they are taken up, they soon become burdensome and are consequently neglected. The reason for this is that they do not appeal to the mind; they are simply and purely physical, and the mind has absolutely no part or interest in them.

Not so with fencing. Here is an exercise which, though requiring the most strenuous physical effort, has to be guided by the mind, and guided with intelligence, acumen and decision. Not one moment of indifference or inattention is permissible. That is what makes fencing the sport of brainy men, and fascinates its followers. It is a mental relaxation because it demands concentrated attention, and thereby diverts the mind from the ordinary worries and thoughts of humdrum existence. The sport is refined, because it precludes roughness or brutality; it equalizes between the most diverse personalities. The short man is a match for the tall one, the slight for the strong; and skill is the only factor which bears weight in sword play.

The stimulus of personal contest between man and man is one of the most attractive features, and a bout between evenly matched fencers is a sight worth seeing. With it all, there is an entire absence of danger from personal injury, the head, body, arm and hand are effectively protected, and after the most spirited passage at arms there will not be found a scratch on either contestant.

The entire absence of roughness makes it essentially a sport of gentlemen, and in late years women of refinement have taken up fencing with great benefit and no drawbacks.

Our President, who is certainly a model sportsman, has taken an interest in and is learning the art. In diplomatic circles in Washington it is practised assiduously. In Europe, fencing as a sport is enjoying a great revival, thanks to the new school, which has revolutionized the old, worn-out methods.

It is to be hoped that men of leisure, as well as professional and business men in this country, will give this sport the attention it deserves. Those who will try it will persevere and those who persevere will be rewarded beyond their expectations with health and enjoyment.

HARD EGGS.

GEO. A. WILLIAMS, M. D.

I buy some egg on hardware store,
 Maybe she was some bone;
 Two day, two night, she cook all right,
 She was so hard like stone.

I put him on some hen for set,
 Maybe she hatch bimeby;
 I leave him stay 'bout sixty day,
 Dem hen, she almos' die.

I'll tink dem egg she was too hard,
 Maybe she was too old;
 Dem hen she sneeze, she almos' freeze,
 She catch so much bad cold.

I take some ax for break dem egg,
 She knock him on stone wall;
 For 'bout half day, I work dat way,
 She nevare break at all.

Dem egg she was so awful hard,
 I'll don't like any more;
 She make me mad, I feel so bad,
 Like I nevare was before.

ON SNUBBING.

E. J. MYERS.

How to snub, or even check the rush of the salmon is the most difficult of all things connected with salmon angling.

The only large salmon I ever hooked and played, one clearly over 40 pounds, I lost by snubbing; i. e., checking and restraining the outgoing line. The fish in briefest instant broke a 14 pound dry strain leader.

Several times have I tried it and disaster has come every time. It inevitably obtains that you must give the salmon his head and follow him until he quiets, whether it be a mile or miles away. Sure as fate if you snub, something gives way. If the fly does not tear out, the leader, line or rod will break, the canoe will capsize or you will fall down, and the salmon will escape. Some link in the chain of causation breaks, and mourning follows.

I was fishing on the reefs at the upper pool of the Overfalls on the Grande Codroy, at the head of which is a heavy rush of water in which it is difficult to hold a large fish, while below are the treacherous sluices and boulders where the line must come to grief if the salmon gets out of the basin. There it is that you are between the devil and the deep sea; and there, with knowledge of these facts, I cast and hooked the salmon of all salmon that have ever been on my line. Pat Downey affirmed it was the largest he ever saw dead or alive. Pat knows a thing or 2 of size, for what there may

be of torch and spear, which surely kill the big salmon, that Pat has not practiced, I can not imagine.

This salmon showed himself as he rose and fairly wallowed on the surface with a swash that sent the waves to my feet, and started for the sea with a rush that made the reel scream. Once and twice I checked and held the fish in the pool by giving the butt a-la-Davy Humphry. Then came the seaward start that means the next pool, if not lower.

My only hope of saving the fish was in holding him in the basin-like pool barely 30 yards long and half as wide. I threw the rod into position and put my fingers on the reel spool just before the salmon reached the end of the pool. Immediately the rod broke at the ferrule between the second joint and the butt, apparently its strongest part, but in fact at the only weak point in the tackle, and in the disaster the reel fell off the rod. That is why I don't believe in patent locks but take a bit of string for safety.

That salmon may be going yet, the presumption being that the fact once shown still continues, and certainly no salmon with that fly in his jaws has been landed on the Grande Codroy.

In sinking the wood into the male ferrule, a space scarce 1-32 of an inch had been left between the wood end of the butt and the female ferrule, and there, notwithstanding the metal band, it unaccountably broke.

"They have called in 2 doctors for consultation."

"And do the doctors agree?"

"I believe they have agreed on the price."

—Philadelphia Ledger.

AMONG THE ISLANDS OF GEORGIAN BAY.

MAY BRAGDON.

One pleasant July day we left Toronto at noon, starting Northward toward the alluring shores of Georgian bay. The railroad ride was not tedious, but it was a relief to reach Penetang, embark on the steamer "City of Toronto," and start off comfortably in the cool breezes of a summer afternoon, past log booms and rafts, dainty sailing craft, picturesquely ugly dredges and tugs, to the wilderness beyond.

Yankanucks from Pittsburg, flying both flags, and a cozy looking point in the early lamplight called Sans Souci.

It was starlight when we reached Rose Point and Parry Sound, the little metropolis of the Thirty Thousand islands. There we spent the night, and early in the morning, as the "City of Toronto" backed silently away, we heard the distant whistle of the "Britannic," which came to take us



BY COURTESY OF THE GRAND TRUNK RAILWAY.

GEORGIAN BAY DISTRICT.

It was an afternoon and evening of delights sailing among wild little wind-tossed islands, lagoons like those of the South seas, breakers and rollers sometimes, and smooth land-locked harbors, with the signs of habitation few and far between, but charming. We passed a University club settlement at Go-Home bay, a pleasant club of

still farther into that unknown Northland.

Soon we reached the open. Gulls circled around and raced our ship; barges towed by sturdy tugs, loaded schooners and steamers, showed that we were in one of the highways of the lakes. The fresh, strong breeze and the sparkling sunshine were intoxicating. As we came in among



BY COURTESY OF THE GRAND TRUNK RAILWAY.

GO-HOME BAY AND CHANNEL. GEORGIAN BAY DISTRICT.

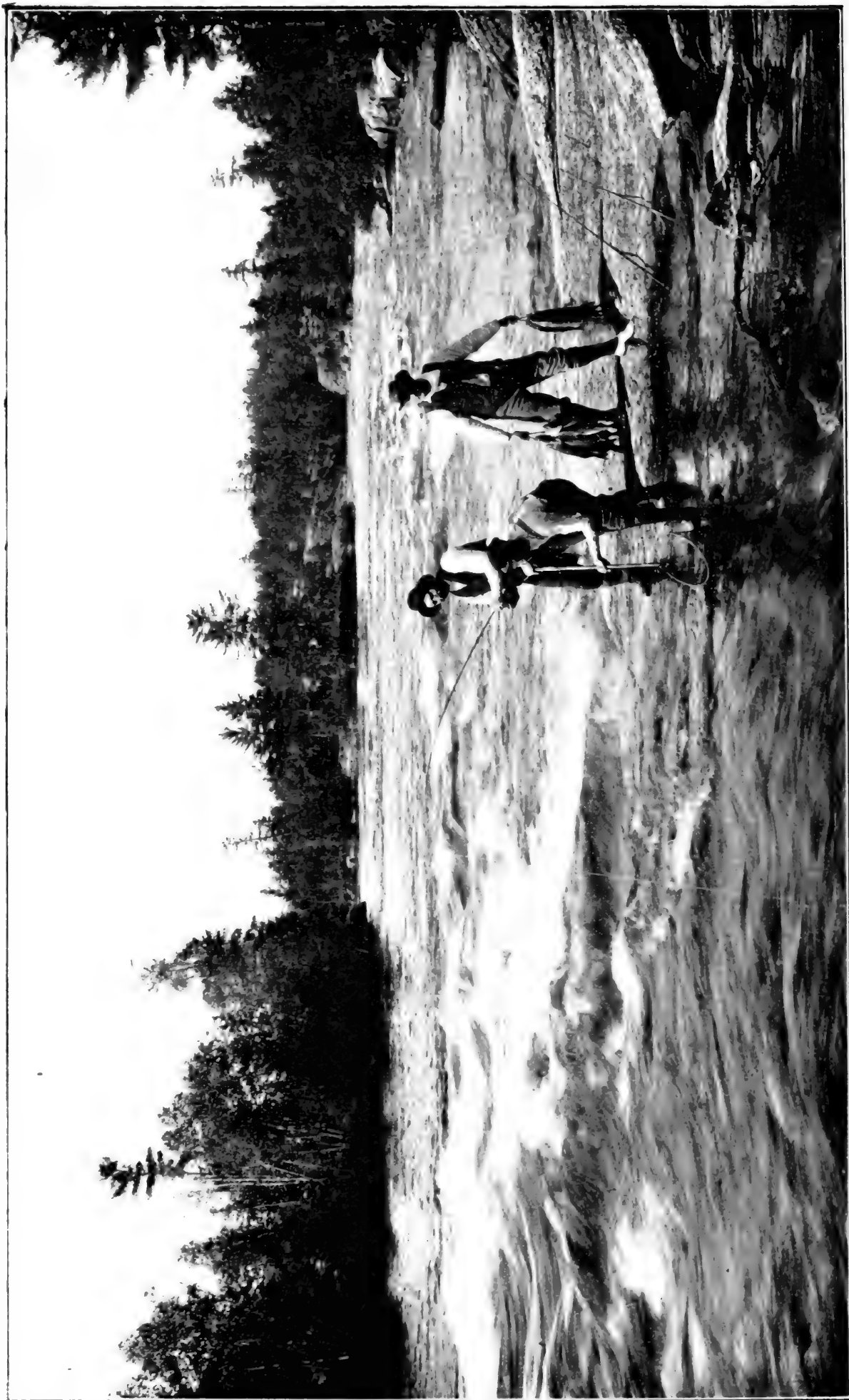

BY COURTESY OF THE GRAND TRUNK RAILWAY.

ON THE FRENCH RIVER.



AMATEUR PHOTO BY M/V BRAGDON
THE ISLAND OF ST. HELENA STOOD
REVEALED.

the islands again, we found them wild, beautiful and apparently untrodden by the foot of man. The breeze wafted odors of pine, spruce and cedar; one forgot the world behind and the cares of every day. The next event of the day was dropping

stead of into the friendly security of "The Little Corporal," as the biggest skiff is called.

We spent days and nights of unalloyed happiness among those beautiful islands, with daily sails in the channel and across the open water to Point au Baril, which consists of a lighthouse, a prosperous fish dock and store, 2 or 3 houses and a hotel. There were also excursions to Hemlock or down Sturgeon bay to fish, sails to Hang-dog Point, long paddles among the unexplored channels of lovely island groups, "island shopping" excursions, for everyone who comes to these glad lands has a longing to possess, and the islands are as cheap as they are beautiful, and picnics on the rocks, where the cares of earth are far away, and one feels small in the bigness of the world.



NEAR POINT AUX BARIL. GEORGIAN BAY DISTRICT.

BY COURTESY OF THE GRAND TRUNK RAILWAY.

off from the "Britannic's" lower deck into the trembling maw of a little skiff; and as the big boat moved away the island of St. Helena, the end of our journey, stood revealed, looming hospitably above the sparkling waters of Bonaparte bay. The lively house party on the dock welcomed the new arrivals with congratulations, for they expected, it seems, to hear us gurgle as we dropped into the waters of the channel, in-

We enjoyed the moonlight nights, the stars, the weird Northern lights, and the long mornings of blueberrying, raspberrying and gooseberrying. Nature fed us. The bass bit below our rocks; the muskallonge followed our shining troll. The Indians knew where the frogs' legs grew, and said that in season wild ducks sell for 10 cents apiece, or you can shoot them yourself; while venison is 4 or 5 cents a pound,



MORNING SCENE AT POINT AUX BARIL. GEORGIAN BAY DISTRICT.

BY COURTESY OF THE GRAND TRUNK RAILWAY.



30,000 ISLANDS, GEORGIAN BAY, ON THE BOYNE RIVER.

BY COURTESY OF THE GRAND TRUNK RAILWAY.



AMATEUR PHOTO BY MAY BRAGDON.

THE SURVEYOR'S BRIDGE.

and bear steaks, smothered in onions, are cheap and good.

A fisherman's wife at the Point made us good bread, and the lighthouse keeper kept also a cow. Each evening, when he came to the range light a mile down toward St. Helena, he brought our big pail of milk, left it in a barrel on the shore of the island, and it was our nightly pleasure to row up at sunset, get the milk and leave an empty pail.

Though the Point was a mile and a half

away, and there was only one other shack and a surveyors' camp nearer, we were never lonely, for the house was always full, and Bonaparte bay faced the channel, where all sorts of fishing craft, lumber tugs, freight boats, pleasure yachts and 4 times a week the big "Britannic" passed. Sometimes the picturesque Ojibway Indians silently paddled by at evening, outlined against a primrose sky; and dear, big hearted Canadian friends came often, laden with baskets of good things to picnic somewhere with us, or sit around our fire, or dance on our piazza to the tunes of an Indian's fiddle. More than once friends from the Point were stormbound there. Then cots, hammocks and tents overflowed, and everyone helped bake pancakes in the morning on the merry little Klondike stove.

One year before, this place was a wilderness. Saint Helen herself was only a fishing guest up at the hotel, with Him and his Wife for chaperones; but they bought an island, and she bought St. Helena—2 or 3 acres, with rocks and woods, a jungle, hills and ravines, bays and promontories—all for a song. A little American hustling, with a big brother to go up in the spring and assist, built the pretty shack, the cost of which, including the island, was less than

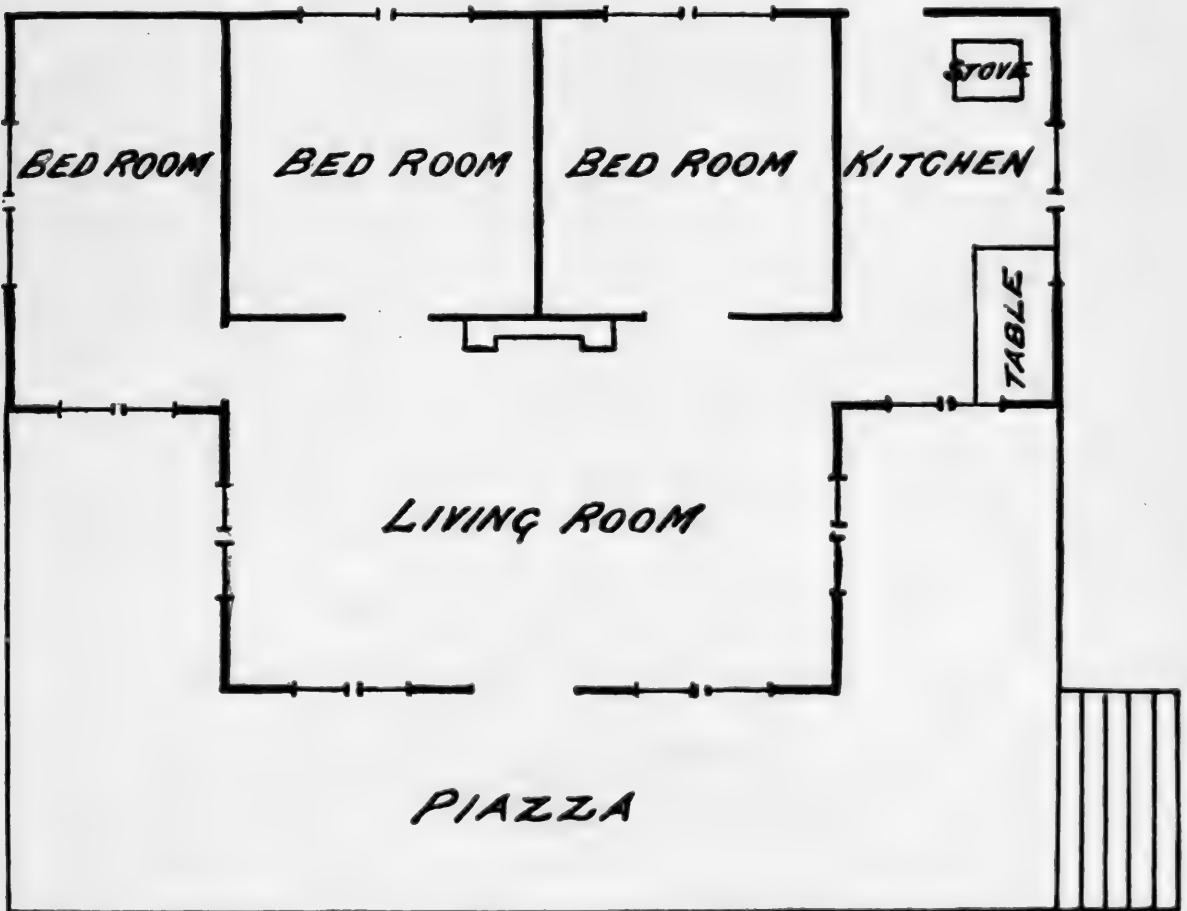

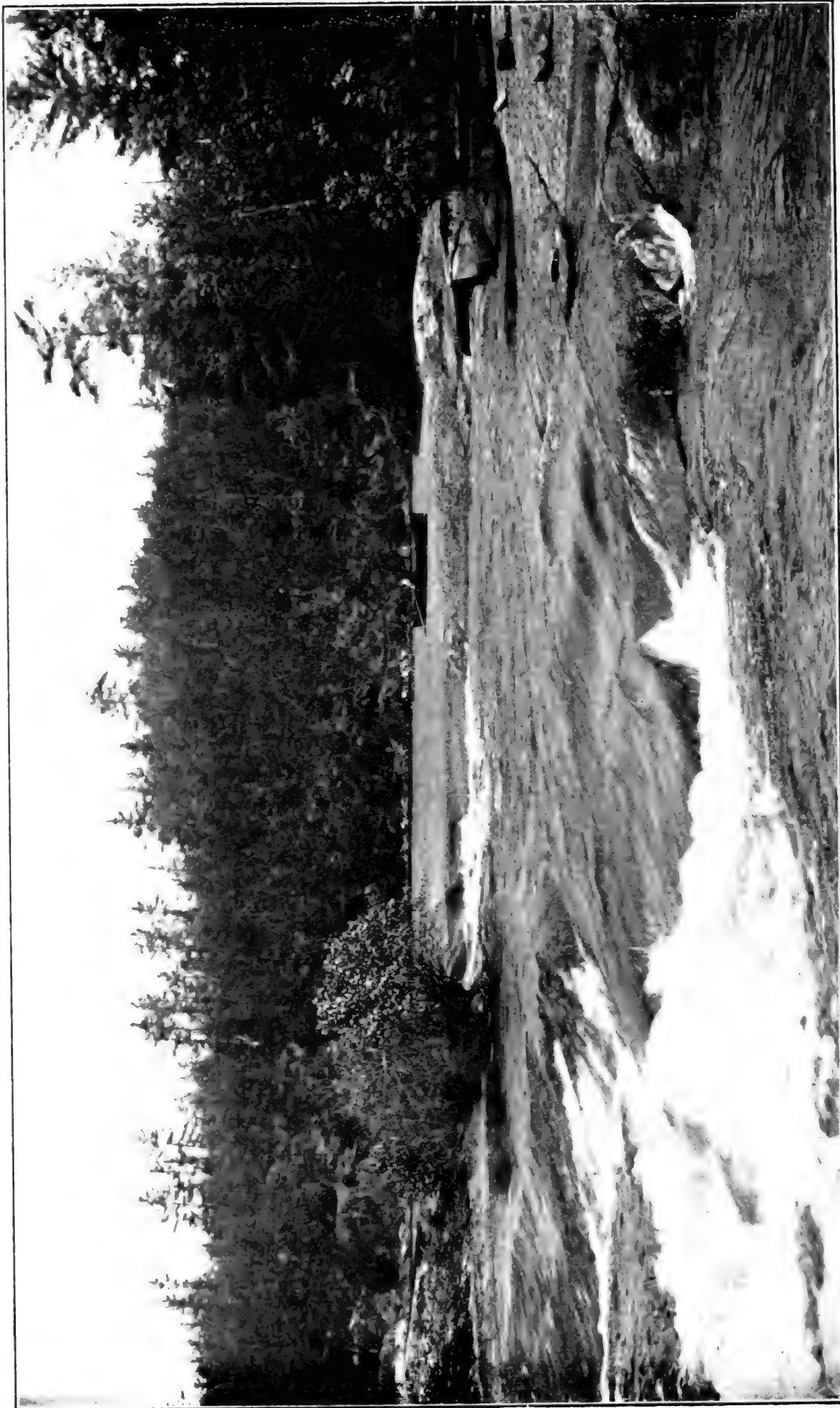

BY COURTESY OF THE GRAND TRUNK RAILWAY.

FRENCH RIVER, LAKE NIPISSING DISTRICT.

\$300! Lumber is cheap up there, and so is Indian labor.

A generous piazza surrounds the living room, which is all windows. There is no ceiling but the roof, with a dormer up toward the peak in front, to let in more light and air. The furnishings are simple but pretty and appropriate. The bread box is covered with a steamer rug and serves as a divan beneath one window. The china closet, made of a box lined with green paper, is filled with blue and white dishes and German brown ware. One touch of elegance is Napoleon's bust, adorning a shelf; and a rustic corner desk holds the birch bark guest book. The sofas are cots, with many pillows, and are always available for chance guests over night. The crowning luxury is a red brick fireplace and chimney gracing the place of honor opposite the front door. There are 2 square bedrooms behind the living room, with 2 cots in each. The wide windows open to the woods, and the partitions extend only half way to the roof. Another bedroom at the left behind the piazza, and the kitchen, or galley, at the right and opposite, complete this gem of a house. Saint Helen reigns supreme, and all her guests are happy.

PLAN OF ST. HELEN.

Behind, paths are carved through the jungle, rustic seats are built on distant rocks, bridges are planned across ravines and chasms, and although coming years may transform this lovely spot into something nearer perfection to most eyes, the charm of this first year of pioneering will never be excelled.

Other people have bought surrounding islands. All F and G groups are gone and H is fast disappearing. The artist has named hers Mandalay and the Ph. D. has a Wonderland. The skipper is putting a shack on Oneishta, and there is to be a log cabin on the surveyor's rock. It is even rumored that a man from New York is to build a 2 story house somewhere across the channel! and Him and his Wife, around the corner at Duazyupleze, are to have a real steamer dock, where the "Britannic" may stop!

It will change, but it can not lose its charm. The sweet winds will always blow; the white winged gulls will circle there; the happy beasts will not go far away; the clouds and sun, the clear, cold, water and the painted rocks can not change. The happy isles are there forever, and as the summers go the memories will remain.

I GO A-FISHING.

R. S. STRINGFELLOW.

Somewhere I have read of an angler,
Who gained a wondrous fame.
He lived in the land of Israel;
St. Peter was his name.
"I go a-fishing," he said one day
To his friends in Galilee;
"I go a-fishing." So says the Book;
And off he went with line and hook,
A-fishing in the sea.

Since then along that storm-beat shore
Many a wave and billow roar;
And in the rush of wave and blast
Many a life has breathed its last.
But still the anglers go!

"I go a-fishing," 'tis often said,
Although St. Peter's long since dead.
But the words of this reverend saint and sage,
There on the good Book's sacred page,
Live on and on from age to age,
And still the fishers go!

"I go a-fishing!" Three fishers, this time,
Will be the subjects of my rhyme.
'Twas in midsummer's sweltering days;
The sun beat down with scorching rays,
When off to the West these fishers went,
With heart and mind on pleasure bent,
Away to the West, these fishers three.
With jocund song, right merrily
They pass the time away!

"I go a-fishing!" Three fishers bold
Now emulate the saints of old.
To mountain stream and shady nook,
Afar with rod and line and hook.
They make their way; through hot sunshine,
To where, 'neath shady cliff and pine,
They hope, if fortune prove so kind,
On speckled trout they soon may dine!
So lived the saints of old!

"I go a-fishing," now each one said,
"The spot we've reached and camp is made";
And soon beneath the cooling shade,
With boots waist-high, the stream they wade!
The joyous time flies all too fast,
While here and there with fly they cast;
And in each boiling crystal pool
Some wily trout would play the fool—
Much to the angler's joy!

But all too fast the moments fly,
The time has come to say good-bye.
Back to town and dusty street,
Back to sun and sweltering heat.
But memory sweet shall still be mine,
I'll think and sing, of auld lang syne;
And the good old angler of Galilee
My guardian saint, I trust, will be!

PRANKS OF PORCUPINES.

G. O. SHIELDS.

As a worker, the porcupine ranks next to the beaver in the quadruped creation. No obstacle seems to balk Mr. Quilly in his efforts to obtain salt or grease, and the things he does in pursuit of these dainties are almost beyond belief. The facts I shall relate, however, can be verified by hundreds of men who have camped in the woods where this little rodent makes his home. Many a man has been compelled to get up in the night and club these intruders out of the tent to avoid having his shoes, his gloves, his hat, his bacon, his salt bag, or other property destroyed. The porcupine seems to know no such impulse as fear. He takes it for granted that he may go anywhere in search of food or of delicacies; and even after being whacked across the nose with a stick, or kicked out of the tent, he will return and continue his depredations, time after time. He seems not to have sense enough to take a hint, unless it be emphasized with a club laid on so vigorously as to inflict serious bodily injury, or even to cause death; yet in other respects he is exceedingly cunning.

It seems a pity that so ingenious an animal as the porcupine should not have sufficient fear of man to keep out of his way; but poor Quilly is sadly deficient in this matter, and, as a result, his bones and his quills lie in bunches about almost every camp ground in the Northern States and in Canada. Many men and boys take delight in murdering these poor beasts in cold blood, and when attending to their own affairs. Others, as I have said, are almost compelled to kill them in order to get a chance to sleep, or in defense of their property.

I have known porcupines to eat almost a whole axe handle that had been swung by sweaty hands and then left about some old, deserted camp. I have frequently found the remains of pork barrels and salt barrels that have been partially eaten by porcupines, in order to get the remnant of salt or grease which the wood contained.

Two of my friends who were camping in the Selkirk mountains caught a young marmot, took him to camp and put him in a box, with a view to carrying him home. The slats which the men put over the front of the box had formed part of a packing box in which bacon had been carried. The cage was left outside of the tent and in the night a porcupine came along, ate the slats and liberated the marmot.

A man who was working a mining claim near Rosland, B. C., lay down under a tree, after lunch, to take a nap, and placed his hat over his eyes to shelter them from the light. He was tired and slept soundly. A porcupine came along and ate nearly all the leather lining out of his hat before the prospector awoke.

Another quill pig visited W. H. Wright's camp one night, and smelled bacon grease on the sheet iron stove; whereupon he proceeded to gnaw. The racket disturbed Wright and his partner, when the former got up, took the poker and threw the intruder out. Then Wright went back to bed, but within 5 minutes Quilly called again and resumed operations. That time he was boosted out more energetically than before, and was thrown into the creek, which ran near the tent. He floated off down the stream, but Wright had only got comfortably asleep when the everlasting rasping was resumed. Then the campers grew wrathful, and one of them got up and killed the chairman of the investigating committee.

Dr. Schavoir and his wife camped in the same place the next spring, and during the 8 days they were there were compelled to kill 27 porcupines in order to save their grub and clothing from destruction. One of their visitors attempted to cross the creek one night to reach the tent. He walked out on a log that extended part way across. When he reached the end of it he seemed to dread a cold bath, yet was so anxious to get across that he sat there and whined several hours. Finally the guide got up and killed him in order that the campers might sleep.

The cook employed by this party hewed out a trough, from a big log, which he used as a wash tub. Having for the moment forgotten the ravenous appetite of the porcupines, he put the washing to soak over night, and in the morning found that a sleeve had been literally eaten out of one of the shirts. It is supposed that the porcupine found some remnant of the salt flavor of perspiration in the sleeves; or, it may be there was something about the soap which suited his taste.

The members of this party were compelled to hang up all their food, clothing, boots, shoes, saddles, cartridges, belts and everything else that had leather about it, or that had been handled enough to have any flavor of salt or grease on it.

Wright developed some photo negatives

one day and left a bit of fixing solution in a crock, outside the tent. A porcupine came along in the night and drank this up clean. They did not find him, so it is not known whether he was well fixed after taking his medicine.

In this connection I reprint a portion of an article on the porcupine which was written by S. N. Leek, of Jackson, Wyo., and which appeared in *RECREATION* for June, 1900:

Some years ago it was a common occurrence to have to catch both cattle and horses and pull porcupine quills out of their noses or out of the heels of the horses. They probably would try to smell Porky and get within reach of his unerring tail. This led ranchmen to kill all the porcupines they saw, which has materially reduced their numbers. I have seen a horse step on a porcupine in a trail overgrown with grass and get all his legs full of quills. Once a friend dismounted from his horse to photograph a Porky. The beast made a break for cover, which happened to be the doctor's horse that was quietly gazing near. On feeling something prick his leg the horse struck out and kicked poor Porky, transferring the quills to his own legs.

One spring while hunting bear at the foot of the Teton mountains I saw more porcupines than ever before or since. We usually put everything they could harm in the tent, but one night, coming in late, I forgot my saddle. They didn't eat it quite up, but nearly so. The next evening, in walking around camp, I met 8 of them coming in to finish the saddle. Of course I turned them down.

One day while going along the road I passed the carcass of a horse that had died the fall before, and there were 8 Porkies gnawing at the bones. Farther on I saw 10 of them at work at one time on the bones of an elk.

I put in a small saw mill at the foot of the Tetons and there we had trouble with the porcupines. We could not sleep while one was gnawing at the corner of the house. We would stand it as long as we could; then someone would get up, steal outdoors and whack him. It is wonderful what pounding they can stand. One night while alone at the mill I killed 7, and about mid-

night I got 3 more. The first one in front of the door on the porch gnawing. I got him. Then I heard one on a big box beside the door. He was eating a saddle blanket. I got him also, and was about to go in when I nearly ran my face against a big one clinging to the porch post, on a level with my head. He gave me such a start I missed him with an iron rod I had and nearly knocked the post out, but I got him the next trip.

We never found anything they wouldn't eat. They gnawed the whole end off the little porch we had on the house. At the creek where we washed they took the soap we left lying on the bank. A bar of soap just makes a porky a lunch. All tools had to be put in the house or the porcupines would eat the handles; and for saddle blankets or harness they had a weakness. The men working the road had their shovel and pick handles gnawed, all over and the plow handles nearly eaten up by porcupines. A man who left a wagon box on the Teton pass had one corner of it eaten entirely out and a hole 18 inches across cut through the bottom.

In skinning bears, mountain lions, lynx, wolverines and coyotes I have found porcupine quills embedded in the flesh. Once in skinning a mink I found him full of quills; but he had probably got too close by mistake. I have seen dogs get quills in them by rolling where a porcupine had been killed.

The porcupine makes several different noises. One is a sort of singing made when the old and young ones are out together. Once I slipped out from camp about sundown, with my rifle, across a small meadow and through the woods 300 or 400 yards, after a strange calling noise I heard, to find it was a porky who was probably lonesome.

I have seen these animals voluntarily swim a creek 75 feet wide. They seem to hear better than they see. A porky will either raise his quills and sit where he is, disdaining to run, or will make for cover, get to a log, stick his head under it and flirt his tail at anything that comes within striking distance; or he will climb a tree.

Verily, the quill pig is an amusing little cuss.

"Have you submitted this poem to anyone else?"

"No, sir."

"Then where did you get that black eye?"

—Life.

AN APOSTROPHE TO MY CANOE.

R. R. KIRK.

White Princess, over glistening wake
And brave appointed fish, and all
Swift moving things, which in thy wake
Flash and follow, mount and fall!
O lithe craft, most fair art thou,
Wherever water passes prow!

Where water swiftest runs, and cool,
Where willows bend above the stream,
Where fishes leap from darkening pool,
Thy whiteness and thy jewels gleam!
Akin to running streams art thou,
O fairest boat, with stateliest prow!

Now lingering in the inviting shade,
Now swiftly following fancy's flight;
Impatient to obey the blade,
Imperious urger, day or night;
O, swift and sweet art thou, Canoe!
On many a rivulet proven true.

Of lightest cedar sawn; by deft
Skilled fingers shaped, and truly made
Complete and beautiful; bereft
Of all unloveliness, and arrayed
Befittingly art thou, Canoe,
Who builded better than they knew.

For wast thou not a spirit first,
Ere yet they made for thee this shell?
I know for waters thou dost thirst,
Where plash of fish is heard, where
 dwell
Wild creatures,—even as I who now
With dripping blade guide thy swift prow.

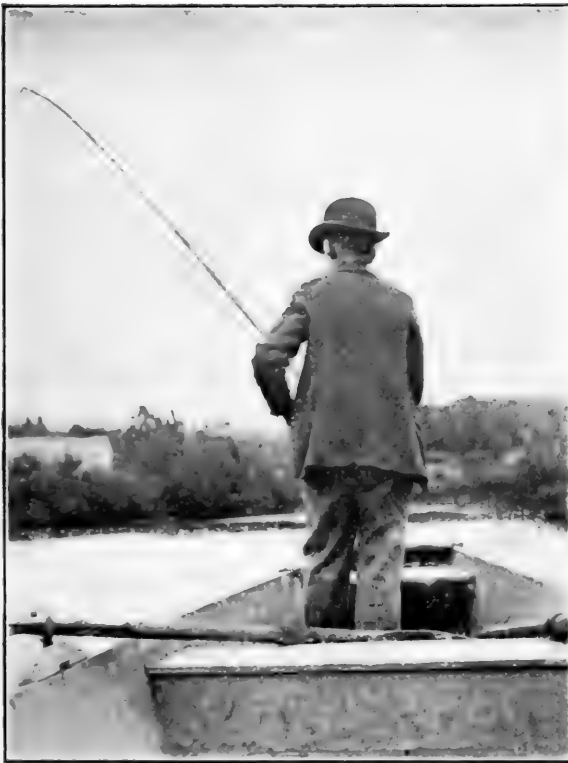

AMATEUR PHOTO BY C. M. WHITNEY.

I'M BUSY.

Winner of 52nd prize in RECREATION'S 8th
Annual Photo Competition.

One of the novelists, referring to his
hero, says:

His countenance fell.
His voice broke.
His heart sank.
His hair rose.
His eyes blazed.
His words burned.
His blood froze.

It appears, however, that he was able to
pull himself together and marry the girl
in the last chapter.—Exchange.

“Yes, we’re going to be married.”
“Have you proposed?”
“No, not yet.”
“Then how do you know she’ll have
you?”
“Why, she’s been encouraging me to save
money instead of buying flowers and the-
ater tickets.”—Chicago Evening Post.

There was an old monarch in Thibet,
Skirt dancing he tried to prohibit;
His rule was so strict,
If any one kicked
He ordered her hanged on a gibbet.
—Life.

ON TOP OF CALIFORNIA.

D. M. LADD.

The sharp clanging that gradually grew into a roar loud enough to have recalled the 7 sleepers from the land of dreams, was the breakfast gong in the vigorous hands of Tim, the cook.

Jack Frost was attending strictly to business, though this was but May. The higher Sierras do not don their summer garb until much later in the year. It mattered not that the air was cold, or that the blankets seemed like an earthly paradise; for that weazened, taciturn son of the Orient was the undisputed autocrat of the camp. His motto was: "No comee, no eatee." Brief it undoubtedly was, but we found it built for business, since more than one careless fellow had gone into the hills on a frosty morning with a light stomach and a heavy heart before that epigram was recognized as law. It was at last well understood, and if any of the heavy sleepers did not put in a prompt though perhaps undignified appearance, it was a case for the doctor, the undertaker, or perchance for both. So much for discipline as administered by a Chinaman.

The moonlight still gleamed softly on the valley, making the great pines look ghostly and unreal in the uncertain changing light and shadow.

The camp was pitched deep in the valley of the middle fork, just where a little mountain brook, clear as crystal and cold as ice, came tearing down to meet the Feather, which plunged through Delaney canyon between solid walls of granite, twisting and turning like a serpent in its effort to get through the almost impassable barriers placed in its way. The boisterous little river eddied around the foot of cliffs and burrowed beneath their overhanging shadows; or rushed out into the light and went dancing and singing over boulders that its own gentle touch had worn smooth as glass; then lingered a moment in some quiet, shady pool, and again sprang forward, going onward, onward to the sea.

A few hundred feet upward, the canyon walls were bare and brown. Starting at the edge of the true wall and extending to the glittering peaks of ice 10,000 feet above the blue Pacific, was one unbroken field of snow. Was this California, "the land of flowers and eternal sunshine?" Yes, but the Sierra Nevadas are not the Santa Clara valley, nor yet the famous San Joaquin. There are numerous climates, both good and bad, in the Golden State.

Breakfast over, there followed a hasty scramble for guns, cameras and field glasses.

Just as the sun began to light up the Eastern peaks, painting the ice caps with gold and saffron, and letting soft, checkered shadows fall through the green of the pines into the valley below, the climb to the summit began. A dozen miles the way slopes upward through unbroken forests of pine and fir.

At this early hour the denizens of the deep woods were beginning to wake into life. All about, on-fallen logs and broken rock, chipmunks, small striped and insolent of manners, were making their morning meal of pine nuts. They paused with heads acock and gleaming little eyes, and viewed our progress with lively interest, or scampering for cover, stopped every few feet to sit jauntily erect, with nervous, twitching tails, to stare us in the face like animated interrogation points. Big silver-gray squirrels glided swiftly around the pines and were lost to sight in an instant. The great golden flicker and his brethren, the red-heads and sapsuckers, were waking the echoes in quest of food. Grouse were drumming everywhere on the slopes, but for this day, at least, they were to pursue their way unharmed, since our party was intent on climbing.

We passed rapidly upward until, within a mile of the summit, we began to strike the true snowcap. There progress became slower and more laborious. Nearly all the way there had been a light coating of snow but here it was of varying depth. Every few rods some careless fellow stepped where the crust was thin and went down to his armpits, scraping sundry patches of skin from shins and wrists in the descent, and making side remarks as to the utter idiocy of mountaineering.

At last, and without serious mishap, we arrived within a few hundred feet of the top. There was where the real fun of the trip began. From that point on to the very last peak there were cliffs, and they did not look as if designed for climbing, either. In fact, as an easy means of getting up in the world they were distinctly a failure. Fortunately the members of the party who were looking for ease had remained in camp, so up we went, clinging like flies to a ceiling, on those seamed and frost-riven faces. After nearly 4 hours of hard climbing we stood at last on the uppermost point of stone.

A panorama of valleys spread out before our greedy eyes. The picture was one not soon to be forgotten. We began to realize that the Sierras were 150 miles wide and

contained not one poor little range, but range after range of snowcaps, dropping away in endless procession. Gray patches of sky and banks of giant pines marked the valleys, rich with spring verdure and sparkling with many streams. These were not mere slits in the hills, but big, lusty valleys, where pine, spruce and fir, hoary with age in the days of the forty niners, were still rank with life. The sentinel peaks, rough, jagged and snowcapped, formed a contrast seldom seen in landscapes.

Several little lakes lay half hidden in the sinks between the peaks. These, as well as every running stream, were full of trout, speckled and rainbow; both with a fighting capacity when hooked that was all but marvelous.

The sweep of the eye revealed numerous little villages that to the amateur mountaineer seemed ridiculously close together, but those of us who had spent a chilly night in the open air because of this optical delusion, still held a vivid appreciation of the distances between them.

From every point of vantage we looked our fill. We loosened great boulders that went tearing downward with the noise of thunder. After lunching in the shelter of a protecting crag, we took the downward path, following in the wake of the descending sun, and just as he hid his face behind the snow crowned range, 60 miles to the Westward, we plunged swiftly down the shelving canyon wall into the valley of the shadow, where Tim and the dogs were waiting to give us a riotous welcome.

SUMMER.

WILLIAM R. BERRY.

There ain't no use a-talkin' o' the pleasures
riches bring,
Nor to spout ethereal exstasy like poet fel-
lers sing;
'Cause the novelty don't las' long when ye
get all things ye need,
An' I never yet seen poetry as could make
me change my lead.

But jus' gimme hot old summer when
there's nary thing to do,
An' the ol' crick's runnin' slow like, kinder
waitin' jus' for you;
When the tree frog in the poplar keeps a-
singin' till he's sung
That ye wish he'd git pneumonia in his
gol darn little lung.

Then fix up yer fishin' tackle an' git on
yer favorite log,
An' open up yer bait can an' git out a kick-
in' frog;
But ye soon git kinder tired while ye sit
up there an' wait,
Fer some 'vestigatin' cat fish to swim up
an' take yer bait.

So ye lay back 'ginst a tree trunk an' look
up in the sky,
An' ye wonder how that buzzard gits an-
chored there so high;
But ye soon git kinder sleepy an' begin to
doze an' nod,
While the water keeps a-tinklin' an' the
frogs croak in the bog.



AMATEUR PHOTO BY S. L. BEEGLE AND W. J. MAURER.

LIVE WILD MALE WOOD DUCK.

The camera was focused on the grass spot in the daytime and the flashlight was made at midnight.

A DAY ON LAKE OWEN.

C. C. HASKINS.

Lake Owen is between Cable and Drummond, Wisconsin, and is a signal station on the C., St. P., M. & O. railway. The lake is 2 minutes' walk from the station, and directly across it is the Eagle Knob hotel. On the beach there is always a boat, so if there happens to be no oarsman about, the way is open to do your own ferrying.

I was fortunate, for when the little craft left the shore, headed for Otter slough, Jim Stokes, landlord, companion and guide, was at the oars. It was a beautiful June morning following a protracted rain. The loons had ceased their laughing chorus, and in softer notes were congratulating each other on the fine weather. The woods were alive with songsters, each striving to outdo the others in melody. Sitting well up on a dried and barkless pine a solitary crow cawed warningly, and a panther, or some other pariah of the cat family, uttered its hateful yell, probably to frighten some timid creature into betraying itself by moving in its hiding place. A great, gaunt timber wolf set up its howl, by way of bass to the concert.

Otter slough is a long bay at the Southern extremity of the lake. Its narrow entrance, a few yards long, is shallow and clear of weeds and grass; farther into the slough the water, still shallow, widens into a bay, and is excellent ground for muskallonge, because of the weedy nature of the bottom. As we passed this ground Stokes said that by the time we had fished the bass ground there would be wind enough to ruffle the shallow water, and then we could try for a musky.

Jim had much to do between rowing and berating me in a good natured way for making an occasional foul cast. All the same, I landed bass enough that day to satisfy any but a fish hog, and we returned down the slough about noon.

Jim's prediction was correct. The wind did blow a trifle, and the musky was there. He struck, and I struck, and Jim pulled for deep water. The first move of the victim was to try to release himself by tangling up in the weeds. A taut line prevented that, and Jim pulled down through that shallow water. As the boat spun, the fish headed for the narrows. Though Jim pulled all he knew how, Musky would have beaten him but for the reel, which kept taking up the slack. He was abreast of the boat, not 10 yards away, something like a quarter of a mile, and we finally brought him aboard just at the landing.

Putting him and our bass in the ice house, we passed down the West shore of the peninsula, toward another favorite bass ground. On the way we came suddenly in sight of a loon, which set up an unusual racket, and swam near our little craft.

"Oh, ho!" said Jim, "that bird has a nest near here, and we must find it. They always nest on a bog, and I think I know just where it is."

A little searching discovered the nest, with one unhatched egg and the broken shell of the other. We heard a faint "peep, peep," and traced it to the egg. The little fellow had broken a hole in the shell about the size of one's thumb nail, and was crying lustily for release.

After satisfying our curiosity, we returned to deeper water, and there saw the mother loon, with the recently hatched baby on her back. Following her closely, she became alarmed, dropped the baby loon into the lake and swam away. It was amusing to see the little one, only a few hours old, try to dive. The head and neck would go under well enough, but despite the kicking of those funny little paddles, the body, like Banquo's ghost, would not down. When it reached the mother, the cooing of the parent reminded us of the notes of the turtle dove.

Rounding a point of land, we came silently on a redhead duck with her little family of 10, quite recently out of the shell. A signal from the mother, and they all half paddled, half flew to the shore, while she flew away. They huddled under a bush within 20 feet of us, and she flew back and forth, uttering each time she passed a word of caution. At last as she flew by them she changed her note, and the little ones, as by a single impulse, half ran, half swam, to where she settled down among them. Resting a moment, she said something more and all started for the opposite shore, the mother adopting the same speed as the young. The ducklings were only 2 or 3 days out of the shell, yet they thoroughly understood the language of their mother.

Selecting a shady, sloping bank, we pulled up the boat where the water was hardly a foot deep, and had but just stepped out of it when a school of 9 black bass came in, evidently having been driven away from the shoal by our approach.

I cast among them, but no motion did they make, except to allow the hook to be drawn past them. I tried several baits, but all to no purpose, while I had almost to fight to keep away the rock bass. The

black bass were not in the least shy, but they were not hungry, and they were not on spawning beds. I had been taking bass in another part of the lake, but utterly failed of catching these fish.

I have often found a substance like black mud in the stomach of a fish, but I never till that day saw one eating it. We

both saw a bass of possibly 1½ pounds with a lump of black muck in his mouth, close by a floating bog of that kind of mud. The fish was so near as to be plainly seen, and the lump was nearly as large as a hen's egg. I have since learned that a variety of beetle of which bass are fond lives in the floating muck.

A DISGRACE TO OREGON.

I have just obtained the enclosed photo which shows part of a catch of 400 trout made in Coos county, Oregon. I am sure you will take great pleasure in roasting these men. The 3 on the left of the picture were the boat pullers and are not re-

They salted the fish and brought them to town, for which they are commendable, as others do not even trouble to clean their catches. Such slaughter is an outrage. I hope you will skin these people as they deserve. E. B. Seabrook, Marshfield, Ore.



Dr. Byler, Mayor Bennett, Prof. Ford
Young Bennett,

Capt. Norris, Pete and Walter, boat pullers.
Young Tower.

PART OF A CATCH OF 400 TROUT IN COOS COUNTY, OREGON, JUNE, 1903.

sponsible for what occurred. The others are Professor Ford, principal of the Allegany high school of this county; Dr. Byler, a prominent physician of North Bend; J. W. Bennett, mayor of Coos; and 2 boys.

The entry in the fish hog book reads: Dr. Byler, No. 1,010; Prof. Ford, No. 1,011; J. W. Bennett, 1,012; Young Bennett, No. 1,013; Young Tower, No. 1,014.—
EDITOR.

Professor—What do you know about the ibis?

Student—The ibis is the part of the eye immediately surrounding the cuticle.—Chicago Tribune.

FROM THE GAME FIELDS.

The man who quits when he gets enough, with plenty of game still in sight, is a real sportsman.

IN OREGON MOUNTAINS.

One does not need to travel far from the railroad in Southern Oregon to reach a primeval wilderness in the pine-clad mountains lying on either side of Rogue river, 30 or 40 miles below Grant's Pass. There are found deer, black and brown bears, lynx and bob cats. It is a region where nature has lavished choicest gems of balsam-scented forests, of leaping, laughing streams, and of birds, beasts and wild things.

For the man who loves real hunting and genuine recreation, the Lower Rogue country is the place of all places, if he be willing to rough it. The hunter must content himself with a tough Indian pony, or rather 2 of them, for there must be one to ride and one to carry the pack. A mule or a burro is the best possible pack animal for the hunter in this mountain region, but they are not always easily found. The burro will never stray far from camp, will carry his load patiently and willingly, and can go anywhere a man can go except up a tree. The pack should be complete, but never made burdensome with duffle not absolutely needed. The grub kit consists, first, of a frying pan and a coffee pot. Then there is the bag of flour and the beans—always beans. Space must also be made for small cans of salt and soda. Sugar is not needed, though it may be carried, but coffee must not be overlooked. A roll of woolen blankets, a rifle, plenty of ammunition and a good ax completes the pack. In a tin box, and occupying an inside pocket of his vest, where they will always be found dry, the hunter carries his matches; and he is never without the big knife that serves more purposes than any other article of the outfit.

The hunting grounds of Southern Oregon can be reached either from Grant's Pass down Rogue river, or from West Fork, a small station on the Southern Pacific. The hunting season is August and September, and at that time the air is crisp and the sweet acorns are ripening on the ballota bushes.

After 2 days' traveling the hunter finds himself in a pine-clad solitude. As far as the eye can see are purple mountains, cut by deep canyons, down which streams go babbling to join the Rogue. The hunter must keep to the ridges, for as he proceeds deeper into the mountains all signs of the trail disappear, and he has naught to guide him but the sun or the winding river.

There is but one way to hunt in that region; that is to take a stand on an open ridge and wait patiently hour after hour. Deer will come out to feed on the rich grass, and bear will emerge to enjoy a sweet

acorn dinner. Last summer one party of 4 saw over 75 deer during their trip; bear were everywhere.

Dennis H. Stovall, Grant's Pass, Ore.

NO SUBSPECIES

I am much in sympathy with RECREATION on the question of game protection and my earnest desire that it may have even more power along that line prompts me to make a suggestion.

Commenting on the cases of Brown, McNitt and Craig, in the January issue, you call each a game hog, though the offense of the first 2 consisted in shooting in closed season, and of the other, in killing protected birds. I am not trying to defend these people. They deserve all they got. The term "game hog," as used by RECREATION, has, however, become accepted by decent sportsmen as meaning a person who takes more than his fair share of game, and in the cases mentioned it seems misapplied.

G. A. Neble, Milwaukee, Wis.

ANSWER.

I thoroughly appreciate your frank and courteous criticism, and regret I can not quite agree with you. I do not think the term game hog, or fish hog, need be confined entirely to men who kill too much game or too many fish. It seems to me a man who can not wait till the opening of the legal season to kill his game, but who sneaks out ahead of all the honest, law abiding sportsmen and kills his deer or his bag of ducks, is surely endowed with swinish proclivities. If you will pick up a dictionary you will find that many standard words in the English language have different shades and degrees of meaning. I see no reason why the term game hog should not be treated in the same way. For instance, a preacher wrote me from West Virginia that he was out hunting with several other men; that the dogs started a bear, as they supposed; that the entire party followed the dogs, but that he, being the best sprinter, outdistanced the others and got there first. The dogs treed not only one bear but 3, an old one and 2 cubs. This clergyman sailed up to the tree and killed the old bear and one of the cubs before any of the other men got within shooting distance. Naturally these other men were disgusted when they found that their pastor had knocked down most of the persimmons, and told him so. He claimed the skins of the 2 bears he had killed, but was magnanimous enough to leave the other cub to be divided between his 3 or 4 friends. He applied to me to settle the dispute, and I told him in good forcible English that I

considered him a hog; that if he had been a gentleman he would have waited when he got to the tree and found that all the bears were safely cornered, until his friends came up, and would then have offered them, or some of them, the first shot.

Do you not agree with me in this position?—EDITOR.

HOW TO COOK IN CAMP.

Wheat Bread: Put two teaspoonfuls of best baking powder and a teaspoonful of salt into a quart of flour, mixing thoroughly, first dry and then with cold water, until a thin dough is made. Put in greased dish and bake or put in tin dish, cover with another dish, put on a bed of coals, cover with coals and bake.

Pancakes: Mix the batter much thinner, but in the same proportion as the foregoing and do not knead. Add 2 tablespoonfuls of fat pork.

Oatmeal Gruel: Into one pint of boiling water stir 3 tablespoonfuls of oatmeal; salt and boil 40 minutes.

Barley Bread: Mix barley meal, salted, with warm water to the consistency of stiff dough, bake in flat cakes and eat warm with butter.

Oatmeal Bread: Make as directed for barley bread.

Oatmeal Wafers: Take a pint of oatmeal and a pint of water, add a scant teaspoonful of salt, mix, spread them on buttered pan and bake slowly.

Graham Diamonds: Pour boiling water on graham flour making a dough as thick as can be stirred with an iron spoon. Place the dough, with plenty of flour, on a moulding board and knead. Roll out half an inch-thick and cut into diamonds or any other shape. Bake in a hot oven 30 minutes. Easily digested.

Hominy: Soak one quart of ground hominy over night, put over the fire in a tin pail, set in boiling water with water enough to cover, boil gently for 5 hours, as it can not be hurried. After the grains begin to soften on no account stir it. The water put in at first ought to be enough to finish it, but if it proves too little add more carefully, as too much makes it sloppy. Salt just before taking from the fire, as too early salting makes it dark. If properly done the grains will stand out snowy and well done, but round and separate.

Lunch Rolls: Sift together one pint of flour, one teaspoonful of baking powder and half a teaspoonful of salt. Work in one teaspoonful of lard or butter and add one half pint of milk. Mix to a smooth dough, roll out to half an inch in thickness and

cut into circular shapes. Bake in a moderate oven.

Johnny Cake: Boil a pint of water sharply in a kettle, add a tablespoonful of salt and 2 of sugar. Slowly stir in corn meal till thick mush is made. After this has cooked 5 to 10 minutes put it in a greased tin dish and bake half hour over a bed of coals or in an oven.

Fried Mush: Slice cold mush thin, fry in hot butter and lard; or dip in beaten eggs, salted to taste, then in cracker crumbs and drop in hot lard like doughnuts.

Parched Rice: Put into a frying pan enough butter to cover the bottom. When it is hot add cold boiled rice, a little at a time. Fry a delicate brown and serve.

Washington Bread: Mix white corn meal with a little salt and make a batter with cold water. Spread thin on tin pans and bake well. To be eaten with butter. If white meal is not to be had use yellow. This is called pone in the South, and was used by General Washington in the field.

Recipe for tonic: 1½ ounces best red Peruvian bark, 1 ounce cloves, 1 ounce cinnamon, pulverize; add 1 quart domestic or port wine. Dose, wine glass full at meal time.

H. E. Sabine, Camas Valley, Ore.

FOUR BEAR IN A WEEK.

We had a lot of fun on our 1902 hunting trip. King, Tiedens, my brother Dick and I, with Jack, our cook and camp man, pitched camp September 1st on Huckleberry mountain.

The following day Dick plugged a 200 pound silvertip cub. Hit him 3 times out of 4 shots, running, at 200 yards.

Wednesday, the 3rd, King and I started a large black bear at long range. We fired 5 shots, 2 taking effect, as we learned afterward. We tracked him by blood drops 1½ miles to where he had wallowed in a creek. There we caught 14 trout in one sink in the stream, roasted them, ate lunch and rested 2 hours. Taking up the trail again we came, after a mile of hard tracking, to a thick windfall. The bear was just leaving it. We all sighted him at the same time, and fired. The old fellow went down bellowing, and died before we could get to him.

Thursday was wet and we did not hunt. After dinner we prospected for elk sign and saw 2 cows and a calf. The law protects all but bull elk.

Next day, while descending the mountain, I heard crackling brush and warning grunts. Soon I saw brush move and a dark object standing. I guessed at the right place and fired. With a roar a female

silvertip charged. Two .303 bullets stopped her about 40 yards from me. She weighed probably 750 pounds and was a beautiful specimen.

Luck deserted us until Monday, when King killed a black bear, making a bear apiece for the party. Tuesday Tiedens and I came in, leaving Dick and King in the mountains. They remained a week longer, moving camp to a better deer country.

Later in the month I spent a day with my friends Miller and Benze, hunting near Marion, 25 miles West of Kalispell. Of 4 deer jumped during the day we secured 3.

H. E. Houston, M. D., Kalispell, Mont.

A BOAR HUNT.

Three years ago last winter my 3 partners and I started, with 2 pack horses and a camp outfit, for a hog hunt in the foothills of the Sierra Nevada mountains. That may seem odd to those accustomed only to seeing pigs in clover or in a pen, but those who have hunted wild hogs know it is a mighty strenuous sport.

Learning that there was a bunch of hogs in a deep gulch near our camp we set out early to follow them. Wild hogs will move along while rooting about as fast as a man can travel on foot, and after finding sign it is always necessary to track them. Two of my companions went along one side of the gulch, and I the other. The fourth man made a detour, intending to strike the gulch 4 miles farther on.

Coming noiselessly to the top of a little break, I was offered the choice of 2 as fine shots as I could desire. Sixty yards up the hill stood a 5 point buck, while 200 yards down the hill a bunch of hogs was feeding. I was after hogs that trip, so I fired at the biggest, aiming at the sticking place. I shot too low, however, and the bullet, a 30-30, broke his right fore leg, and ranging back, split the toes of a hind foot.

Hearing the shot my friends across the gulch came over, bringing 2 bulldogs trained to track and hold anything alive. We set the dogs on, and the boar, after running a mile, took refuge in a thicket so dense we could not enter it save on hands and knees. With his rump to a rock the boar fought off the dogs, killing one before we came up. He charged the first man who entered the thicket, but was stopped before he could do any damage. A crippled grizzly is a tough proposition, but a wounded boar is worse, for he will fight to his last gasp.

S. V. Stevens, Lyonsville, Cal.

HOW IT LOOKS IN PENNSYLVANIA.

We had extremely cold weather last winter, the thermometer twice falling to 26 degrees below zero, and I am afraid the birds suffered greatly. Quails were plenti-

ful last fall as the result of being protected, and in the early part of the winter I saw a number of large coveys. Several farmers told me there were birds on their farms and promised to feed them during the winter. I had articles put in the papers, asking farmers to feed the quails, suggesting that they take the grain in the sheaf and hang it in low bushes and trees where the birds can easily get it. If thrown on the ground it will either be lost in the snow or blown away. There is a law in this State allowing quail to be trapped and kept during the winter and liberated on February 18. Some farmers do this, but most simply feed the quail, which become tame and stay around the premises all winter. I discovered that a number of wild turkeys had escaped the hunters in a section where these birds had become plentiful. I immediately made arrangements to have the place thoroughly patrolled and made many trips myself along that part of the mountain, with the result that the turkeys were not molested. There are several hunters living in that region who would have killed them if given a chance. One man said to a friend that he was afraid to stick his nose out of the door with a gun in his hand.

Harry P. Hays, Hollidaysburg, Pa.

The game law of New York should be amended to prevent the slaughter of deer in September. Nine-tenths of the deer killed in that month are gotten by floating, and $\frac{3}{4}$ of them are does and fawns. Some sportsmen would prefer to shorten the season by cutting out the last 2 weeks. That would not materially reduce the slaughter, as but few deer are killed by still hunting in November.

T. J. Fenton, Jamestown, N. Y.

We have a few rabbits, squirrels and grouse. A little farther North are deer; few were killed last season, though the woods were full of hunters.

F. Goodfruit, Ada, Mich.

Most game is scarce here, but a few quails, rabbits and ruffed grouse can be had.

Raymond Hagar, Traverse City, Mich.

Mrs. Collier Down—How did it happen that when we came home from the theatre last night I saw you let a policeman out of the basement door?

Mary Ann—Oi don't know, mum, unless th' play was shorter than usual, mum.

Join the L. A. S. and help protect the game. ,



I have just shipped you a Slipp-Slap pup. Leave the old dog home and take this one out

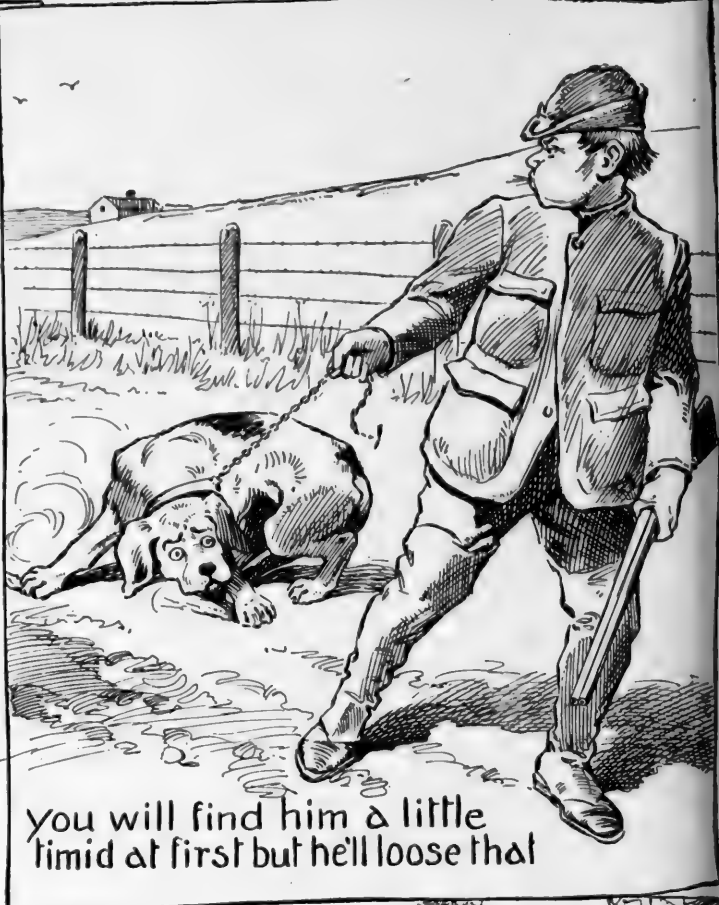

you will find him a little timid at first but he'll loose that



You will find that he outranges any dog you ever saw

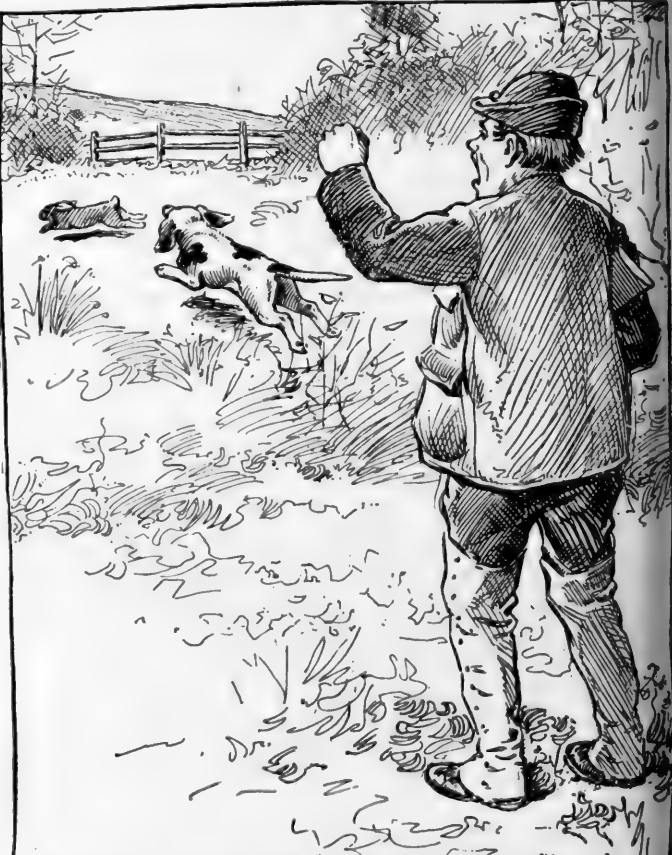

In fact that he is the speediest dog ever taken into the field.



One thing that will attract your attention is his quick stops on points



Also his high headiness and the way he carries his nose



In shooting you will have no trouble as he finds every bird



His Pedigree
Shapeless

{ Dam....ned.....by...everybody
{ De....Sire....d....by....nobody

FISH AND FISHING.

ALMANAC FOR SALT WATER FISHERMEN.

The following will be found accurate and valuable for the vicinity of New York City:

Kingfish—Barb, Sea-Mink, Whiting. June to September. Haunts: The surf and deep channels of strong tide streams. Baits: Blood worms, shedder crabs and beach crustaceans. Time and tide: Flood, early morning.

Plaice—Fluke, Turbot, Flounder. May 15 to November 30. Haunts: The surf, mouth of tidal streams. Baits: Shedder crabs, killi-fish, sand laut. Time and tide: Ebb, daytime exclusively.

Spanish mackerel—Haunts: The open sea, July to September. Baits: Menhaden, trolling—metal and cedar squids.

Striped Bass—Rock Fish, Green Head. April to November. Haunts: The surf, bays, estuaries and tidal streams. Baits: Blood worms, shedder crabs, Calico crabs, small eels, menhaden. Time and tide. Night, half flood to flood, to half ebb.

The Drums, Red and Black. June to November. Haunts: The surf and mouths of large bays. Bait: Skinner crab. Time and tide: Day, flood.

Blackfish—Tautog, April to November. Haunts: Surf, vicinity of piling and old wrecks in bays. Baits: Sand worm, blood worm, shedder crabs, clams. Time and tide: Daytime, flood.

Lafayette—Spot, Goody, Cape May Goody. August to October. Haunts: Channels of tidal streams. Baits: Shedder crabs, sand worms, clams. Time and Tide: Day and night flood.

Croker—July to October. Haunts: Deep channels of bays. Baits: Shedder crabs, mussels. Time and tide: Day, flood.

Snapper—Young of Blue Fish. August to November. Haunts: Fivers and all tide ways. Baits: Spearing and menhaden; trolling pearl squid. Time and tide: Day, all tides.

Sheepshead—June to October. Haunts: Surf and bays, vicinity of old wrecks. Baits: Clams, mussels, shedder crabs. Time and tide: Day, flood only.

New England Whiting—Winter Weak-fish, Frost-fish. November to May. Haunts: The surf. Baits: Sand laut, spearing. Time and tide: Night, flood.

Hake—Ling. October to June. Haunts: Open sea surf, large bays. Baits: Clams, mussels, fish. Time and tide: Day and night, flood.

Weak-fish—Squeteague, Squit. June to October. Haunts: Surf, all tideways. Baits: Shedder crabs, surf mullet, menhaden, ledge mussels, sand laut, shrimp. Time and tide: Day and night, flood preferred.

Blue Fish—Horse Mackerel. June to November 1st. Haunts: Surf, open sea and large bays. Baits: Menhaden, surf mullet and trolling squid. Time and tide: Daytime; not affected by tides.

IDENTIFIED.

W. K. M.

A group of men, all disciples of Walton, sat about a camp fire in the Adirondacks. The guide, after the manner of guides, was explaining just how and why they had not caught many fish. For several days he had been saying, "Jest wait till in the morning; then we will ketch all the trout you can carry."

It happened that an attorney and an editor were in the party and when the guide had finished his marvelous tales of "what we done when I was a boy," the attorney winked at the editor and told the following:

"When I was a young lad I went to Ampersand pond, famous for its trout. After several days of successful sport my friends broke camp and started for home. As we pulled across the lake I could not resist the temptation of a final cast. Immediately a fish struck my fly and I reeled in a small but beautifully marked trout. It seemed a pity to retain so small a fish when we had all the law permitted us to take. Moreover, the little fellow had the brightest spots I ever saw on any fish; so I returned him to the water, but not until I had cut a small notch in his dorsal fin. I cut it deep and knew that if he grew to goodly proportions the mark would become very distinct.

"Five years afterward several of us visited Ampersand. We again had good luck. On the morning of the last day I cast far ahead and drew the flies along a submerged log. There was a tremendous splash, and the line cut about at a great rate. When I finally got my captive to the boat my guide deftly netted and brought in a 5 pound trout. As it lay gasping on the bottom of our boat I plainly saw the mark in its fin. It was the same fish I had caught years before."

The editor laid aside his pipe, and with a deprecatory glance around the circle, he said:

"When I was a cub reporter on one of the big dailies I worked so hard that I became threatened with consumption; so they sent me to the mountains to rest. I had made several good scoops for them, and it was no more than right that they pay for my vacation. Ampersand was too far in for me to stand the trail, so I put up with my guide in a comfortable cabin on Colby pond, nearer civilization.

"We fished most of the time. On the last day of my stay I, too, thought to have one more cast and, like my distinguished friend, I hooked a small fish. It was not so beautifully marked as his, but it was below the legal length and I decided to return it after having properly marked the foolish fellow. Turning it over I saw the fins were too small to cut, that no marks could be made on the head, and that there seemed no way by which it could be subsequently identified. If I could but attach some small object to its tail that would serve the purpose. I ran my hand in all my pockets and found a little nickle whistle. With a bit of thin wire I fastened the whistle to the trout's tail, making the perforation in the thickest cartilage so no injury might come to the fish. Then I put it back.

"Five years afterward I visited Colby

pond. The same guide took me over to our old cabin. We again fished and caught some good strings. One afternoon I hooked an apparently large fellow while bait fishing in deep water. He came up slowly—appeared to be logy and did not run—or fight; but he strained my tackle. Just as he came to the surface and the guide, after a mighty effort landed him safe in the boat, I discovered I had taken the same fish, the one marked years ago.”

We observed silence, but the guide put in anxiously,

“Had he grown much?”

“He had not changed a particle, but the whistle had grown into a foghorn.”

The guide busied himself about our balsam beds at once, nor did he offer any more stories of immense trout.

“The press is mightier than the law,” remarked the attorney dryly.

HE GOT WHAT WAS COMING TO HIM.

L. F.

I never was what might be termed a successful angler, though from an early age I was a lover of the gentle art and could patiently wait hours for a nibble. I do not remember to have caught more than 10 fish in one day; frequently I caught none at all. Once I landed 3 trout in 5 minutes and another time I caught a 28-pound pike, which I spent hours landing. On the whole, I always returned satisfied from a day's fishing.

Among my chums in those days was a boy who, up to the time I speak of, was fond of fishing. However, he thought it slow work with rod and line and with the help of another chum of ours invented a way to kill fish with dynamite. His father's farm bordered on a lake literally full of pike and perch. A quarryman showed him how to put the detonator containing the fuse into the stick of dynamite and common sense taught him how to sink it. He made 2 experiments which proved successful.

He was preparing to make a big haul and had baited part of the lake to attract the fish. Another friend and I were to be present to see the sport and help collect the fish. I was much disappointed when pressing business kept me away.

My friend had to go on with the slaughter alone as our chum did not turn up either. About 3 p. m. on a July day he rowed out to the part of the lake he had baited. For some reason he had to strike nearly a box of matches before one would burn sufficiently to light the fuse. At last he got it lighted and threw it in the proper place, which he had marked with a floating cork.

It was then time for him to row for his life. He grabbed for the oars, but to his horror saw one of them floating 10 yards

from him, it having slipped out while he was lighting the fuse. He rowed frantically with the other, but instead of getting away from danger was right on top when the explosion came. He and the boat were blown 30 feet upward. When he came to himself he was on the keel of the boat, which was floating bottom up near the middle of the lake. He could not move lest he tumble off, nor could he swim ashore with his clothes and shoes on, being at best a poor swimmer. As it was a calm day there was no hope of his drifting ashore. He cried for help and at last some one heard him. It took some time to decide how to rescue him, there being no other boat on the lake. A boat was sent for, but before it arrived my friend had been 3 hours in the water, and from fright and exposure was well nigh exhausted.

When our chum who had arrived meantime, saw him safely landed, he collected the fish. They were of all sizes, from the smallest perch up to a pike 5 pounds in weight. As it turned out, it did the fish a good turn, for had he taken the 480 fish he killed without an accident he and his 2 chums might have become a trio of fish hogs, the like of which the world never saw.

We were scarcely to blame, as we were but boys, and did not know we were breaking both the laws of the land and the laws of common decency by our act. However, it was all for the best, for it left us thankful thereafter for small mercies in the fishing line. One of the trio has since fished in the rivers of California, but not as a fish hog.

A DISAPPOINTMENT.

Dick Kirkham was coming down the Mapee, attired in a wading suit which “Old Hossfly” Jim Bryant had picked up for him in the lumber town of Pelton. About the time he reached the pool at the turn of the river I yelled for him to hurry and help me land the biggest trout in Michigan. I had put a red worm down the current into a big pool that churned and foamed beneath the overhanging branches of a giant elm, and got a bite that almost pulled me in over my boot tops. When I struck, it was simply a question of tackle endurance, but as I was equipped with an Alta line and a No. 4 Pennell on a double gut leader I had no fear of the fish breaking away. But just beneath the surface of the foamy water a forked snag afforded the fish a splendid opportunity to hang me up. He took advantage of it so thoroughly that the only direction he could take the line, after he had fastened it between the forks, led over to a pile of drift and brush, which meant freedom for him and confusion to me if he succeeded in reaching it.

Before I put this particular worm into the pool I remembered how Old Hossfly had wiped my eye 3 years before with a 2 pounder which he had taken out of this same water. As I held the fish against the snag and felt his mighty struggles I saw myself exhibiting a monster trout to the admiring eyes of the aforesaid Hossfly.

That heavy wading suit impeded the rapidity of Dick's movements, and as he didn't come quick enough to suit me, I gingerly felt my way in on tip toe, with the water about to overwhelm my boot tops. By that time I had worked the fish up in the crotch of the snag and could faintly discern the dim outlines of my captive. The sight proved too much for my caution and in I went up to the waist until I could reach down and grab him. The fish was helpless against the crotch and as I reached for him, my hand came in contact not with the slippery, velvety skin of a trout, but against the spikes of the dorsal fin of a wall-eyed pike. As I released the fish and struggled to shore with him, Kirkham came along and admired my catch, but I could see the sly gleam of fun in his eye as he passed on down the stream.

The pike weighed $5\frac{1}{2}$ pounds, was built like a race horse, and in a clean stretch of the stream it would have been a pleasure to play him with light tackle.

It will be many a long day before I forget the thrill which made me warm with hope when that pike took my hook in the finest trout pool in the beautiful Maple.

James D. Ernston, Anderson, Ind.

THE WAY OF IT.

Just over the Southern line of New York, where the mountains crowd each other so closely that the beautiful Chemung is forced to share its fortunes with the more majestic Susquehanna, lies a natural park, Tioga Point, unknown to the many, though famous for its wealth of Indian lore.

There, where the rivers meet, is formed a large and beautiful body of water of considerable depth. Many a fine string of black bass have I taken from its rocky depths; and though I have taken them from lakes and streams in many other places, nowhere have I found the bass more gamy or more ready with that gallant rush and plunge we know so well.

Still lingers the memory of my first experience when, as a small boy with an indulgent father, I was allowed to join in an early morning trip. My father and his friend had fairly good luck, but the fish were not large and therefore not satisfactory to either angler. Try as patiently as they would, no big fellows could be lured to the gaff.

Being the smallest and least important member of the party, I must needs content

myself by baiting with the lowly worm, which proved to have less drawing power than the lively minnows the men were using. Becoming convinced at last that I was being discriminated against in the matter of bait, I brought such pressure to bear that Father grudgingly fished from the pail a dead minnow and gave it to me.

My minnow was dropped quietly over the side of the boat and we were doing business once more.

For some time blue smoke curled quietly from 2 aged pipes and things were growing monotonous.

Suddenly there was a disturbance in one end of the boat, and Father turned to see a struggling boy, too wildly excited for articulate speech, grasping the end of his old maple pole as if he feared it would get away, and frantically motioning for help. Between all hands the fish was landed, and a choice one he proved; the largest taken that day, on a measly little dead minnow, and by a small boy, who felt fully the importance of the event.

Ben W. Stroud, Cleveland, Ohio.

I am a regular subscriber to your valuable magazine, and fully conversant with the stand you take against the bristlebacks. I most heartily commend you. Every true sportsman should give you the benefit of his observations, to enable you to keep up your good work. I enclose a clipping for you to load your gun with, and fire into the ranks of our enemies.

Thos. E. Lewis, Norfolk, Va.

C. C. Cobb and J. B. McGraw exhibited in their office yesterday morning 50 large bass, weighing 2 to 5 pounds each and more than 30 pike and other fish. The time occupied in making the catch was only one hour and 50 minutes. They used an ordinary pole and line, with live bait.—Virginia Pilot.

I wrote these men as follows:

I am informed you and a friend recently caught 50 large bass and more than 30 pike in one day. Will you kindly tell me if this report is true?

I received this reply:

Mr. Cobb and I caught 50 bass, or chub, as we call them down here, and 25 pickerel at Lake Smith, about 6 miles from Norfolk, October 14th, in an hour and 50 minutes.

According to the rules of the Water Department, who have charge of the fishing privileges of the lakes, each angler is limited to 25 chub, and as 50 made the limit for both of us, we had to leave when they were biting about as lively as I have ever seen fish take the line.

James B. McCaw, Norfolk, Va.

Assuming that the 50 bass and the 25

pickerel averaged 2 pounds each, these men took 150 pounds of fish in one hour and 50 minutes. Gee whiz! How they must have sweat and puffed and yanked to have pulled so many fish out of the water in that length of time. In order to take 75 fish in 110 minutes, deducting the necessary time for detaching the hook from each and rebaiting and recasting, they could not have allowed any of the fish to run 10 feet after being hooked. The only sport these rooters could possibly have had must have been the mere slaughtering of fish. It must simply have been a case of hooking and yanking; but that is what the average bristleback considers real sport.—EDITOR.

WINTER FISHING.

I had a day's fishing on Bashan lake last Thanksgiving. We started early in the morning and after a 10 mile drive in the piercing cold we arrived at the lake. We set out about 36 tips, getting them all in by 8 a. m. They gave us all the employment we wanted. We would no sooner catch hold of the spud than a flag would go up. We had 13 good pickerel before we had our tips all in, and after that it was all we could do to handle them.

We caught before 3 p. m. 178 of the finest pickerel we ever saw and 191 perch. Then our bait gave out, so we returned home. On arriving there we displayed our catch and weighed them on a Fairbanks' scale. They footed up to exactly 513 pounds. We consider this exceptionally good luck at that early season.

W. G. Reade, A. H. Baird, Middletown, Conn.

Some readers may wonder why I do not rebuke these men. The reason is that I do not regard pickerel and perch as game fishes, and should be glad to see them all cleaned out of waters inhabited by better fishes.—EDITOR.

NIBBLES.

My home is in Ellisburg, Jefferson county, N. Y. A club there of which I am a member controls 1,800 acres of duck and pickerel marshes. Mr. F. Galliger has as much more land adjoining ours, and has established a summer resort with all equipments. The North branch of Big Sandy runs through his territory and affords excellent black bass and pickerel fishing. To the South lie 10 miles of marshes and ponds. We leased our land to prevent non-residents from securing it, and in order that all our home people might have a place to hunt and fish. We bar none from our land, but outsiders who shoot or fish on it are required to pay \$1 a day toward its maintenance.

Before leaving home last spring, I helped plant 10,000 brook trout in our waters. We now have 3 trout brooks stocked with 35,000 fish.

C. H. Noble, Ellisburg, N. Y.

September was a banner month for anglers on the Madison lakes. More large pickerel were caught than during any other month of the season. Robert Keyes landed one which measured 3 feet 8 inches and weighed over 20 pounds. Chas. Bryant caught a 12-pounder after a vigorous tussle. Both were taken from Lake Mendota. Andrew Hippemeyer in one day caught 2 pickerel weighing 11 and 13 pounds respectively. A few days previous he captured a black bass weighing 5 pounds and 14 ounces. They were caught in Lake Monona. Many more large fish were caught in both lakes while medium sized white bass, yellow bass and pickerel were taken in abundance.

Leo Bird, Madison, Wis.

734,544. Trimming for Fishing Rods. James B. Hall, Cleveland, Ohio. Filed July 22, 1902. Serial No. 116,503.

Claim.—1. A band for a fishing rod, formed of bendable metal and having on its inner face an integral rod-engaging means curved inwardly from opposite sides, as set forth.

2. A band for a fishing rod, formed of

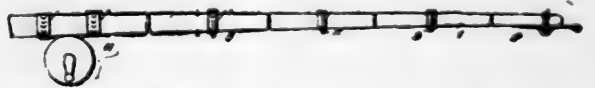

bendable metal and provided with integral spurs curved inwardly from opposite sides to embed themselves in the rod.

Tony Huss and I boarded the A. & S. C. train for Knappa, one day last summer, to take a shy at the trout. Arriving at that station at 9.30 we walked out to the farm of W. H. Twilight where we stopped for lunch. About 10 o'clock we went to the river and commenced fishing. In the course of the afternoon I caught 4 good sized salmon trout, and Mr. Huss caught 8. He got one steelhead salmon 33 inches long. It weighed 12¼ pounds. This made all the fish we needed, and having had fun enough to last us a long time, we returned to the city on the evening train.

D. R. Blount, Astoria, Ore.

A remarkable duck story comes from Nantes, France. Some fishermen were out at sea during a terrible thunderstorm, when suddenly a number of roasted ducks fell into their boat. The lightning had struck a flock and cooked the birds to a turn.—Argonaut.

GUNS AND AMMUNITION.

Anybody can shoot all day, but a gentleman always quits when he gets enough.

ROBIN HOOD POWDER.

Last October my attention was directed, by an ad in RECREATION, to Robin Hood powder. I sent to the factory for a sample, and proceeded to make a thorough test of it, both at the trap and in the field.

After trying several kinds of shells, I found that the Blue Rival was admirably adapted to this powder. I loaded a number of these shells with $3\frac{1}{4}$ drams of Robin Hood; one card and 2 black edge wads over powder; $1\frac{1}{8}$ ounces No. 6 chilled shot; one light card wad over shot; and with $\frac{1}{4}$ inch crimp. I used them in duck shooting, both at mallards and widgeons, and I found I could do better work than I had formerly done with larger shot over the same range. The pattern and the penetration was all that could be desired.

I have used 3 drams of Robin Hood and $1\frac{1}{8}$ ounces No. 7 $\frac{1}{2}$ chilled shot, at the trap, with excellent results. Those who desire a powder that will give great penetration and a close, regular pattern, cannot do better than to use Robin Hood.

L. L. Burtenshaw, Council, Ida.

What is the difference between dense and bulk powders? How is pressure determined on gun wads? What is the composition of black powder?

John Daniel, Eufaula, Ala.

ANSWER.

A dense powder, so called, is of the smokeless variety and so compounded that the quantity required to give a certain effect is much less in bulk than other powders not of this character. All dense powders being of small bulk, should be weighed and not measured by volume. The so-called bulk powders are also smokeless, and have their strength so proportioned that bulk for bulk with black powder, they will produce results approximately the same.

Pressure on gun wads is determined in various ways. In hand loading it is ascertained by using a special spring rammer. The spring, when compressed as far as it will go, indicates a certain predetermined number of pounds. By applying the rammer each time until the spring is fully compressed, a degree of accuracy in pressure is attained.

Black powder is composed of varying proportions of potassium nitrate, sulphur and charcoal. Black powder has been made employing other chemicals, but the ingredients named have, however, been almost universally employed in compounding a stable black powder.

An ordinary sporting powder would have the ingredients mixed in about the following proportions: Potassium nitrate, 78 parts; sulphur, 10 parts; charcoal, 12 parts.
E. B. Guile.

THE REPEATER MUST GO.

I am with you heart and soul in trying to prevent the use of the game hogs' weapon—the repeating shot gun. It is a game destroyer in the hands of a good shot, a great consumer of ammunition in the hands of a poor shot, and the tool with which thousands upon thousands of waterfowl are each year bagged by market hunters.

Most people who buy these guns do so because they can fire more shots in a given space of time, and consequently kill more birds.

Hundreds of wealthy men use them for this very thing. Go to Detroit and see how it is there. Paul Bagley and Owen Scotten are 2 examples. They feel bad if they can't put 6 shots into a flock of ducks. Scotten will empty his repeater at a flock 100 yards distant, yet he owns a \$1,000 Greener and a \$750 American gun.

The Winchester Repeating Arms Co. used to advertise "6 shots shot in 3 seconds," and "if you had a repeater you might have killed 6 birds instead of one or 2." Four or 5 years ago they got down to "A third shot to kill a cripple," when sentiment against the use of repeating guns began to show. Now they claim to be friends of the game and of game laws and are advocating a limit on the bag of so many birds a day. That sounds nice, but what does it amount to? Nothing; because if the limit were 25 ducks per day, the man that wanted to kill 100 would find people enough, whether guides, boat pushers, or what, that would gladly kill 25 ducks for a dollar and not fire a shot.

The deer limit in Michigan is 3 to each license, but there are plenty of licenses issued to people who do not fire a shot nor even try, yet somebody does the killing.

The Winchester people have a lot of money and are going to make a fight to prevent legislation antagonistic to their interests.

If we succeed in stopping the use of repeating shot guns, it need cause no loss to the country lad who worked hard to save the \$17 he paid for his repeater. The magazine on every repeater can be easily and permanently blocked so that it will contain but a single cartridge, and at a cost of not more than 50 cents. A nice little fine of \$100 for anyone found using a repeater

in which the magazine was not blocked would be an inducement toward spending the 50 cents.

The repeater must go. Push the good work along.

C. L. V., Kalamazoo, Mich.

GET NEW BARRELS.

I have an old 12 gauge Parker hammer gun. It is in good condition save that both barrels are pitted. The bore is unusually large for a 12 gauge, so large that a No. 12 will almost fall through. I did pretty well with it last fall while grouse shooting, but got most of my birds within 20 yards. At a greater distance it scatters badly. Would 11 gauge wads improve its shooting? Would it be advisable to use smokeless powder in this gun?

Charles Gun Crank, Phila., Pa.

ANSWER.

About 15 years ago Parker Brothers made and put out some guns chambered and bored to use either brass or paper shells, and, of course, black powder. The best results were obtained in those days by making a so-called 12 gauge gun with a slightly larger bore than had previously been used and than is used now in that grade. Many shooters used in such guns No. 9 wads, and some of them used No. 10, but it was invariably found necessary to use as large as No. 10 wads in order to get the best results.

Since the introduction of smokeless powder and the practical abandonment of brass shells, 12 gauge guns are bored so that they measure exactly what they purport to be, and it is not necessary to use in them such large wads as were formerly used in order to get the best results with modern loads.

Furthermore, it is likely that your gun has worn out to some extent, and that the openings in the barrels are larger now than when the gun was made. A barrel that is pitted will never do as good shooting as one that is in perfect condition.

The only remedy, therefore, is to get a new pair of barrels made.

I would not advise you to use smokeless powder in the barrels you now have. That would be a dangerous experiment.—EDITOR.

HIS CHOICE.

I note in March RECREATION that a reader asks which is the better to take into the Maine woods, a 32 Winchester Special or a 38-55, to which I say, by all means take the 38-55, which will be more popular in the near future than ever before. I am not using this caliber myself, but, if I were to choose between the 2 mentioned, I should certainly buy the 38-55 for hunting purposes. I have a Savage 32-40 which is as strong a shooting gun as the 32 Winchester

Special, and a 38-55 is certainly stronger than either, whether it be Winchester or Savage. I consider the 32-40 large enough for anything that walks in America; if I did not, I should have a larger caliber rifle. I also have a 25-35 Savage rifle, with 22-inch barrel, which is the strongest shooting gun of its size and the most accurate I have ever used, considering the charge and caliber.

I reload the 32-40, using as a high pressure load 25 grains of 30 caliber Dupont smokeless or 24 grains Laflin & Rand Lightning, with metal patched bullet. For medium load I use 18½ grains Dupont No. 1, with bullet cast in cylindrical Ideal mould No. 31954, paper patched. In patching the smooth bullets, I use enough paper to project over the base, so that the bullet can not touch the smokeless powder. The weights of powder I have given are by scales. I use an Ideal measure or loader, but the scale on the loader will not prove correct on all powders by weight. To get the 25 grain load of Dupont 30 caliber smokeless, I set the loader at 27 grains. The loader set at 40 grains on No. 1 Dupont will give 18½, and for the regular 17 grain load, as recommended, the loader should be set at 37 grains. I use both U. M. C. and Winchester shells, but the U. M. C. work better in the Savage gun. There is a slight difference in these shells as to muzzle and base measurements. I have calipered them both before they had been shot, and I find one larger at the base and smaller at the muzzle than the other. I also have to keep on hand 2 different sizes of primers, as the U. M. C. requires a smaller primer than the Winchester. I use black powder primers with black powder loads, which give the shells more durability than if smokeless primers were used.

There is much more recoil from the medium black powder charge than from a charge of high pressure smokeless used in the same rifle.

I take great pleasure in reading RECREATION. In fact, I have recommended your publication to a maker of hunting boots as an advertising medium, and would do the same to others should they ask my opinion in regard to such a matter.

J. W. Smith, Bonner, Mont.

THEY ROAST THE AUTOMATIC GUN.

After trying a 45-70, a 45-90 and a 50 caliber, all Winchesters, I am now using a 30-40 of the same make. It has been my good fortune, during trips in the Maine woods to kill moose, deer, caribou and black bear. For such game give me a 30-40 every time. The gun is not only light, which means a great deal when one is alone on a long carry, but is also more powerful than the other calibers I have mentioned. I shot

with it a moose and a caribou at between 200 and 250 yards. Each dropped where it stood, with both shoulders broken. When using a 45-90 I never succeeded in putting a bullet clear through even a deer. An animal might escape with one shoulder broken, but never with both shattered.

In regard to the automatic shot gun, I think the putting forth of such a weapon would be calamitous alike to sportsmen, gun makers and to the game. Its sale would be limited to market hunters and hogs, while its disproportionate destructiveness would lessen the demand for other guns by lessening opportunity for their use.

A. H. Gilbert, Philadelphia, Pa.

As a lover of the birds and the wild animals, I protest against the making and selling of an automatic gun. Neither I nor any member of my family will ever buy or use an automatic gun, and we will discourage its use by others in every legitimate way. We will not associate with any man who may use such a weapon.

Aurelia Hall Bonney, Hanover, Mass.
President of the Hanover Band of Mercy,
Director of the Rockland Humane Society,
Local Secretary of the Massachusetts Audubon Society.

I have been reading RECREATION for years, and think it is the best magazine for true sportsmen. I strongly endorse your protest against the automatic gun. It is a shame that these guns have been invented; in a few years the game will be exterminated if the use of these abominable weapons be permitted.

John D. Wing, Millbrook, N. Y.

Keep up the good work against the automatic gun. Every true sportsman in the country is with you, as well as every one else who doesn't want to see the wild creatures of the woods exterminated. I will do all I can to discourage the use of both automatic and repeating shot guns.

H. C. Wilcox, Bennington, N. H.

I heartily endorse your crusade against automatic and pump guns, and trust you may be successful in securing the passage of laws in all the States to prohibit the use of these weapons. Of course, decent sportsmen will never use them, and the other fellows should be restrained from using them.

Will Thomson, Independence, Kan.

We expect to make the manufacturers of pump and automatic guns stick their fingers in their ears when they hear the roar of New Jersey's non-destructionists.

Edward F. Duffy, Newark, N. J.

The Winchester people will make a great mistake if they put an automatic gun on the market. I like the way you roast the game hogs.

P. O. Badger, Augusta, Me.

Your bill to prohibit the use of repeating shot guns received. I will do all I can to get this bill enacted into law.

W. B. Ivey, Jacksonville, Fla.

SMALL SHOT.

Until last fall I used a 12 gauge, 30 inch Ithaca, weighing 7 pounds, 9 ounces. While it was satisfactory in every way, I fancied that a lighter gun and its relatively lighter ammunition would suit me better. Accordingly, I ordered a 16 gauge, 28 inch, 7 pound gun of the same make. It was built exactly as ordered, save that it weighed only 6 pounds, 11 ounces. It gave good penetration, but the pattern was poor and the recoil, even when I used a shoulder pad, was unbearable. I tried it with Winchester, U. M. C. and other factory loaded shells, always with the same result. Is the trouble due to some defect in the gun, or to the fact that standard 16 gauge factory loads are too heavy for this particular weapon? Not loading my own shells, I have not tried it with lighter charges.

C. E. Baird, Albia, Ia.

We have been hunting ducks and other game most of the winter. We killed 537 mallards in February, 173 of these on one trip; and 58 birds were killed at 5 shots with a Winchester pump gun. My partner, Mr. Boval, sneaked up to a small pond and killed 84 ducks with 6 successive shots of a pump gun in as many seconds. This sounds marvelous, but it is true.

T. J. Dunn, Pawhuska, O. T.

Yet some people claim it's all due the man behind the gun! Does any sane person imagine that these brutes could have committed such slaughter with double barrel guns? Such talk is simply ridiculous.

—EDITOR.

I have an old Colt's army revolver, cap and ball, caliber 36, 7½-inch barrel. It is in excellent condition and I am told it is an accurate shooter. What is the best way to load such a revolver, and will a round or conical bullet give best result at the target? I should greatly appreciate information regarding the charging, holding, use and care of this weapon.

W. O. Brown, Youngstown, O.

I have a new 22 Savage rifle and consider it the best gun of that caliber for target purposes and small game hunting. I like the way you pen the game hogs; they need it.

Lester R. Watts, Kensington, Kans.

NATURAL HISTORY.

When a bird or a wild animal is killed, that is the end of it. If photographed, it may still live and its educational and scientific value is multiplied indefinitely.

AS IN OLDEN TIMES.

Some of your items in RECREATION about the slaughter of wild ducks remind me of old times. I formerly lived on Lake Huron at the Northern shore of Saginaw bay, and the fishermen there killed vast numbers of wild ducks and gulls. Some of the ducks were good to eat, but all had good feathers and all ate fish. I have seen tons of wild game birds lying dead and their feathers sold on the spot for \$1 a pound. Some of the plumage was exceedingly beautiful. Many of the skins were taken off and sold with the heads and wings for millinery purposes. Many of the birds were sent to market and some of the uneatable ones were used as fish bait. Some of the birds were, of course, wasted, but the fishermen thought it was all right to destroy them, as the gulls and ducks ate the young fish and made business less in prospect for the fishermen. Now the fishermen and fish, the gulls and ducks, are all alike departed, and the shores know them no more. Most people think the lumber business was the cause of the fish leaving the shore, as the refuse from the mills fouled the waters. With the fish went the gulls and ducks that fed on them, and the fishermen turned to other ways of making a living or followed the fish to other shores. Now the pines are gone and the lumber men.

I wish the shores might be given up to forestry. Then the wild things would come back and the waste places would be glad again. I often recall those times and scenes and sigh over the wastefulness of mankind! When I lived there deer often came out to drink or swim, and when pressed by the hounds they would swim from one point to another, five miles in a straight course. One Sunday morning a large stag came on shore in our door yard and he was so exhausted he lay perfectly still several hours before he was able to go into the woods. We went up to him and put our hands on him. He had beautiful horns.

At another time a half grown fawn came in and my brothers secured him. They built a stockade and kept him a year and a half. He grew, and became quite tame. We fed him all the grass, hay and vegetables he would eat, and it was in that way he met his death, for a small potato rolled into his windpipe. My brothers tried to help him but it was impossible to get out the obstruction and Dexter died. My

brothers had named him for Robert Bonner's celebrated trotter, then first introduced, so by that you can tell how long ago it was.

One night in summer we all sat at the supper table and saw 5 deer go by our door yard fence on the way to the water. It was in the season when they had no horns. The big male was first; after him were 2 does, 2 fawns and a yearling. They went down to the water, got their drink and went back to the woods, melting into the shadows without a sound. I shall never forget how still they were; like shadows.

One night I sat at the chamber window enjoying the moonlight and saw a big buck on the sand. I did not see him come; all at once he stood there. He had a magnificent set of antlers. Soon does and fawns stole out of the underwood and slipped one after another into the water; I counted 9 of all sizes. The old buck stood sentinel till all had drunk and washed. When they had stolen away into the dark he went like a shadow and drank and bathed. Then he, too, vanished like a dream. I despair of giving any idea of how charming and mysterious it was; but it is a picture on memory's wall and I enjoy it as I would a choice painting.

I know you are in sympathy with all this, for your editorial work shows one in tune with nature in her wild and unspoiled aspects.

Mrs. H. P. Piper, Lapeer, Mich.

A NEIGHBORLY SKUNK.

It was August. George and I had pitched our tent, cooked and eaten supper, made our beds and at 9 p. m. we turned in. On opening my eyes in the morning I found, about 4 inches from me, a skunk. When he saw I was awake, he turned and scampered out. We found our pork scattered all over the ground. The skunks had sampled every piece of it and rolled it in the dirt for luck.

Our tent was too small for comfort, so we decided to build a shanty. Three days later we had it up. The floor was earth and the door was missing. We built 2 bunks, the bottom one about 6 inches from the ground. The first night passed quietly, but the second night about 12 o'clock George wakened me. Something was making a racket near the stove. We got up, George lighted a piece of paper, and we looked around for the intruder. We found Mr.

Skunk trying to eat one of our seats. For the next 20 minutes George kept the light burning, while I tried to make the skunk understand that he was not wanted. I got him up to the door a dozen times, and just as we thought we had him out he would bolt to the back of the shanty. I would have kicked him out, but for obvious reasons I did not. At last he went out and we went to bed. The next day we put the door on, so that our callers would have to knock before getting in.

About a week later, while sleeping in the lower bunk, I was awakened one rainy night by something heavy on my chest. It was too dark to see anything, but I put out my hand and down it came on a skunk. He ran off, and I could feel his bushy, wet tail slip through my fingers. I got up and slept with George the rest of that night. In the morning we found where the skunk had dug under the bottom log of the shanty. We had no more trouble with them after that.

They were not at all afraid of us, and ate everything we threw out.

If one happened to be in the path when we went after water he would not hurry to get out of the way and of course we would not hurry him. If a skunk is treated right he will act right. I knew 2 fellows who were trying to kill a skunk with clubs. One of them made a lunge at the skunk and the club broke and he fell almost on the skunk. He got a good dose, full in the face. I never heard of his trying to kill another skunk. His intended victim got away.

J. J. McCormick, Ann Arbor, Mich.

A SEVERE INDICTMENT OF THE CROW.

Many people are wondering what has become of the song birds. They have been growing scarce for a long time. I know how they are going here in Massachusetts, and it is so all through the other States.

In June and July of every year, when the young birds hatch, I have watched crows eat them. The crows begin about 4 o'clock in the morning, or a little later, and they look the shade trees over for young birds. They go into the trees that stand in yards and that line the streets near buildings. As soon as people stir from their houses the crows disappear for the day, but begin again the next morning just the same and they eat every young bird they can find. The robin will put up a good fight with them, but the crows will get the young birds in spite of the parents. Every kind of small bird that builds its nest in trees or on the ground the crows are destroying rapidly. After the young have reached the age when they can fly well I have watched crows catch, kill and eat these little birds in the air. I have watched crows break up the nest of the meadow

lark, which builds on the ground; in fact, they kill everything they can, being extremely fond of meat. They hunt the meadows and pastures and woods every day in June and July for the young birds. I have seen crows take chickens 2 weeks old. If they can eat a robin after it can fly well and 2 weeks' old chickens they must be able to destroy young grouse and quails. Two or more crows together could easily eat young grouse and will put up a big fight to get what they are after.

If the farmers in every State knew how much good the young birds that the crows are eating up every season would do the trees they would put a stop to some of this murder. It is appalling to see the song birds killed in this way year after year, for they are indeed becoming scarce.

Anson Howard, East Northfield, Mass.

KILL THE AUTOMATIC GUN AND SAVE THE BIRDS.

I fully agree with you in what you say regarding automatic shot guns and other game-destroying firearms. Means should be adopted and proper laws enacted for the increase of game rather than the decrease. This is far from being the case. Species after species, once common, is now hastening to extinction. I well remember seeing wild pigeons in countless numbers. They flew in vast flocks or fed among the foliage of our then great forests, and to see them produced sensations I shall never forget.

Geese, ducks, grouse, wild turkeys and bay birds are becoming alarmingly scarce, while the sandhill crane, the joy of my childhood, that I so much admired as he honked and circled far above me, is almost extinct. The scattering remnants of egrets and herons that we sometimes see about the ponds and streams give no evidence of the vast flocks to be found years ago.

The clearing of the forests, drainage of the swamps, lakes and ponds, together with the bird dog and the milliner traffic, have been the chief destructive agents. The tilling and harvesting of crops have also destroyed millions of birds.

The economic value of birds as insect, weed seed and rodent destroyers is important.

Birds have been the theme of our most eminent poets throughout the ages

The L. A. S., RECREATION, Audubon societies and bird day at schools are doing much to arouse the sentiment of people in behalf of the birds. May the good work go on!

E. J. Chansler, Bicknell, Ind.

CAUGHT A RUFFED GROUSE.

One morning last summer I arose at the usual time, and went to the barn. The barn door had been open all night, as the

weather was warm. I was surprised to see on one of the roosts among the chickens a bird, called in this country a partridge, but which I am quite sure is a ruffed grouse. I called my brother, we closed the door, and commenced a merry chase. The grouse could fly as well as any wild bird, and it was several minutes before we succeeded in catching it. Fully two-thirds of its tail was pulled out when we finally captured it, but otherwise it was sound, as far as we could see. We kept the bird in a large box till the whole family had seen it, probably about an hour. Then, as that species of game bird is scarce around here, I decided to let it go. I took the bird out in my hand and gave it a little toss in the air. It flew a few rods and alighted in the garden. I followed, expecting to see it rise again, but instead of flying it merely crouched down and lay still. I tossed it up once more. That time it flew only a few feet, then alighted again and walked sedately back to the barn. It never left the place all day. Sometimes it was in the barn, sometimes just outside; but that night it disappeared. I could easily have taken some good photographs of the bird if I had had a camera.

F. T. Wood, Whitford, Alberta.

ANOTHER FRIEND OF THE SQUIRRELS.

During a trip to Homestead, Pa., not long since, I had the pleasure of a visit to the home of Mr. A. C. Noel, a department foreman in one of the Carnegie mills.

Mr. Noel, who was born among the Alleghanies, near the town of Loretto, Pa., and there spent his early days, has collected much in and about his home that reflects his early environment and inborn love for the beautiful in nature. His little colony of 4 grey and 2 fox squirrels is especially worthy of mention. Mr. Noel has arranged for them a spacious open air enclosure, where they live harmoniously, healthful and contented as in their native woods, provided as they are with so much to make them feel at home. Their nests are in some selected hollow tree trunks, on a few remaining branches of which may be seen on occasions, one or more of the bright eyed fellows deftly nibbling his lunch.

In one corner of this playground, the floor of which is carpeted with sod and even in midwinter is most refreshing, grows a compact little hemlock, and among its branches the squirrels play hide and seek.

Mr. Noel and his brother were ardent squirrel hunters in the days of the muzzle loading rifle, but they have long since ceased to find sport in hunting such lovable and interesting creatures.

N. E. M., Cresson, Pa.

In answer to H. A. Morgan's inquiry in RECREATION as to bull moose getting their horns locked, I know nothing of moose, but I know of 2 buck deer found near Eugene, Oregon, with their horns locked and one buck was dead; the other was nearly starved, past being able to stand, but had eaten all the grass within reach.

I also know of 2 bull elk with locked horns, and it was impossible to get them apart. They were nearly starved, but both were able to stand.

U. S. R., Salem, Ore.

MUSHRAT ON SHEBOYGANIN'.

I hunt mushrat when snow begin,
She like for make big haul;
I go close by Cheboyganin',
Where he make some house las' fall.

I walk all night, I walk all day,
She look roun' everywhere;
I nevare find where mushrat stay,
Maybe she all get scare.

Every day was too much blow,
All night was blow some more;
An' everywhere she pile some snow,
Like I nevare see before.

One day I stand close by bridge draw,
Some snow, some ice was float;
So much big flood from Saginaw,
She lose 'bout hundred boat.

On big ice-cake from Saginaw flat,
Somet'ing I like for see;
'Bout fifteen, twenty big mushrat,
She float down close by me.

I wish I have somet'ing for spear,
Some big, long rubber boot;
Dem nice mushrat she come so near,
I got no gun for shoot.

Dem ice-cake bust, she make me swear,
I feel so awful mad;
Some fat mushrat jump everywhere,
By Gee! dat was too bad.

George A. Williams, M. D.,
Bay City, Mich.

Mamma (teaching Dorothy the alphabet): Now think hard, dearie, what comes after t?

Dorothy: After tea, papa usually kisses the waitress, and she screams—Chicago Chronicle.

Tailor: Do you want padded shoulders, my little man?

Willie: Naw; pad de pants! Dat's where I need it most.—Chicago News.

THE LEAGUE OF AMERICAN SPORTSMEN.

GENERAL OFFICERS

President, G. O. Shields, 23 W. 24th St., New York.

1st Vice-President, E. T. Seton, 80 West 40th St., New York.

2d Vice-President, W. T. Hornaday, 2969 Decatur Ave., Bedford Park, N. Y.

3d Vice-President, Dr. T. S. Palmer, Dept. of Agriculture, Washington, D. C.

4th Vice-President, A. A. Anderson, 80 West 40th St., New York.

5th Vice-President, Hon. W. A. Richards, General Land Office, Washington, D. C.

Secretary, A. F. Rice, 155 Pennington Ave., Passaic, N. J.

Treasurer, Austin Corbin, of the Corbin Banking Co., 192 Broadway, New York.

LIFE MEMBERS OF THE LEAGUE.

Anderson, A. A., 80 W. 40th St., New York City.

Beard, D. C., 204 Amity St., Flushing, L. I.

Blackstone, Lorenzo, Norwich, Conn.

Buzzacott, Francis F., Chicago, Ill.

Brown, J. Stanford, 489 Fifth Ave., New York City.

Butler, C. E., Jerome, Ariz.

Carey, Hon. H. W., Eastlake, Mich.

Carnegie, Andrew, 2d, Fernandina, Fla.

Carnegie, George, Fernandina, Fla.

Carnegie, Morris, Fernandina, Fla.

Corbin, Austin, 192 Broadway, New York City.

N. T. De Pauw, New Albany, Ind.

Dickinson, E. H., Moosehead Lake, Me.

Edgell, G. S., 192 Broadway, New York City.

Ellis, W. D., 136 W. 72d St., New York City.

Fearing, D. B., Newport, R. I.

Ferry, C. H., 1720 Old Colony Bldg., Chicago, Ill.

Ferry, Mansfield, 183 Lincoln Park Boulevard, Chicago, Ill.

Fraser, A. V., 478 Greenwich St., New York City.

Gilbert, Clinton, 2 Wall St., New York City.

Hudson, E. J., 33 E. 35th St., Bayonne, N. J.

McClure, A. J., 158 State St., Albany, N. Y.

Mershon, W. B., Saginaw, Mich.

Miller, F. G., 108 Clinton St., Defiance, O.

Morton, Hon. Levi P., 681 Fifth Ave., New York City.

Nesbitt, A. G., Maple St., Kingston, Pa.

O'Connor, Col. J. C., 24 E. 33d St., New York City.

Oliver, Rev. F. E., Winfield, Kans.

Pierson, Gen. J. F., 20 W. 52d St., New York City.

Prescott, A. L., 90 W. Broadway, New York City.

Rice, A. F., 155 Pennington Ave., Passaic, N. J.

Rininger, Dr. E. M., 142 E. 27th St., New York City.

Seton, E. T., 80 W. 40th St., New York City.

Seymour, J. H., 35 Wall St., New York City.

Smith, E. B., Bourse Bldg., Philadelphia, Pa.

Smith, W. H., Bryn Mawr, Pa.

Thompson, J. Walter, Times Bldg., New York City.

Towne, E. S., Care of National Blank Book Co., Holyoke, Mass.

Underwood, W. L., 52 Fulton St., Boston, Mass.

Valentine, Dr. W. A., 5 W. 35th St., New York City.

H. Williams, Box 156, Butte, Mont.

DISCOUNTS TO LEAGUE MEMBERS.

The following firms have agreed to give

members of the L. A. S. a discount of 2 per cent. to 10 per cent. on all goods bought of them. In ordering please give L. A. S. number:

Syracuse Arms Co., Syracuse, N. Y. Guns.

Davenport Fire Arms Co., Norwich, Conn. Shot guns, rifles.

Gundlach Optical Co., Rochester, N. Y. Photographic goods.

Blair Camera Co., Rochester, N. Y. Photographic goods

James Acheson, Talbot St., St. Thomas, Ontario, Sporting goods.

SOUTH CAROLINA DIVISION.

During the past year the South Carolina Division of the L. A. S. has had little work to do in the upper part of the State. Since the prosecution and conviction of Wm. Sewing, the leading *restaurateur* of this city, 2 years ago, for selling quail in violation of law, we have had but little trouble, as everybody now understands that any man who may violate the game law will be prosecuted and convicted. There has not been a quail served at any restaurant in this city this winter, and the pot hunters have practically gone out of business. There were a number in this country who formerly did nothing but kill birds for market all winter, but they have all gone elsewhere or engaged in other occupations.

We have so educated the land owners that nearly all of them are in sympathy with the League, and nearly all land is posted.

When this Division of the L. A. S. was organized quails were so scarce in this county that it was not worth one's while to hunt them; but they are now fairly plentiful and are increasing in numbers.

We shall try to secure the passage of a law this winter to prevent the killing of ducks from April 1st to November 1st; also to limit the number of birds which any one man may kill in a day.

C. F. Dill, Chief Warden.

Munro Wyckoff, of Port Townsend, Wash., a local warden of the League and a State game warden as well, arrested his own brother last fall for killing grouse out of season. The offender was fined \$10 and costs, and will know better next time.

The Ithaca gun came to hand, and I am in love with it. My wife threatens to sue for divorce; she says I think more of the gun than I do of her. Expect to have good times this fall in duck season.

W. E. Bedell, Montpelier, Ia.

FORESTRY.

It takes 30 years to grow a tree and 30 minutes to cut it down and destroy it.

FOREST RESERVES AND FORESTRY.

The first step in revising and reorganizing the administration of the public domain, a project agitated in Congress for years, was the appointment by the President of a special commission to investigate and report on the present situation. This commission was composed of Mr. Gifford Pinchat, Chief of the Bureau of Forestry; Mr. F. A. Newell, chief engineer of the Reclamation Service, and Governor Richards, Commissioner of the General Land Office.

Inasmuch as grazing on the public lands is the most vital question in the land policy of the United States, the commission used every effort to attain the closest possible appreciation of the sentiment and attitude of the grazing interests toward the proposed revision of the land laws, the forest reserves, and the various irrigation projects.

The most interesting information they secured was from attendance on the joint convention of the National Live Stock Association, representing the cattle interests, and the National Woolgrowers' Association, representing the sheep interests, which was held at Portland, Oregon, in January. Inasmuch as the sheep and cattle owners have always been supposed to be opposed to the reserving of forested public lands from homestead entry and managing them as forests, the discussions and conclusions reached are of great interest to the country generally, and to foresters particularly. In brief, the almost unanimous attitude of the convention was as follows:

First.—Strong approval of the forest reserve policy.

Second.—A petition praying for the passage of the bill, now before Congress, for the transfer of the administration of the forest reserves from the General Land Office to the Bureau of Forestry.

Third.—The recognition that the stock industry must be protected from the present injurious competition between the sheep and cattle men, resulting in a war for the free range.

Fourth.—A general desire that the Government step in and take control of the range, allotting grazing privileges, fairly and justly to the various owners, and making rigid laws and regulations therefor.

Fifth.—That the Congressional appropriation for the care of the forest reserves be made ample to insure a thorough, practical and business-like administration in proportion to the magnitude of the interests involved.

The far-reaching significance of these con-

clusions by the most powerful and the most dangerous interests to be met with in the settling of these questions may not occur to the casual reader. They mean that the present lawless tangle in the fight for existence between sheep and cattle growers is nearing an end and that we may soon see a just and fair division of the grazing privileges which will be accepted and defended by these men. They also mean that the most serious thing in the administration of the reserves will be unloaded from the shoulders of the Government, and that those locally in charge of the various forest reserves will know where they stand and feel that they have the authority of these two great associations and the arm of the Government back of them in enforcing the reserve regulations.

But what is most important to the profession of forestry, these resolutions mean that a brand new field, calling for the best men the country grows, is to be opened for foresters. Just how many trained foresters will be required it is impossible at this writing to say.

There are now over 60 million acres of forest reserves, which the Bureau of Forestry will have to manage in accordance with forestry principles. The British Government has practically the same area in India and the English Forestry Service, which manages and cares for this Government forest, comprises nearly 15,000 men. Our own forest reserves are of as great importance and value to the nation's greatness, and it is not extravagant to suppose that in time we may have a forestry service comparing in size and importance with the English service.

The final report of the special commission is now in preparation, and will be looked forward to with great interest by all concerned in the administration of the public domain.

THE PROPOSED FIELD SERVICE CLUB.

The constantly increasing numbers of men in the Federal Civil Service who are out in the field half the year and come back to work up their field data in the Government offices in Washington have created a demand for some sort of social club wherein these men of similar tastes and occupations can meet and perhaps live during their tour of duty at the Capitol.

The Army and Navy Clubs have always been a boon to the wandering members of both services, and have invariably been successful and self-supporting. Of course, from the very nature of their duties and

traditions these services have a link and *esprit de corps* that it will be impossible to duplicate in the civilian Federal service for a long time; but that this feeling is slowly but surely developing in Washington there is every hope.

The popular idea of the civil service has undergone a wonderful change in the last two years. An entirely new class of men are being attracted by the opportunities offered by the various Federal departments. The very fact that political pull and influence has well nigh been completely eliminated from appointments and advancement has changed the type of the Government men and fostered the good opinion of the public. Heretofore the only Government service open to the ambitious young man was in the army and navy, and we found the other services full of ward politicians and bewhiskered grangers from the Middle West. To-day we find the best type of young college men going into what might be well called the professional Federal departments, such as the Geological Survey, the Bureau of Forestry, the Reclamation Service, the Bureau of Soils, the Bureau of Animal Industry, the Bureau of Plant Industry, and the various bureaus in the new colonial service.

The Bureau of Forestry particularly has attracted a class of men that never before thought of the Government service as a career. Probably the attractive nature of the work and the great attention which has been attracted to forestry as a profession accounts for this. The out of door life and the independence of action strongly appeals to the typical young American, especially if he is fond of hunting and fishing. The general opinion abroad may be that the typical American is a slave to trade and is imbued only with money getting instincts, but the facts do not bear this opinion out. The typical American is just as good a sportsman as the Englishman, when opportunity permits. It would undoubtedly be vigorously denied that the sporting instinct has any considerable influence on a young man in choosing such a profession as Forestry, but it would not be denied by any one that other qualifications being equal the sportsman will make very much the best forester.

Within the various Federal bureaus there has arisen a pretty good spirit of sympathy and comradeship, but there has never been an opportunity for the members of the different branches to get together. The Cosmos Club in Washington, to be sure, is largely composed of the scientific men in the Government service, but it does not offer the tone required, and but very few of the younger men engaged in active field service belong.

The new club proposed would be unique

in this country, and should receive the enthusiastic support of the entire civilian Federal service.

A committee consisting of Capt. J. B. Adams, Mr. Thomas A. Sherrard, Mr. George Woodruff and Mr. Coert Du Bois, all of the U. S. Bureau of Forestry, are now engaged in looking up a suitable house and making arrangements for the organization of the club.

FOREST FIRES.

Every summer and autumn large areas of public and private forests are devastated by fire. This destruction is a universal injury. It not only destroys a valuable asset of the country, but it is productive of floods. The forest is the most effective means of preventing floods and producing a more regular flow of water for irrigation and other useful purposes.

To prevent the mischievous forest fires Congress has enacted a law which forbids setting fire to the woods, and forbids leaving camp or other fires without first extinguishing them.

The law provides a maximum fine of \$5,000, or imprisonment for 2 years, or both, if the fire is set maliciously, and a fine of \$1,000, or imprisonment for one year, if the fire is due to carelessness. It also provides that the money from these fines shall go to the school funds of the county in which the offense is committed.

Hon. W. A. Richards, commissioner of the General Land Office, has issued circulars, warning the public against carelessness, inasmuch as many fires start from neglected camp fires, and makes the following suggestions:

Do not build a larger fire than you need.

Do not build your fires in dense masses of pine leaves, duff and other combustible material, where the fire is sure to spread.

Do not build your fire against large logs, especially rotten logs, where it requires much more work and time to put the fire out than you are willing to expend, and where you are rarely certain that the fire is really and completely extinguished.

In windy weather and in dangerous places dig a hole and clear off a place to secure your fire. You will save wood and trouble.

Every camp fire should be completely put out before leaving the camp.

Do not build fires to clear off land and for other similar purposes without informing the nearest ranger or the supervisor, so that he may assist you.

As hunters, anglers and campers will soon haunt the woods and streams, it is hoped that newspapers everywhere will circulate this warning and information.

SPRING FIELD WORK AT YALE FOREST SCHOOL.

The senior class of the Yale Forest School left for Pike County, Penn., for their annual spring tour of duty in the woods, April 22, and will remain until Commencement, June 29. There are 35 men in the class who will graduate in June. The party will work under the direction of Prof. Graves, director of the school, and Prof. Marston, in charge of Forest Engineering. Mr. Austin Cary, forester of the Berlin Mills Company, who is the oldest practicing forester in this country, will assist in the instruction.

The men will make a topographical map and a plan for the management and protection of a forest tract in Pike county, besides doing a large amount of special scientific work.

The class of two years ago spent the spring term on the forest estate of Mr. E. H. Harriman in Orange county, New York, and made a plan for the manage-

ment of its 15,000 acres. Last spring the class did a like piece of work on the U. S. Military Academy Forest Reservation at West Point.

U. S. BUREAU OF FORESTRY NOTES.

Nearly all the field men of the Bureau of Forestry are still in Washington, working on the reports for which they secured data last season. It is not likely that any forestry parties will be sent out until the first of July. The distribution of the men for this summer's work is a mystery, owing to the fact that there is a possibility the Bureau may be called on to take charge of the forest reserves, in which case it will have to withdraw its attention somewhat from private land work and concentrate its energy on the big problem.

The appropriation this year by Congress, for the Bureau, will be \$425,140, about \$75,000 more than last year's allotment.

GENEALOGY.

C. C. H.

When the swine with the devils inside,
tra la,
Went galloping down to the sea;
The legion was properly mad, tra la,
As angry as devils could be.
They ripped and they swore,
And their raven locks tore,
And vengeance most dire
They vowed in their ire
They'd wreak on the fish in the sea, tra la,
They'd wreak on the fish in the sea.

So they grabbed each an armful of
bristles, tra la,
From the backs of the porkers so mad,
And carried off all the swine tricks,
tra la,
The hogs so unfortunate had.
They took them on land,
Fixed them up to stand,
And shouted in glee
On the shore by the sea:
"A brand new creation we've made, tra la,
A brand new creation we've made.

Then the head devil spoke in command,
tra la,
To this monster the evil ones made:
"You are now to go forth to destroy,
tra la,
And murder henceforth is your trade,
No law you'll obey
In the night or the day,
But just sail in and kill
All the fish that you will,
And the first of the fish hogs you'll be,
tra la,
The first of the fish hogs you'll be."

And from so minute a beginning, tra la,
The fish hog has spread in the land.
His brother, the game hog, is here, tra la,
Like twins they are seen hand in hand.
But there is a big pen
No respecter of men,
And a numbering brand
Held by Coquina's hand!
Here's hoping he'll keep the iron hot, tra la,
Here's hoping he'll keep the iron hot.

"Folks say you only married me because I have money."

"Nonsense! My principal reason for marrying you was because I had none."

PURE AND IMPURE FOODS.

Edited by C. F. LANGWORTHY, PH.D.

Author of "On Citraconic, Itaconic and Mesaconic Acids," "Fish as Food," etc.

"What a Man Eats He Is."

MACARONI WHEATS.

Macaroni wheats have from time to time been introduced into the United States during the past 35 years, but lack of demand for them has until recently prevented any extensive culture of these wheats, although "Wild Goose," or "Goose," an inferior grade of macaroni wheat, has long been grown to some extent in Canada and the Northwestern United States. A few years ago, however, the Department of Agriculture undertook systematic work with a view to introducing improved varieties of macaroni wheats and building up a home market and foreign demand for macaroni flour. The Agricultural Experiment Stations and private individuals have co-operated effectively with the Department in testing the wheats under varying conditions and in studying the qualities and uses of the product. This work has been so successful that there is good reason for the belief that the United States will in time not only produce all the macaroni it consumes, but supply a considerable proportion of the macaroni and macaroni flour used abroad.

These wheats are especially adapted to growth in the semi-arid regions of the United States, and render possible the building up of a profitable industry in regions in which ordinary wheats do not succeed and which, without irrigation, are of little or no value except for grazing purposes. The macaroni wheats have been found to give the best results on the Great Plains near the 100th meridian, but they may be successfully grown over a wide area.

The macaroni wheats are much harder than the ordinary hard wheats. In composition they differ from ordinary wheats in having a smaller percentage of starch and a larger percentage of protein or nitrogenous matter. In samples examined by Professor Shepard, of the South Dakota Experiment Station, the protein varied from 13.9 to 18.8 per cent. Ordinary wheats have on the average 11.8 per cent of protein. As a consequence of the higher protein content of the macaroni wheats the flour and by-products yielded by them are also richer in this valuable food constituent than those obtained from ordinary wheat. South Dakota macaroni wheat flour contained 16.9 per cent. of protein, the bran 16.3 per cent., and the shorts 17.4 per cent. Ordinary wheat flour on an average contains 11.4 per cent. of protein, bran 15.4 per

cent., and shorts 14.9 per cent. The flour, or, as it is termed, semolina, from macaroni wheats makes a richer macaroni than that of ordinary hard wheats, which has been used to a considerable extent by macaroni manufacturers. Macaroni of the highest quality was made from the macaroni wheats grown in South Dakota, and analysis showed it to contain 16.5 per cent. of protein. The inferior quality of the macaroni made from flour of ordinary wheats is generally recognized in the trade. This has resulted in an increasing demand on the part of macaroni manufacturers, which has only partly been met by the millers, for semolina from macaroni wheats. It is safe to assume that as this demand increases the millers will be induced to make the slight alteration in their milling machinery necessary to grind the macaroni wheat and will supply the flour required for our growing domestic manufacture as well as for an increasing export trade.

If, however, all of the macaroni wheat grown can not be disposed of profitably for the manufacture of macaroni, it may be used to advantage as a feeding stuff or for bread making, as is done in Russia and other European countries. The South Dakota Experiment Station has shown that macaroni flour can be made into a sweet bread of good flavor and of average composition. It has also been demonstrated to be well suited to the preparation of biscuits, muffins, griddle cakes, and similar products of good quality. For bread it is often considered desirable to mix 20 per cent. or more of red wheat flour with the macaroni wheat flour.

BACON.

Many who are fond of bacon hesitate to eat it, as they find that it causes indigestion. In a large number, if not the majority of cases, this is due not to the fatty nature of the food, but to the fact that the bacon was overcooked, or rather, cooked at too high a temperature. It is not surprising that this should be the case when we remember that fat heated to a high temperature is decomposed and that one of the products given off is acrolein, an unpleasant smelling compound which attacks the eyes, making them smart, and irritates all mucous surfaces. Acrolein is plainly noticeable in the acrid fumes of burning or

scorching fat. When bacon fat is heated to 350 deg. F., this chemical change is brought about to a greater or less extent. Very often bacon is hurriedly cooked in a hot frying pan over an extremely hot fire, and more or less scorched fat is an almost inevitable result. If broiled, there is less chance of scorching the fat, but the edges of the bacon are often burned, and this is equally unwholesome. Great care should be taken to avoid too hot a fire. With moderate heat, bacon may be cooked to a golden brown, either crisp or not, as may be preferred, and there will be no indigestion from scorched fat. The wholesomeness of well cooked bacon and a way of cooking it, were pointed out in a recent magazine, in a discussion of the diet for children's hospitals.

Fat is a necessary item in a child's dietary. It is especially indicated for thin, nervous children, and for such as have frequent colds or catarrhal disorders. Children are fond of cream; but, though cream is not so expensive as butter, it is generally thought too dear for common use in institutions.

Most children like bacon, and tender, mild cured bacon is considered a wholesome form in which to eat fat. Hence a careful, painstaking cook is needed to cook even the simplest articles of food, that they be sent to the table in a condition fit for the stomach of a child. Cook the bacon in a slow oven, in a hinged broiler, set over a dripping pan. The crisp, delicately cooked slices will be eaten with avidity by even small children.

TEA, COFFEE AND COCOA.

Judging by official figures recently compiled, Americans are apparently becoming greater tea drinkers, for in 1903 the net imports of that article were 104,632,260 pounds, against 73,374,041 in 1902. Compared with the preceding years the imports from Japan increased more than 7,000,000 pounds, and there was an increase from China of more than 19,000,000 pounds. The gross imports of coffee in the fiscal year 1902 were 1,091,004,380 pounds, while in 1903 only 915,555,380 pounds came in. Despite the falling off in imports, which was probably due to the market having a large supply on hand, the quantity transshipped and exported was 47,701,306 pounds, against 34,462,615 pounds in the previous year. It is interesting to note that the per capita consumption of coffee is about 13 pounds, while that of tea is 1½ pounds. The price of tea, however, is more than double that of coffee.

The Department of Commerce and Labor, through its Bureau of Statistics, shows

that the importation of cacao has grown from 9,000,000 pounds in 1883 to 24,000,000 pounds in 1893, and 63,000,000 pounds in 1903. The value of importations of cacao in crude form has grown from \$1,000,000 in 1883 to \$4,000,000 in 1893 and nearly \$8,000,000 in 1903. Meantime the importation of manufactured cacao and chocolate has fallen from 1,467,977 pounds in 1897, valued at \$239,819, to 690,824 pounds in 1903, valued at \$144,823.

The growth in the importation of cacao has been more rapid proportionately than that of coffee, and much more rapid than that of tea. Other evidence of the growth in consumption and popularity of cacao and its product, chocolate, in the United States is shown by the fact that the number of cacao and chocolate manufacturing establishments reported in the census of 1880 was 7; in 1890, 11, and in 1900, 24, while the capital employed increased from \$530,500 in 1880 to \$6,890,732 in 1900. The value of materials used in manufacturing grew from \$812,403 in 1880 to \$6,876,682 in 1900, and the value of the product from \$1,302,153 in 1880 to \$9,666,192 in 1900.

KEEPING QUALITY OF BUTTER.

Experiments carried on at the Iowa Agricultural Experiment Station show that water used in washing butter contains germs which cause it to deteriorate in quality. It was found that these germs can be removed or destroyed in a practical and inexpensive way by 2 processes, viz., pasteurization or filtration of the water.

Butter washed in pasteurized water will retain its normal qualities much longer than the same butter washed in unpasteurized water, while butter made from pasteurized cream and washed in pasteurized water retains its normal flavor about twice as long as butter made from unpasteurized cream and washed in water which has not been thus treated. Unwashed butter made from good and well ripened cream kept as well as, and in some instances better, than the same butter when washed in unpasteurized water. Experiment showed that salt, as is commonly believed to be the case, improves the keeping quality of butter.

It pays to pasteurize the wash water as well as the cream. The expense of pasteurizing milk and water, not counting the original cost of the pasteurizer, is about .1 of a cent a pound of butter. From the standpoint of the producer the conclusion is important that the increased value of butter by pasteurization when about a month old, is .8 of a cent, which is equivalent to an extra profit of .7 of a cent a pound for butter thus treated.

EDITOR'S CORNER.

DECLINED WITH THANKS.

The Winchester Arms Company has instructed all its traveling men to join the L. A. S., and 23 of them have applied for membership. Here are a few of their letters:

Denison, Texas, March 24, 1904.
Mr. A. F. Rice, Secretary,
League of American Sportsmen,
23 West 24th Street, New York.
Dear Sir: Replying to your favor of the

been instructed by the Winchester Company to apply for membership, though, as will be seen by the reproduction of their letters, 2 of the men inadvertently used Winchester stationery.

These 3 men will undoubtedly be vigorously called to account when Mr. Bennett sees this issue of RECREATION.

Several of these men have already called on division officers of the League and have asked for lists of the names and addresses

Address all letters to

WINCHESTER
REPEATING ARMS CO.
NEW HAVEN, CONN.

Bismarck N.D. Sept 1904

*Mr. A. F. Rice
Passaic
N.J.*

Dear Sirs:

As I am representing the Winchester Repeating Arms Co. in north and south states they wish to have me become a member of the League of American Sportsmen you will please find enclosed \$1.00 and dollar for initiation fee which I understand is the amount required. Hoping that this application may meet your approval.

*Yours respectfully,
James Collins.*

8th inst., relative to a membership in the League, beg to advise that my permanent address is 130 Hibernia Street, Dallas, Tex. My occupation is that of a commercial traveler, and I represent the Winchester Repeating Arms Company, New Haven, Conn.

Trusting that this is all the information you desire, I beg to remain,

Yours truly,

Alex White.

The others used either hotel letter heads or plain stationery, simply stating that they were traveling men. Mr. Collins is the only man of the lot who stated that he had

of the members in their respective States. Judging from this and from the fact that the Winchester Company is fighting RECREATION tooth and nail, it is obviously the purpose of the company in instructing its salesmen to join the League to be able to have spies in our camps all over the country.

When these facts developed, a meeting of the Membership Committee of the League was called to consider the applications. This committee consists of W. T. Hornaday, Ernest T. Seton and Arthur F. Rice. Mr. Rice and Mr. Hornaday attended the meeting and after canvassing the

Address all letters to

WINCHESTER.
REPEATING ARMS CO.
NEW HAVEN, CONN.

Columbia SC 2/21/1904

Mr. A. A. Rice, Secy
#155 Pennington Ctr
Passaic N.J.
Dear Sir
I desire to become
a member of the League of
American Sportsmen and
enclose \$1.00 to pay my initiation
fee. Thanking you in advance
for the Country Club
Law, Very truly yours
J. DeS. Porter
C/O Wrights Hotel
Columbia S.C.

applications carefully decided that it would not be well to allow these 23 Winchester traveling men to belong to the League. The secretary was, therefore, instructed to drop from the rolls the names of 7 of the men whose names had already been placed thereon, and to return to the other 14 men the sum of \$1 each which they had remitted with their applications.

I am still getting large numbers of letters written by the Winchester Company to readers of RECREATION and which are forwarded to me. While the Winchester people insist that they do not intend to make an automatic gun, yet they defend that slaughtering machine vigorously. The burden of Mr. Bennett's song is that the automatic gun is up to date; that it is the highest type of shooting iron thus far invented, etc. Dynamite is up to date, too, but when a man uses it to fish with the law steps in and lays an iron hand on him. Viewed from the standpoint of a man who wants to kill everything in the country, the automatic gun is a big improvement on anything heretofore produced, and for that reason its use on birds should be prohibited by law.

The so-called sportsmen of Iowa have succeeded in defeating a bill introduced in the legislature of that State last winter, aiming to prohibit the shooting of wild fowl in spring. The same men have also killed a bill which aimed to provide a close season on prairie chickens for 3 years, in order that they might recuperate from the effects of the war of extermination which has been waged against them for many years. All real sportsmen will regret this action, and it is hoped these latter may succeed in passing an anti-spring shooting law at the next session of the law-making body.

Does any reader of RECREATION know the present whereabouts of A. L. Meigs? If so, I should like to have his address. There are indictments pending against him in 3 States for obtaining money under false pretenses, and I should like to be able to put the sheriffs of the respective counties in which he did this work on his trail.

"Did you notice the perfume as she passed?"

"Yes, she is probably a Colonial Dame."
—Exchange.

THE MONARCH OF THE POOL.

F. H. ROCKWELL.

There is a large pool in a Northern Pennsylvania trout stream that a true angler would pronounce the prettiest he ever saw for large trout. Even an ordinary angler was usually rewarded by the capture of some of its inhabitants.

A certain trout of that pool came at last to be known as the monarch. I knew him well. My first experience with him was in June, 1897. I had gone out for the afternoon and after catching from that pool 2 or 3 medium sized trout, I started up the stream. I had gone 40 or 50 rods above the pool when I hooked a beauty, about 11 inches long. There was a pile of drift across the lower end of the hole and I had considerable trouble in keeping clear of the logs, but I finally succeeded in landing him. Much elated, I clapped him in the basket. As I did so, I noticed a white strip across his back, near the head.

It was getting late and I started down the stream again. In order to fish the next hole properly I had to wade. I was not successful there and concluded to take another look at my big fish. He was not in the basket. The cover had become loose and he had flopped into the stream. I leave it to the imagination of the reader as to how I felt when I made this discovery. I had but one consoling thought: he is in the water and some other fellow may have a chance at him.

This monarch trout was seen by many persons during the seasons following. He must have grown wonderfully to judge by the size different persons gave him. He was anywhere from 15 inches long to 2 feet; but it must have been the same trout, as everyone who saw him agreed that he had a large white stripe across his back, and all accounts placed him in that particular pool. The amount of fishing done for that trout was incredible. In the spring of 1901 I took my little boy, 8 years old, to that stream. He wanted to fish, like me. Accordingly, I cut a willow pole, tied a hook on a piece of old line, attached the line to the pole, and put a lively worm on

the hook. After getting the boy at his work I set about mine. A heavy shower came up and we took to a shed for shelter. The shower was soon over and the boy wanted to go back to the pool to fish. He said he had seen a fish that he thought must be a young whale, and asked me how long a whale is. I was, however, discouraged by my own failure and said the boy could fish till I got the horse, when we would go home.

I had just hitched the horse to the wagon when I heard a scream and a loud splash. I was behind some brushes from the pool and could not see what was happening. Fearing something was wrong, I ran over to the pool. The boy was in the swift water at the head of the pool and floating down where it was 6 or 8 feet deep. He seemed towed along, as he had hold of his willow pole and was part of the time under water. He went down toward the eddy. Then the towing stopped and the boy sank. I jumped in and after considerable effort I got hold of him. When I tried to wade out there seemed to be a drag. The boy still held to the pole; the line was wound around him, and there was something tugging viciously out in the water. I got my boy's head above water, and he exclaimed:

"I've got him!"

I appreciated the joke and said,
"I guess I've got him."

Gradually we approached shore, but still felt something tugging back all the time. I began to think may be the boy was right and that he had got something. When the boy was safely out of the water the line dragged out the big trout, the "Monarch of the Pool."

It was surprising that he did not break loose, but on examination I found he had swallowed the hook, worm and all, and was firmly hooked in the throat. That white mark was across his back. He was 17½ inches long and weighed a trifle over 2 pounds.

"Now, William," said the man of business to the office boy, "I am going out to get shaved."

"Yes, sir. Barber's, sir, or Wall street."
—Yonkers Statesman.

THE HILL OF TARIK IN AMERICA.

HERBERT S. HOUSTON.

With Photographic Illustrations by Arthur Hewitt.



From Madeira the ship's course was straight for the Mediterranean. Among those on board, bound for the Orient, were a New York publisher and a bright boy from the West, eager for all the new sights of the old world ahead. As the land breezes caught the pennant

at the masthead, the boy scanned the Eastern horizon and he kept it up for hours.

"What are you looking for so hard?" inquired the publisher.

"Oh, I want to see that big sign of the Prudential on Gibraltar," and the boy still peered into the East. When at last the great rock, the Hill of Tarik, the Saracen, lifted its head above the ocean the boy searched in vain for the sign he was sure he would see. For him, as for all other Americans who read the magazines, the Prudential was inseparably associated with Gibraltar. And this association has made the rock and the insurance company almost interchangeable terms, simply because each suggested strength. But the American Gibraltar achieved its strength in a few years, by dauntless human endeavor while the slow accretions of ages gave strength to its namesake, the mighty Hill of Tarik.

Ten years after the close of the Civil War—a period so recent that its history has scarcely been written—the Prudential was established in Newark. As if foreknowing the great rock to which it would grow, it began its foundation in a basement office. It was like the beginning of the New York Herald by Bennett, the elder, in a basement on Ann street. But it would be an idle play with words to make a basement office the real foundation of the Prudential. It was something much deeper down than that—nothing else than the bedrock American principle of democracy. The Prudential applied the democratic principle to life insurance. As Senator Dryden, of New Jersey, the founder of the company, has said, "Life insurance is of the most value when most widely distributed. The Prudential and the companies like it are cultivating broadly and soundly among the masses the idea of life insurance protection. To them is being carried the gospel of self-help, protection and a higher life."

And what has been the result of the democratic American principle worked out in life insurance? In 1875 the first policy was written in the Prudential. At the end of 1903 there were 5,447,307 policies in force on the books of the company, representing nearly a billion dollars. The assets in 1876 were \$2,232, while twenty-seven years later, in 1903, they were more than 30,000 times greater, or \$72,712,435.44, the liabilities at the same time being \$62,578,410.81. This is a record of growth that is without precedent in insurance and that is hard to match in the whole range of industry. The rise of the Prudential to greatness reads like a romance in big figures, but, in fact, it is a record of business expansion that has been as natural as the growth of an oak.

The corn crop of the country seems too big for comprehension until one sees the vast fields of the middle West, and then it appears as simple as the growth of a single stalk. So with the Prudential. To say that,

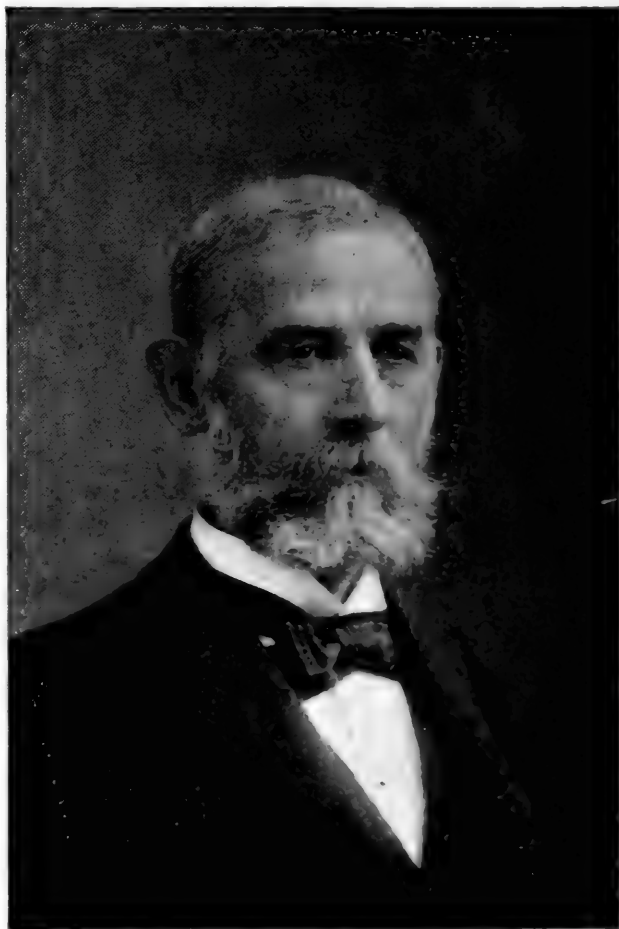

U. S. SENATOR JOHN F. DRYDEN,
President of the Prudential.

in 10 years, the company's income grew from something more than \$9,000,000 a year to more than \$39,000,000 last year is amazing as a general statement, but when made in relation to the broad principles on which that growth has been based, it becomes as much a matter of course as the corn crop. There is no mystery about it; but there is in it, from the day when the principles were planted in Newark until these great harvest days, the genuine American spirit of

propaganda. The company's organization is essentially military. It is a wonderful combination of big grasp and outlook with the most painstaking thoroughness and system in details. And, as is always the case in every organization that throbs throughout with intelligent energy, there is a man at the center of it. This man has a constructive imagination lighting up a New England brain. To business prudence there is added the large vision which sweeps the



HOME OFFICES, PRUDENTIAL INSURANCE CO., NEWARK, N. J.

achievement, strong, hopeful and expansive.

The Prudential Insurance Company of America is a national institution. It was founded to provide insurance for the American people on the broadest possible basis, consistent with strength and safety.

Just as Grant and Lee organized their armies, or as Kouropatkin and Yamagata plan their campaigns in Asia, so does the Prudential work out its national insurance

horizon for opportunity. Naturally, to such a vision the application of the democratic idea to insurance was an opportunity of the first magnitude. When seen, it was grasped and developed. The Prudential was founded. In the most careful way, its idea was tested, just as the Secretary of Agriculture tests seeds at the Government's experiment farms. Here was where prudence kept the large vision in proper focus. Gradually

the idea took root and grew. Year after year the Prudential added to its number of policyholders and all the time the company was working out a more liberal basis for its democratic idea. But each time a more liberal policy was offered, it was fully tested. "Progress with strength" is the way President Dryden describes the company's principle of growth—the results, clearly, of vision and prudence. At the end of ten years of this method of growth, the company reached the point where, it was believed, insurance could be safely offered for any amount with premiums payable on any plan, either in weekly instalments or at longer periods. Within the five years, 1886 to 1890, inclusive, the company's assets increased nearly five fold, from \$1,040,816 to \$5,084,895, and the amount of insurance in force from \$40,266,445 to \$139,163,654.

The Prudential had found itself. The idea of democratic insurance had been fully tested and adjusted to the needs and conditions of the American people. Then, with a boldness which only large vision could have quickened, the plan was formed to make the Prudential's idea known in every section of the country. Gibraltar was chosen as the symbol of the company's strength, and advertising—the telling of the Prudential idea to the people—was begun.

The Prudential publicity is accompanied by wise promotion from a field force of over 12,000, some of whom have been with the company for over a quarter of a century, working in almost every state of the Union. They have the zeal of Crusaders and it is kept at ardent pitch through an organization that could not fail to produce a wonderful esprit de corps. Wise direction and constant encouragement come from the home office, and then the company's agents are grouped in districts, under superintendents and assistant superintendents, managers, general agents and special agents, and in each district a strong spirit of emulation is developed by human contact and co-operation. Weekly meetings are held, and the problems of wisely presenting insurance are discussed. Comparative records of the men are kept in many districts, and prizes are offered for those writing the largest volume of business, for those making the greatest individual increase, and for many other contests. This wholesome rivalry produces an alertness and industry which are to the company an invaluable asset in human efficiency. A few weeks after this magazine appears, probably 2,000 agents of the Prudential—those who have made the best records for the year—will be brought to Newark from all parts of the country. They will, of course, visit the home offices and come in contact with the directing center of their wonderful organization.

And, after all, there is no place where one

feels the greatness of the Prudential quite so much as in the vast granite piles which have been raised for the company's home buildings. They rise above the Jersey meadows as Gibraltar does above the sea, a convincing witness, surely, to the growth and to the strength of the Prudential. But they are not a cold, gray rock, but a living organism throbbing from vital contact with millions of policyholders. There are now four of these great buildings, all occupied by the company. In one of them is the Prudential's publishing plant, which, in equipment,



THE WHIRL OF THE ENGINES.

surprising as this may seem, is equal to that of almost any publishing house in the country. Millions of booklets, two publications for the company—one, "The Prudential," with a circulation of more than two millions—and the policies are all printed here, besides no end of commercial printing for the home office and for the district agencies. The big composing room, the pressroom, with its eighteen presses, the bindery with its folding, cutting, sewing and numbering machines, are models of cleanliness and light. But, for that matter, all the buildings are as spick and span as a man-o'-war. There are subways, well lighted, under the streets, connecting the different buildings. In every way there has been, in the arrangements, a conservation of energy and time to produce economy and efficiency in carrying on the company's vast business. As indicating how vast that is, the mail coming to and going from the Prudential is nearly as large as for all the rest of Newark, a city with more than 250,000 population and of great industrial importance. The mailing department is really a big city post office.



THE PRUDENTIAL TOWER.

And in all the departments one gets the feeling of size that comes in the enormous government buildings at Washington. And it is as a national institution that the Prudential always fixes itself on the mind—its fundamental idea of democracy in insurance, its nation-wide organization for spreading the idea, its essentially American spirit throughout, all make the company worthy of its name, the Prudential Insurance Company of America.

To-day the Prudential is paying over 300

claims a day, or about forty each working hour. On many policies settlement is made within a few hours by the superintendent of the district; on the large policies a report is sent immediately to the home office and settlement authorized by telegraph. And on over 45 per cent. of the claims more money is paid than the policy calls for. From the beginning the Prudential has followed lines of great liberality, whether in dealing with the family where the policy is kept in the bureau drawer, or with the estate of the millionaire.

It would be interesting to describe the broad activities that hum in the great buildings at Newark, but they would more than require an entire article themselves. So, too, with the equipment and furnishings of the buildings which, in the way of complete adjustment to their particular work, are probably unequaled in the world. For example, in the actuarial department is a card machine, invented by the actuary of the company, which can do all but think. But many of these things, in miniature, will be seen by the thousands who go to the World's Fair at St. Louis. They will find in the Prudential's exhibit in the Palace of Education, a fine model of all the buildings, and also the fullest data concerning life insurance that have ever been brought together.

But the last word about the Prudential is not told at any exposition. It is found in the 5,500,000 policies which form a stupendous exhibit on the value of life insurance in developing thrift, safe investment and home protection in a nation. Of course, such an exhibit could never have been possible if the Prudential had not worked out safe policies that would meet the broad needs of the American people.

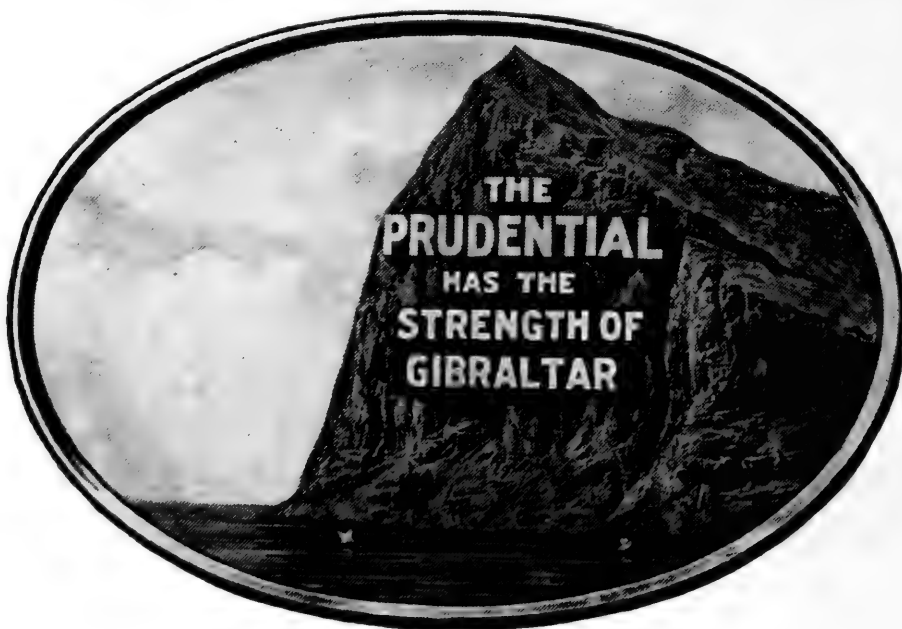

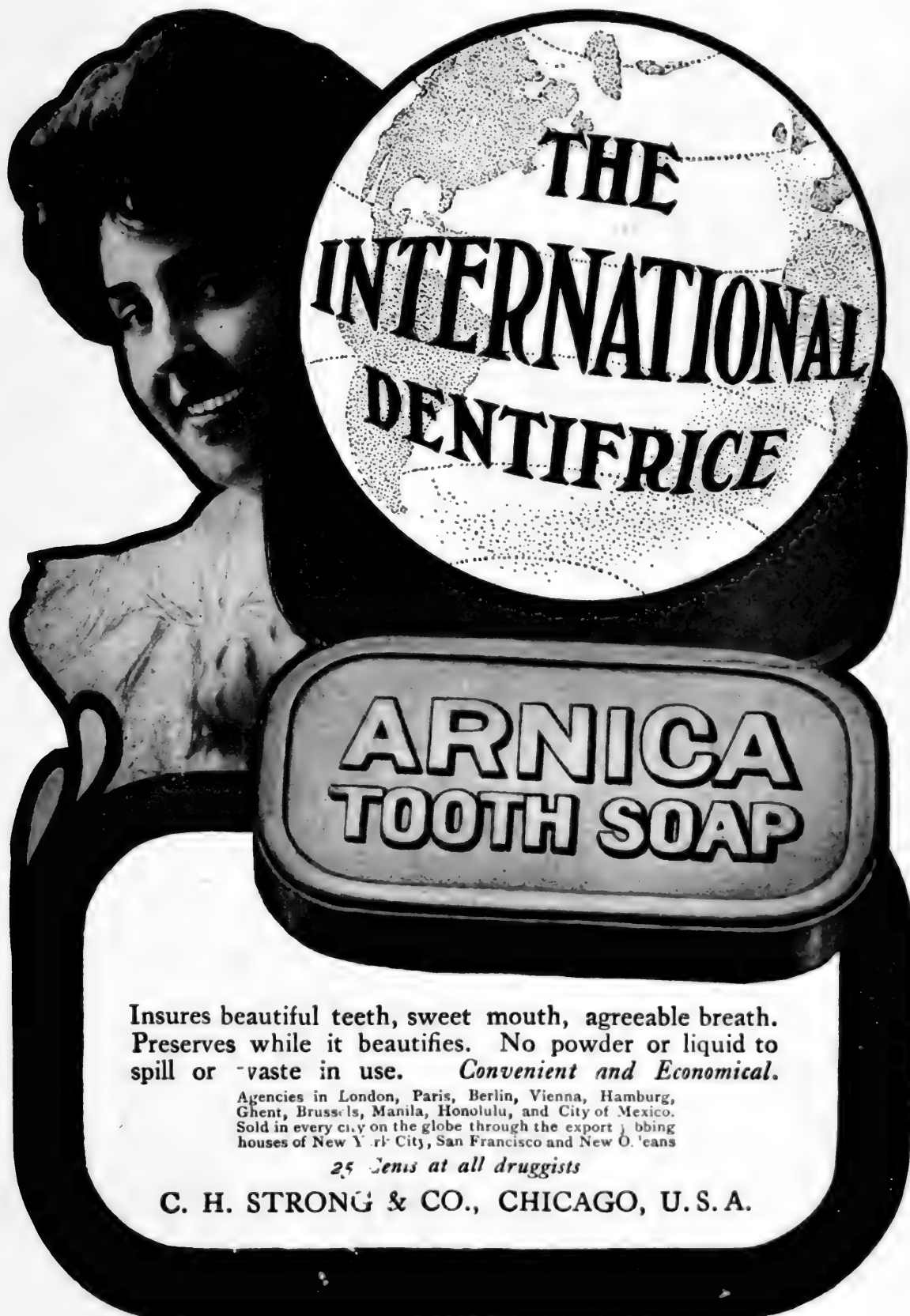

THE
INTERNATIONAL
DENTIFRICE

ARNICA
TOOTH SOAP

Insures beautiful teeth, sweet mouth, agreeable breath.
Preserves while it beautifies. No powder or liquid to
spill or waste in use. *Convenient and Economical.*

Agencies in London, Paris, Berlin, Vienna, Hamburg,
Ghent, Brussels, Manila, Honolulu, and City of Mexico.
Sold in every city on the globe through the export
houses of New York City, San Francisco and New Orleans.

25 Cents at all druggists

C. H. STRONG & CO., CHICAGO, U. S. A.

HAD A FISH STORY OF HIS OWN.

HARMON W. MARSH.

There once was a lad with the gift of gab,
 a wonderful gift had he,
 And he told more tales of big fish caught
 than if he had drained the sea;
 There came a time when he had to leave
 and cross to the beautiful shore,
 But the habits acquired on this mundane
 sphere, they all of them followed him
 o'er.

Whenever he saw an angel band, grouped
 on the golden street,
 He'd butt his way to the center, sure, and
 one of his tales repeat.
 There was one little saint with a shriveled
 form, of quiet and weary mein,
 Who, whenever one of these tales was
 sprung, looked as if it gave him a
 pain.

He'd stand on the edge of the angel throng,
 till the story was told complete,
 Then rustle his wings with a grunt of dis-
 gust, and silently cross the street.
 The guy with the stories was piking around
 to learn the impression made,
 And he saw that all of the angel band ex-
 cepting this little one stayed.

It grated his nerves that this one old boy,
 Couldn't stomach the tales the rest would
 enjoy,
 And the more he pondered, the more he
 got sore,
 He had never been treated like that before;

So he hiked him along down the golden
 street till he came to the golden gate,
 And he roused up the saint who tended the
 door, his tale of woe to relate.
 And when he had finished he asked the
 saint, "Who is that egregious brute?"
 And the saint replied with a kindly smile,
 "That 's Jonah, you blamed galoot."

The Fulton County Rod and Gun Club, a chartered organization now 2 years old, holds 6,000 acres of fine hunting and fishing ground in the Blue Ridge mountains. Game is plentiful and consists of rabbits, grouse, quail, turkeys and deer, with an occasional bear. We are working hard to save the game in this region from foxes, wildcats, game hogs and forest fires. We are gradually thinning out the animals named, but can find no defense against the fires that every spring sweep over these mountains. We should be glad to receive suggestions from experienced fire fighters as to the best way of preventing or limiting forest fires.

G. M. Sproul, McKeesport, Pa.

ON THE BATTENKILL.

Since the opening of the season, May 1, many good catches of trout have been made in the Battenkill and its tributary, Green river. My friend, Charles Hawley, and I could hardly wait for the day to arrive, and we planned to be the first on the river. When I was called at 3 a.m., I tumbled sleepily out of bed, and going to the window, found it was pitch dark, cold, and the wind blowing a gale. It was still dark when we reached the river, and growing colder every minute.

Someone had been before us, for we found the dying embers of a fire at the bridge. We afterward learned that a party had been fishing since midnight and had left just before our arrival. We stayed an hour until, discouraged by ill luck and the cold, we moved farther up the river. There Charley succeeded in enticing a sucker to land, and that revived our falling spirits. When presently I pulled in my line to see if my bait was frozen hard, a half pound trout came with it. After that the luck changed, and we returned at 6 o'clock with a good catch of trout.

Fishing has been better with the fly than with bait. Everyone thought fish would be scarce this year, as so many were taken last season, but the supply seems inexhaustible. I have heard some talk of nets and dynamite, and fear both are used occasionally.

C. H. Crofut, Arlington, Vt.

IS IT UP TO CUNNINGHAM?

I am warden of Comanche county and though I try to work with as little hurrah as possible, my district is the most law-abiding in Oklahoma. The farmer boys are coming over to my side, and there is little doing that they do not hear of. They put me on the track of a man named Horn, who had been dynamiting trout. I took out a warrant and found him just an hour after he had burst his last bomb. It tore off both his arms, broke 5 ribs, and blew out an eye. Rather than appear to be crowding the mourners, I omitted reading the warrant. It looked to me like a plain case of God and the little fishes.

But it is not all plain sailing. Newton Onwiler, owner of a restaurant here, served quail to his guests on Christmas. I dined with them. Then I took my information and the names of 6 witnesses to County Attorney S. M. Cunningham. He flatly refused to prosecute. If there is any way to bump him into doing his duty, I wish you would start the bumper. You may mention that you learned the facts from

Marion Miller, Lawton, Okla.

The EQUITABLE

HENRY B HYDE
FOUNDER.

J.W.ALEXANDER
PRESIDENT



J.H.HYDE
VICE PRESIDENT

THE SPAN

of life is uncertain – it may be long – or it may be short.

An adequate Endowment policy in the Equitable is a bridge on which you can cross safely over the waters of uncertainty to the solid ground of certainty.

If the span of your life is short, it protects your family. If your life is long it provides for your own mature years.

Opportunities for men of character to act as representatives
Apply to GAGE E. TARBELL, 2nd Vice President

For full information fill out this coupon or write

The Equitable Life Assurance Society of the United States

120 BROADWAY, NEW YORK

Dept. No. 16

Please send me information regarding an Endowment for \$.....

if issued at..... years of age.

Name.....

Address.....

AMATEUR PHOTOGRAPHY.

"For sport the lens is better than the gun."

I wish to make this department of the utmost use to amateurs. I shall, therefore, be glad to answer any questions and to print any items sent me by practical amateurs relating to their experience in photography.

THE ANNUAL COMPETITION

RECREATION has conducted 8 amateur photographic competitions, all of which have been eminently successful. The 9th opens April 1st, 1904, and will close November 30th, 1904.

Following is a list of prizes to be awarded:

First prize: A Long Focus Korona Camera, 5 x 7, made by the Gundlach Optical Co., Rochester, N. Y., fitted with a Turner-Reich Anastigmat Lens, and listed at \$85.

Second prize: A 4 x 5 Petite Century Camera, with Goerz Anastigmat Lens and Century Shutter, listed at \$73.

Third prize: A Royal Anastigmat Lens, 4 x 5, made by the Rochester Lens Co., Rochester, N. Y.; listed at \$36.

Fourth prize: A Waterproof Wall Tent, 12 x 16, made by Abercrombie & Fitch, New York, and listed at \$32.

Fifth prize: An Al-Vista-Panoramic Camera, made by the Multiscope and Film Co., Burlington, Wis., and listed at \$30.

Sixth prize: A No. 3 Focusing Weno Hawkeye Camera, made by the Blair Camera Co., Rochester, N. Y., and listed at \$27.50.

Seventh prize: A 12 x 12 Waterproof Wall Tent, listed at \$16.30.

Eighth prize: A Tourist Hawkeye Camera, 4 x 5, and made by the Blair Camera Co., Rochester, N. Y., and listed at \$15.

Ninth prize: A Bristol Steel Fishing Rod, made by the Horton Mfg. Co., Bristol, Conn., and listed at \$8.

Tenth prize: A pair of High Grade Skates, made by Barney & Berry, Springfield, Mass., and listed at \$6.

The 10 next best pictures will each be awarded a pair of chrome tanned leather driving or hunting gloves made by the Luther Glove Co., and listed at \$1.50.

The 10 next best pictures will each be awarded a Laughlin Fountain Pen, listed at \$1.

A special prize: A Goerz Binocular Field Glass, listed at \$74.25, will be given for the best picture of a live wild animal.

Subjects are limited to wild animals, birds, fishes, camp scenes, and to figures or groups of persons, or animals, representing in a truthful manner shooting, fishing, amateur photography, bicycling, sailing or other form of outdoor or indoor sport or recreation. Awards to be made by 3 judges, none of whom shall be competitors.

Conditions: Contestants must submit 2 mounted prints, either silver, bromide, platinum or carbon, of each subject, which, as well as the negative, shall become the property of RECREATION. Negatives not to be sent unless called for.

In submitting pictures, please write simply your full name and address on the back of each, and number such prints as you may send, 1, 2, 3, etc. Then in a letter ad-

ressed Photographic Editor, RECREATION, say, for instance:

No. 1 is entitled — — —.

Made with a — — — camera.
— — — lens.

On a — — — plate.

Printed on — — — paper.

Length of exposure, — — —.

Then add any further information you may deem of interest to the judges, or to other amateur photographers. Same as to Nos. 2, 3, etc.

This is necessary in order to save postage. In all cases where more than the name and address of the sender and serial number of picture are written on the back of prints I am required to pay letter postage here. I have paid as high as \$2.50 on a single package of a dozen pictures, in addition to that prepaid by the sender, on account of too much writing on the prints.

Any number of subjects may be submitted.

Pictures that may have been published elsewhere, or that may have been entered in any other competition, not available. No entry fee charged.

Don't let people who pose for you look at the camera. Occupy them in some other way. Many otherwise fine pictures have failed to win in the former competitions because the makers did not heed this warning.

ENLARGING.

Since reading Mr. Klinefelt's inquiry in January RECREATION in regard to using a 5 x 7 long focus Premo camera for making bromide enlargements, I have been giving the matter some thought.

I have such a camera, which I use for the most of my work; but I do not consider it ideal for the purpose named. It can be used, though if Mr. K. can get hold of a front focus, reversible back view camera he will find it more satisfactory.

The first requirement for enlarging is a room which can be made entirely dark. Bromide paper is nearly as light-sensitive as a day plate, and must be worked by yellow light. The easiest way to darken the windows of the room selected is to make a light wooden frame for each one, using pine strips, say $1\frac{1}{2} \times \frac{7}{8}$ inches. These frames are to fit snugly inside the window casing and are halved together at the corners. Cover each side with heavy brown paper glued on. If the windows are large one or 2 cross bars should be put in the frames to stiffen them. The frames may be held in place in the windows by a screw at top and bottom, or by buttons, as may be most convenient, the object being to get as close a joint as possible around the edges. If some light filters through the

paper give it a coat of lampblack and turpentine, with a little varnish added to make the mixture adhere to the paper. There will probably be some cracks around the edges of these screens which will admit light. To cover these get some cheap black cambric and make curtains for the windows, which may be hung from small nails at the top of the casing.

One of the windows in the room should have a clear outlook to the sky. The frame for this window should be made stiffer and heavier than the others, and at a convenient height from the floor 2 cross bars should be put in, leaving about $5\frac{1}{2}$ inches between their inner edges. To the lower one of these attach a board projecting out into the room so that the camera may set on it with its rear end close against the screen frame.

Next make out of 3-16 inch wood a box about 2 inches deep, without top or bottom. This must fit closely inside the back frame of the camera in the space occupied by the ground glass frame, which is removed when the camera is to be used for enlarging.

The rear end of the little box is to be secured to the 2 cross bars of the window frame and its inside provided with small cleats to hold the negative in a position parallel to the back of the camera. The sides of the box may be slotted so that the negative may be pushed into place from the outside. The minor details of this I leave to the builder, as they must vary according to circumstances.

This window frame is to be covered with paper like the others, taking special care that all cracks are covered. A rectangular opening should be left where the box is attached so that the light may strike the negative. This opening should be covered with a piece of ground glass or tracing cloth to diffuse the light.

As a support for the bromide paper take a fair sized box, the ever present soap box suggesting itself here, and nail 2 uprights to its sides. To the upper end of these fasten a small drawing board or something similar, so that its flat side is parallel to the window. The center of this board should be at the same height as the lens when the camera is in position on its shelf. This board should be covered with smooth white paper pasted on, to make a good surface on which to focus.

Bore a hole in a small square piece of $\frac{1}{2}$ inch wood, which will fit easily over the end of your lens, and over this hole fasten a square of yellow glass.

To make an enlargement, darken all the windows and put the camera in position. Slip the chosen negative into place in the box, inverted, and with the film side next the camera. Place the soap box easel in

position in front of the lens. A heavy stone or a flatiron in the box will help to hold it steady. By shifting the relative positions of lens and easel you will be able to get any degree of enlargement. Use the lens wide open for focussing and when a sharp focus has been obtained stop down to say F-16.

Slip the yellow glass cap over the lens and pin a small strip of bromide paper on the easel. Remove the lens cap for say 30 seconds. Cap the lens and develop the test strip.

Bromide paper is somewhat slower in development than gaslight paper (velox, rotox, etc.), but still much faster than a dry plate.

If your test strip shows a correct exposure you may proceed to pin a full sized sheet on the easel and expose as before. The object of the yellow glass cap is now apparent, for it allows enough light to pass to permit of accurate adjustment of the paper without risk of fogging it. Thin parts may be held back by shielding with a card during part of the exposure and conversely over dense spots may be brought out by giving them extra exposure by means of a cardboard shield with a hole cut in it which is held over the dense part, gently moving it so as to avoid making a sharp line on the print.

Any of the various brands of bromide paper on the market will give good results. The Eastman Kodak Co. makes paper that is reliable in every respect. The hard, or slower working, grade will prove the best for general use.

Amidol or M-2 developer will prove satisfactory, and I prefer an acid fixed bath, such as is recommended by the makers of gaslight paper.

Japanned iron trays are the most satisfactory for this work. They are light, their cost is small compared with trays made of other materials, and with an occasional coat of bicycle enamel or asphalt varnish they will last a long time.

If at any time more detailed information is desired I shall be glad to give what help I can, either through RECREATION or by personal letter.

C. M. Whitney, Bayonne, N. J.

A NEW SPORT.

D'LAURIE.

How many of RECREATION's readers are egg collectors? Some, I am sure. To them I propose a new and exciting sport, a game in which both they and the birds will be winners; for while they will get nests and eggs, the birds will yet retain them. This sport is made possible by the camera.

My interest in bird photography dates

many years back. My first success was a photo of 3 fuzzy, funny little ground sparrows that had their home under a sheltering bank. As I was focusing, one, more restless than its fellows, fluttered out, and had gone some distance before I caught him and brought him back. I remember yet my thrill of pleasure when I developed the plate and saw the image grow.

All is not so easy, however, for I have been 2 years attempting to get a good photo of a pewee's nest under a certain bridge. A picture of a wood pewee's nest, secured after days of hard work, is one of my prized possessions. The nest was built on the branch of an oak fully 60 feet above the ground. The only way to get it was to crawl out on a limb higher up. After several failures, I one day strapped my camera to my back, climbed the tree and crawled out on the limb to within 20 feet of the nest. The creaking and swaying of the limb forbade further progress, and I was compelled to take the nest at that distance. Holding to the branch with arms and legs, I focused as best I could and snapped. The picture, though small, proved excellent.

The most peculiar nest, of which I have a picture, a pyramid of sticks with 2 blue eggs a-top, was built by an ambitious black billed cuckoo in an old lard can chance-thrown into a thicket.

I have, too, a photo of a cowbird's nest that caused some mystification until it turned out to be a thrush's home.

The swinging cradle of the red eyed vireo, the more stable one of his yellow throated cousin, the tiny nest of a humming bird with its tiny eggs, the high-set homes of hawks and crows, and many more have place in my collection, and it is a pleasure to look them over and recall the history of their getting.

Come, my friends! put away your collecting boxes, drills, and blow pipes, and like true sportsmen preserve the birds. Give this new sport a fair trial. Don't give up after the first failure, stick at it. Think of the trees you have shinned after crow's eggs, only to find the nest was last year's! Stick to it! and you will find health and pleasure in this novel pastime; the birds will enjoy their share of life, and we shall not have to regret another extinct species.

I feel sure that, should sufficient interest be aroused, the editor of RECREATION would have a class for these photographs in his next contest, and award a prize to the most worthy.

I use a Premo 5 x 7 camera, made by the Rochester Optical and Camera Co., and fitted with a Victor rectilinear lens. I generally use a 128 stop with an exposure of 40 to 60 seconds; this, of course, depends

on circumstances. Develop with hydro, and print on Velox paper.

O. L. Griffith, Rosemont, Pa.

SOUVENIR POST CARDS.

The ease with which these cards are made leads me to wonder why the amateur photographer does not get busy. The card may be bought already sensitized. All that is necessary may be found in the possession of every amateur. The most important item is the negative. It should be rich in detail and have some contrast. A piece of black paper, 4 x 6 inches, with an opening cut the size one wishes the photograph to appear on the card, is the only need. Cut the opening $2\frac{3}{8} \times 3\frac{3}{8}$; then place a regular size post card on the paper, marking with a heavy line the position the sensitized card is to occupy. This will leave a narrow white margin on 3 sides of the photo and $1\frac{5}{8}$ inches to write on. Instead of the severe corners, I cut a lantern slide mat in 4 and paste them on the mat, making round corners. These cards are greatly appreciated by the persons who receive them. A bit of landscape or a spot where once we took our lunch makes a valued souvenir. I use Rotox cards and find them perfect.

C., Bethlehem, Pa.

I have been having very thin negatives, though this does not seem to be caused by under development or exposure. Some of my negatives are so thin that the sky in the negative prints gray. There is plenty of detail, but it has a faded brown appearance. If I hold my hand back of the sky part of the negative, I can easily see my hand right through the sky. It is mysterious to me, and I hope you can solve it for me.

Frank Rose, East Boston, Mass.

ANSWER.

I am inclined to believe that the cause is over exposure. I suggest making at least 3 different exposures, and developing each one separately just as you have been doing.

An over exposed plate is thin, flat, lacking contrast, full of detail, but producing a gray print. An under exposed plate has a lack of detail, and if not developed too far produces a gray print. If development is carried far, the print will show great contrast, but not much detail.—EDITOR.

Please give us all you can on photography. I get more practical hints from RECREATION than from a magazine to which I subscribed that is devoted entirely to that subject.

W. H. Cummings, N. Y. City.



"THE CORRESPONDENT."

DRAWN FOR THE EASTMAN KODAK CO BY FREDERIC REMINGTON THROUGH COURTESY COLLIER'S WEEKLY. COPYRIGHT 1904 BY COLLIER'S WEEKLY.

In war as in peace
THE KODAK
 is at the front.

In Cuba and the Philippines, in South Africa, in Venezuela, and now in Korea and Manchuria, the camera most in evidence is the Kodak.

The same qualities that make it indispensable to the correspondent make it most desirable for the tourist—simplicity, freedom from dark room bother, lightness combined with a strength that resists the wear and tear of travel.

Catalogue free at the dealers or by mail.

Take a Kodak to St. Louis. No charge for admission of 4 x 5 (or smaller) Kodaks to the Exposition.

EASTMAN KODAK CO., Rochester, N. Y.

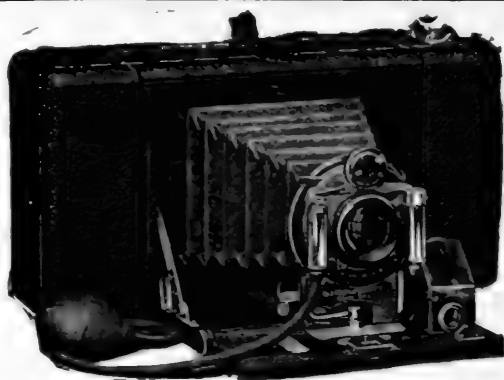

COMBINATION HAWK-EYE

A New Film Camera which allows the operator to focus on ground glass.

May also be used with glass plates.

Fitted with Extra Rapid Rectilinear lens, B. & L. Automatic Shutter, rising and falling front controlled by rack and pinion.

No. 3 Combination Hawk-Eye, pictures $3\frac{1}{4} \times 4\frac{1}{4}$, equipped for film and plates, . . \$27.50

BLAIR CAMERA COMPANY,
ROCHESTER, N. Y.

Send for Catalogue.



Do you want a Good, Reliable,
Substantial, Well Made

Single Barrel Shot Gun

If so, send me

10 YEARLY SUBSCRIPTIONS

and I will send you such a
Gun as a premium

It is made by the *DAVENPORT ARMS CO.*, and this means it is made of good material and that only good workmanship is put on it.

This is one of the many remarkable opportunities *RECREATION* is offering to men and boys to fit themselves out completely for shooting and fishing.

Sample Copies for Use in Canvassing
Furnished on Application.

Address

RECREATION

23 W. 24th St., New York City.

A few days since there came to my hand the slickest, nicest, dandiest fishing rod ever likely to fall into the hands of any angler, a Bristol steel rod, light and dainty enough to pack in a ladies' traveling outfit. Words fail wherewith to express my thanks for the beautiful favor received for getting up a club of 5 subscribers to *RECREATION*. Let other readers of this spicy little magazine go and do likewise.

E. R. Cox, Tioga Center, N. Y.

I most heartily commend the stand you have taken in your war on the game hogs. I believe you are justified in being as harsh as you are toward game slaughterers. Keep up your good work; success is sure to follow.

Edward Murray, New York City.

I take this opportunity to say you may feel very proud of *RECREATION* for February. It is fine, wonderfully interesting, and beautifully illustrated. The subscription price should be double what it is.

Dr. R. B. Maury, Memphis, Tenn.

I received my premium, the Savage 22 rifle. A thousand thanks! It's the finest rifle I ever handled. My friends are overjoyed and are glad to have helped me get it.
Chas. Vitous, Chicago, Ill.

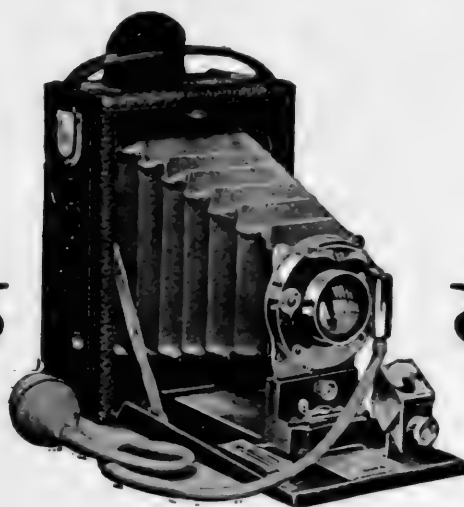

WITH THE

Folding Film PREMO

and a pocket full of FILM PACKS
you're ready for a whole summer's photography

The Folding Film Premo is pocket size. Fitted with lens and shutter capable of the highest quality of work. It loads in three seconds by daylight for 12 exposures. The $3\frac{1}{4} \times 5\frac{1}{2}$ size is particularly adapted to post card pictures.

PREMO FOLDING FILM	$3\frac{1}{4} \times 4\frac{1}{4}$	$3\frac{1}{4} \times 5\frac{1}{2}$	4 x 5
CAMERA, No. 1	\$10.00	\$12.50	\$12.50
PREMO FILM PACK, 12 Exposures,	.70	.80	.90

*Premo Plate Cameras become film cameras by use of the Premo
Film Pack Adapter.*

PREMO FILM PACK ADAPTER, $3\frac{1}{2} \times 4\frac{1}{2}$, \$1.00, 4 x 5, \$1.50

CATALOGUE AT DEALERS OR BY MAIL
Mention RECREATION.

ROCHESTER OPTICAL CO.
ROCHESTER, NEW YORK

**DO YOU WANT A
FOLDING
CANVAS BOAT?**

If So, Send Me

**35 Yearly Subscriptions to
RECREATION**

AND I WILL SEND YOU

A 14 ft. King Folding Canvas Boat

LISTED AT \$48

capable of carrying 2 men and an ordinary camp outfit. There are thousands of these boats in use, and nearly every man who is using one of them praises it on every occasion.

Sample copies of RECREATION for use in canvassing will be furnished on application.

Address 23 West 24th St., New York

It's Not a Toss-Up



as to the quality of pictures made with a

KORONA Camera



GUNDLACH-MANHATTAN OPTICAL CO., 730 So. Clinton Ave., Rochester, N.Y.

YOU CANNOT BUY A

KORONA CAMERA

from the Photographic Dealer nowadays because the
P H O T O G R A P H I C T R U S T

prohibits it, in effect, by making him forfeit a large part of his profit on *their* goods, if he dares to buy and sell *ours*.

If your dealer is one of these, or if no dealer in your town handles our products, **we'll let you keep the profit the dealer formerly made.**

Write for catalogue and discounts. This is an unprecedented opportunity to buy the peerless **KORONA CAMERA** at wholesale price. We manufacture also **BINOCULARS, TELESCOPES, MICROSCOPES** and other optical goods

Gundlach-Manhattan Optical Co.

730 South Clinton Avenue, Rochester, N. Y.

Mention RECREATION.

SLEEP

IS TIRED NATURE'S
SWEET RESTORER

After a hard day's tramp, you must have

A Good Night's Rest

in order to fit you for the next day's work. Better to sleep on a good bed without your dinner, than sip at a banquet and then sleep on the cold, hard, wet ground. You can get

A Recreation Camp Mattress

of rubber, with valve for inflating, made by the Pneumatic Mattress Co., and listed at \$18.

For 10 Yearly Subscriptions to
RECREATION

Send for Sample Copies

Address RECREATION, 23 West 24th Street, New York.



Send home vacation pictures on

VELOX Post Cards.

You can print them in your room at the hotel. No dark-room necessary.

Velox Post Cards can now be had in the new Velvet Velox surface.



ALL DEALERS.

NEPERA DIVISION,
EASTMAN KODAK CO.,
Rochester, N. Y.

"If you please, sir?"

"Well, Jimmy?"

"Me grandmother, sir"—

"Aha, your grandmother! Go on, Jimmy."

"Me grandmother an' me mother"—

"What? and your mother, too! Both very ill, eh?"

"No, sir. Me grandmother an' me mother are goin' to the baseball game this afternoon an' they want me to stay home an' take care of me little brudder."—Cleveland Plain Dealer.

RECREATION is the best and most interesting of its kind.

S. D. McDaniel, Colorado Springs, Colo.



Your Camera is only as good as your lens

Bausch & Lomb Plastigmat Lens

With Volute Shutters makes a cheap camera good and an expensive one perfect. Ask your dealer to order it for you when buying your camera. Catalogue of Lenses, Shutters, Field Glasses, Microscopes on request.

BAUSCH & LOMB OPTICAL CO.

ROCHESTER, N. Y.
NEW YORK BOSTON CHICAGO

Something Special. A Fine Casting Minnow Free: To each person sending me \$1 for one new yearly subscription to RECREATION, or sending it direct to be placed to my credit, I will forward, all charges prepaid, a finely finished wooden casting minnow. This minnow has the latest improved spinner which will not catch upon the weeds; is finished with silver belly and green back, has three treble hooks, is weighted so it will not twist the line, always keeps right side up when in the water, and is just the right weight for casting. Lloyd J. Tooley, 141 Burr Oak Street, Kalamazoo, Mich.

For Golf & Tennis Players

"PRESTO! - CHANGE!"

ATTACHABLE EYEGLASS TEMPLES



Eye Glasses into Spectacles. Spectacles into Eye Glasses

BE PROTECTED!

DON'T BREAK OR LOSE YOUR GLASSES IN EXERCISE, WIND AND STORM

Can be attached by anyone

Send thickness of lens when ordering by mail

Price in Nickel 50c. a pair.
Established 1842

Gold 75c. a pair.

Gold Filled \$1 a pair.

Solid Gold \$2.50 a pair.
Send for Circular

GALL & LEMBKE, Dept. C, 1 W. 42d St.

21 Union Sq., New York



GLASSES WITHOUT TEMPLES
PATENTED
July 17, 1902



GLASSES WITH TEMPLES
Patented by
Furgit & Pappas



The reputation, skill and accuracy which stand behind the Goerz lens are offered with the "Sector" Shutter.

"It's a Goerz Product"

The mechanism of the "Sector" Shutter is beautifully simple yet combines those necessary qualities which will be appreciated by all photographers. We want you to know all about the "Sector." Send your name and address and an interesting booklet will be mailed free by return mail.

C. P. GOERZ,

Room 27 52 E. Union Square, - - - New York City

Some time ago I sent you 50 subscriptions in 2 instalments and received a handsome gun cabinet made by the West End Furniture Co., Williamsport, Pa., which was fully and gratefully appreciated by myself and my family.

Julius C. Low, Philadelphia, Pa.

I must thank you for the prompt way in which you shipped the Kenwood bag and the Bristol rod. The bag is the best I have ever seen and the Bristol—well, anyone knows the quality.

H. B. Floyd, Washington, D. C.

RECREATION is the best sportsmen's paper published.

Leslie Kimcaid, Syracuse, N. Y.

OIL PORTRAITS ON APPROVAL

If you will send me a photo of yourself or a friend and state color of hair, eyes and complexion, I will paint and send you on approval an oil or pastel portrait, miniature or life size.

Canvas, 6x8 or 8x10 inches, **\$10**

Canvas 10x12 or 12x14 inches, **\$15**

Three-quarters life size, - - **\$25**

Full life size, - - - - - **\$35**

Z. EMMONS, 58 West 104th Street

Reference: Mr. G. O. Shields.

New York

As a reader of RECREATION, I feel it my duty to express my gratitude to you for the grand work you are doing in ridding our country of the worst pest it ever had—the game hog. I thank you heartily for curing me of hoggishness.

R. C. McNeil, Pleasant Prairie, Wis.

The Harrington & Richardson single shot gun reached me promptly and in good order. It is the neatest and best finished single gun I ever saw.

Wm. L. Hemphill, Westchester, Pa.

I appreciate your magazine a great deal, and especially where you give it to the game hogs.

W. B. Ivey, Jacksonville, Fla.

LANTERN SLIDES COLORED SKILLFULLY AND ARTISTICALLY

FOR
Lecturers, Teachers and others

I refer by permission to the Editor of RECREATION

MRS. C. B. SMITH

**The Ansonia, 74th St., & Broadway,
New York City.**

LEST YOU FORGET, IN A FIT OF ABERRATION, I SAY
IT AGAIN, PLEASE MENTION RECREATION.

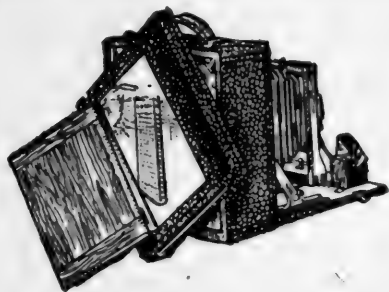

"Century" Cameras

Contain more real improvements, exclusive features and valuable adjustments than any others.

**Quicker to Manipulate—
Easier to Operate—
For both Plates and Film.**

Ask your dealer to show you our latest triumph—**The Revolving Back Century.**

All the New Models, from the dainty Petite to the king of all Cameras, the Century Grand, fully described in our 1904 Catalogue. Mailed free upon request.

CENTURY CAMERA CO., ROCHESTER, N. Y.

DO YOU WISH TO IMPROVE YOUR SHOOTING? IF IT IS AS GOOD AS IT CAN BE, DO YOU WISH TO KEEP IT SO? IN EITHER CASE, THE J. C. HAND TRAP WILL BRING WITHIN YOUR REACH THE FULL ADVANTAGE OF A SHOOTING RANGE. THESE TRAPS WILL SUCCESSFULLY THROW ANY OF THE CLAY TARGETS NOW IN USE, GIVING A LIFE LIKE REPRESENTATION OF A BIRD IN FLIGHT. I WILL SEND YOU A J. C. HAND TRAP FOR 5 YEARLY SUBSCRIPTIONS TO RECREATION. SEND IN YOUR CLUB NOW, AND IMPROVE ON YOUR SHOOTING.

OPINION

I always was conservative, { fuss,
And in this Eastern { scrap,
I'd have you know my sympathies
Are firmly with the { Russ.
Jap.
And when success shall crown his arms
Disgruntled folks may { yap.
cuss,
But as for me, I always said,
All hail the victor { Jap!
Russ!
—New York Sun.

THE DAYLIGHT DEVELOPER

No dark room required. One bath only.
Removes plates or flat films
directly from holder to

Solar - Develo.

TRADE MARK REGISTERED

then fix. Saves time and trouble. Lasts longer and does better work than any other. At all dealers, or 8-oz. bottle sent prepaid on receipt of 60c. Descriptive circular on request.

J. H. HOPPER & CO.

555 B West Broadway New York City

WILD ANIMALS THAT REFUSE TO ASSOCIATE WITH ME.

ARTHUR GUITERMAN.

In New York Times.

The Sentimental Panther met the Melancholy Lynx

In the mallows by the shallows where the Fawn at evening drinks.

Each was chewing on a Rabbit—

'Twas an absentminded habit,

For they're Brothers in the forest, from the Mooses to the Minks.

Quoth the Panther, "Lucivee,

How they libel you and me

With their pictures and their strictures on our 'predatory' lives!

Why! they even call us cruel!

Though we dine on water gruel

And we gambol and we ramble with our babies and our wives."

Sighed the Lynx, "I fear you're right.

Oh, they're dreadful impolite!

For they hint of blots of carnage on our stainless pantry shelves!

Come and join me in my den

With your pad and fountain pen;

For I'm sure they'll love us better when we've told about ourselves."

The Philanthropic Weasel and the Conscientious Fox

Bent in unremitting sorrow in a cavern in the rocks

O'er a wishbone and a bill

That were left them in the will

Of a friend—a lovely Rooster who had died—of chickenpox.

And the Weasel dropped a tear

As he murmured, "Reynard, dear,

How these Humans misinterpret all your motives pure and sweet!"

Sobbed the Fox, "That wicked slander

In the Matter of the Gander!

Who the Dickens wants their chickens!—with such loads of grass to eat!"

Now a Phonographic Marvel with a most convincing style

Overheard the Guileless Creatures, and he made it worth his while,

For he printed all they said;

And a Soulful Public read,

And it wailed, "The Beasts are Angels and our Kind alone is vile!"

But the Guide on Wolver's Run

Naughty! naughty!—owns a gun!

Conned these fancies and romances till he chuckled, lost in sin,

"Well, this may be mighty pretty

Fer old ladies in the City,

But I wonder where in thunder does the species 'MAN' come in?"

We have here ducks, reed birds, English snipe, etc., in their seasons.

Mrs. A. Creelman, Essington, Pa.

SKOOKUM SALMON.

An amusing incident happened during the early days, at an important ferrying place on Rogue river, in Oregon.

Pioneers and prospectors with their outfits were put across by Indians in their canoes, the saddle and pack animals being forced to swim.

Few Indians at that time possessed or understood firearms. On one occasion an extremely green young buck was making his first ferry. His passenger, a prospector, sat at the opposite end of the canoe, his carbine lying on the luggage piled between them.

At that ferry the river is deep, and the water so clear that the stony bottom may be distinctly seen. Glancing down, when the canoe was about the middle of the stream, the Indian saw an enormous salmon just beneath them. Shouting "Ugh! Skookum salmon!" he snatched the carbine, shoved it into the water and fired. There was no opportunity to ascertain the damage done the fish, for the contents of the canoe were immediately distributed over the ford. With the help of other ferriers, the miner and nearly all of his effects were rescued; but the Indian must have swum down to the shallows half a mile below, and crawled out on the rocks.

Some time later he reappeared on the opposite cliff, dejected and dripping, a great gash showing across one cheek. When hailed he cast a terrified glance toward the ferry, and with a loud "Ugh!" set off at a swinging trot up the trail. The startling experience must have inspired him with a wholesome awe for civilized appliances, as he was never again seen or heard of in that locality.

(Miss) M. L. Sutton, Coburg, Ore.

Two candidates for office were stumping the State, and in one town their appearance was almost simultaneous. The candidate last arriving stopped at a house for a drink of water. To the little girl who gave him the desired draught he offered in recompense some candy, and said,

"Did the man ahead of me give you anything?"

"Oh, yes, sir," she replied, "he gave me candy."

"Ah!" exclaimed the candidate, "here's 5 cents for you. I don't suppose he gave you any money?"

"Yes, he did. He gave me 10 cents!"

Not to be outdone, the candidate gave the little one another nickel, and, picking her up in his arms, kissed her.

"Did he kiss you, too?" he asked, genially.

"Indeed he did, sir!" she responded; "and he kissed ma, too!"—*Collier's Weekly*.

I have a pack of well trained hounds and I enjoy catching a bob cat or coon as much as killing a deer. We also catch a wolf once in a while.

Tom Coleman, Rosenberg, Tex.

POWERFUL FOOD

That can lift
A man
Out of
Bed

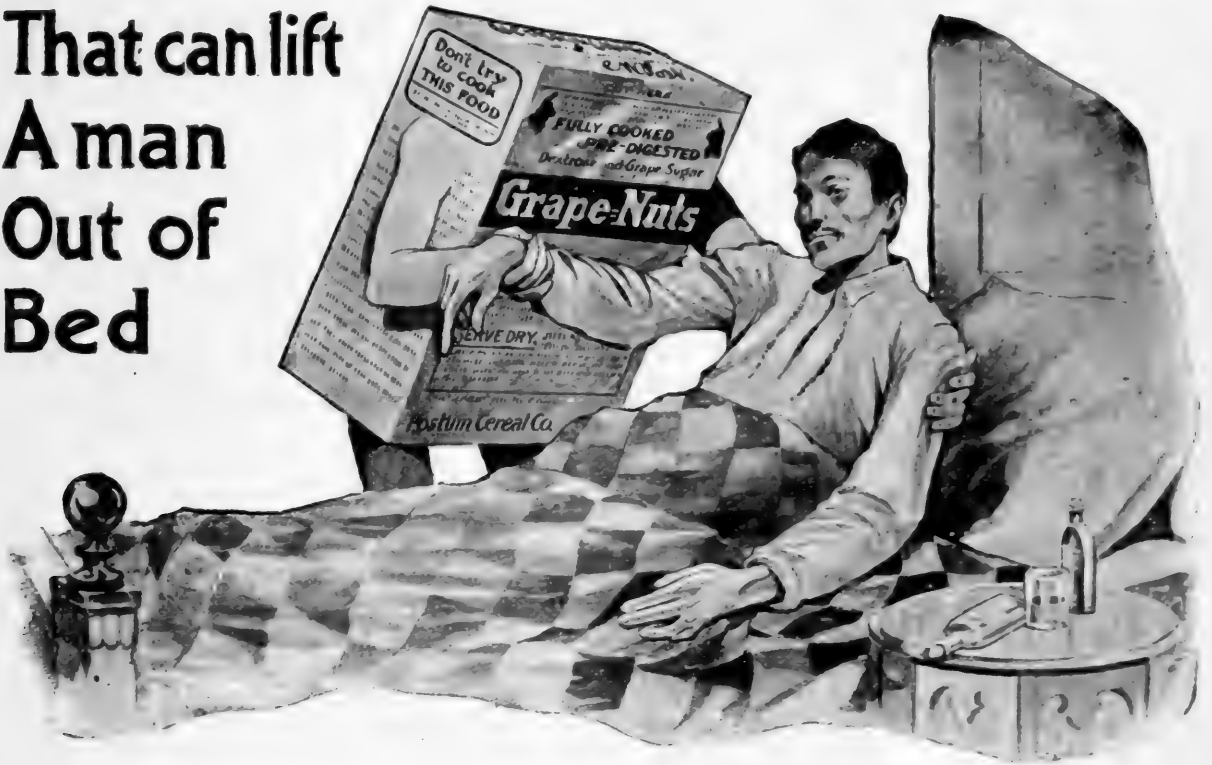

Disease cannot successfully attack people if their food and habits are right.

When one has stopped growing and lives mostly indoors it's high time to stop greasy meats or half cooked starchy food, much white bread, soggy vegetables, etc., etc.

It's worth trial to simplify the diet, get well and keep well.

Say Breakfast and Lunch on a little fruit (preferably cooked and very little sugar),

Dish of GRAPE-NUTS and Cream,
Slice of whole wheat bread and butter,
Cup of Postum Food Coffee,
One or two soft eggs and
NOTHING ELSE.

You are liable to "feel like a lord" in a day or two. "There's a reason." for GRAPE-NUTS food is a power for brain centres and body.

Have a try and tell yourself.

Get the little book, "The Road to Wellville," in each pkg.

HIGGINS & SEITER

Fine
China

Rich Cut
Glass



Flemish Punch Bowl No. 865

11 in. high, 13 in. opening, plain ivory figures, background, dark green and brown, \$5.65.

We illustrate our "**1/4 Less than Elsewhere**" policy by pricing this extra fine

Flemish Punch Bowl

(see illustration)

For thousands of other offerings equally attractive send for Catalogue No. 14 "U" having delicately tinted pictures of choice china. Free to all interested in purchasing.

West 21st and West 22d Streets
Near Sixth Avenue NEW YORK CITY

"Buy China and Glass Right"

Take good care of your hands

You may need
them next year

Send me
2 yearly subscriptions to **Recreation**
and I will send you
a pair of **Leather Hunting Gloves**
made to your measure, by the
Luther Glove Company
Berlin, Wisconsin

*Sample copies for use in canvassing
furnished on request*

Free:—To any person sending a new yearly subscription to RECREATION through me I will send a fine Nickel Folding Drinking Cup and Dog Whistle, listed at 60 cents, or a hard rubber, water proof Match Safe, listed at 50 cents, or a Canvas Belt with loops, listed at 60 cents, or a Revolver Leather Holster Belt, listed at 50 cents, or a choice of a Horn Whistle or Star Vest Pocket Whistle, or a Duck, Snipe, Turkey or Echo Call, each listed at 50 cents, or a Rifle Cleaning Rod, 22 or 32, with scratch and bristol brush, listed at 50 cents, or a choice of a Dandy, Star or Perfect Oiler, very fine and handy, and each guaranteed not to leak, listed at 50 cents each, or a Powder or Shot Measure, listed at 35 cents, or a coin Money Purse, genuine soft kid, three compartments, listed at 50 cents, or a Money Pouch, made of fine sheep skin, with draw string, very fine, listed at 75 cents, or a self-closing rubber Tobacco Pouch, listed at 50 cents, or a high grade French Brier Pipe, listed at 75 cents, or a Fountain Pen, listed at 75 cents, or a lightning Fish Scaler, or a spring lock Hook Shield, or a Spring Gun Cleaner, or a Rubber Hook Shield, or a Little Giant Small bore Rifle Cleaner.

Edward Jacobs, 227 Mulberry St., Coshoc-ton, O.

RECREATION is on top and I know it will stay there.

J. E. Bercaw, Dingman's Ferry, Pa.

AN EDITOR'S PERIL.

The editor stood at the case,
As printers were once used to stand,
With a cynical smile on his face
And a composing stick in his hand.

He gave his hot forehead a wipe,
All damp with the grime and the heat,
And put the reports into type
For readers of his little sheet.

"The Japs have forsaken Yalu,
They've gone up the opposite brink,
They're moving en masse on Wiju,
They'll soon fight a battle we think.

"The army has gone from Anju,
The march of the troops has begun,
The latest war news from Chifu
Shows the Russians to be on the run."

So he set up types. Of Kwang-su
And Anju and Wiju he told,
And Chifu and Yalu, Niu
Chwang and others enrolled.

Then in a few minutes he dropped
His stick and looked down at the case.
In puzzled confusion he stopped
Setting type with a frown on his face.

Then added this to his reports:
"We'd give yew some more of the news
If these names did not yews all the sorts,
We've yewsd every one of owr yews."
—J. A. Foley, in New York Times.

Received the Harrington & Richardson
revolver and am much pleased with it. It
is well worth the time I spent in getting
the subscribers. If RECREATION pleased
everyone as it does me, you would have no
trouble in getting every lover of nature to
subscribe. Carl Peavey, Howesville, Ind.

I received the Marble match box, and
am well pleased with it. That it is thor-
oughly waterproof I know, for I have given
it a severe test. I thank you heartily for
such a fine present, and will try to send
you more subscriptions.

Fred Beam, Smith River, Calif.

I received my premium, a pair of T. H.
Guthrie's horsehide hunting boots, and am
so well pleased that I enclose the extra
subscriber I received to date, gratis. May
success be yours.

Harry Stenanagel, Allegheny City, Pa.

I think more of your magazine every
month. Can hardly wait for it. I will try
and get you some new subscriptions soon,
and wish you success.

H. C. Stair, Greensburg, Pa.

I can not get along without RECREATION.
Please find enclosed \$1 to renew my sub-
scription.

V. N. Dyer, North Appleton, Me.

When You Use Beer In Your Home

In the cafe, or in the club, you ought
to buy the purest and best. Nothing
but the purest food product is fit for
the table of an American home.
The pure food experts agree that

Pabst Blue Ribbon

beer represents the choicest and most
palatable infusion of hops and malt
which the modern science of brewing
has produced. The Pabst malting process
takes twice as long as the old method,
but the product is a rich and mellow
brew of exquisite flavor. Add to this
the scrupulous cleanliness with which
it is brewed and you will see why
Pabst Blue Ribbon is the favorite
table beer in American homes. It is
made of choicest materials in a brew-
ery "as clean as a Dutch Kitchen."
Pabst Blue Ribbon is

The Beer
of Quality





H. J. TILLOTSON, M. D.
The Master Specialist of Chicago, who Cures Varicocele,
Hydrocele, and treats patients personally.
Established 1880.
(COPYRIGHTED)

permanent. My consultation will cost you nothing, and my charges for a perfect cure will be reasonable and not more than you will be willing to pay for the benefits conferred.

Certainty of Cure is what you want. I give a legal guaranty to cure or refund your money. What I have done for others I can do for you. I can cure you at home.

Correspondence Confidential. One personal visit at my office is preferred, but if it is impossible for you to call, write me your condition fully, and you will receive in plain envelope a scientific and honest opinion of your case, Free of charge. **My home treatment is successful.** My books and lectures mailed free upon application.

H. J. TILLOTSON, M.D., 140 Tillotson Bldg, 84 Dearborn St., CHICAGO

Varicocele Hydrocele

**Cured to Stay Cured in 5 Days.
No Cutting or Pain. Guaranteed
Cure or Money Refunded.**

VARICOCELE. Under my treatment this insidious disease rapidly disappears. Pain ceases almost instantly. The stagnant blood is driven from the dilated veins and all soreness and swelling subsides. Every indication of Varicocele vanishes and in its stead comes the pleasure of perfect health. Many ailments are reflex, originating from other diseases. For instance, innumerable blood and nervous diseases result from poisonous taints in the system. Varicocele and Hydrocele, if neglected will undermine physical strength, depress the mental faculties, derange the nervous system, and ultimately produce complicated results. In treating diseases of men I always cure the effect as well as the cause. I desire that every person afflicted with these or allied diseases write me so I can explain my method of cure, which is safe and permanent.

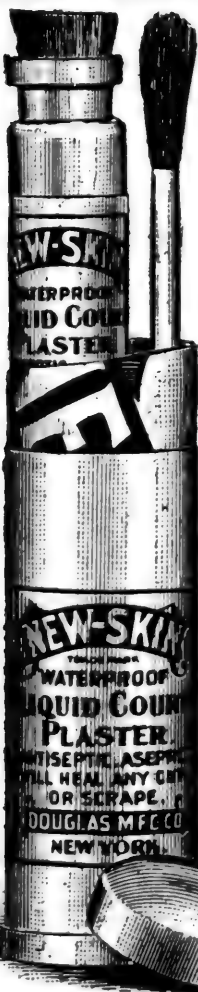

NEW-SKIN
TRADE MARK
REGISTERED
WATERPROOF

**LIQUID COURT
PLASTER**

Heals Cuts, Abrasions, Hang-Nails,
Chapped and Split Lips or Fingers,
Burns, Blisters, Etc. Instantly
Relieves Chilblains, Frosted
Ears, Stings of Insects,
Chafed or Blistered Feet,
Callous Spots, Etc., Etc.

A coating on the sensitive parts will protect the feet from being chafed or blistered by new or heavy shoes. Applied with a brush and immediately dries, forming a tough, transparent, colorless waterproof coating.

**Sportsmen, Motorists,
Golfers, Mechanics, Etc.**

are all liable to bruise, scratch or scrape their skin. "NEW-SKIN" will heal these injuries, will not wash off, and after it is applied the injury is forgotten, as "NEW-SKIN" makes a temporary new skin until the broken skin is healed under it.

EACH
Pocket Size (Size of Illustration), 10c.
Family Size, - - - - - 25c.
2 oz. Bottles (for Surgeons and
Hospitals), - - - - - 50c.

At the Druggists, or we will mail a package anywhere in the United States on receipt of price.

Douglas Mfg. Co.

96-102 Church St.
Dept. W, New York.

A year ago a manufacturer hired a boy. For months there was nothing noticeable about the boy except that he never took his eyes off the machine he was running. A few weeks ago the manufacturer looked up from his work to see the boy standing beside his desk.

"What do you want?" he asked.

"Want me pay raised."

"What are you getting?"

"T'ree dollars a week."

"Well, how much do you think you are worth?"

"Four dollars."

"You think so, do you?"

"Yessir, an' I've been t'inkin' so fer t'ree weeks, but I've been so blame busy I haven't had time to speak to you about it."

The boy got the "raise."—Frank Leslie's.

MENNEN'S BORATED TALCUM

TOILET POWDER

TRADE MARK

A Positive Relief For PRICKLY HEAT, CHAFING, and SUNBURN, and ALL AFFLICTIONS OF THE SKIN.

"A little higher in price, perhaps, than worthless substitutes, but a reason for it." Removes all odor of perspiration. Delightful after Shaving. Sold everywhere, or mailed on receipt of 25c. Get Mennen's (the original). Sample Free.

GERHARD MENNEN CO., Newark, N. J.

ALLEN'S FOOT-EASE

For Tired, Aching,
Smarting, Swollen Feet.



SHAKE
INTO YOUR
SHOES

Allen's Foot-Ease, a powder. It cures painful, smarting feet and ingrowing nails, and instantly takes the sting out of corns and bunions. It's the greatest comfort discovery of the age. Makes tight or new shoes easy. A certain cure for sweating, callous and hot, tired, aching feet. 30,000 testimonials. Sold by all Druggists and Shoe stores, 25c. *Don't accept a substitute.* Trial package FREE. Address,

Allen S. Olmsted Allen S. Olmsted,
Le Roy, N. Y.,
U. S. A.
Genuine bears above signature.

I learned to imitate the call of the wild duck from an article in August, 1900, RECREATION, and I wish to thank the writer who taught me how to give the call of the wild duck by means of the hands and lips. I can deceive the oldest duck-hunter, and have brought to bay black ducks too wily to come to trained live decoys.

T. J. Ardill, Wakefield, Mass.

The Chicago College of Dental Surgery

Founded in 1880. 2106 Graduates. Has continued under the management of its founders since its organization and offers unsurpassed facilities to dental students. For announcement address Dr. TRUMAN W. BROPHY, Dean, 775 W. Harrison St., Chicago.

“Face value” is
what you value your
face at. If rightly,
you use Williams’
Shaving Soap.

Williams’ Shaving Sticks and Tablets sold everywhere.
The J. B. Williams Co., Glastonbury, Conn.

How I Grew Tall

A Startling Story which will Interest
All who are short.

The Height of either Sex can quickly be increased from two to five inches. These marvelous results can be accomplished at home without the Knowledge of your most intimate friends.

The Free Book Tells You All About It.



MR. K. LEO MINGES.

Inventors, scientists and physicians have for years been trying to find some method whereby the height of an individual could be increased, and up to the last few years have met with failure. It remained for a comparatively young man, Mr. K. Leo Minges, by name, to discover what so many others had failed to do.

Mr. Minges resides in Rochester, N. Y., and has devoted the best part of his life in studying and experimenting on the Cartilage and his great efforts have at last been crowned with success. A large company composed of Rochester's leading citizens, has been formed for the purpose of placing Mr. Minges's discoveries and inventions before the public, so that now it is possible for any lady or gentleman who is short to increase her or his height from two to five inches. These results are absolutely guaranteed.

Mr. Minges has successfully used his method on himself, and has grown from a short, stunted boy to a handsome, robust man of six feet one inch in height. Thousands of people living in all parts of the world are using his method with equally startling results. Let us send you the absolute proof of the above statements. We have just issued a beautifully illustrated book, entitled “The Secret of How to Grow Tall,” which contains information that will surprise you. Ten thousand of these remarkable books will be given away absolutely free of charge in order to introduce them. If you fail to receive a copy, you will always regret it. This great book tells how Mr. Minges made his wonderful discovery. It tells how you can increase your height and build up the entire system. It contains the pictures and statements of many who have used this method. After you receive the book you will thank us the longest day you live for having placed within your reach this great opportunity.

Remember, a postal card will bring it to your very door, all charges prepaid. All correspondence strictly confidential, and sent in plain envelopes. If you wish a free copy of this book and the proof of our claims, write to-day. Address The Cartilage Co., Dept. 104H, Rochester, N. Y.

Bandmen Attention!

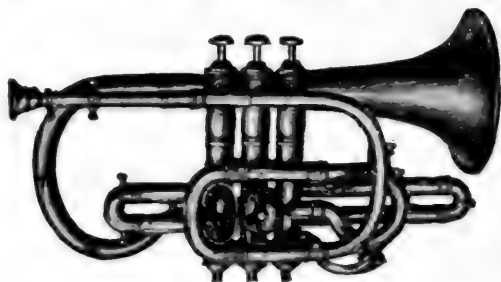

DO YOU KNOW

that we are selling high grade band instruments at prices one-third to one-half lower than other dealers can make you?

CORNETS from \$5.80 to \$23.95

and our splendid line of Imperial Band Instruments at prices 30 per cent lower than any other dealer can make.

SEND FOR OUR NEW SPECIAL BAND CATALOGUE

which illustrates a full line of drums, clarionets, flutes and saxophones, as well as our three large lines of brass instruments and fully explains how

WE ARE ABLE TO MAKE SUCH LOW PRICES.

Our booklet, "How to Buy Band Instruments" is full of valuable pointers. Send for it. It is free.

SEARS, ROEBUCK & Co.,
Dept. B2. CHICAGO.

A Fountain Pen

has become a necessity with every business man. You can get a

Laughlin Fountain Pen

*Made by the Laughlin Manufacturing Co.
Detroit, Michigan*

For 2 Yearly Subscriptions to RECREATION

And you can get these 2 subscriptions in 20 minutes, any day.

The Laughlin is one of the best pens in the market, and thousands of them are in daily use.

There is no reason why you should be without one.

**Sample Copies of RECREATION
for use in Canvassing
Furnished on Application**

A Kansas City teacher of a kindergarten was incapacitated from work one day last week by the following incident. The subject of the lecture and object lesson was animals and birds.

"Now, children," said the teacher, "I want each of you to think of some animal or bird and try for a moment to be like the particular one you are thinking about, and make the same kind of noises they are in the habit of making."

Instantly the schoolroom became a menagerie. Lions roaring, dogs barking, birds singing and twittering, cows lowing, calves bleating, cats meowing, etc., all in an uproar and excitement; all, with one exception.

In a remote corner a little fellow was sitting perfectly still, apparently indifferent and unmindful of all the rest. The teacher, observing him, approached and said,

"Waldo, why are you not taking part with the other-children?"

Waving her off with a deprecating hand and wide, rebuking eyes, he fervently whispered:

"Sh—sh—sh, teacher—sh! I'm a rooster, and I'm a-layin' a aig!"—Kansas City Star.

RECREATION is the magazine that lays over them all.

L. L. Henderson, Boston, Mass.



Vudor

TRADE MARK

Porch Shades

are made of Linden Fibre, in different colors to match the woodwork of your house, and in various sizes to fit your porch. They shut out the sun and at the same time let in the air, making the porch a cool, cozy and comfortable room on warm summer days. They screen the porch from the gaze of passers-by, while allowing you an unobstructed view. Very inexpensive.

Write today for our booklet, "Cosy Nooks"
Hough Shade Corporation, 24 McKey Blvd., Janesville, Wis.

WASHBURN



Lyon & Healy

Makers of the WASHBURN. The World's Largest Music House. Sells "Everything Known in Music."

Mandolins Guitars Banjos

Unequaled for Tone,
Durability
and Workmanship

We will gladly send free a beautiful Art Souvenir Catalogue and "Facts About the Mandolin" and "How to Play the Mandolin" if you will fill out this coupon and mail it to us.

46 Lyon & Healy, Chicago.

Please send me Art Souvenir Catalogue "Facts About the Mandolin" and "How to Play the Mandolin."

Name.....

St. Address.....

City..... State.....

"I'll bet you a dollar," said Blake, "that our 'Hello Girl' hears everything we say over the 'phone."

"How'll you prove it?" asked his partner.

"I'll show you," answered Blake.

"Number 483," he called. "Hello! hello! Is this you, Mary? Well, I just want to tell you that— Central, will you please stop listening!" he broke in, interrupting himself.

"I'm not listening," answered Central, indignantly.—Lippincott's Magazine.

RECREATION is the only sportsmen's magazine in the country.

N. A. Land, Cleveland, O.

I take off my hat to RECREATION as being the most interesting and best illustrated of any sportsmen's paper or magazine I have ever seen. Am sorry the game hogs were not so thoroughly roasted years ago. Here's wishing a long and successful life to the man who so persistently tries to reform the many biped swine.

R. H. Barger, Smith Centre, Kans.

Game is becoming scarce in this vicinity. We have some rabbits and a few quails. What prairie chickens we have migrate from the Northern part of the State. The farmers here protect the game by forbidding all trespassing with gun or dog.

James Warren, Atlantic, Ia.

Teddy's Knife



No. 34



HERE IS A KNIFE MEN LOVE so much they hate to throw an old handle away

THIS IS TEDDY'S CAMP KNIFE

No. 58. Cut is exact size; ebony handle, 3 blades, German silver ends. The long blade is for rough or fine work; the medium blade is as thin as a razor. Price, postpaid, \$1.00.

No. 31 we call "Our Masterpiece;" weighs only two ounces; 3 cutting blades; will cut a quill pen or an ax-handle; price, with ebony handle, postpaid, \$1.25; ivory, \$1.50; choicest pearl, \$2.00.

Our 3 blade Jack Knife sells at 75c.; our special price is 48c.; postpaid, 5 for \$2.00.

All our blades file-tested; warranted; replaced free if soft or flaky. Barbers' hollow ground Razor and Strop to suit, \$1.33.

Send for free 60-page list and "How to Use a Razor."

Maher & Grosh Co.
74 A St., Toledo, Ohio.

Do you want **A BOAT?**

If so, send me

**15 Yearly Subscriptions for
Recreation**

and get a

Mullins' Get There Ducking Boat

or send me 20 yearly subscriptions
for RECREATION and get a

Mullins' Bustle Ducking Boat

Sample Copies for use in canvassing
furnished on request, address

RECREATION

23 West 24th St., New York City

RUSTIC ARCHITECT AND BUILDER

Anything that can be built of natural wood

I build Rustic Work of all kinds from the best seasoned red cedar, including

Automobile Houses
(20 designs)

Log Cabins

Boat Houses

Bath Houses

Well Houses

Porches

Bird Houses

Horse Blocks

Roof Gardens

Fences

Bridges

Gateways

Chairs and Settles

Tree Seats

Summer Houses

Winerom Furniture

Vases

Flower Stands and

Lawn Furniture

of all kinds

Beer Gardens



No. 9.—RUSTIC SUMMERHOUSE (9 feet). Constructed of best red cedar, with or without seats; table built in center if desired; will stand the weather and last for years.

The larger work is built in sections for convenient shipment, and may be quickly set up by any one handy with tools.

I build from plans furnished, or will furnish plans with estimates. You will find my prices right, and the work of the very best. Representatives will call upon request.

Mention RECREATION.

SEND FOR ILLUSTRATED CATALOGUE
MY WORK SPEAKS FOR ITSELF

D. P. VAN GORDEN

Orange, N. J.

P. O. Box, 971.

Opposite D. & L. R. R. depot

A prominent educator in Philadelphia tells the following story on himself; In his early teaching days he had a position in a country schoolhouse in New England. The people in the neighborhood worked out their taxes by giving him board, and when there was no vacancy in the farmhouse he took a small room, while the neighbors supplied him with food. One day a young boy came running breathlessly toward him. "Say, teacher," he gasped, "my pa wants to know if you like pork?" "Indeed, I do like pork," the teacher replied, concluding that the very stingy father of this boy had determined to donate some pork to him. "You tell your father if there is anything in this world that I do like, it is pork." Some time transpired, and there was no pork forthcoming. One day he met the boy alone in the school yard. "Look here, John," he said, "how about that pork?" "Oh," replied the boy, "the pig got well."—Boston Beacon.

Black Squirrels:—Will send a pair of these rare and beautiful pets to any one who will send me 12 new yearly subscriptions to RECREATION. Will send a pair of Fox Squirrels for 6 new subscriptions, or a pair of Flying Squirrels for only 2 new subscriptions. Safe delivery of squirrels guaranteed to any part of U. S. or Canada. E. F. Pope, Colmesneil, Tex.

When you move take your house with you



This is dead easy in these days of portable houses. You can spend this summer on the sea shore, next summer in the mountains, the following summer in the Wilderness of Maine, and always have a good, substantial, portable house to live in. Easily taken down, cheaply transported, easily erected. Neat, cozy and inexpensive. Two men with a wrench, a few bolts and screws can take down or put up one of these houses in two hours.

Send for illustrated circular which tells the whole story, and mention RECREATION.

Springfield Moulding Works,

SPRINGFIELD, MASS.

Rare and Valuable Books

I have for sale a few bound copies of Vol. III of RECREATION, July to December, inclusive, 1895; also of Vols. IV and V, including the entire issues of 1896; Vols. VII, VIII, XII, XIII, XVI, XVII, XVIII and XIX. These are filled with interesting and valuable matter. The intervening volumes, are nearly all out of print, and can never be replaced at any time.

Vol. III sells at \$2

Vols. IV and V, one book, at \$3

All others \$2 each

Here are a few titles that will suggest the value of these rare books, to lovers of fields and sports:

The San Juan Islands.....	Maj. John Brooke, U.S.A.
The Lord Eagle of the Storm.....	Chief Simon Pokagon.
The Cowboy and the Wheel.....	James B. Adams.
Two Moose and Three Bear... ..	Dr. Hamilton Vreeland.
Hunting Big Game with a Camera.....	George Shiras, 3d.
The Fight on Soppa Creek.....	Capt. Wheeler, U.S.A.
My Best Shot.....	Hon. W. A. Richards, ex-Gov. of Wyo.
A Prairie Pastoral.....	E. L. Kellogg.
Woodcock on the Islands.....	F. W. G. Johnson.
Crossing the Rockies in '61.....	Major W. H. Schieffelin.
Salmon Fishing in Labrador.....	Col. Charles E. Fuller.
Coursing with Greyhound.....	L. F. Bartels.
A Bald-Faced Grizzly in Camp.....	M. W. Miner.
A Deer Drive with Spokane Indians.....	Lieut. W. R. Abercrombie.
Pheasant Shooting.....	Thomas G. Farrell.
Sitting Bull's Last Medicine.....	Margaret G. Brooks.
A Mountain Lion Hunt.....	Dr. Robert Meade Smith.
Trouting on Clark's Fork.....	Gen. F. W. Benteen, U.S.A.
A Youthful Guide and a Prize Bighorn.....	Hon. I. N. Hibbs.
The First Day of the Chicken Season.....	A. B. Cowie.
Goose Shooting in Colorado.....	W. E. King.
The Cowboy's Version of the Prodigal Son.....	Pony Bill.
Trouting on the Thunder.....	A. D. Curtis.
A Bad Grizzly.....	George W. Kellogg.
My Wife's Moose.....	W. E. Bemis.
How We Photographed the Wild Cat.....	Coyote Bill.
Elkland	Ernest Seton-Thompson.
Hunting Mountain Sheep in a Snowstorm.....	Capt. S. A. Lawson.
Grouse in New Hampshire.....	Old Bill.
Foxes in the Big Swamp.....	C. P. Franklin.
On the Chilkat Pass.....	H. L. Suydam.
A Rangeley Vacation.....	C. J. Halpen.
Pierre's Stratagem.....	H. D. Leadbetter.

There are many other stories in the books equally interesting. You should enrich your library at once by adding to it one of each of these rare volumes.

REMEDIES FOR MOSQUITO BITES.

As a mosquito bite exercises different effects on different persons, so the matter of counter-irritants, or applications to allay the pain, is also somewhat individual. For most persons, the application of a drop of strong ammonia water directly to the bite will stop or materially lessen the pain. It is the remedy I use, and it has been used by many others with equal success.

Eucalyptol has no effect in my case, but acts well with some persons.

Menthol is effective with many persons, and gives some relief in nearly all cases.

A drop of kerosene proves effective in some instances, but does not help me.

A bit of raw onion rubbed over the bite is almost as good as the ammonia in my case, and with such others as have tried it; but it is not so conveniently carried or applied.

The best method where the poisoning is not really severe is to let the bite alone and pay no mental attention to it. The cleanest and most effective repellent, that is, a material which will keep off mosquitoes, is oil of citronella. This is an extract from a grass, *Andropogon nardus*, primarily used in the manufacture of cheap grades of perfumery. The odor is not unpleasant to most persons, is lasting, and absolutely keeps off all kinds of mosquitoes.—Part of article by Prof. J. B. Smith, in New Jersey Experiment Station Report.

Avoid Wrinkles by Using

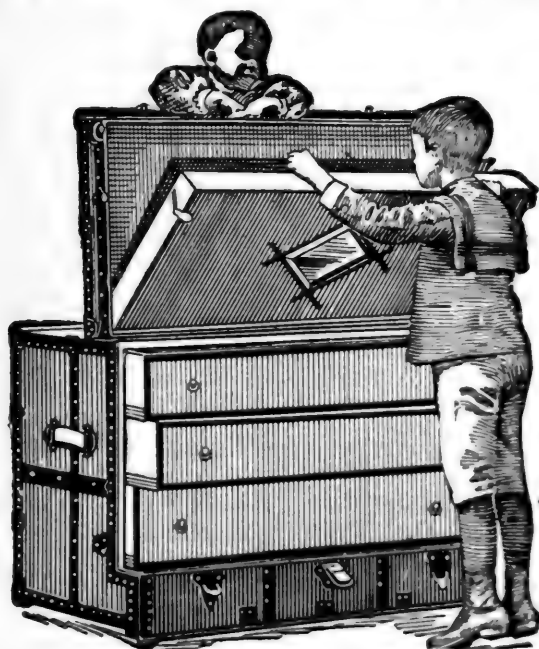

A Stallman Dresser Trunk

KEEPS YOUR CLOTHING
FLAT AND SMOOTH

Everything in reach. No heavy trays, but light, easy running drawers. Holds as much and costs no more than a good box trunk. Hand riveted, almost indestructible. Once tried, always recommended. Sent C. O. D., privilege examination. 2c stamp for catalogue. Mention RECREATION.

F. A. STALLMAN
87 W. Spring St. Columbus, O.

Office Men

**Work Easier
Keep Cooler** **Feel
Freer**

**"Lightweight"
President
SUSPENDERS**

are the lightest and smartest for Summer wear—2oz.
Guaranteed:—Satisfaction, a new pair or your money
back. 50c and \$1.00 any store, or by mail.

THE C. A. EDGARTON MFG. CO.
Box 811 Shirley, Mass.

Banner
Rubber
Coat

Pattern No. 28

Really Sheds Rain

Weight 4¾ lbs. Sent express paid in U. S. on receipt of \$5. Sizes 36 to 46 inches (breast); length 52 inches.

Give measure over ordinary coat.

RUBBER CAMP BLANKET

68x78 inches; flannel lined, \$2.75; (express paid if sent with coat or shoes).



BANNER

(TRADE MARK)

Hunting Shoes

Good quality ribbed rubber with top of best leather or water-proof wool lined brown duck. Excellent for wet grass, marsh or snow

Sent express paid in U. S. on receipt of \$3.50.

Northern Rubber Co. Box 336 St. Paul, Minn.

Are You an
Amateur
Photographer?



If so would you like a Camera
that will photograph

A whole range of mountains
A whole sweep of river
A whole army
A whole fleet of ships
A whole city

Or any other vast stretch of scenery or moving
objects? THE SWING LENS DOES IT

The **Al Vista**

is the thing. It lists at \$30

One of the greatest inventions of the age.
Given as a premium for 12 subscriptions.

For particulars address

RECREATION

23 West 24th Street

NEW YORK CITY

THE FOUR-TRACK NEWS

An Illustrated Magazine
of Travel and Education

MORE THAN 152 PAGES MONTHLY

Its scope and character are indicated by the following titles of articles that have appeared in recent issues; all profusely illustrated.

Among Golden Pagodas, - - - -	Kirk Munroe
Marblehead, - - - - -	M. Inlay Taylor
A Study in Shells, - - - - -	Dr. R. W. Shufeldt
Santo Domingo, - - - - -	Frederick A. Ober
Eleven Hours of Afternoon, - - - -	Cy Warman
A Gala Night on the Neckar, - - - -	Kathleen L. Greig
Echoes From Sleepy Hollow, - - - -	Minna Irving
Golf in the Rockies, - - - - -	Henry Russell Wray
In Barbara Freitchie's Town, - - - -	Thomas C. Harbaugh
Back of the Backwoods, - - - - -	Charles Howard Shinn
A Feast of Music, - - - - -	Jane W. Guthrie
Sailors' Snug Harbor, - - - - -	Bessie H. Dean
Since Betty Golfs—Poem, - - - - -	Josephine Wilhelm Hard
Niagara's Historic Environs, - - - -	Eben P. Dorr
In the Old Wood-Burner Days, - - - -	James O. Whittemore
The Land of Liberty and Legends, - - - -	Guy Morrison Walker
Nature's Treasure-house, - - - - -	Earl W. Mayo
Down the Golden Yukon, - - - - -	George Hyde Preston
Corral and Lasso, - - - - -	Minnie J. Reynolds
Little Histories:	
An Historic Derelict, - - - - -	Charlotte Philip
Where Lincoln Died, - - - - -	Alexander Porter
The Poets' Corner, - - - - -	Isabel R. Wallach
The Treason House, - - - - -	William Wait

SINGLE COPIES 5 CENTS, or 50 CENTS A YEAR

Can be had of newsdealers, or by addressing

GEORGE H. DANIELS, Publisher,

Room No. 48

7 East 42d Street, New York

New Guide Book

"In the Maine Woods"

PUBLISHED BY THE

Bangor & Aroostook Rail Road

AN artistically arranged publication of nearly 200 pages, descriptive of the fishing, camping, canoeing, hunting, etc., to be enjoyed in the great Northern Maine Woods. Over 100 beautiful illustrations, including several colored pages.

A welcome addition to any library.

Copy mailed for 10c in stamps.

Mention RECREATION.

C. C. BROWN, G. P. & T. A.
BANGOR, MAINE

A BEAUTIFUL SOUVENIR

ONE of the most exquisite things of the sort ever published is the **YELLOWSTONE PARK FLOWER BOOK** issued by the Northern Pacific Railway Company. It is a very dainty, immaculate piece of work, and contains one specimen, each of eleven varieties of

WILD FLOWERS

COMMON TO

YELLOWSTONE PARK

all carefully pressed and retaining perfectly their natural colors.

THE BOTANICAL and common name and habitat of each specimen are given.

THERE are also **six** full pages of half-tone illustrations of scenes in Yellowstone Park.

THE PAPER, printing, binding, illustrations and mounting of the flowers are all first class and the book is carefully mailed in corrugated card board.

THE PRICE of this book, which makes a beautiful souvenir, is **50 cents**, and it will be sent to any address on receipt of that amount in stamps, silver, postal note or express order by—

A. M. CLELAND,

ST. PAUL, MINN.

General Passenger Agent.

SEASHORE, LAKE *and* MOUNTAIN Resorts of EASTERN & NORTHERN NEW ENGLAND *and* the MARITIME PROVINCES

Reached by the

Boston AND Maine RAILROAD.

FOR ALL PUBLICATIONS APPLY TO
PASSENGER DEPARTMENT, B. & M. R. R.
BOSTON, MASS.

D. J. FLANDERS, Gen'l Pass & Ticket Agt.

Portfolios:

NEW ENGLAND
LAKES.

RIVERS OF
NEW ENGLAND.

MOUNTAINS OF
NEW ENGLAND

SEASHORE OF
NEW ENGLAND.

PICTURESQUE
NEW ENGLAND.
HISTORIC — MISCELLANEOUS

THE CHARLES RIVER
TO THE HUDSON.

Will be sent upon receipt of 6 cents
for each book.

*Illustrated
descriptive pamphlets
(containing complete maps)
have been issued
under the following titles,
and will be mailed
upon receipt of 2¢ in stamps
for each book.*

*All Along Shore
Lakes and Streams,
Fishing and Hunting,
Among the Mountains.*

*Southeast New Hampshire Merrimack Valley,
Southwest New Hampshire Lake Sunapee,
Valley of the Connecticut and Northern Vermont, Lake Memphremagog,
The Hoosac Country and Deerfield Valley,
The Monadnock Region,
Central Massachusetts.*

SUMMER TOURIST BOOK
GIVING LIST OF TOURS AND RATES, HOTEL AND BOARDING HOUSE LIST,
AND OTHER VALUABLE INFORMATION. FREE.

COLORED BIRD'S EYE VIEW from MT. WASHINGTON
COLORED BIRD'S EYE VIEW of LAKE WINNIPESAUKEE } SENT ON RECEIPT OF 6¢ FOR EACH.

ADIRONDACKS

CAMP MOHAWK and Cottages

Fourth Lake of the Fulton Chain. Patronized largely by families and parties of friends. Two handsome new cottages have been added which have very large rooms, fireplaces and baths. Write for booklet.

Mention RECREATION.

MRS. H. H. LONGSTAFF, Old Forge, N.Y.

I received the J. C. hand trap you sent as a premium. I was surprised to find that it throws targets as well as do traps costing 4 times as much. All who saw it work were pleased with it. I am delighted, but I fear I will not appreciate it enough, as it was so easily gotten.

W. H. Crabill, New Castle, Pa.

NORTHERN MICHIGAN Trout Fishing

Every fisherman wants to know where to catch Brook Trout.

The Grand Rapids & Indiana Railway (The Fishing Line)

issues an illustrated booklet which contains list of the best streams and lakes in Michigan. If interested send for

"Where To Go Fishing."

C. L. LOCKWOOD,

General Passenger Agent,

GRAND RAPIDS, MICH.



Send 2 cents for "Michigan in Summer," a book full of photographs of Northern Michigan Resorts.

The Buffalo Is Well Nigh Extinct

And every nature lover wants a relic of him. Here is a chance to get it:

I have in stock a limited number of buffalo horns, highly polished and fitted with nickel plated flanges at the base, so that they can be screwed on the wall, thus forming

A Novel and Effective Gun Rack

So long as the supply lasts I will give a pair of these horns for

3 Yearly Subscriptions to RECREATION

Sample copies for use in canvassing furnished on request. Address

Recreation, 23 W. 24th St., New York,



\$30

Colorado AND RETURN

From Chicago daily, June 1 to September 30, with correspondingly low rates from all points. A fine chance to visit this wonderful land of mountains, lakes and canons, of charming scenery and health-giving air, at a minimum of expenditure. The best route is via the

Chicago, Union Pacific and North-Western Line

Two superbly appointed fast trains daily over the only double-track railway between Chicago and the Missouri River. The Colorado Special, only one night to Denver from Chicago; two nights from the Atlantic seaboard.

NW271

The Best of Everything.

All agents sell tickets via this line.

Send 4 cents for booklets, maps and full information as to hotels, boarding houses, rates, train service, etc.

W. B. KNISKERN,
Passenger Traffic Manager C. & N.-W. Ry.,
CHICAGO.



F. S. MANNING

GOING into CAMP?

If so, you will need

A TENT

You can get one big enough for 4 men and their camp outfit, by sending me

8 Yearly Subscriptions to RECREATION

at \$1 each. You can get another tent big enough for 6 men by sending me

10 YEARLY SUBSCRIPTIONS

at \$1 each.

Why pay out money for a tent when you can make your friends pay for it?

Sail in and fit yourself for your summer vacation.

This is a great opportunity, and will hold good for only a few weeks.

Sample copies of RECREATION for use in canvassing furnished on application.

The Wild Game

has increased in numbers in the Northwest in recent years. It is estimated, for example, that during the hunting season of 1903, there were 10,000 deer killed in Northern Minnesota and this was a mere bagatelle in comparison with those remaining. The enforcement of effective game laws, principally, is responsible for this increase in wild animals.

The Northern Pacific railway traverses the very heart of the Northwest game fields and fishing waters. From Wisconsin to Puget Sound and the ocean the bass, pickerel, mescalonge, trout and salmon, and the deer, wolves, elk, mountain lions, mountain goats, etc., can be found within convenient distances of railway stations.

Those desiring to know more about this subject will find a chapter on it in "**Wonderland 1904**," published by the Northern Pacific and sent to any address for six cents by A. M. Cleland, the General Passenger Agent of the railway at St. Paul, Minn. The book has other articles of interest, is fully illustrated, and is a useful addition to the family library and reading table.



Vacation Days

Those who from experience know how much of pleasure is contributed to the vacation in the choice of a route select the

Lake Shore

& Michigan Southern Railway.

This is the road which reaches by its famous through trains, or by its direct connections, the entire resort country of the eastern, middle and western states, including Lake Chautauqua, south shore Lake Erie country, and its Islands, lake region in northern Indiana and southern Michigan, Colorado, Yellowstone country, St. Lawrence River, Adirondack and White Mountains, Atlantic Coast, etc.

Reduced rate tickets on sale June 1st to September 30th. All railways sell in connection with the Lake Shore.

Privileges—Enjoyable privileges accorded on tickets over Lake Shore—stop-over Lake Chautauqua, Niagara Falls, Lake Erie Islands, option of boat or rail between Cleveland and Buffalo, etc.

Summer Books—To assist in your vacation plans the following books will be sent by undersigned for eight cents in postage: "The Ideal Vacation Land," "Quiet Summer Retreats," "Lake Chautauqua," "Lake Shore Tours," "Travel Privileges," "Book of Trains."

A. J. SMITH, G. P. & T. A., Cleveland, O.

From "Macey" to You
Grand Rapids, Mich.

We save you from 25% to 40% on fine Office and Library Furniture. We manufacture the goods we sell. We guarantee quality and prices satisfactory.

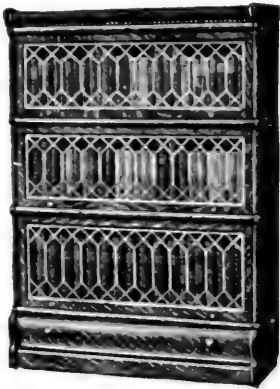

No. 10 H Office Desk
48 in. long by 30 in. wide; with file boxes and letter files complete as illustrated. Quarter-sawed oak front; balance of desk plain oak golden polish finish. Price **\$19.80**

Other roll top desks up to \$300.00. Ask for desk catalogue No. 2—mailed free.

Sectional Bookcase
49 in. high; 34 in. wide; 9 1/2 in. deep inside. Quarter sawed oak, art glass doors, drawer base, **\$18.25**
Plain glass, no drawer—\$13.50. Ask for catalogue No. 1—mailed free.

We prepay freight east of Mississippi River and north of Tennessee (points beyond on equal basis).

THE FRED MACEY CO., Ltd., GRAND RAPIDS, MICH.
Dept. LL3, 1300-1320 Division St.

AIR BRUSH



FOR ART WORK.

We are making and selling the best Art Tool in use. Applies color by jet of air, enabling the artist to do better work and save time. No studio complete without it. Circulars free. Mention **RECREATION**. Address

Air Brush Mfg. Co.
126 Nassau St., Rockford, Ill., U. S. A.

Thank you for the extra copies; it is a pleasure to hand such bits of grit, cheer and recreation to friends. Your whole magazine is as inspiring and refreshing as its name implies.

While traveling in the Dakotas last April, I saw a beautiful lot of ducks, geese, etc. How good it was to see them, and how I wished I could buy a tract of land out there, fence it hog tight, and induce the birds to stay inside during the open season. Or, better, put the hogs in there, in and out of season. That would give the fast disappearing game a chance to play a few more seasons on our lakes before the automatic gun blows them away forever. Rather than that this shameless slaughter should continue, I would wish for a law prohibiting the use on game of any gun throwing more than one shot at a discharge, and restricting shooters to certain low power shells in settled districts. It would save the game, and at the same time give a true sportsman his share by encouraging expert marksmanship.

F. V. Fremmer, Aredale, Ia.

I would not give **RECREATION** for any 2 of the other magazines I take.
W. L. Henderson, Bervie, Ont.

Sent on Approval

TO RESPONSIBLE PEOPLE

Laughlin

FOUNTAIN PEN

Guaranteed Finest Grade 14k. SOLID GOLD PEN.

To test the merits of **RECREATION**

as an advertising medium we offer your choice of

These Two Popular Styles For Only **\$1.00** Postpaid to any Address

(By registered mail, 8c. extra)

Holder is made of finest quality hard rubber, in four simple parts, fitted with very highest grade, large size 14k. gold pen, any flexibility desired—in feeding device perfect.

Either Style—**RICHLY GOLD MOUNTED** for presentation purposes, \$1.00 extra.

Grand Special Offer

You may try the pen a week; if you do not find it as represented, fully as fine a value as you can secure for three times the price in any other make, if not entirely satisfactory in every respect, return it and we will send you \$1.10 for it, the extra 10c. is for your trouble in writing us and to show our confidence in the Laughlin Pen—(Not one customer in 5,000 has asked for his money back.)

Lay this RECREATION Down and Write NOW.

Safety Pocket Pen Holder sent free of charge with each Pen

ADDRESS :

Laughlin Mfg. Co.

424 Griswold St., DETROIT, MICH.



It is Accident or Disease Only that puts Horse Hair on the Market

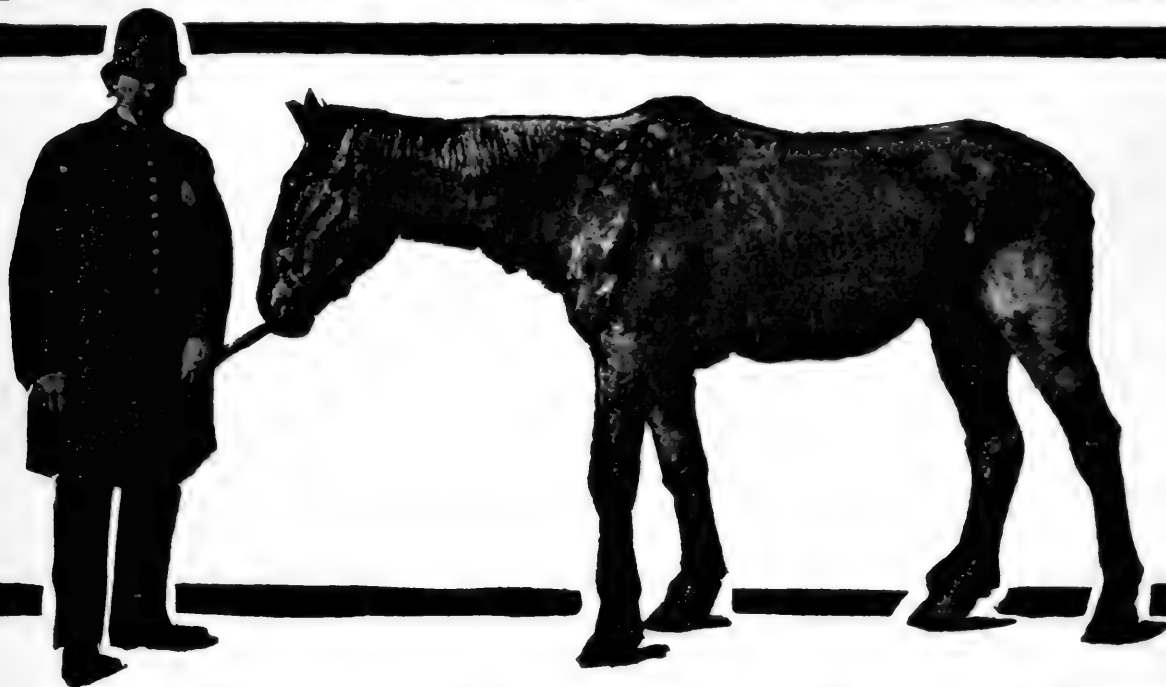

Not a Pleasant Thought to Dream Upon. Did You Sleep on a Hair Mattress Last Night?

Mr. N. PASHKOW is a mattress *renovator*, of Newark, N. J. He issues a circular booming his method and its necessity. He probably knows his business, and he says: "Hair is animal matter and is continually decaying. It is not healthy to sleep upon a mound of decayed animal matter"—all of which is very true. It explains why more than 200 people a day order an

Ostermoor Mattress \$15. Express Prepaid Anywhere

Each OSTERMOOR mattress is built—not stuffed. In all respects practically un-wear-out-able, retaining its shape and elasticity under all sorts of conditions and hard usage. Hand-laid sheets of

downy softness, each of the full size, are carefully compressed into the tick. The OSTERMOOR Patent Elastic Felt is purity itself, germ-free and vermin-proof. OSTERMOOR mattresses *cannot* get lumpy, never need renewing: an occasional sun-bath is all they require. The tick can be taken off and washed whenever soiled.

Send for Book, Mailed Free

Our 96-page book, "The Test of Time," not only treats exhaustively the mattress question, but also describes and illustrates (with scores of pictures), OSTERMOOR Cushions, Carriage Cushions, Church Cushions—we have cushioned 25,000 Churches. It is an encyclopædia of comfort and good taste—may we send it? Your name on a postal will do. It costs us 25 cents, but you are welcome to it—even if you send from curiosity alone.

Look Out! Dealers are trying to sell the "just as good kind." Ask to see the name "OSTERMOOR" and our trade-mark label, sewn on the end. Show them you can't and won't be fooled. It's not *Felt* if it's not an *Ostermoor*. Mattresses expressed, prepaid by us, same day check is received. Estimates on cushions and samples of coverings by return mail.

OSTERMOOR & COMPANY, 114 Elizabeth St., New York

Canadian Agency: The Alaska Feather and Down Co., Ltd., Montreal

30 Nights' FREE Trial

Sleep on the OSTERMOOR thirty nights free and if it is not even all you have hoped for, if you don't believe it to be the equal in cleanliness, durability and comfort of any \$50. hair mattress ever made, you can get your money back by return mail—"no questions asked."



SOME RARE OPPORTUNITIES

These goods are all new, and will be shipped direct from factory. Prices named are those at which manufacturers and dealers usually sell. Here is a good chance to get

A Book, a Gun, a Camera
 A Sleeping Bag, a Fishing Rod
 A Reel, a Tent, } FREE OF COST

Subscriptions need not all be sent at once. They may be sent in installments as taken and credit will be given on account. When the required number is obtained the premium earned will be shipped.

TO ANY PERSON SENDING ME

TWO new yearly subscriptions to **RECREATION** at \$1 each, I will send a copy of *Hunting in the Great West*, cloth; or an Ingersoll Watch or Cyclometer, listed at \$1; or a Recreation Waterproof Match Box, made by W. L. Marble and listed at 50c; or a Shakespeare Revolution Bait listed at 75c; or a Laughlin Fountain Pen; or a dozen Trout Flies, assorted, listed at \$1; or a pair of Attachable Eye-glass Temples, gold-plated, made by Gall & Lembke; or one Rifle Wick Plug, made by Hemm & Woodward, Sidney, Ohio, 30 caliber to 50 caliber, or Shotgun Wick Plug, 20 gauge up to 10 gauge; or a pair of chrome tanned horsehide hunting and driving gloves, listed at \$1.50, made by J. P. Luther Glove Co.

THREE new subscriptions at \$1 each, a safety pocket ax, made by W. L. Marble and listed at \$2.50; or a dozen Bass Flies, assorted, listed at \$2; or a pair of Shotgun Wick Plugs made by Hemm & Woodward, Sidney, Ohio, 20 gauge to 10 gauge; or a Polished Buffalo Horn Gun Rack, made by E. W. Stiles; or a pair of gauntlets, for hunting and driving, ladies' size, listed at \$2.50, made by J. P. Luther Glove Co., or a Press Button Jack Knife, made by The Novelty Knife Co., and listed at \$1.

FOUR new subscriptions at \$1 each, an Ideal Hunting Knife, made by W. L. Marble and listed at \$2.50; or a 32 caliber, automatic double action revolver, made by Harrington & Richardson Arms Co.

FIVE new subscriptions at \$1 each, a copy of *Cruisings in the Cascades*, cloth; or an Ideal Hunting Knife made by W. L. Marble, and listed at \$3; or a pair of lock lever skates, made by Barney & Berry, listed at \$4.50; or a J. C. Hand trap made by the Mitchell Mfg. Co., listed at \$4; or a Bristol Steel Fishing Rod, listed at \$6 or less.

SIX new subscriptions at \$1 each, a Hawkeye Refrigerating Basket made by the Burlington Basket Co., or one dozen Eureka golf balls listed at \$4; or a Pocket Poco B 3¼ x 4¼, made by the Rochester Optical Co., listed at \$9.

SEVEN new subscriptions at \$1 each, a copy of *The Big Game of North America*, or of *The American Book of the Dog*,

cloth, or one set Lakewood golf clubs, 5 in number, listing at \$5; or a series 11F Korona Camera, made by the Gundlach Optical Co., listed at \$10.

EIGHT new subscriptions at \$1 each. A series 1, 4 x 5 Korona Camera, made by the Gundlach Optical Co., listed at \$12, or an Acme single shot gun, made by the Davenport Arms Co., and listed at \$8.

TEN new subscriptions at \$1 each, a Cut-Glass Salad Bowl, made by Higgins & Seiter, and listed at \$4.50; or a Waterproof Wall Tent 7 x 7, made by Abercrombie & Fitch, and listed at \$8; or a Rough Rider rifle telescope, made by The Malcolm Rifle Sight Mfg. Co., and listed at \$12; or a Pneumatic Camp Mattress, listed at \$18; or a pair of Opera Glasses made by Gall & Lembke and listed at \$10.

TWELVE new subscriptions at \$1 each, a Davenport Ejector Gun, listed at \$10, or a Cycle Poco No. 3, 4 x 5, made by the Rochester Optical Co., listed at \$15.

FIFTEEN new subscriptions, \$1 each, a Shakespeare Reel, Silver Plated, listed at \$15; or a set of rabbit plates made by Higgins & Seiter, and listed at \$8; or a Field Glass made by Gall & Lembke; or a Kenwood Sleeping Bag, complete, with canvas cover, listed at \$16; or a Bulls-Eye rifle telescope, made by The Malcolm Rifle Sight Mfg. Co., and listed at \$16; or a pair of horsehide hunting boots, listed at \$10; or a Queen Hammock, made by the King Folding Canvas Boat Co., and listed at \$15; or a Mullins Duck Boat, listed at \$20.

TWENTY new subscriptions at \$1 each, a 14-karat Gold Hunting-case Watch, with Waltham Movement, listed at \$20; or an Elita single shot gun, made by the Davenport Arms Co., and listed at \$18; or an Acme Folding Canvas Boat, No. 1, Grade A, listed at \$27; or a Queen Hammock, made by the King Folding Canvas Boat Co., and listed at \$20; or a Mullins' Bustle Ducking Boat, listed at \$27.

TWENTY-FIVE new subscriptions at \$1 each, an 11-foot King Folding Canvas Boat, listed at \$38.

THIRTY new subscriptions at \$1 each, a Waterproof Tent, 14½ x 17, made by Abercrombie & Fitch, and listed at \$25.

THIRTY-FIVE new subscriptions at \$1 each, a 14-ft. King Folding Canvas Boat listed at \$48.

FORTY new subscriptions at \$1 each, a Savage .303 Repeating Rifle; or a No. 10 Gun Cabinet, made by the West End Furniture Co., and listed at \$32.

FIFTY new subscriptions at \$1 each, a No. 20 Gun Cabinet, made by the West End Furniture Co., and listed at \$38; or a Colt Automatic Pistol, made by the Colt's Patent Fire Arms Mfg. Co., and listed at \$25.

Address, **Recreation** 23 West 24th St. New York

THE Keeley Cure

**Alcohol,
Opium,
Tobacco
Using ***

Produce each a disease having definite pathology. The disease yields easily to the Treatment as administered at the following Keeley Institutes:

ALWAYS ADDRESS THE INSTITUTE NEAREST TO YOU.

Birmingham, Ala.	Crab Orchard, Ky.	Fargo, N. D.	Columbia, S. C.
Hot Springs, Ark.	New Orleans, La.,	North Conway, N. H.	Dallas, Tex.,
Los Angeles, Cal.	1628-38 Felicity St.	White Plains, N. Y.	Bellevue Place.
San Francisco, Cal.,	Portland, Me.	Columbus, O.	Richmond, Va.
1170 Market St.	Lexington, Mass.,	Cor. 3rd and	Seattle, Wash.
West Haven, Conn.	Grand Rapids, Mich.	Dennison Aves	Huntington, W. Va.
Washington, D. C.,	St. Louis, Mo.	Portland, Ore.	Waukesha, Wis.
211 N. Capitol St.	2803 Locust St.	Harrisburg, Pa.	Toronto, Ont.
Dwight, Ill.	Boulder Hot Springs,	Philadelphia, Pa.,	Winnipeg, Man.
Charlestown, Ind.	Boulder, Mont.	812 N. Broad St.	London, Eng.
Marion, Ind.	Omaha, Neb.	Pittsburgh, Pa.,	Cape Town, S. A.
Des Moines, Ia.	724 S. 19th St	4246 Fifth Ave.	
	Buffalo, N. Y.	Providence, R. I.	

Rev. T. DeWitt Talmage's famous lecture, "Evils of Intemperance," mailed on application



LESLIE E. KEELEY, M.D., L.L.D.

Last year the Marble Axe Co. sent me one of their pocket axes, ordered by you, as a premium. I did not have occasion to test its qualities until last Christmas day, when I tried to cut a hard hearted evergreen for a Christmas tree. The edge of the axe crumbled badly and I could not cut off the tree. I wrote the Marble people about it and they at once asked me to return the axe, assuring me they would make it good. I returned it to them and in a short time received a new axe by express repaired.

I would be pleased if you could print a statement of this transaction in RECREATION to prove to its readers that the Marble people are square gentlemen. The new axe is all right in every respect.

Louis R. Bristol, Avon, N. Y.

Hungry Hawkins—Do yer mean ter say yer got a square meal out o' dat sour woman?

Diplomatic Mike—Sure!

Hungry Hawkins—Well, yer a wonder. How'd yer do it?

Diplomatic Mike—When she opened de door I sez: "Is yer mother at home, Miss?"
—Philadelphia Press.

IN ANSWERING ADS. PLEASE MENTION RECREATION.

P. D. ARMOUR,

Head of the great Armour Packing Company, Chicago, Ill.,
(in a personal letter to Dr. Keeley) said:

I have sent about two hundred of my employees, from butchers to foremen, and all have been permanently cured. I do not think there is any one thing, or any one man, who ever did the good to humanity that you are doing with your cure.

Details of treatment and proofs of its success sent free on application.

A. F. Misselbach & Bro., of Newark, N. J., have patented and are putting on the market a new governor, for fishing reels, which is well worth the attention and investigation of all anglers. The governor is a friction device placed inside of a balanced handle which may be fitted to any reel used in fresh or salt water angling, by simply taking the old balance handle off and putting the governor handle in place of it. It is admirably suited for black bass, weakfish, striped bass, or any other game fish. You can get a circular giving full information and cut, for the asking. When you write, please mention RECREATION.

C. L. Bradley, of Clarksville, Tennessee, has invented and put on the market a rear sight for double barrel shot guns, that can be easily attached and detached at the will of the shooter. This sight sells at \$1 and Mr. Bradley has issued a circular that illustrates and describes the new device fully. It is certainly worth the while of every bird shooter and trap shooter to get a copy of this circular and study it. In writing for it please mention RECREATION.

RECREATION is fine. I think it ought to be published every day.

Wilson White, Catonsville, Md.

LOOK ON THE CAN FOR THE LITTLE RED DEVIL **UNDERWOOD'S ORIGINAL DEVILED HAM**



In camp, picnic, or home, it will be found not only pure, but delicious and satisfying. Made only of pure spices and sugar-cured ham. There is but *one* deviled ham — Underwood's Red Devil Brand. All others are imitations, but imitations in name only, no more like Underwood's than chalk is like cheese.

Send for book of 43 prize receipts.

WM. UNDERWOOD CO., BOSTON, MASS.

Free:—To any person sending me \$1. for 1 new yearly subscription to RECREATION, I will send a deck of the celebrated golf playing cards.

For 2 subscriptions, a fine artificial minnow listed at \$1, or a spool of 50 yards of Kingfisher No. 5 silk casting line listed at 75 cents.

For 6 subscriptions, a lancewood casting pole, length 5 feet, with middle joint convenient length for carrying, and fine agate tip. This is a pole that can always be depended on as it is made of selected stock. List price, \$5.50. Arthur W. Bruce, 508 Woodward Avenue, Kalamazoo, Mich.

The Bore—Do you know, Miss Alice, Byron's poems completely carry me away.

She—Do they? I'm awfully sorry I have not a copy with me.—Scraps.

No gun of its caliber could make a better pattern than my premium Harrington & Richardson shot gun.

H. P. Hall, Plankinton, S. Dak.

I received the Marble pocket ax. It is a beauty, and I am much pleased with it. I thank you for the prompt attention shown me.

C. W. Chappel, Green Bay, Wis.

A Press Button Hunting Knife

Is one of the best articles a hunter ever carried

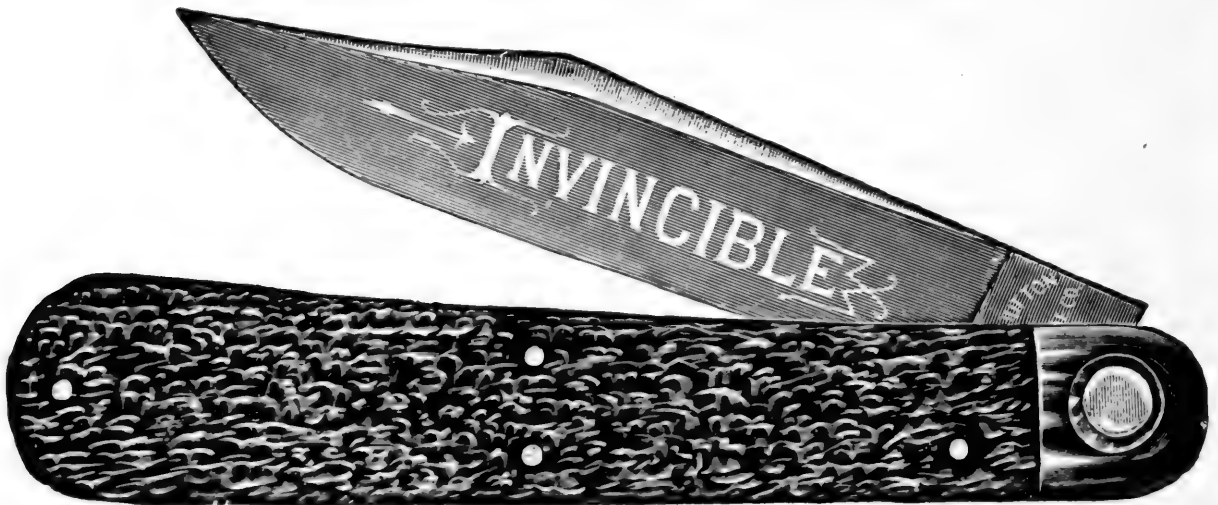

It has a 4 Inch Blade made of the Best Silver Steel

The knife cannot come open in your pocket. It cannot close on your hand when in use. It opens and closes only when

YOU PRESS THE BUTTON

If you once use one of these knives you will never use any other. You can get one as a premium for

3 YEARLY SUBSCRIPTIONS TO RECREATION

Sample Copies furnished on request.



Club Cocktails

Famous the world over for purity. They never vary. The secret of their perfect blend is that they are kept six months before being drawn off and bottled. Be sure you have them in your camp, on the yacht, and on your outing trips wherever you go. They are ready and require no mixing. Simply pour over cracked ice.

For Sale by all Fancy Grocers and Dealers

G. F. HEUBLEIN & BRO.
29 BROADWAY, N. Y. HARTFORD, CONN.

I do not well see how I could get along without RECREATION, for it helps one to live and respect the dumb creatures. Through its persistence against the game destroying porkers, people are being brought to see the necessity of protecting game. My complaint against one dealer in game out of season made him dance to the tune of \$104.55. I don't think he will want another lesson right away.

C. A. Merritt, Marietta, Wash.

Your method of roasting game and fish hogs is certainly good, and is appreciated by all true sportsmen, and the law abiding public in general. It has been my duty to look after poachers the past year, with some good results, but the field is large and hogs are plenty. Don't let people like the Peters Co. discourage you; your work will show when they are dead and gone.

Frank C. Mejdley, Sisseton, S. D.

"Charley, dear," said young Mrs. Torkins, "I have done you a great injustice."

"In what way?"

"I suspected you without reason. I asked several of your friends that you go out with of evenings whether you knew how to play poker, and every one of them thought a minute and said you didn't."—Washington Star.

I am the Toffee King

and I have decided to talk especially this month to those

Who Sell Candy

I am the largest candy manufacturer in the world. The sales of my one brand reach the enormous amount of 300 tons a week. I have built up this enormous business because I have the biggest proposition for those "who sell candy."

MACKINTOSH'S TOFFEE

is a remarkable seller, because it is "moreish;" the more people buy of it, the more they want of it.

If any of my large forces of salesmen have not reached you as yet, it is because they have been very busy; but I want to secure your order by mail, for JUST ONE 4-LB. CAN just to show your customers what the goods are and prove to you what a seller Mackintosh's Toffee is. Send me \$1.00, the retail price for a 4-lb. tin, and I will pay all express charges; and, furthermore, I will return to you the trade discount with the Toffee, provided you make application upon your billhead or enclose your business card. Now don't delay; order today.

CHURCH BAZARS—We invite persons working for basars, fairs, socials, and garden parties to write us for our interesting and profitable offer. We will send any reader of this publication a trial package for Ten Cents in stamps to pay postage.

Beware of Substitutes.
Lamont, Corliss & Co.,
Importers,
78 Hudson St., New York.



FREE ON APPROVAL

The Hawkeye Refrigerator Basket

Is made of the best rattan it is possible to purchase, with a water-tight, non-rustable metal lining and non-conducting insulating of hair-felt and asbestos.

A removable compartment of sufficient size to hold enough ice to keep the contents of the basket cool and sweet for hours (see sectional view below), makes it an ideal acquisition to any sportsman's kit—an ideal utility for all persons going on picnic excursions or outings of any kind.

THE HAWKEYE REFRIGERATOR BASKET WILL LAST A LIFETIME. SENT FREE ON APPROVAL.

READ OUR OFFER.—Send us \$3.50 and we will send you our No. 2 Basket, size 20x12x10; use it ten days, and if not fully satisfied that it bears out every claim we make for it, send it back at our expense and we will cheerfully refund every cent of your money; or, we will send the basket to any responsible person **FREE ON APPROVAL**; test it in any way you like for ten days and if not satisfied it is the best thing you ever saw of its kind for the purpose, send it back at our expense, otherwise send us your check for \$3.50.

We want customers, but we want satisfied customers.

THE HAWKEYE REFRIGERATOR BASKET IS FOR SALE BY DEALERS GENERALLY

Descriptive booklet sent free to interested persons. Better write for it today.

The Burlington Basket Co., 18 Main St., Burlington, Iowa



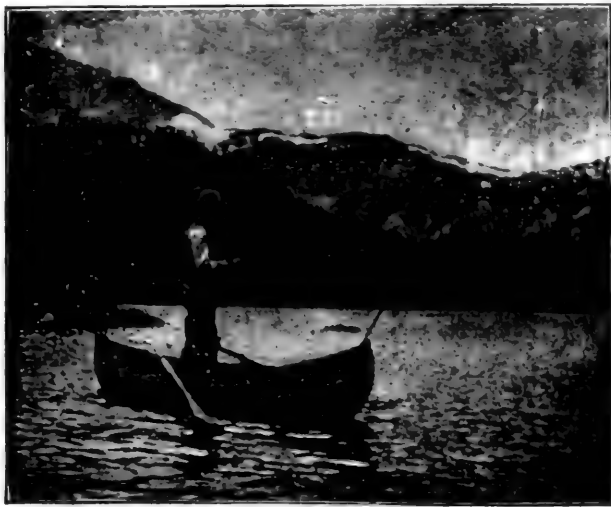

11-foot Special

used by the U. S. Navy. They are simple, wonderful. A thoroughly patented article. Beware of imitations. Made only by ourselves. *A catalog of 100 engravings and 400 testimonials sent on receipt of 6 cents.*

Bottom Boards rest on the frame, not on the canvas, ribbed longitudinally and diagonally. They are *stiffer and safer* than a Wooden Boat because the lines are fuller, and are much easier to row or paddle.

KING FOLDING CANVAS BOAT CO.

Mention RECREATION.

KALAMAZOO, MICH., U. S. A

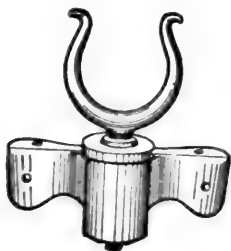

ARE YOU MARRIED to the old style Oarlocks, with their everlasting rattle and squeak? Or could you be **DIVORCED** long enough to try a pair of noiseless, frictionless and durable

BALL BEARING OARLOCKS?

The ideal locks for pleasure rowing, hunting and fishing. Write for prices and descriptive circular. Mention RECREATION

T. H. GARRETT, Jr. AUBURN, N. Y.

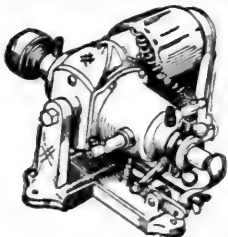

TO OWNERS OF GASOLINE ENGINES, AUTOMOBILES, LAUNCHES, Etc.

The Auto-Sparker

does away entirely with all starting and running batteries, their annoyance and expense. No belt—no switch—no batteries. Can be attached to any engine now using batteries. Fully guaranteed; write for descriptive catalog.

Motsinger Device Mfg. Co.
75 Main St., Pendleton, Ind.

HINTS ON PRONUNCIATION

If the place is on the Chinese coast, remember the number of your laundry ticket, multiply by six, subtract what is left, and find the puzzle. If a Russian name, add three portions, sneeze, cross your fingers, and forget it.—New Orleans Times-Democrat.

Being Exclusively used at the World's Fair.

DEPENDABLE TRUSCOTT LAUNCHES AND MARINE MACHINERY

TRUSCOTT BOAT MFG. CO.
St. Joseph, Mich.

10¢ For Catalog and copy of The Launch

18 ft. Long - 4 1/2 ft. Wide

Non-Sinkable Steel Auto-Boat \$250

Fitted with powerful Automobile, four cycle marine engine, cannot sink, cannot rust. Capacity ten to twelve people.

Nonsinkable Steel Launches, RowBoats, Sail Boats, Canoes, Duck Boats, etc.
Made from the best quality Apollo Steel—will last a lifetime. Send for catalogue. Write for agents' discount.

MICHIGAN STEEL BOAT CO., 1275 Jefferson Ave.
DETROIT, MICH., U. S. A.



THE TEST OF TIME
has proven the superiority
of the
Iowa Marine Engine

OVER ALL OTHERS

Has record of 86,400 miles in four seasons and still in service. Send 8 cents for descriptive catalogue. Mention RECREATION.

Iowa Marine Engine Works
BELLEVUE, IOWA.



Patented
Folding Boat Seat

Can be instantly applied to boats, wagon seats, lawn seats, ball park seats, in fact can be applied to any board seat not over 1 1/2 inch in thickness.

Price, { Corduroy, \$4.00.
Imitation Leather, \$3.50.

Delivered to your address in any part of the United States east of the Rocky Mountains, by

The Old Hickory Chair Co.
MARTINSVILLE, IND.

Mrs. Bacon—I see by this paper that the average family in the United States has 4 7-10 persons.

Mr. Bacon—I suppose I'm the 7-10 in this family.—Yonkers Statesman.

Your magazine could find warm friends in any household.

Jas. S. Mason, Keyport, N. J.

Outlate—Had quite an arg'ment to-day, m'dear, with a college profesor. Now, what's the proper thing to say—"I have drank" or "I have drunk"?

Mrs. Outlate—The proper thing for you to say is: "I am drunk."—Philadelphia Press.

RUSHTON

CANOES



The Canoeing Habit

If you spend your vacations on a lake or river—which is the ideal way—you need a canoe. On hot summer days the coolest place is on the water in the shade of trees. There you can enjoy reading, or talking, or sleeping a hundred times better than on shore.

First, get the right kind of canoe—a Rushton. Ask anybody who has used one, compare it with others, and you will agree that I make the best.

My 30 years' experience built in every one.

My large illustrated catalogue will help you select the kind of pleasure boat or canoe you prefer. Sent free.

J. H. RUSHTON, 817 Water St., Canton, N. Y.

A boy baby arrived at a certain house, and a visitor said to a little girl in the family: "Do you like the baby?" The little girl said she did, but would have preferred a lady baby. "Well," the visitor continued, "maybe you can exchange this one." "No, I don't think we could," said the little girl, "because we have been using it for 7 or 8 days."—Chicago Chronicle.

Webber shooting jacket received. It is just what I have wanted a long time. I thank you very much and hope to get more subscriptions in the near future.

Ed. L. Hall, Allen Grove, Wis.



The Western Recreation Launch

ABSOLUTE LAUNCH SATISFACTION

Is contained in the "Western Recreation." It possesses those essential points, Grace, Beauty of Outline, Symmetry, Simplicity and Safety. Speed is there too if you want it. Most reasonable in first cost, most economical to maintain.

THE BEST FINISHED, HANDSOMEST, MOST RELIABLE.

We build them with either Torpedo or Semi-Elliptic Hulls, and in completeness, it is the ideal and dependable craft for both pleasure and security.

The Western Marine Engine Will please those who build their own hulls. Beautiful Art Catalog describing our Launches and Marine Engines sent upon receipt of 10c. Catalog L.

Western Launch and Engine Works, No. 12 Linn St., Mishawaka, Ind.

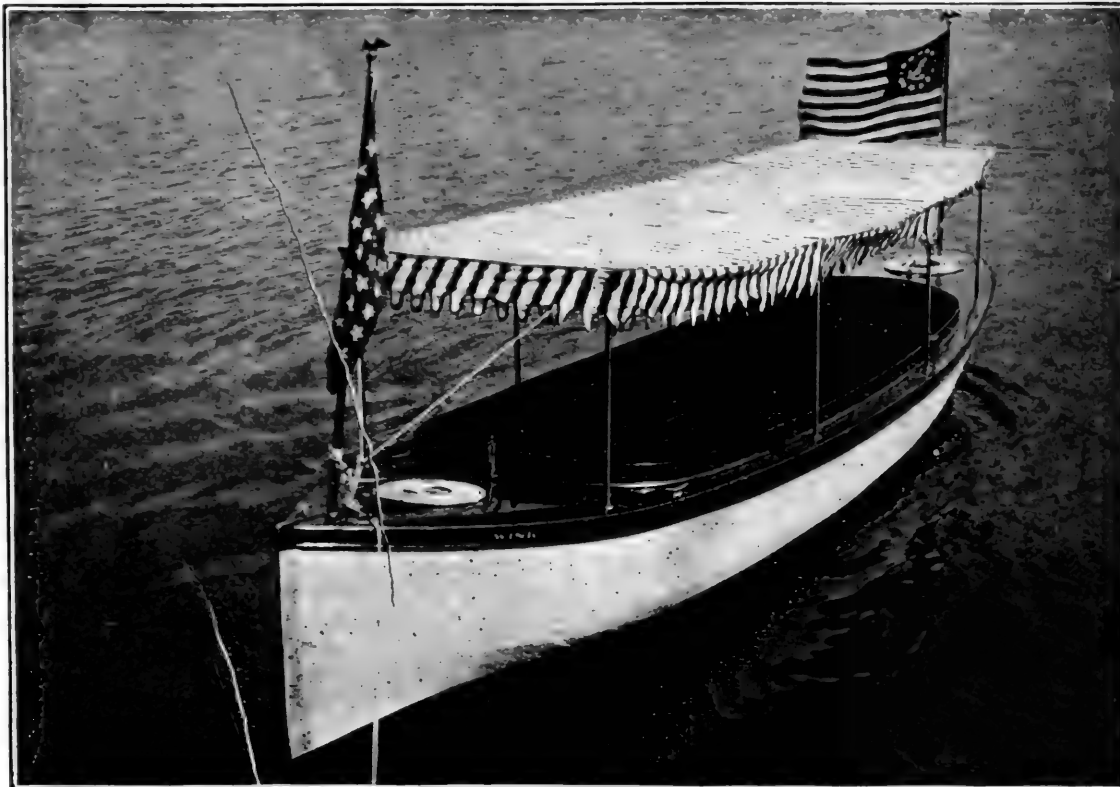

GASOLINE ENGINES and LAUNCHES UP TO DATE
 Self-Starting Jump or Break Spark Catalog Free
D. M. Tuttle Co. 10 Pine Street **Canastota, N. Y.**

RELIANCE

MARINE MOTORS FOUR CYCLE

LIGHT

POWERFUL

ECONOMICAL

1 to 6 Cylinders

4 to 150 horse power

Special Design for Auto Boats

Write for information and prices

RELIANCE MFG. CO.

City Island, N. Y. City

**Gasoline and Steam
Engine Repairs**

Mention RECREATION.

Fay & Bowen

Motors & Launches

Operated by
**GASOLINE
VAPOR**
Motors 1½ to 25 H.P.

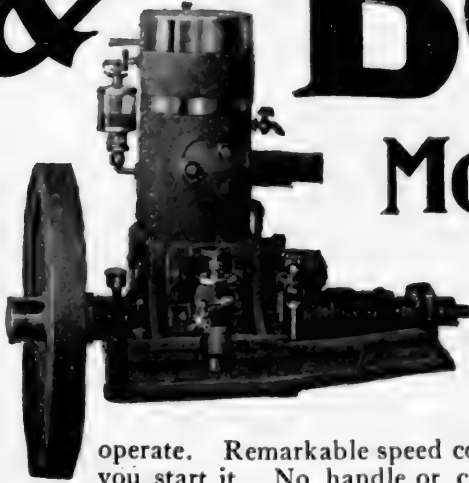

The Fay & Bowen Marine Motor is a revelation to those who have used others. Reliable, safe, durable and easy to

operate. Remarkable speed control. Best of all, it starts when you start it. No handle or crank is used. Our patent igniter is absolutely unique and always instant and positive in action.

It is really the only perfect and satisfactory igniter.

Motors complete from 1½ to 25 actual Horse Power ready for installation.

We also build a line of the finest launches afloat, complete and with our motor installed and all ready to run. We make these in either the usual round stern model or our flat stern torpedo model in lengths from 18 to 35 feet. We can furnish large cabin launches on special order. For excellence of workmanship and beauty of finish and design our boats are unsurpassed. Ask for description of our fast torpedo outfits.

Send for Catalogue and live testimonials from satisfied customers. Our customers are our best advertisers.

FAY & BOWEN ENGINE CO. ⁷⁴ Lake Street, Geneva, N. Y.
(Formerly Auburn, N. Y.)

FISHERMEN

who are critical are the ones we are
looking for to examine our New Specialties

Perfection Fly Rod, Split Bamboo, Ger. silver mountings, extended ferrules, guaranteed, all lengths and weights, each **\$10.00**

KNOX Split Bamboo, either fly or bait, good quality stock, ea. **6.00**

M-1 Split Bamboo, Fly Rod, extra tip, cork grasp on covered form, each **\$3.00**

Triumph Casting Reel, quadruple, Kentucky patterns. Has a take-apart device, wide spool, 1½ in. German silver, 60 yards **\$5.00**

Oneko Casting Reel, rubber quadruple multiplying reel, steel pivots with metal bands on side plate **3.00**

Ideal Casting Reel, nickel plated quadruple reel, steel pivots, balance handle, click and drag. 60 yds. **2.00**

A 100 Page Catalogue describes the variety that we carry in this line.

Mention RECREATION.

Schoverling, Daly & Gales

302 and 304 Broadway, New York

THE LATEST, SAFEST AND BEST CANVAS BOAT

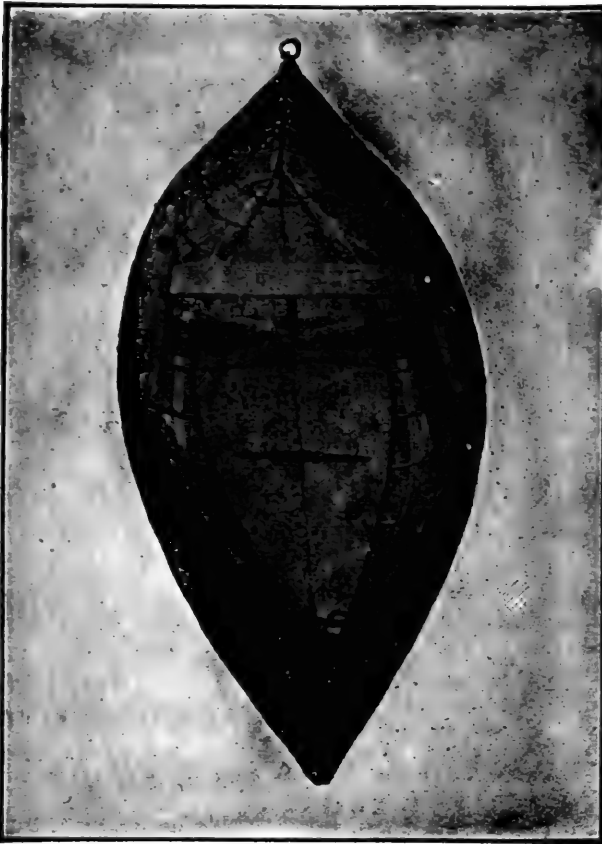

Is what we offer you. A Boat built on modern lines that will prove a pleasure to own and use. Selected materials used throughout, and it comes to you **guaranteed** the best. A handy and safe boat for fishing and shooting. Send 4 cents in stamps for catalogue and reliable testimony.

Mention RECREATION.

LIFE SAVING FOLDING CANVAS BOAT CO.
757 Portage St., Kalamazoo, Mich.



Latest patent and improved Canvas Folding Boat on the market. Puncture proof; Tempered steel frame. No bolts to remove. Folds most compact of any boat made.

CANOES and ROWBOATS
Built of Maine Cedar, covered with best canvas. Made by workmen who know how. Models and sizes for all kinds of service. From \$28 up. Satisfaction guaranteed.
Send NOW for Free Illustrated Catalogue.
Old Town Canoe Co., 28 Middle St., Old Town, Me.

I have been looking over RECREATION again and think you sock it to the game hogs in just the right way. A hog has a thick, tough hide, and a fine cambric needle is scarcely the instrument with which to penetrate it. Right down, outspoken abuse is the only thing a game hog can understand.

Alex. W. Russell, Middletown, N. Y.

EASIER TO ROW ABSOLUTELY SAFE

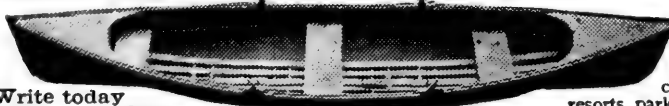

Write today for free catalogue.
15 foot boat, crated **\$29**

Especially valuable at summer resorts, for family boating.

Mullins Galvanized Steel Pleasure Boats

Made of steel. Practical indestructible. Air chamber each end. Cannot leak. Require no caulking. Ideal boat for family use, summer resorts, parks. Guaranteed. Will seat five persons in comfort. The modern row boat for pleasure, safety and durability.
W. H. MULLINS, 228 Depot Street, Salem, Ohio

"TAKAPART" REEL

(No tools required.)

"Best Casting"
Reel
on Earth

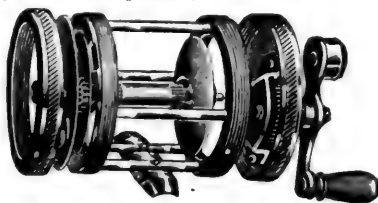

Very Smooth Running.

Highest finish and workmanship. Handle is adjustable in any position. Bearings on spool are adjustable, with which a slight friction can be applied to prevent back lashing. Quadruple action. Compare it with any other, if it is not the best by all odds, return it. 60 yd. \$5, 80 yd. \$5.50, 100 yd. \$6. With "Automatic" Click, 50c extra. **From all Dealers.** Send for Catalogue.

A. F. MEISSELBACH & BRO., Mfrs.

Mention RECREATION. 6 Prospect St., Newark, N. J.

PATENTS

promptly obtained **OR NO FEE.** Trade-Marks, Caveats, Copyrights and Labels registered. **TWENTY YEARS' PRACTICE.** Highest references. Send model, sketch or photo. for free report on patentability. All business confidential. **HAND-BOOK FREE.** Explains everything. Tells How to Obtain and Sell Patents, What Inventions Will Pay, How to Get a Partner, explains best mechanical movements, and contains **300 other subjects** of importance to inventors. *Address,*

H. B. WILLSON & CO. Patent Attorneys
786 F Street, N. W., WASHINGTON, D. C.

Duxbak

Sportsman's Coat

Sheds Water Like a Duck's Back

Positively waterproof and rain defying. Made of fine duck as soft and pliable as chamois. Lined throughout with same material. Treated by a patent process that resists a driving rain or an all day drizzle and yet permits perfect ventilation. No rubber of any kind used in its construction.

Guaranteed rain proof under all conditions where a sportsman would wish to use it. Double stitched throughout. Re-inforced shoulder cap. Patent ventilated gusset under arm allows free arm movement with rod or gun. Corduroy collar and cuffs. Full cut and well tailored. Light tan or dead grass color.

EASY AS A SWEATER

Price \$5.00 express prepaid. Give snug breast and waist measure, height and length of arm from center of back. State color desired. Samples free.

BIRD, JONES & KENYON,
No. 1 Blandina St., Utica, N. Y.



WOULD YOU ACQUIRE

Manly Bearing
Erect Carriage
Grace and Elegance of Movement
Perfect Muscular Development

If so take a course of training in

THE NEW METHOD OF FENCING

as taught by

LIEUT. J. MARCZI DE ZOLDY

Late of the 25th Regiment, Austro-Hungarian Army.

STUDIO:

489 Fifth Avenue, New York City

Write for terms and full information

I have been a reader of RECREATION over 5 years and think it the best magazine published, for all true sportsmen. I like the way you roast the game and fish hogs, for they need it.

Raymond Hagar, Traverse City, Mich.

"He doesn't know enough about the law to be a successful lawyer."

"Well, let's make him a judge."—Chicago Evening Post.

Ethel—Marry him! Why, I'd die first!
Edith—Nonsense, dear. He is not as strong as he looks.—Puck.

Hamper-Trunk

\$4.00

Stronger than a Trunk
As light as a Basket



Can be used for a hamper or packing-trunk at home, will outwear a ten-dollar trunk on the road. Just the thing for the summer tourist or camper. Made in all sizes. 32-inch size, \$4.00. Freight paid east of the Mississippi river and north of Tennessee.

SCHWANBECK BROS.
450 Milwaukee Ave., Detroit, Mich.



VOLCANO

SPIRIT GAS Stove

Makes its own Gas

For camp, home and travelling
Burns Spirits or wood alcohol

COST OF FUEL

$\frac{1}{2}$ cent per hour.

Always ready—Can't explode.
Heats quart of water in five minutes. No soot. Easily carried. Price, highly nickled,

\$1.00 postpaid.

J. C. PAUL & CO., Sole Mfrs. 59 Dearborn St., CHICAGO, ILL.

At last a Perfect Fishing Tackle Box

No trays to spread out and spill about.



Patent applied for.

Take this up-to-date convenience on your vacation trip and have everything for Fishing literally at your finger tips. Our **Special Holdfast Lock Loop** not shown in cut is a decided winner. Sent carriage paid on receipt of \$2. with privilege of return if not satisfactory

References: RECREATION, New York City.
Yale National Bank, New Haven, Conn.

Merriam Mfg. Co.

DURHAM, CONN.

Sole makers of Johnson Trayless Tackle Box.

Small Profits—Quick Sales

TROUT FLIES

for trial—send us



- | | | |
|-----|---|-----------------|
| 15c | for an assorted sample doz.
Regular price, 24 cents. | Quality A Flies |
| 30c | for an assorted sample doz.
Regular price, 60 cents. | Quality B Flies |
| 60c | for an assorted sample doz.
Regular price, 84 cents. | Quality C Flies |
| 60c | for an assorted dozen
Regular price 84 cents. | Bass Flies |

SPLIT BAMBOO RODS

Fly Rods	57 cents	Bait Rods
10 feet, 6 ounces		9 feet, 8 ounces
With cork grip and extra tip, in wood form		

THE H. H. KIFFE CO.
523 Broadway, New York City

Catalogs of any of above goods free on application.
Mention RECREATION.

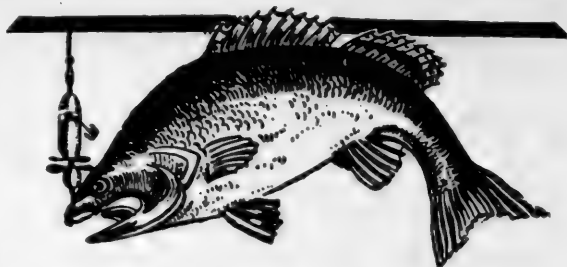

Fine Fishing Tackle Free

I want every enthusiastic fisherman, whether amateur, beginner or professional, to have a personal knowledge of the fine points of the Shakespeare Reels and the marvelous catching qualities of the Shakespeare Baits—and to do this I propose to send to every man or woman who fishes for the real sport there is in it, one of my reels and baits for free trial on their next fishing trip. Write to-day. Send your name and address and the name and address of the leading sporting goods dealer of your city to Wm. Shakespeare, Jr., 404 Shakespeare Bldg., Kalamazoo, Mich. The Shakespeare Reel is especially designed for accurate and long-distance casting, and it is without doubt the best reel in the world, and you will say so when you see it. The metal used in the Shakespeare Reel is hard-drawn brass and the finest English Stubbs steel. Painstaking care is used to secure perfect accuracy in every detail. In beauty of design, and simplicity of construction it is unequalled. Its easy, silent running suggests perpetual motion and it is fitted with the most perfect drag and click ever invented. Words will not describe its beauty, its usefulness, nor its many advantages over all other reels. My reels and baits are for sale by all first-class dealers but I want you to see them and try them for yourself and I will send them to you direct, express prepaid, for a free trial. The Shakespeare Baits are really marvelous. With them the fisherman is sure of a good catch, no matter where the fish are, in the lake or stream. If they are in deep water, Shakespeare makes the bait that attracts them. If they are in shallow water, Shakespeare makes the bait that catches them. If they are hidden in the lily pads or moss, Shakespeare makes the bait that makes them strike. And Shakespeare offers \$100 in prizes for the photograph and authentic dimensions of the biggest large or small mouth bass caught this year. Write to-day for particulars. His little booklets, "How to Catch Bass," "Shakespeare Fine Fishing Tackle" and "The Art of Bait Casting," are free to every angler. Write to-day.

If You Want to Double the Enjoyment in Landing Your Fish Use

THE LIBERTY REEL

**Best Model and Most Improved
Fishing Reel Yet Produced**

Special Features The drag is applied by the handle. Tension of click adjusted at will, or Free Running if preferred. Easily and quickly taken apart. German Silver and Hard Rubber. Three Sizes.

Surely See This High-Grade Reel

After using this reel half a day, all others are thrown aside.

Prices, 80-yd. quadruple, \$6.00; 100-yd. quadruple, \$7.50; and for lake trolling, 250-yd. double, \$9.00.

WE ARE ALSO AGENTS FOR

**King's Prepared Shiner Bait,
Groul's Tackle Boxes and Minnow
Palls, Milward's Angler
Spinners, Blue Label
Enamel Lines, etc.**

Send 10 cents in stamps for the Finest Catalogue of Highest Quality Fishing Tackle published in America. 100 pages. Mention RECREATION.

WM. READ & SONS

Established 1826

107 Washington Street, Boston

Quail were fairly plentiful here last year, ducks and geese the same. The wild turkey is disappearing rapidly as it is hunted at all times of the year. Barring that, however, the game laws are much more respected than you would imagine. Putting the law on antelope for 5 more years was one of the best things that could have been done. They are anything but plentiful. We have several small bunches on the Hash Knife ranch, and are protecting them as much as possible.

Mark Hopkins, Jr., Seymour, Tex.

A coroner is a doctor whose duty it is to inspect cases where persons have died without medical assistance.—Grit.

I often wonder how you can give such valuable presents for so little work. My brother and I have obtained through RECREATION a Bristol steel rod, a pair of hunting boots, a 9 x 12 wall tent and a Marble pocket axe. My worst wish for you is that you may live many years and may see the result of the good work you are doing. The memory of your valuable magazine will live in the minds of American sportsmen forever.

L. E. Wooer, Empire, Mich.

Her Father—What! You say you're engaged to Fred? I thought I told you not to give him any encouragement.

His Daughter—I didn't. He didn't need any.—Fun.

Our Detachable Even Spoolers



WHEN attached to a good reel make the best casting and fishing outfit on earth at about half the price of old style. They give perfect satisfaction in every case. To prevent regret later on, don't buy the wrong reel. Our free catalog (B) names reels spooler will fit. Price and description of spoolers, gun cleaners, fish scalers, ball bearing, jeweled, and steel pivot bearing reels fitted with 'even spooler. Our new rubber hook-shield binds hook and line securely to rod when not in use. All sorts of trouble and profanity prevented in an instant.

**A. W. BISHOP & SON, PATENTEES AND MANUFACTURERS
RACINE, WIS., U. S. A.**



Don't suffocate yourself with fly-nets. Don't use ill-smelling pastes and heavy oils which make your face feel like sticky fly-paper.

USE PRESTO

It is colorless, has a pleasant odor, is non-poisonous and
LEAVES NO STAIN

PRESTO is guaranteed to keep mosquitoes, black flies, midges, and punkies from biting.

Presto Kills all Insects

and is invaluable as a kennel requisite, eradicates unpleasant odors and kills fleas and their larvae. No sportsman's camp is complete without a bottle of PRESTO.

Make your dealer send for it, for if you use Presto once, you will want more. Sample Can will be sent by mail for **20c** postpaid.

Presto Manufacturing Co.

Lock Box 1248

When writing mention RECREATION.

OSSINING, N. Y.

BUILD YOUR OWN BOAT
BY THE "BROOKS SYSTEM"

16 FT.-LONG. Exact size PATTERNS of every piece. Complete IN-4 FT.-BEAM. STRUCTIONS. Each step plainly ILLUSTRATED. Experience unnecessary. Hundreds have built this boat. PATTERNS \$5. working spare time, at a total cost of \$14.00.

COMBINATION LAUNCH-SAIL & ROW-BOAT. Boat Patterns of all kinds and sizes up to 5 ft. at prices from \$3.00 up. We also build complete boats and knock down frames. PARTICULARS FREE - 25¢ brings 64 p. illustrated catalogue. set of working instructions and illustrations.

BROOKS BOAT MFG. CO. STA. B BAY CITY, MICH

Your premiums are very liberal, and subscriptions are easily obtained.

Jas. R. Taylor, Boston, Mass.

Game is plentiful around here. Several rabbits lived all winter in the wild grapevines in the ravine back of our house, and I have seen grouse tracks in our hen yard. One day I was snow-shoeing in the ravine back of the house and saw a large cock grouse scratching in a spring. He scratched the leaves out and then stood a moment as if waiting for the water to clear. He stood erect with his enormous ruff standing straight out and then stooped and took a sip like a hen. As I moved forward to get a better view, he heard me and was gone like a flash.

N. C. Burnham, Jonesville, N. Y.



ACME FOLDING BOAT CO., MIAMISBURG, O.

Government, who prefer our boats. Received medal and award at Chicago World's Fair. If you investigate we will get your order. Mention RECREATION.

Acme Folding Boat Company, Miamisburg, O.

A Sportman's Boat MULLINS "Get There" Steel Duck Boat



14 ft. long, 36-inch beam.

Price \$20—Crated on cars Salem
Endorsed by Thousands of Sportsmen. Air Chamber each end. Always ready. No repairs. Send for handsome free book.

W. H. MULLINS

228 Depot Street, Salem, Ohio

"BRISTOL" RODS

on the St. Lawrence River

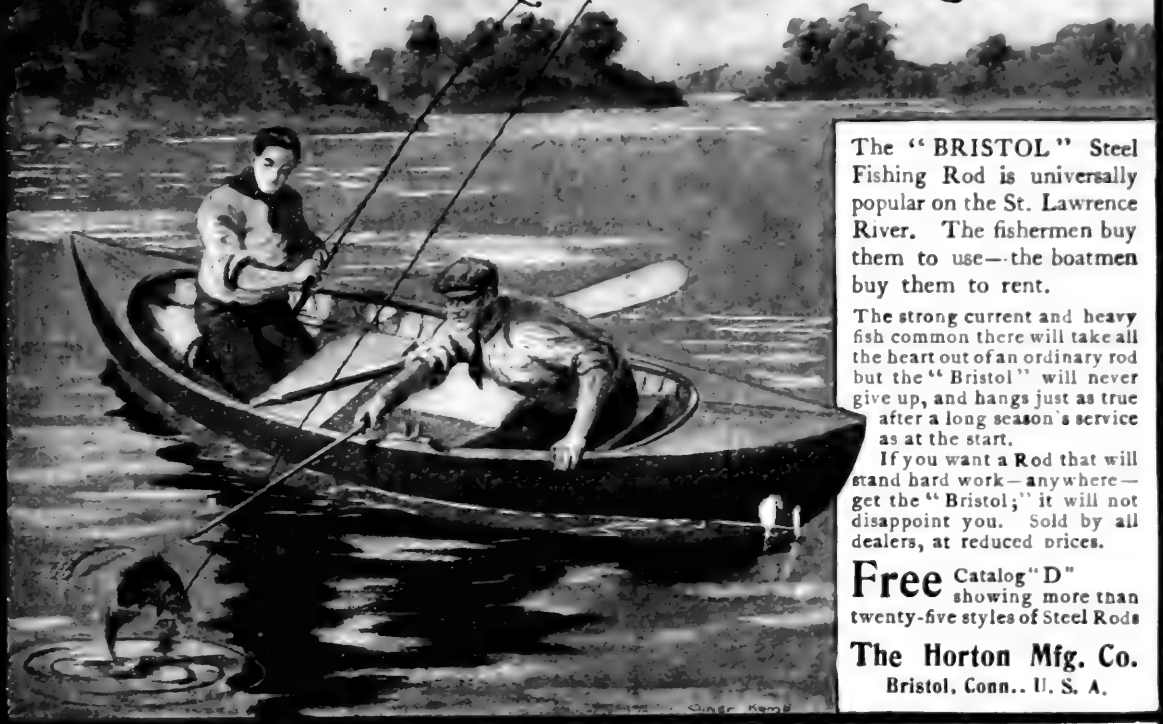

The "BRISTOL" Steel Fishing Rod is universally popular on the St. Lawrence River. The fishermen buy them to use—the boatmen buy them to rent.

The strong current and heavy fish common there will take all the heart out of an ordinary rod but the "Bristol" will never give up, and hangs just as true after a long season's service as at the start.

If you want a Rod that will stand hard work—anywhere—get the "Bristol;" it will not disappoint you. Sold by all dealers, at reduced prices.

Free Catalog "D" showing more than twenty-five styles of Steel Rods

The Horton Mfg. Co.
Bristol, Conn., U. S. A.

"BRISTOL" RODS

for
Black Bass

BLACK BASS—"He is a fish that lurks close all winter, but is very pleasant and jolly after mid-April and May and in the hot months."—ISAAC WALTON.

Get your bite—the "Bristol" will do almost all the rest. It has the necessary spring, snap, and stiffish back required in a Black Bass Rod. The most resilient material used in rod making is Steel, which makes them tough and elastic, with a rebound found in no other rod but the "Bristol."

Sold by all dealers; they will give you the benefit of reduced prices

Free Our handsome catalog "D" describing all the "Bristol" steel rods.

THE HORTON MFG. CO. Bristol, Conn. U. S. A.



Established
1840

Geo. B. Carpenter & Co.
Makers of High Grade
**Tents, Sails, Camp
Furniture** Folding Cots, Tables, Chairs,
Oars, Paddles, Marine
Hardware

The Largest and most Complete Stock in the U. S.

Send 4c. in stamps for Tent and Camp Catalogue, or 6c. in
stamps for Marine Hardware Catalogue.
Mention RECREATION

200, 202, 204, 206, 208 S. Water St.
**CHICAGO
ILL.**

Geo. A. King

Anything That's Knit



BLAUVELT'S HUNTING AND FISHING COAT.

Good Agents Wanted

BLAUVELT'S

Hunting and Fishing COATS

THE BEST THAT'S MADE

In Oxford Grey or Dead Grass, or any other color or combination of colors, made to your measure.

Sweaters of all kinds — for Men, Women, Boys and Girls. The correct and comfortable garment for the seashore, country or mountains.

*Mail Orders promptly
Attended to.*

Mention RECREATION

BLAUVELT KNITTING CO.

148 and 150 Central Ave.

Newark, N. J.

VACATION LIGHT

Equal or better than your light at home. One gallon gasoline lasts all summer in our

Brilliant Gas Lamps

They make their own gas, while they burn 100-candle strong. For in or outdoor use; portable, light and handy. Can be hung anywhere. Safer and cheaper than kerosene. If you are not using them, write for our "R" catalog, or we will send a lamp like cut, complete, ready for use, to your nearest express station prepaid on receipt of \$5.00, every lamp guaranteed.

Mention RECREATION.

BRILLIANT GAS LAMP CO.,
42 State St., Chicago, Ill.



100-candle power.

I am in receipt of the 4 x 5 Weno Hawkeye camera you gave me as a premium. The camera is the best made and the simplest to operate of any I have examined. I advise anyone wanting a first class camera to get a Hawkeye and those desiring good reading to take RECREATION.

John D. Burns, Weiser, Idaho.

You are doing a good work, and I like to see the fish and game hogs called down properly by a man who does it without fear or favor. May you receive 10 subscriptions from sportsmen for every one you lose by roasting a hog.

A. G. Russell, Wabeno, Wis.

Montana Copper Mines: I have some very promising prospects in Northwestern Montana carrying gold, silver and copper values. Would sell outright, bond or give an interest to secure capital to develop property.

If you are interested, it would pay you to write me.

Sidney M. Logan, Kalispell, Montana.
Satisfactory references furnished.

"This paper says if spots appear before your eyes it will give you a headache."

"Yes, they gave me a headache last night."

"What kind of spots were they?"

"Seven spots, and the other man held aces.—Exchange.

Practical Common Sense **CAMP STOVE** in 6 Sizes.

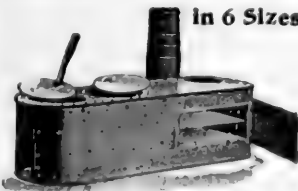

Either with or without oven. The lightest, strongest, most compact, practical stove made. Cast combination sheet steel top, smooth outside, heavy lining in fire box and around oven, holds its shape, telescopic pipe carried inside the stove. Burns large wood and keeps fire longer than any other. Used by over 9,000 campers and only one stove returned.

For catalogue giving full particulars, mention RECREATION and address

D. W. CREE, Manufacturer, Griggsville, Ill.

FREE To Sportsmen. Our new Illustrated Catalog. It tells how we can teach you to

Be Your Own Taxidermist

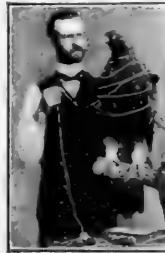

Learn to save your fine trophies. They are magnificent for your home, or den. Taxidermy is easily and quickly learned under our instruction. Complete course of 15 lessons and personal instruction. Standard methods, reasonable cost. The spring shooting season is open. You will get some fine birds. Mount them for yourself. Our school is endorsed by all leading sportsmen in the country. May we send you our catalog? It tells you all about the school, and it's yours for the asking. Write for one today and mention RECREATION.

The Northwestern School of Taxidermy,
Suite A., Com. Nat. Bank . . . **Omaha, Neb.**
The only School of Taxidermy in the world.

FOR Solid Comfort

SUMMER or WINTER

The
Best
is
the
Cheapest



Get a pair of
**Thompson-
Quimby
Hunting
Boots**

I Make the Best

All work guaranteed. I refer by permission to the Editor of RECREATION. Measurement blanks and prices on application. Mention RECREATION.

T. H. GUTHRIE

33 William St.,

NEWARK, N. J.

A VALUABLE PRESENT

**For Your Wife, Your Mother, Your
Sister or Your Best Girl**

For **25** Yearly Subscriptions to RECREATION, I will send you
a set of

1 DISH AND 12 TOMATO PLATES

made by Higgins & Seiter, 50 West 22d Street, N. Y. Listed at
\$19.50.



And, for **20** Yearly Subscriptions to RECREATION, I will send you a set of

12 WATERMELON PLATES

listed at \$16.50. (See illustration)

THESE are fine, thin, white china plates, beautifully hand painted, with pictures of tomatoes and tomato vines, or watermelons and watermelon vines, in natural colors, and each set of plates is enclosed in a case made in an exact imitation of a large tomato or a watermelon.

No more beautiful or appropriate present could possibly be found for a lady than one of these sets.

You can earn one of them in a few hours, and at the same time earn the everlasting gratitude of the lady to whom you may give it.

SEND FOR PACKAGE OF SAMPLE COPIES FOR USE IN CANVASSING

Recreation w. ²³24th Street, **New York**

Rambler
Touring Cars

Simple, Powerful, Durable.

Rambler Touring Cars give thorough satisfaction at a minimum of cost. Model H, with tonneau, as shown above, only \$850. Without tonneau, (Model G) \$750.

Eight models, \$650.00 to \$1,350.00 at the factory.
Write for catalogue and proof of Rambler superiority.

Model "H"
\$ 850

Thos. B. Jeffery & Company, Kenosha, Wis., U. S. A.
Chicago Branch, 304 Wabash Ave. Boston Branch, 145 Columbus Ave.

I have read RECREATION 4 years and it does more for game protection than all the other magazines combined. There is plenty more work to be done, however. Queechy Lake is noted for its fine pickerel, and certain people here fish it all winter. As soon as the ice will bear them they set tip-ups and leave them out until March. Much of the time the lines are frozen in the ice. When that is the case, why could not the owners be prosecuted under the law forbidding the use of set lines. What would a court be likely to rule in such a case? If a baited but unwatched and frozen tip-up is not a set line, what is it? If a test case could be brought it might serve to limit a vicious and destructive method of fishing.

A. B. C., Canaan Corners, N. Y.

Will some lawyer please answer?—
EDITOR.

I received my Malcolm telescope as a premium from you and am delighted with it. It surpasses anything I ever expected to get and is first class in every respect. I can not see how you can afford to give such nice premiums. I shall do all I can to promote the welfare of RECREATION.

Frank W. Fuller, No. Bennington, Vt.

Dick—How did you know when it was time to leave her house if the parlor was dark?

Fred—A little bird told me.

Dick—Get out!

Fred—Yes. The cuckoo came out of the clock and called 11.—Philadelphia Record.

Swedish COLLAN OIL
Waterproof LEATHER DRESSING AND RUST PREVENTER

"Collan-Oil"
preserves leather and renders shoes and harness positively **WATERPROOF**

Used by the U. S. the Army and Navy and National Guard.
Send 25c. for trial can.
AGENTS WANTED

Write for terms and circulars
J. R. BUCKELEW
Dept. A. 111 Chambers St., N. Y.

JAPSTICK
DRIVES AWAY
Black Flies
and
Mosquitoes

Each Stick Burns an Hour
Full box sent postpaid for 50 cts.

The Culecide Co., 170½ Summer St., Boston



The Sports- manlike Qualities of a "Y and E" Auto- matic Reel



Skykomish River, Wash., where "El Comancho" caught the 15 lb. (Record) Rainbow Trout

will be greatly admired by every true angler.

¶ The pleasure of playing your fish is not diminished in the least by the Automatic feature.



Little Finger does it

¶ On the other hand, the knowledge that only a slight pressure of the little finger is needed to keep your Gamy Fighter from dislodging the hook, gives a zest to the sport which the user of the ordinary crank reel can never know.

¶ Nothing is so aggravating as to have the Scaly Gentleman drop your hook after the battle is almost won.

¶ A "Y and E" Automatic Reel takes up the slack just as fast as he makes it, and exerts a tension that keeps him from stripping your reel.

¶ Besides all this, a "Y and E" Automatic-Combination Reel may be made either free running (just like any other reel) or automatic, by the simple pressure of a slide. You make your cast free-running; you reel in your line automatically. Beats winding a crank like fury!

¶ Write today for our handsome new booklet No. 101—"When Pardner was Mascot"—the exciting story of the Record Rainbow Catch—made with a "Y and E" Reel.



"Pardner" and the "Biggest Bunch of Trouble that ever Wore Gills"

BOOKLET 101
SENT POSTPAID ON YOUR REQUEST

Yawman & Erbe Mfg. Co.
Rochester, N. Y.



The Car of Highest Grade

Among all means of travel—and among all automobiles—the Cadillac stands pre-eminent as a hill-climber. A locomotive can go up a 10% grade; a trolley car 15%; a bicyclist, if his wheel be not geared too high, 20%; a horse with a light carriage 25%; A

CADILLAC

45%

Hill-climbing ability is attainable thro low gearing—*speed* with hill-climbing ability only thro a plenitude of power. 30 miles an hour with four passengers is easy for the Cadillac—and easy on the passengers. Smooth riding, powerful, absolutely dependable, the Cadillac is a car surprising alike in performance and in cost.

Prices range from \$750 for Model A Runabout to \$900 for Model B Touring Car or Surrey. If you'll ask us we will be glad to send Booklet K—a complete exposition of Cadillac excellence. We'll also tell you of a nearby agency where demonstrations are given—for most Cadillacs are sold by being seen and tried.

CADILLAC AUTOMOBILE CO., Detroit, Mich.
Member Association of Licensed Automobile Manufacturers.

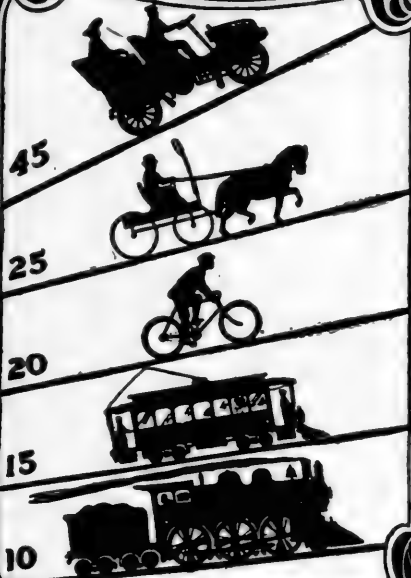

E. B. Brigham, M. D., of Indianapolis, asks how many of your readers have eaten deer's liver? I have, more than 100 times, during some 30 years of deer hunting. Among old hunters the liver, kidneys and heart are looked on as the only meat that can be eaten without bad results while the carcass is still warm. Too fresh venison steak usually acts as a cathartic, which leaves Ayers far-famed compound far in the shade. Take note of this, callow sportsmen, when standing with an empty stomach by the side of a fresh killed buck, with camp 10 miles away. Boil a piece of liver or heart on a stick. If you shoot black powder, sprinkle on a little in place of salt—it is first-rate; but don't eat the warm meat.

This part of the Rio Grande valley was, until the new Texas game law was passed, a deer butcher's paradise and game hog's heaven, but it is all off now. In a few years dry goods clerks will be able to kill deer with their yard-sticks in the back yards around Eagle Pass, even though the law is only half observed. Six Shooter Bill, Ciudad Porfirio Diaz, Mex.

He—What's that woman singing over the way?

She—She's singing "My Bonnie Sails Over the Ocean."

He—Well, I bet I know what made him take that trip.—Chicago News,



No Fault of the Auto

That it cost you \$5.00, some profanity and much mortification to be "towed" back. It was the case of a 2,000 dollar machine stalled by a 75 cent set of dry batteries—every autoist has his battery troubles.

The Apple Ignition Dynamo

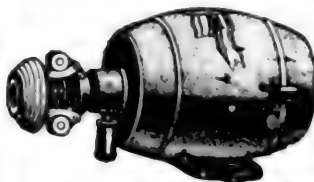

is just what you want—don't depend on unreliable batteries, our dynamo gives you a hotter spark, more power, more speed.

Send for particulars on our ignition apparatus for Automobiles, Launches and Gas Engines.

The Dayton Electrical Mfg. Co.

126 Reibold Bldg., Dayton, Ohio.

GUIDE TO TAXIDERMISTRY.



Full of valuable information, with complete instructions how to prepare and mount

BIRDS, ANIMALS and FISHES.

Also a complete list of all North American Birds, with Prices of their Eggs, Skins, and mounted Specimens, an Exhaustive Line of Ornithologists', Oologists' and Taxidermists' Supplies; valuable information for the amateur. Recipes, etc., etc.

Cloth Bound, 35c., postpaid.

CHAS. K. REED,

102 UNION ST., WORCESTER, MASS.

For Sale: 20,000 buffalo horns, all in good condition. Largest stock in existence. Also designs and patterns for working same into hall racks, mirror frames, chairs, gun racks, electric light brackets, etc. Full information on request. Personal inspection invited. Address, Mrs. E. W. Stiles, No. 306 Ocean Avenue, Bradley Beach, N. J. Mention RECREATION.

Camp sites to rent; 27 miles from New York City. Beautiful lake, cold brooks, heavy forest, excellent roads for bicycling and driving. Address, Abercrombie & Fitch, 314 Broadway, New York. Mention RECREATION.

Wanted.—A 4 cylinder, cabin, gasolene launch of about 48 feet length; must be staunch, almost new and modern; at least 14 miles speed required. Send photograph and full particulars with price. F. F. Peabody, 324 Fifth avenue, Chicago.

For Sale: 2 Mounted Moose Heads; spread 45 inches each; one has 11 points on each horn, the other 9 and 10. Price \$60 and \$50. Photo sent on request. Robert Rice, Wawanesa, Manitoba.

For Sale: 8 Al Vista 4 B Cameras, new and in good condition. Cost \$25 each. Would sell for \$10 each. Address, C. B. Hodgdon, Fort Totten, N. Y.

SOME GOOD GUIDES.

Following are names and addresses of guides who have been recommended to me, by men who have employed them; together with data as to the species of game and fish which these guides undertake to find for sportsmen.

If anyone who may employ one of these guides should find him incompetent or unsatisfactory, I will be grateful if he will report the fact to me:

FLORIDA.

C. H. Stokes, Mohawk, deer, alligators, turkey, quail, and snipe.

IDAHO.

John Ching, Kilgore, elk, bear, deer, antelope, mountain sheep, trout and grouse.
Chas. Petty's, Kilgore, ditto.

MAINE.

H. R. Horton, Flagstaff, deer, bear, moose, caribou, fox, grouse and trout.
Eugene Hale, Medway, ditto.

MONTANA.

A. R. Hague, Fridley, elk, deer, mountain sheep, bear, grouse and trout.
Chas. Marble, Chestnut, ditto.

OREGON.

Charles H. Sherman, Audrey, bear, deer, grouse and trout.

WASHINGTON.

Munro Wyckoff, Port Townsend, deer, bear and grouse.

WYOMING.

S. N. Leek, Jackson, elk, bear, deer, mountain sheep, antelope, grouse and trout.

CANADA.

Carl Bersing, Newcastle, N. B., moose, caribou, deer, bear and grouse.

NEWFOUNDLAND.

John C. LeMoine, Birchy Cove, Bay of Islands, caribou, salmon and trout.

A. M. Pike, Bay of Islands, bear, caribou, salmon trout.

John Gillard, Notre Dame Bay, ditto.

FOR SALE

Indian Relics —Prehistoric Specimens.
Large stock list and photos ten cents.
N. E. CARTER, ELKHORN, WIS.

FINE MOUNTED GAME HEADS, BIRDS, ETC., for sale at unheard-of prices.
Send 10 cents for photos.
JOHN CLAYTON, Taxidermist, Lincoln, Maine

Date, _____ 190

G. O. SHIELDS,

Editor and Manager of RECREATION, 23 West 24th St. New York.
Herewith find \$1.00 for which please send me RECREATION one year beginning with _____ number,

Name, _____

Remit by P. O. or Express Money Order, or New York Draft.

DETACH THIS, FILL OUT, AND SEND IN



THE 1904 Model

LEATHER-COVERED Pneumatic Recoil Pad is now perfect. No pump, no valve, no recoil, no flinch, no headache, no bruised shoulders, no money if not satisfactory and returned at once.

PRICE, \$1.50

J. R. WINTERS
Clinton, Mo.

KOENIG'S SHELL EXTRACTOR.

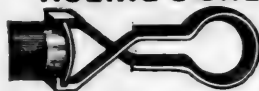

Every shooter should have one—carry it in a vest pocket. Fits any gauge shell. Koenig's Gun Catalogue, Free.

10 Cts. Postpaid.

E.G. KOENIG, NEW JERSEY'S LARGEST GUN HOUSE
SOUTH BROAD ST., NEWARK, N. J.

Taxidermists' Glass Eyes for Stuffed Birds, and Animals
Oologists' and Entomologists' Supplies
Materials

Send 5c. in stamps for catalogue

FRED. KAEMPFER, 88 STATE ST., Chicago, Ill.

Taxidermy work done in all its branches
Mention RECREATION



INDIAN CURIOS

WHOLESALE & RETAIL CURIO DEALERS' SUPPLY DEPOT.

Bead Work, Baskets, Elk Teeth, Mexican Goods, Beads, Fossils, Minerals, Arrow-Heads, Pottery, Alaska Ivories, Shells, Agates, Photos, Great Stock, Big Cata. 5c., stamps. Mention RECREATION. If a dealer say so.

L. W. STILWELL,

DEADWOOD SO. DAKOTA



Squab Book Free



Squabs are raised in 1 month, bring big prices. Eager market. Astonishing profits. Easy for women and invalids. Use your spare time profitably. Small space and capital. Here is something worth looking into. Facts given in our FREE BOOK, "How to make money with Squabs." **PLYMOUTH ROCK**

SQUAB CO., 289 Atlantic Ave., Boston, Mass.

NAVAJO BLANKETS, Indian Beadwork, Baskets, Pottery, Moccasins, Alaskan Curios, Mexican Goods, Beads, Basket Material. If it's Indian we have it.

Send 6c. Stamps for Catalogue.

BENHAM INDIAN TRADING CO.

138 West 42d Street, New York City

Mention RECREATION.



I had a surprising experience last fall while deer hunting in Sullivan county. I stopped at a Canuck's house, over 21 miles from a railroad, and found his stepson reading RECREATION. He had been taking it some years and thought there was nothing like it.

J. H. Cruickshank, Big Indian, N. Y.

NEWHOUSE STEEL TRAPS

Made since 1848 by ONEIDA COMMUNITY

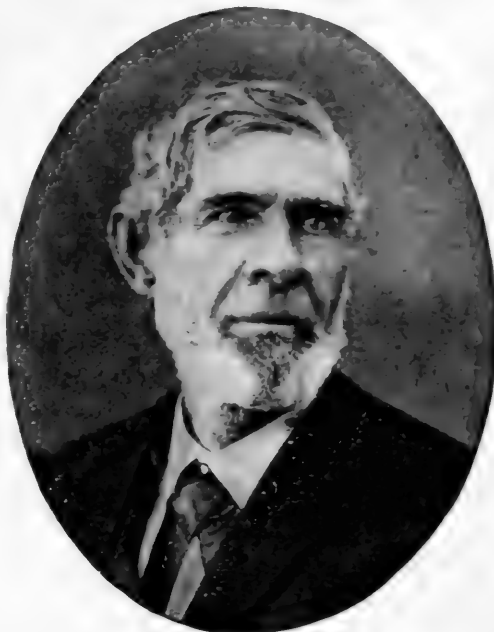

S. NEWHOUSE

(The Old Trapper and Trapmaker)

Fifty years ago this famous old Trapmaker of the Oneida Community would not let a trap leave his hand till he KNEW that it would hold any animal that got into its jaws. Even greater pains are taken now than then in selecting the finest steel and rigidly testing every part.

This is why all experienced Trappers insist on having the

" NEWHOUSE "

"I have seen an Indian trade his pony for one dozen Newhouse Traps."—*Popular Magazine Writer.*

Eleven Sizes for Catching Every Fur Bearing Animal

Every Trap Guaranteed
Illustrated Catalogue Mailed

Send twenty-five cents for "The Trapper's Guide," by S. Newhouse, telling all about fur bearing animals and how to trap them, together with interesting narratives and practical directions for life in the woods.

Mention RECREATION.

ONEIDA COMMUNITY
ONEIDA NEW YORK

High Grade but not High Priced

BAKER GUNS
Hammer and Hammerless

Built for Hard Service and to last a lifetime



Send for **FREE QUARTERLY** and **1904 Booklet Fully Describing all Grades with Prices.** Mention **RECREATION.**

Baker Gun & Forging Co., No. 42 Liberty St. **Batavia, N. Y.**

No Rifle complete unless mounted with one of our

IMPROVED TELESCOPIC OUTFITS

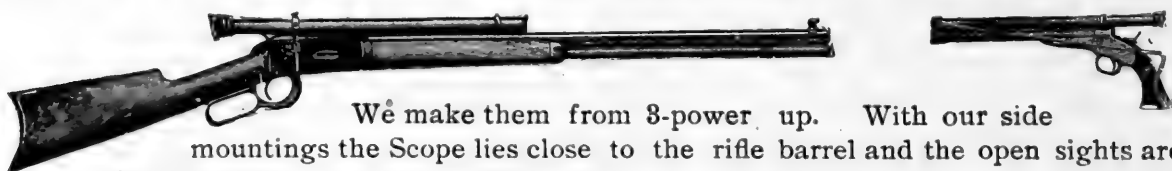

We make them from 3-power up. With our side mountings the Scope lies close to the rifle barrel and the open sights are left entirely clear and unobscured.

SEND FOR OUR CATALOGUE

Mention **RECREATION.**

THE MALCOLM RIFLE TELESCOPE MFG. CO.

F. T. CORNISH, Mgr.

Established 1857

SYRACUSE, N. Y., U. S. A.

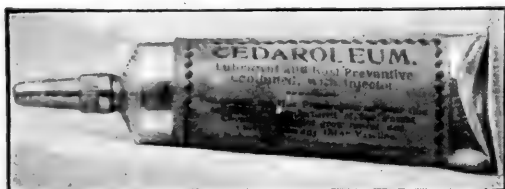

Trade CEDAROLEUM Mark

THE IDEAL CLEANER, LUBRICANT and RUST PREVENTIVE
It is colorless, impervious to atmosphere and salt-water. Will not grow rancid nor evaporate. It has all the qualities of an *up-to-date* firearm lubricant. Once used, always used. One ounce tubes retail at 15c. and two ounce tubes at 25c.; both

sizes have *injecting points.* Will be sent you by mail, if your dealer does not carry it.

Mention **RECREATION.**

CEDAROLEUM COMPANY, Perkinsville, Vt.

I received the J. C. Hand Trap as a premium and am well pleased with it. It works to perfection. Shall get you more new subscribers when I can.

Geo. Hobbs, Elyria, O.

Received the Press Button Knife. It is first class in every respect and an addition of great value to any hunting outfit. I thank you for it.

Arthur Thomson, San Antonio, Tex.



This is the New 9 F. Grade

NEW LEFEVER

It is a plain gun, and sells at a popular price, but has all our latest improvements.

D. M. Lefever, Sons & Co

Not connected with Lefever Arms Company,

Syracuse, N. Y.

Send for
1904
Catalogue
and
Discounts

Mention
RECREATION

The Garrison SHOTGUN ROD and CLEANER

We took up the manufacture of this device only after the most exhaustive tests, which proved to our entire satisfaction that it is absolutely the best shotgun cleaner ever invented. The reasons are that it has greater durability, cleans more rapidly and perfectly, any desired pressure may be applied from chamber to choke, is complete in itself, has no attachments to be taken off or on or to become lost, the pads will



This shows a wood rod. The brass ones are also in 3 joints.

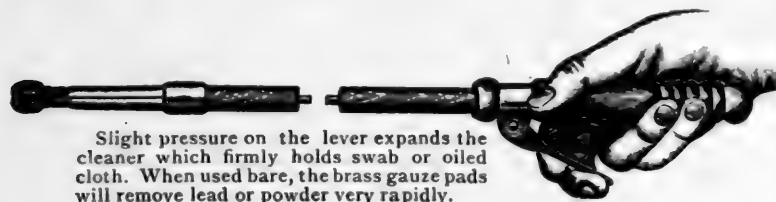

Slight pressure on the lever expands the cleaner which firmly holds swab or oiled cloth. When used bare, the brass gauze pads will remove lead or powder very rapidly.

last for years (new set costs only 10c), you can *feel* every spot of lead or caked powder and work them off, which saves looking through the barrel every minute; rag cannot become stuck in barrel.

These advantages make it a pleasure to clean a gun instead of a trial. Wood rods, plain, 75c; highly finished, \$1.00; brass tube rods, \$1.25; nicked, \$1.50. Send for one, use it 30 days. If not satisfactory return and get your money back. Sold by dealers or direct, prepaid. Send for 1904 catalog showing 18 new specialties.



Showing the 3 cleaner pads partly expanded. Each pad is made by stringing 30 brass gauze washers on a holder and compressing to shape shown.

Mention RECREATION.

Marble Safety Axe Co., Dept. A., Gladstone, Mich

Among my latest prizes from RECREATION I must mention the Safety pocket axe and Ideal knife made by the Marble Safety Axe Co., Gladstone, Mich. I think they are the neatest and best things a hunter ever owned, a credit to the maker, the giver and the receiver. It's needless to say that I thank you for them.

H. H. Dean, Leavenworth, Wash.

The Weno Hawkeye camera was received in due time. I am very much pleased with it.

C. E. Hinkly, Royal, Pa.

The teacher had been showing pictures of some Italian buildings.

"Now, Johnny, you describe a typical building of Italy," she said.

"Well," he answered, hesitatingly. "the leaning tower of Pisa is the most typical one you've shown us."—Little Chronicle.

Sportsman's cabinet arrived in perfect order. Words can not express my appreciation for your promptness in forwarding this most valuable premium.

T. W. Hinke, Union Hill, N. J.

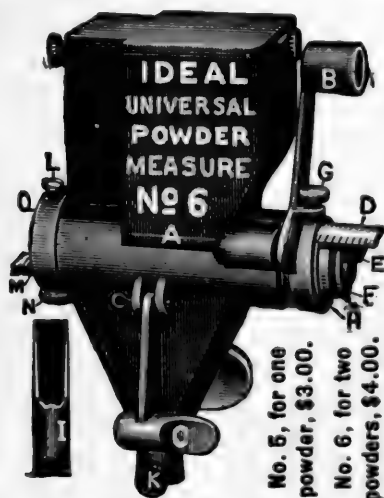

No. 5, for one powder, \$3.00.
No. 6, for two powders, \$4.00.

POWDER! POWDER!

All kinds of powder for **Rifles, Pistols** and **Shot Guns**, **measured accurately** from 1 to 145 grains. 4 different measures in 1. The latest and best tool. Ask your dealer for it.

Every shooter should have 1. Send 3 stamps for **Ideal Hand Book**, 146 pages of information to shooters.

IDEAL MFG. CO., 120 St., New Haven, Conn., U. S. A.

The PHIL B. BEKEART CO., of San Francisco, Cal., Agents for Pacific Coast

When you write kindly mention RECREATION

TO AMATEUR PHOTOGRAPHERS

Here is a Chance
to Get a
FINE CAMERA EASILY

A 4x5 Weno Hawk-eye film camera listing at \$8, for 5 yearly subscriptions to RECREATION. A No. 3 folding Weno Hawk-eye film camera, listed at \$15, for 10 yearly subscriptions to RECREATION.

These are both neat, compact, well-made and handsomely finished cameras, capable of doing high-class work.

*Sample copies for use in canvassing
furnished on request.*

Address RECREATION

23 West 24th St.

NEW YORK.

*No. 1
Special*

\$21.⁰⁰



No. 4

List \$100

WRITE FOR
1904 ART CATALOG

AND

Special Prices on 16 Grades Guns \$17.75 to \$300.

Mention RECREATION.

ITHACA GUN COMPANY

Ithaca, New York

Do
You
Want
a
Lens?

If so, why not get a good one?

And why not get it free of charge?

This is easy.

Any old box will answer the purpose if it does not leak light; but you must have a fine lens to make a fine picture.

YOU CAN GET

**A Royal Anastigmat
Lens, 4x5, Series No. 1,**

**Made by the
Rochester Lens Co., Rochester, New York**

**And listed at \$45, for 15 yearly sub-
scriptions to RECREATION**

You can get any other lens made by this Company on a basis of one subscription to \$3 of the list price of the lens.

Sample copies of RECREATION for use in soliciting furnished on application.

One of the 9

Built for Business

“A” GRADE \$80 LIST

In offering this gun to the public, we have combined
ALL OF THE DISTINCTIVE IMPROVEMENTS
 which have gained for the “Syracuse” its present prominent position
 among American Arms.

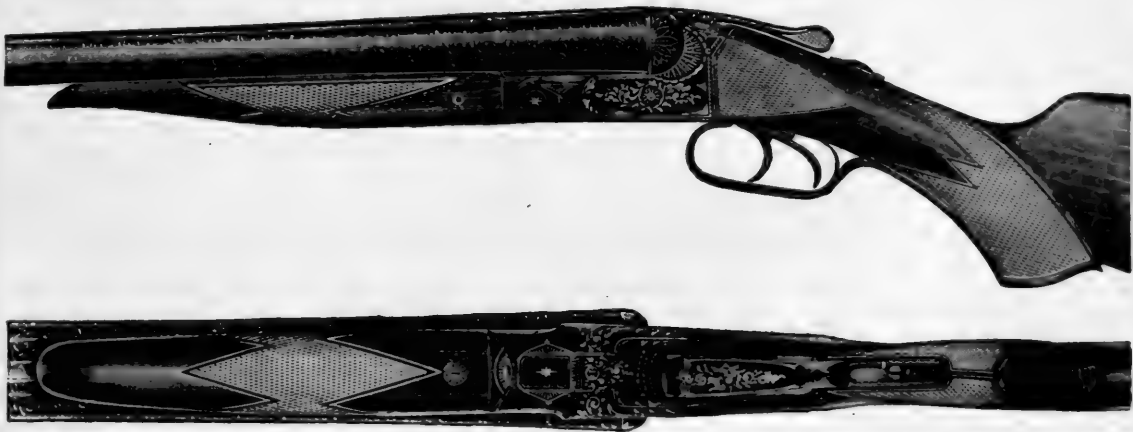

“A” GRADE

Condensed Description.

BARRELS—Fine quality of Damascus Steel, or if desired, we will furnish Krupp Fluid Pressed Steel Barrels, made at the Krupp Works, Essen, Germany, and imported to our order.

STOCK—Imported Italian Walnut, finely figured and dark rich color. Full pistol or Straight Grip as desired.

AUTOMATIC EJECTOR—With our Patent Non-Ejector device which allows the gun to be instantly changed from an Automatic to a Non-Automatic Ejector.

This model gun is handsomely engraved and cleanly finished, and will compare favorably with any gun on the market listing at \$100.00.

All “Syracuse” guns for 1904 will be built with our New Compensating Double Cross Bolt; and Frames Inletted into Stock, thus preventing the spreading or splitting of same.

Catalogue yours for the asking. Mention “Recreation.”

SYRACUSE ARMS CO. SYRACUSE, N. Y.

**H. & R.
"Bicycle
Hammerless"
Revolver**



Description

32 Caliber, 5 shot. 2 inch Barrel. Weight, 12 ounces.
C. F., S. & W. Cartridge. Finish, Nickel or Blue.

Impossible to catch on the pocket and discharge accidentally.

Absolutely Safe. Although designed for cyclists, this revolver is equally adapted to all cases where a small, light weight, effective and handy pocket weapon is desired. It has a small frame and automatic ejector. Sold direct where dealers will not supply.

Mention RECREATION when writing.

HARRINGTON & RICHARDSON ARMS CO.

Makers of H. & R. SINGLE GUNS

Catalog for Postal
Dept. R.

WORCESTER, MASS.

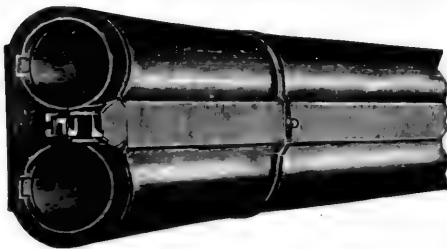

Bradley's Attachable Rear Sight

Makes the aim true and quick. Prevents over and under shooting. It will improve the score. Instantly attachable and detachable. No tools required to adjust to your gun, and it will not mar the barrel. Fits any gun. One sight will do for all your guns. Once used it will never be discarded. It is made of the best spring steel, nicely finished. **Price, postpaid, \$1.00.** Send for descriptive circular.

Mention RECREATION.

C. L. BRADLEY, - Clarksville, Tenn.

**P
A
T
E
N
T
S**

Correspond with H. Haupt, Jr., Patent Attorney and Counsellor, 55 Liberty St., New York, when you want a patent or information regarding patents.

Mention RECREATION.

Vegetarian—Don't you know the strongest animals are all vegetarians, the elephant being the most powerful?

Carnivorous Friend—That's all right. If they weren't so strong they never would be able to stand a vegetable diet.—Boston Transcript.

**Hammerless Double
Our Latest
"DAVENPORT"**

**Strictly
High
Grade**



Send for Catalogue
Mention RECREATION.

**The W. H. Davenport Fire Arms Co.
NORWICH, CONN.**

SAVAGE RIFLES
exclusively adopted
at the
St. Louis World's Fair

Visit
"Hunting in
the Ozarks"

See
Coupon



Tear off this Coupon

Exchange it at our exhibit,
St. Louis World's Fair,
Manufacturers' Building,
Space 9B,
for a ticket entitling you to
the free use of a

SAVAGE RIFLE

at the famous
shooting gallery
"Hunting in the Ozarks,"
G. on the Pike.

SAVAGE RIFLES

DISCRIMINATING SPORTSMEN are enthusiastic over the many novel features of the **SAVAGE 22 CALIBER REPEATER**. It is hammerless, shoots the short, long and long rifle cartridges all in the same arm, and its accuracy alone has placed it in a class by itself. Remember that Savage Repeating Rifles are made for all kinds of shooting—and also bear in mind we can give you some practical hints on the choice of an arm. At any rate let us send you our catalogue & Correspondence solicited.

Savage Arms Co., Utica, N. Y., U. S. A.

Baker & Hamilton, San Francisco and
Sacramento, Cal., Pacific Coast Agents.

I beg to acknowledge, with thanks, the receipt of the hunting boots you sent me as a premium for subscriptions to your valuable magazine. In material and workmanship they are the finest I have ever seen; I could not wish for a better premium.

Charles Engler, Erie, Pa.

Teacher—How many trips did Columbus make to the New World?

Mary—Three, mum.

Teacher—And after which one of these did he die?—Foolish Book.

I am delighted with RECREATION and to read each issue is like a happy dream.

W. S. Cleveland, Medford, Wis.

AN IMPORTANT OFFER

For 2 Yearly Subscriptions to RECREATION

I will send you

A RIFLE WICK PLUG

Made by HEMM & WOODWARD, Sidney, Ohio, 30 caliber up to 50 caliber.

OR

A SHOT GUN WICK PLUG

20 gauge up to 10 gauge

For 3 Yearly Subscriptions to RECREATION

A Pair of Shot Gun Wick Plugs

20 to 10 gauge.

Sample copies for use in canvassing furnished on application.

Address RECREATION, 23W. 24th St., N. Y. City

SAY!

When you have a gun in mind,
Be sure you get the proper kind;
Don't take the other "Just as good,"
But call for PARKER as you should.

There is **NO** gun just as good as the **Parker**; we have had over 40 years' experience making Shot Guns, and have never made any other than "the Parker Gun," and it stands today as the **best gun** in the world, where it has always stood. Ask your Grandfather what he thinks. If you want a gun to shoot, to wear, to fit, to handle gracefully, and to be a source of satisfaction, buy the **PARKER** and **NO OTHER**.

Send for Catalogue.

N. Y. Salesrooms
32 Warren Street

Mention RECREATION.

PARKER BROS.
MERIDEN, CONN.

Another Great Offer to Amateur PHOTOGRAPHERS

A 4x5 SERIES 1 KORONA

Listed at \$12.50, for 8 yearly subscriptions to RECREATION.

A 5x7 SERIES 1 KORONA

Listed at \$18, for 12 yearly subscriptions.

A 4x5 SERIES 2 KORONA

Listed at \$18.50 for 14 yearly subscriptions.

A 4x5 SERIES 3 KORONA

Listed at \$21 for 18 yearly subscriptions.

A 4x5 SERIES 4 KORONA

Listed at \$25, for 20 yearly subscriptions.

A 4x5 SERIES 5 KORONA

Listed at \$36, for 30 yearly subscriptions.

A 4x5 CYCLE POCO, No. 3

Listed at \$15, for 12 yearly subscriptions.

A 4x5 CYCLE POCO, No. 6

Listed at \$12.50, for 8 yearly subscriptions.

A 4x5 POCKET POCO B

Listed at \$10.50, for 6 yearly subscriptions.

A 4x5 PONY PREM0, No. 4

Listed at \$24, for 20 yearly subscriptions.

Sample Copies for use in Canvassing
Furnished Free

ADDRESS

RECREATION

23 W. 24th St., New York City



Only one
POWDER

Has more penetration and less recoil
 than all others, and it has
 been proved by comparative tests that

Robin Hood

is the ONE.

LOADED ONLY IN
 Robin Hood and Comet Shells

Manufactured by

The Robin Hood Powder Co.

Swanton, Vt.

Mention RECREATION.

FOR WRITE UPS
 FOR POWDER FACTS

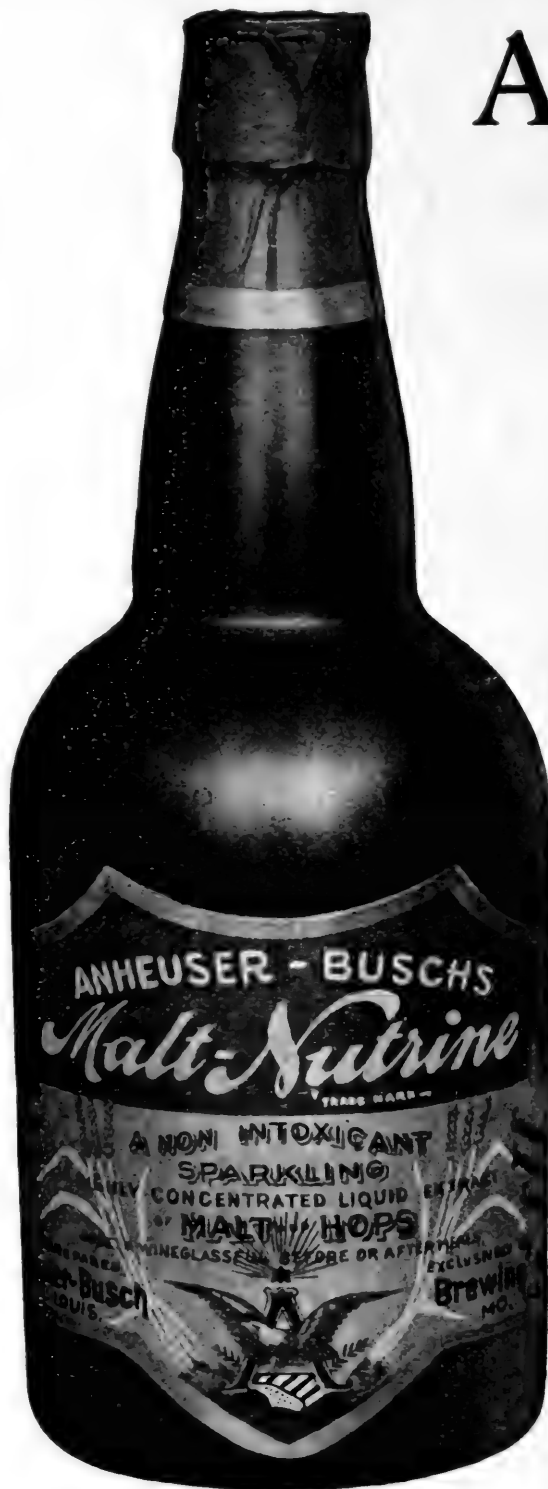

Appetite Health Vigor

ANHEUSER-BUSCH'S
Malt-Nutrine
TRADE MARK.

is invaluable to nursing mothers, feeble children, the aged, infirm and convalescent and its use brings appetite, health and vigor.

Malt-Nutrine is not an alcoholic beverage, but a predigested food in liquid form, easily assimilated by the weakest stomach.

Malt-Nutrine is sold by all druggists and grocers. Served at all health resorts and summering places.

Prepared only by the

Anheuser-Busch Brewing Ass'n

St. Louis, U.S.A.

Also brewers of **Budweiser**, the
World's Most Famous Bottled Beer.

World's Fair Visitors are cordially invited to inspect the Anheuser-Busch Brewery

LOS ANGELES--Four Days from New York by NEW YORK CENTRAL, Boston--by NEW YORK CENTRAL,



All over the civilized world
THE IMPROVED
BOSTON
GARTER
 IS KNOWN AND WORN
 Every Pair Warranted
 The Name is stamped on every loop—
 The *Velvet Grip*
CUSHION
BUTTON
CLASP
 Lies flat to the leg—never Slips, Tears nor Unfastens
ALWAYS EASY
 Send 50c. for Silk, 25c. for Cotton, Sample Pair.
GEO. FROST CO., Makers,
 Boston, Mass., U. S. A.
 REFUSE ALL SUBSTITUTES

The Rational Vehicles of Health and Pleasure

Bicycles

Equipped with
Two-Speed Gear
 and
Coaster Brake

The return of bicycling finds our American roads greatly improved and the bicycle itself perfected in design and construction and equipped with new and marvelous devices.

To learn all about modern bicycles, get catalogues free from our 10,000 dealers, or send stamp for any one of them.

Pope Manufacturing Co.

EASTERN DEPARTMENT: Hartford, Conn.		WESTERN DEPARTMENT: Chicago, Ill.	
"Columbia"	"Cleveland"	"Rambler"	"Monarch"
"Tribune"	"Crawford"	"Crescent"	"Impart"

You See Them Everywhere



Say!!
 do you know even farmers with their healthy out-door life are often seriously hurt by

COFFEE?

It's a fact. Ask any regular coffee drinker if he is *entirely well*. Few, if any, are, because coffee congests the liver and causes all sorts of nervous and stomach troubles. It's easy to prove by quitting and taking on **POSTUM FOOD COFFEE**.

A return to health is natural and very sure unless other troubles interfere.

"There's a reason" for

POSTUM

ED. PINAUD'S



EAU DE QUINA
HAIR TONIC

Is the best HAIR RESTORER known. It is also a positive CURATIVE, as well as a most excellent HAIR DRESSING. The odor which it leaves in the hair makes it a toilet luxury. 4 oz. bottle, \$1.00.

ED. PINAUD'S
 LATEST EXQUISITE PERFUME
BRISE EMBAUMÉE VIOLETTE
 Is admitted by connoisseurs to be the most delicate embodiment of the odor ever produced. 1 oz. bottle, \$2.00. Sold everywhere, \$4.00; or, if not obtainable of your dealer write to **ED. PINAUD'S AMERICAN OFFICES,** ED. PINAUD

VOSE

PIANOS have been established over 50 YEARS. By a system of payments every family in moderate circumstances can own a **VOSE** piano. We make old instruments in exchange and deliver the new piano in your home free of charge. Write for catalogue D and explanations.

VOSE & SONS PIANO CO., 160 Boylston St., Boston, Mass.

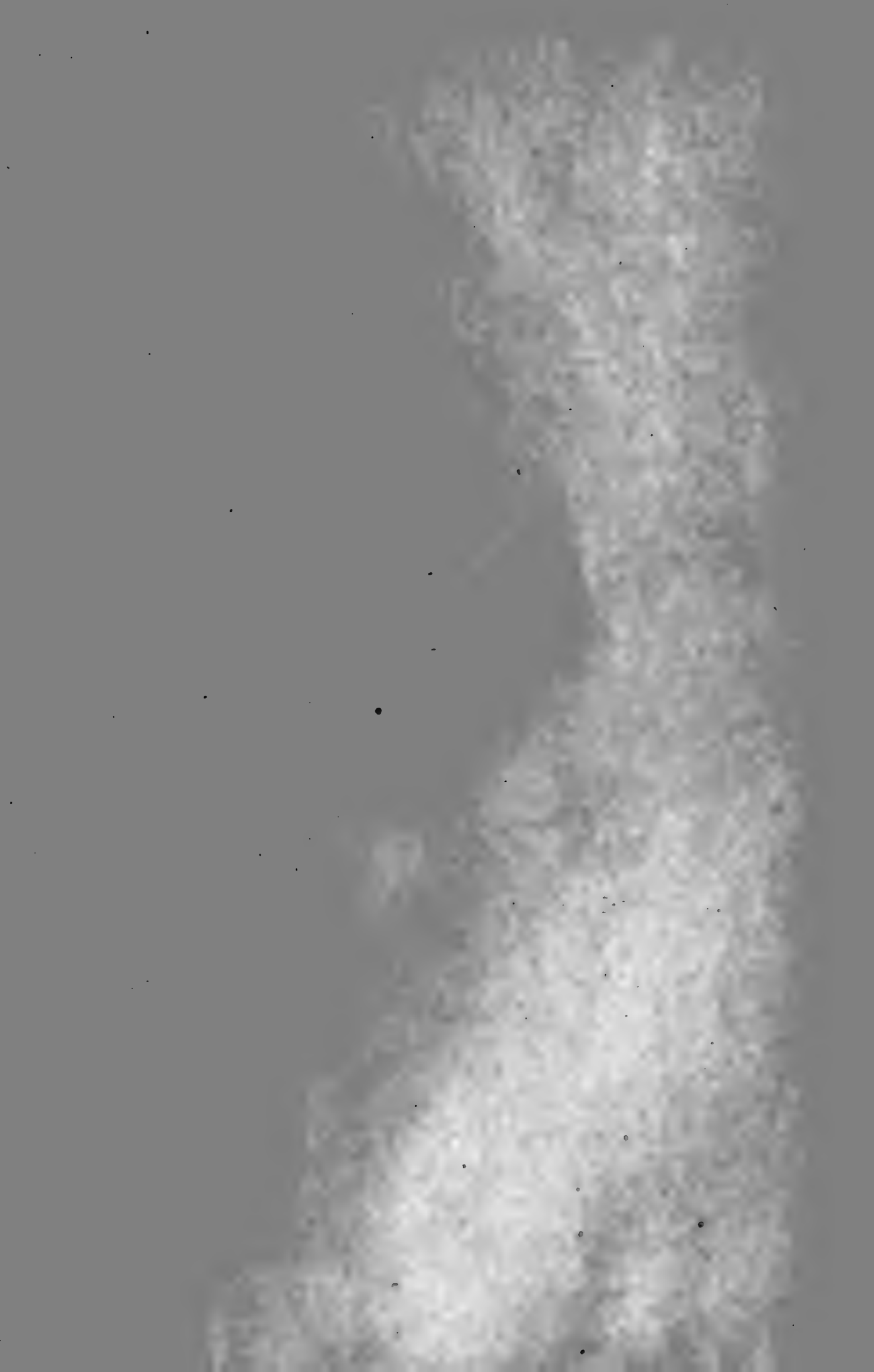







3 2044 106 225 196

